



US00D567462S

(12) **United States Design Patent**
Renault et al.

(10) **Patent No.:** **US D567,462 S**

(45) **Date of Patent:** **** Apr. 22, 2008**

(54) **STEAM IRON**

(75) Inventors: **Fabrice Renault**, Lyons (FR); **Arnaud Grienay**, Lyons (FR)

(73) Assignee: **Calor**, Lyons (FR)

(**) Term: **14 Years**

(21) Appl. No.: **29/282,439**

(22) Filed: **Jul. 20, 2007**

(30) **Foreign Application Priority Data**

Feb. 7, 2007 (FR) 07 0637

(51) **LOC (8) Cl.** **07-05**

(52) **U.S. Cl.** **D32/70**

(58) **Field of Classification Search** D32/68-72;
38/74-75, 77.1-77.9, 88, 90, 93; 219/245-248,
219/252

See application file for complete search history.

(56) **References Cited**

U.S. PATENT DOCUMENTS

2,398,579	A *	4/1946	Clark et al.	38/90
D315,433	S *	3/1991	Chen	D32/68
D402,779	S *	12/1998	Gudefin	D32/70
D459,562	S *	6/2002	Page et al.	D32/70
D468,070	S *	12/2002	Fujita et al.	D32/70
D485,035	S *	1/2004	Schupp	D32/70
D488,275	S *	4/2004	Gudefin	D32/70
D501,692	S	2/2005	Powell		
D541,502	S	4/2007	Powell		

FOREIGN PATENT DOCUMENTS

WO DM/066028 11/2004

OTHER PUBLICATIONS

Design Registration No. 000249982-0001, published on Feb. 8, 2005, entitled "Steam Irons with Steam Boilers" in the name of Calor, (with English translation) 7 pgs.

Design Registration No. 000412333-0001, published on Nov. 7, 2006, entitled "Steam Irons with Steam Generators" in the name of Calor, (with English translation) 8 pgs.

(Continued)

Primary Examiner—Pamela J. Burgess

(74) *Attorney, Agent, or Firm*—Oblon, Spivak, McClelland, Maier & Neustadt, P.C.

(57) **CLAIM**

The ornamental design for a steam iron, as shown and described.

DESCRIPTION

FIG. 1 is a front, left, top perspective view of a steam iron, showing our new design in a closed heel position;

FIG. 2 is a front, left, top perspective view thereof, in an alternate, opened heel position;

FIG. 3 is a rear, left, top perspective view thereof, in the opened heel position;

FIG. 4 is a left view thereof; in the closed heel position;

FIG. 5 is a left view thereof, in the opened heel position;

FIG. 6 is a right view thereof, in the closed heel position;

FIG. 7 is a right view thereof, in the opened heel position;

FIG. 8 is a front view thereof, in the closed heel position;

FIG. 9 is a front view thereof, in the opened heel position;

FIG. 10 is a rear view thereof, in the closed heel position;

FIG. 11 is a rear view thereof; in the opened heel position;

FIG. 12 is a top plan view thereof, in the closed heel position;

FIG. 13 is a top plan view thereof, in the opened heel position;

FIG. 14 is a bottom plan view thereof, in the closed heel position; and,

FIG. 15 is a bottom plan view thereof, in the opened heel position.

1 Claim, 15 Drawing Sheets

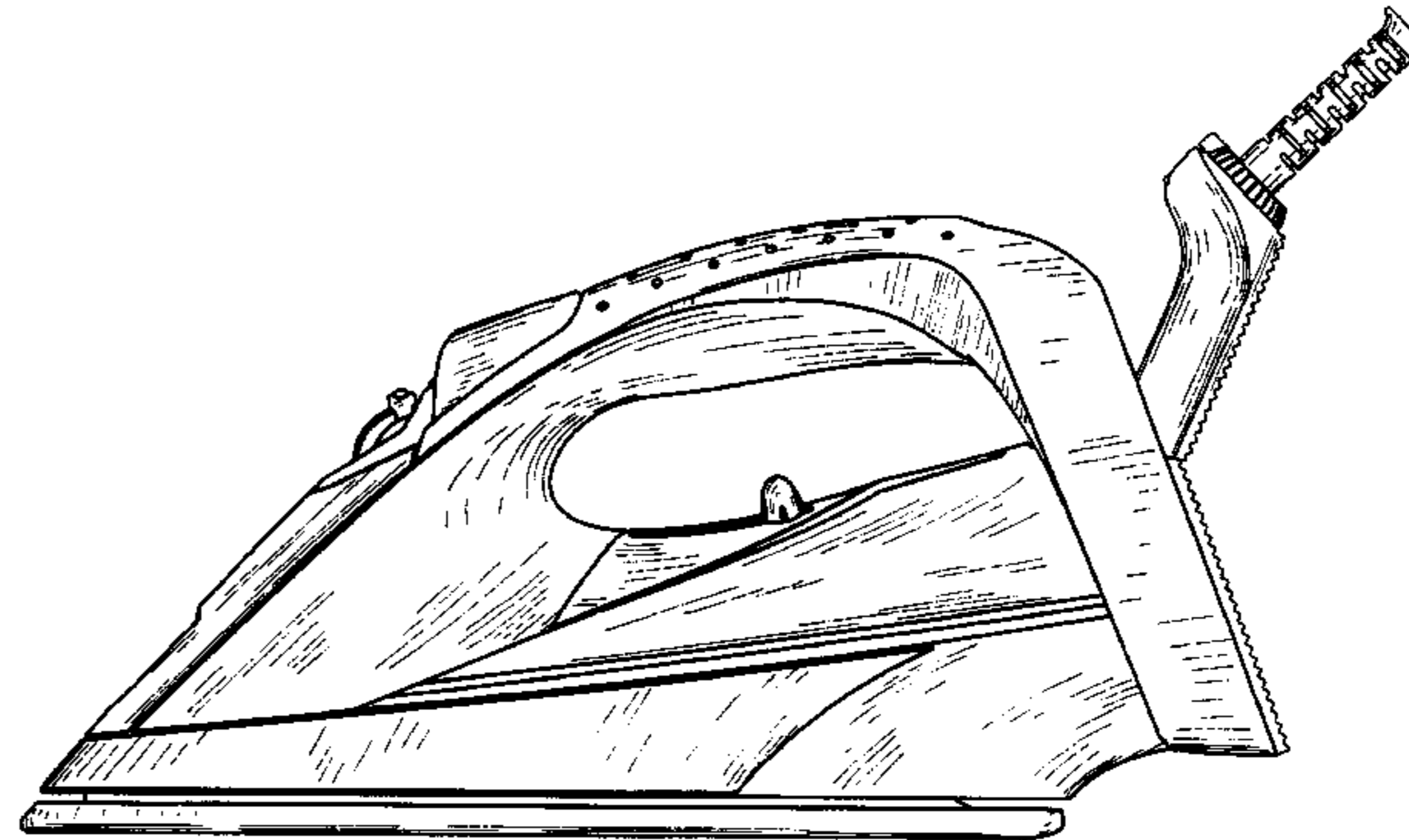
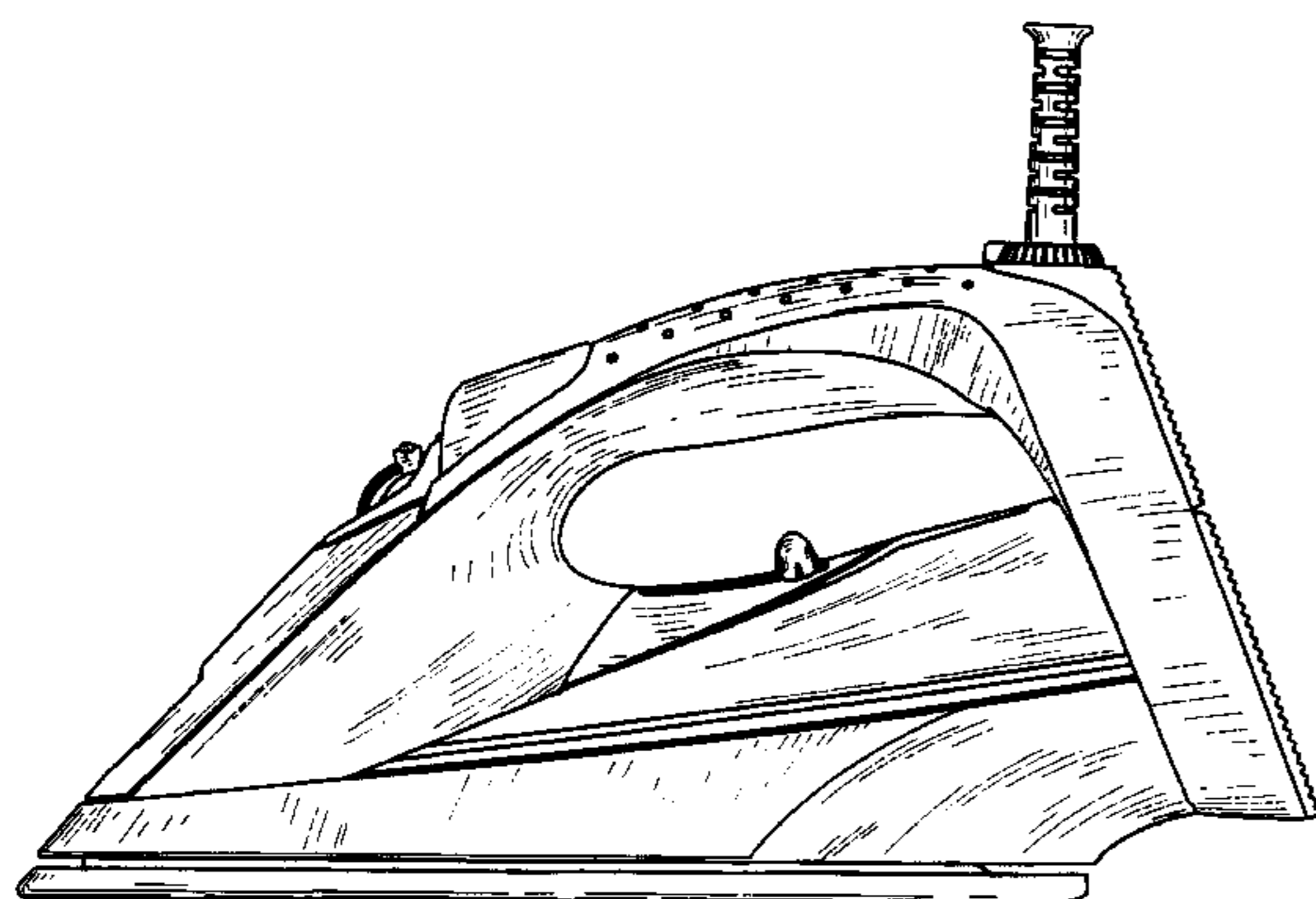

US D567,462 S

Page 2

OTHER PUBLICATIONS

Design Registration No. 000485883-0001, published on Nov. 7, 2006, entitled "Steam Irons" in the name of Calor, (with English translation) 7 pgs.

Design Registration No. 000485875-0001, published on Nov. 7, 2006, entitled "Steam Irons" in the name of Calor (with English translation), 7 pgs.

U.S. Appl. No. 29/275,825, filed Jan. 8, 2007, Renault.

U.S. Appl. No. 29/282,439, filed Jul. 20, 2007, Renault, et al.

* cited by examiner

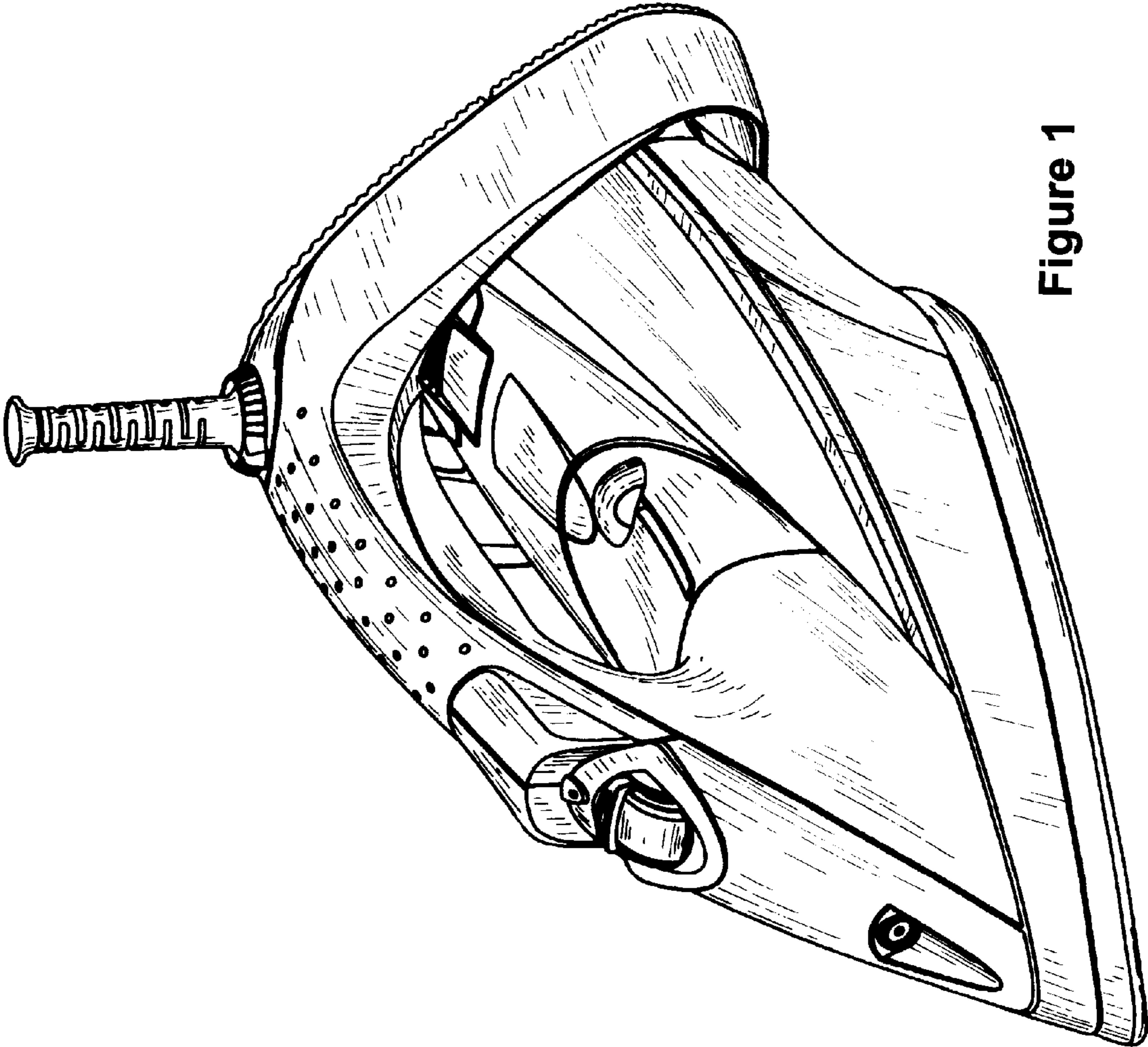

Figure 1

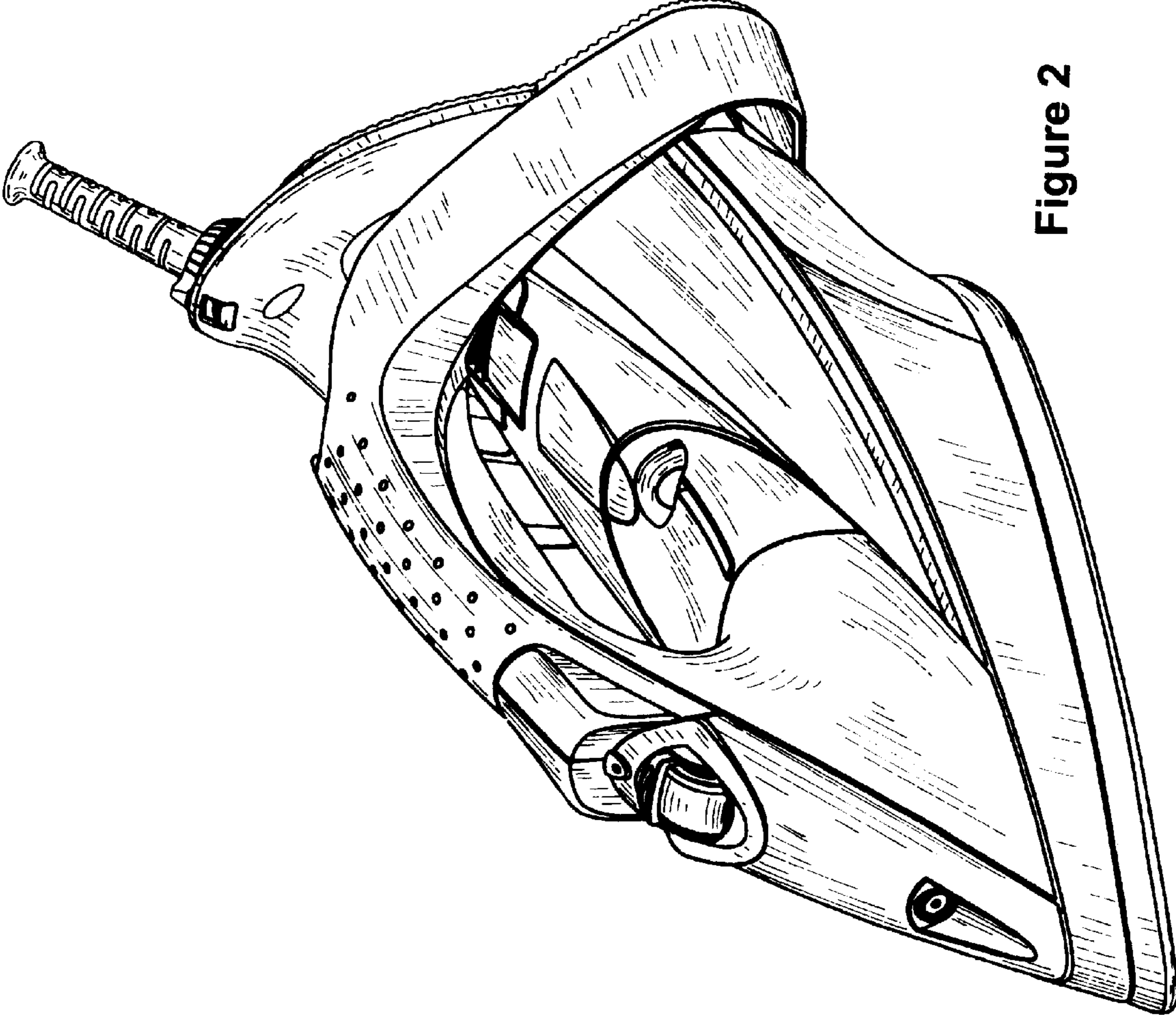

Figure 2

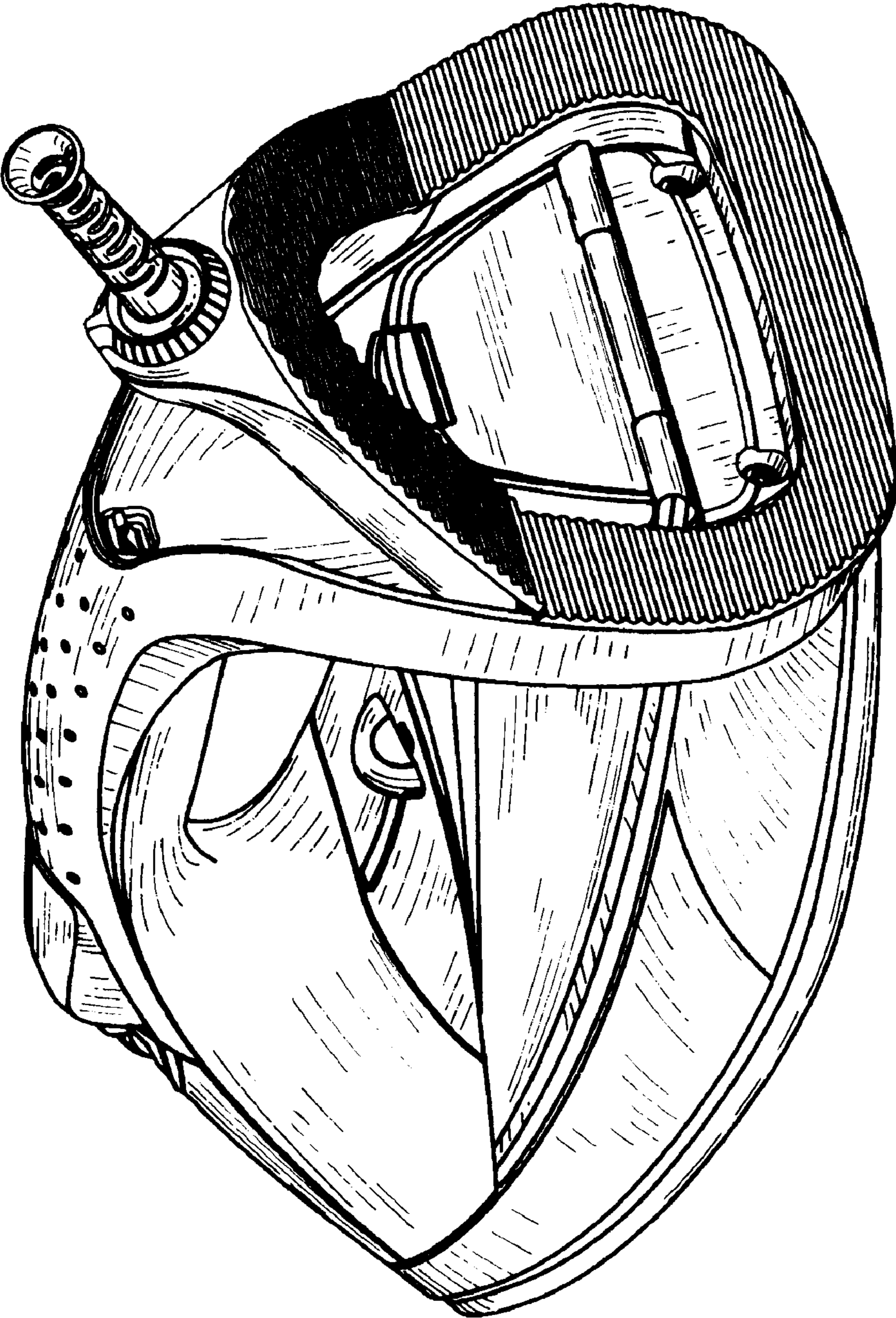

Figure 3

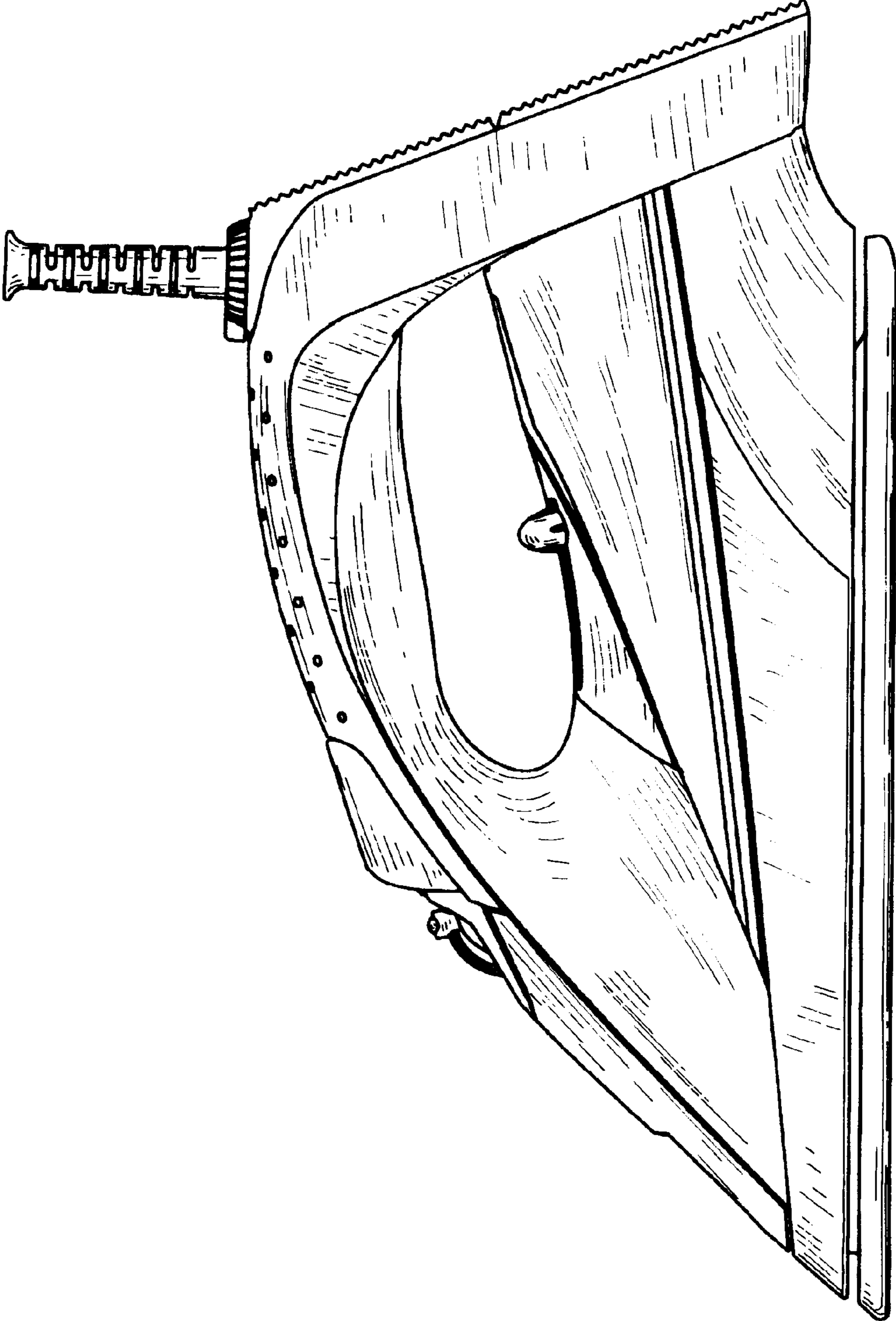

Figure 4

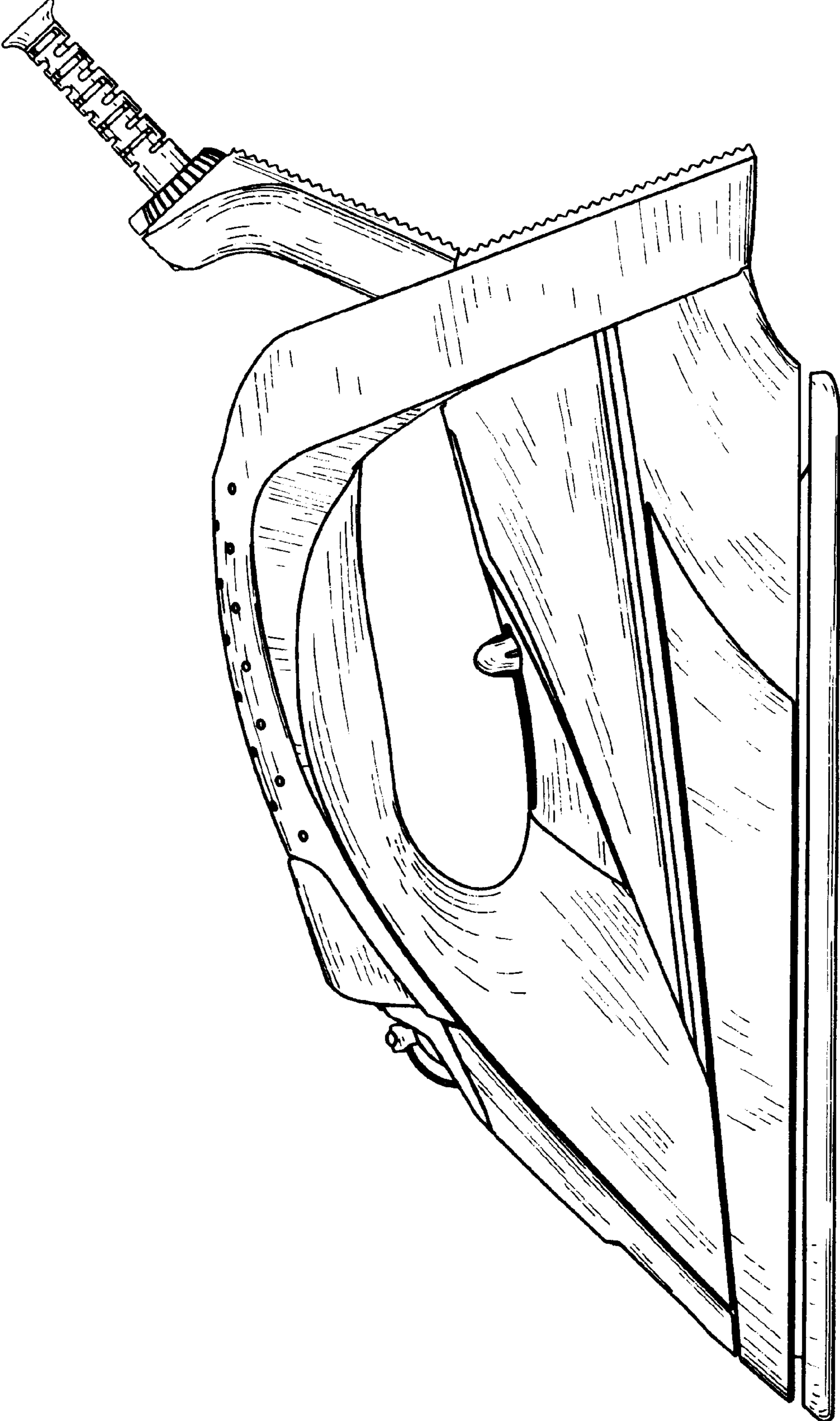

Figure 5

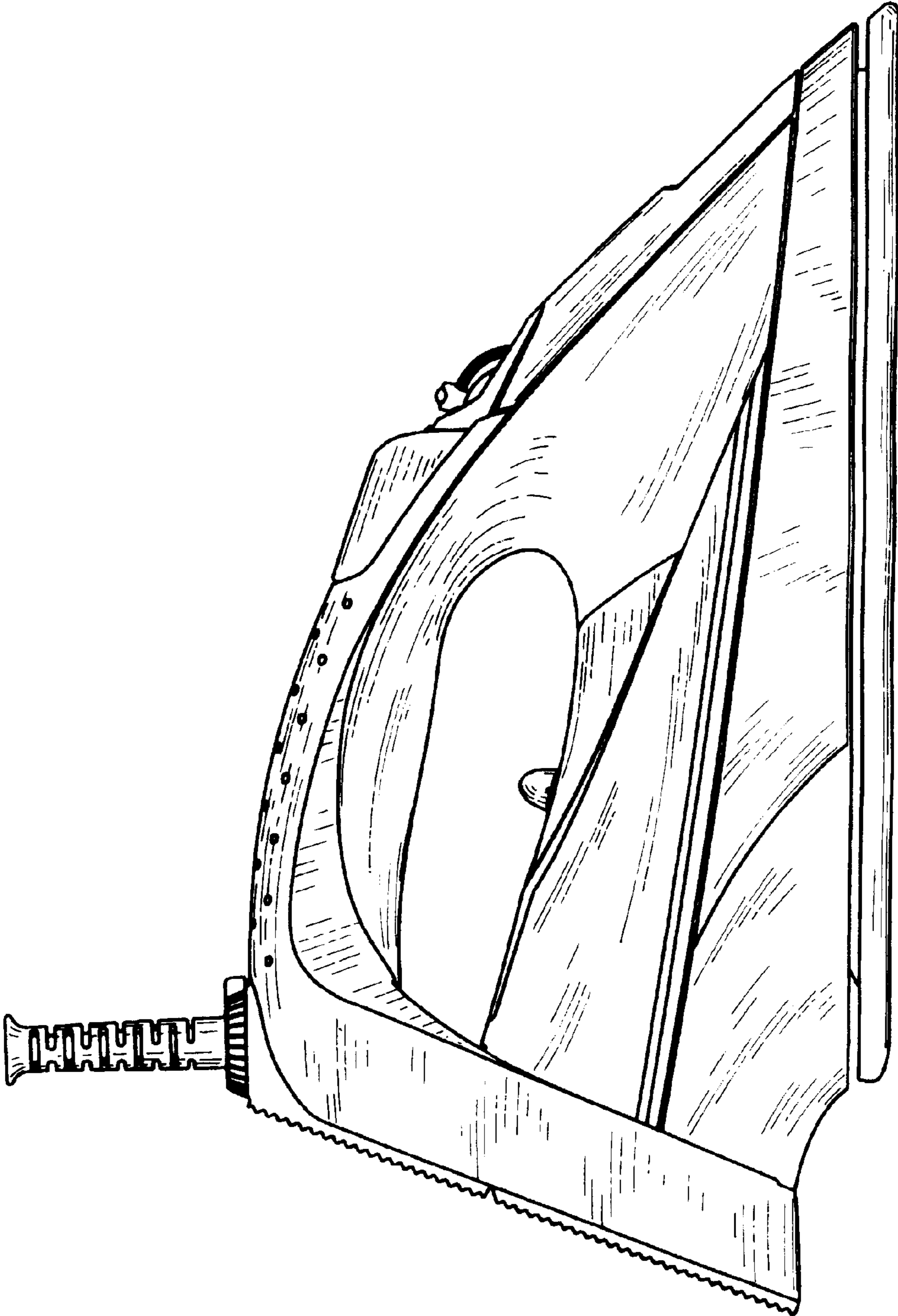

Figure 6

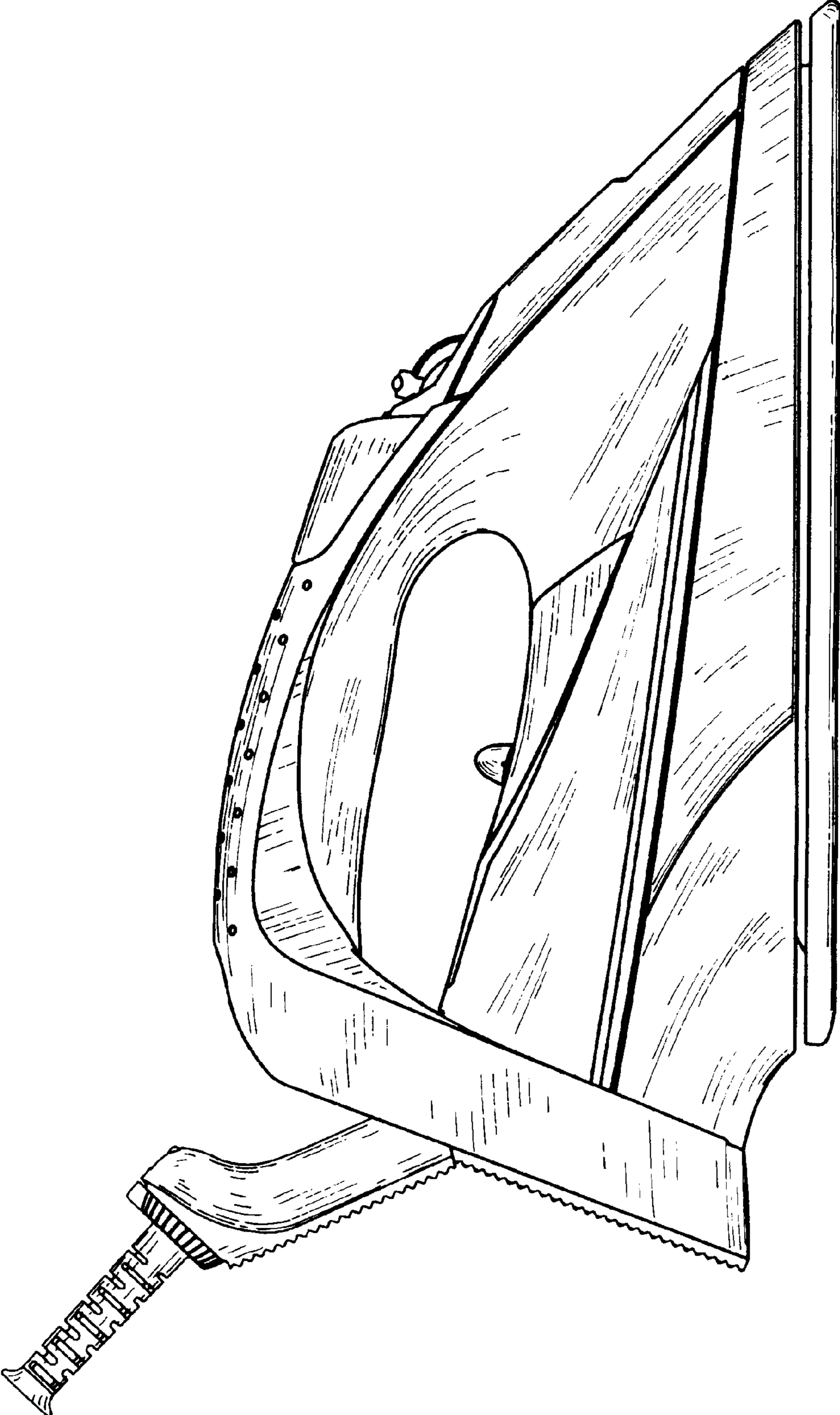

Figure 7

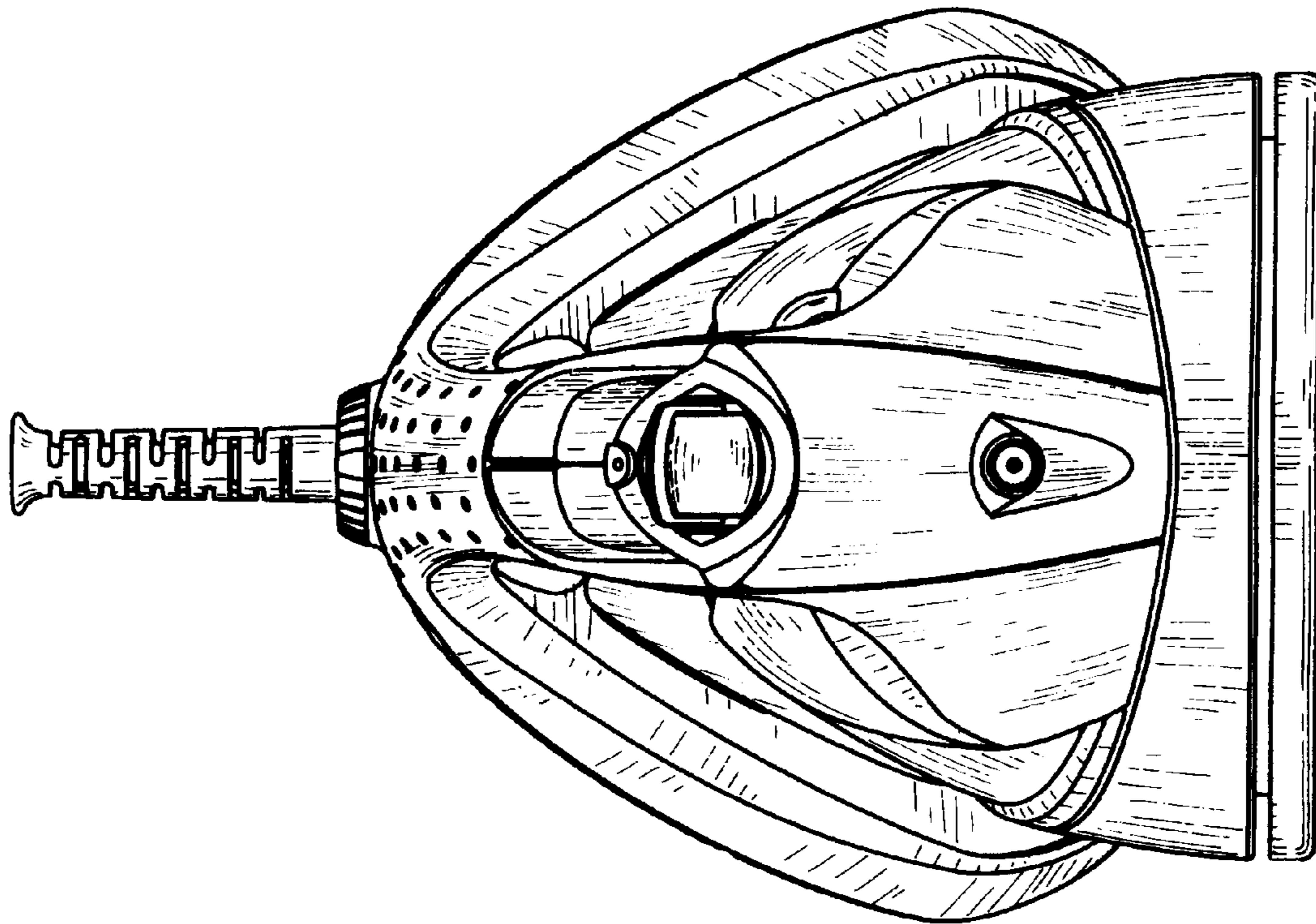

Figure 8

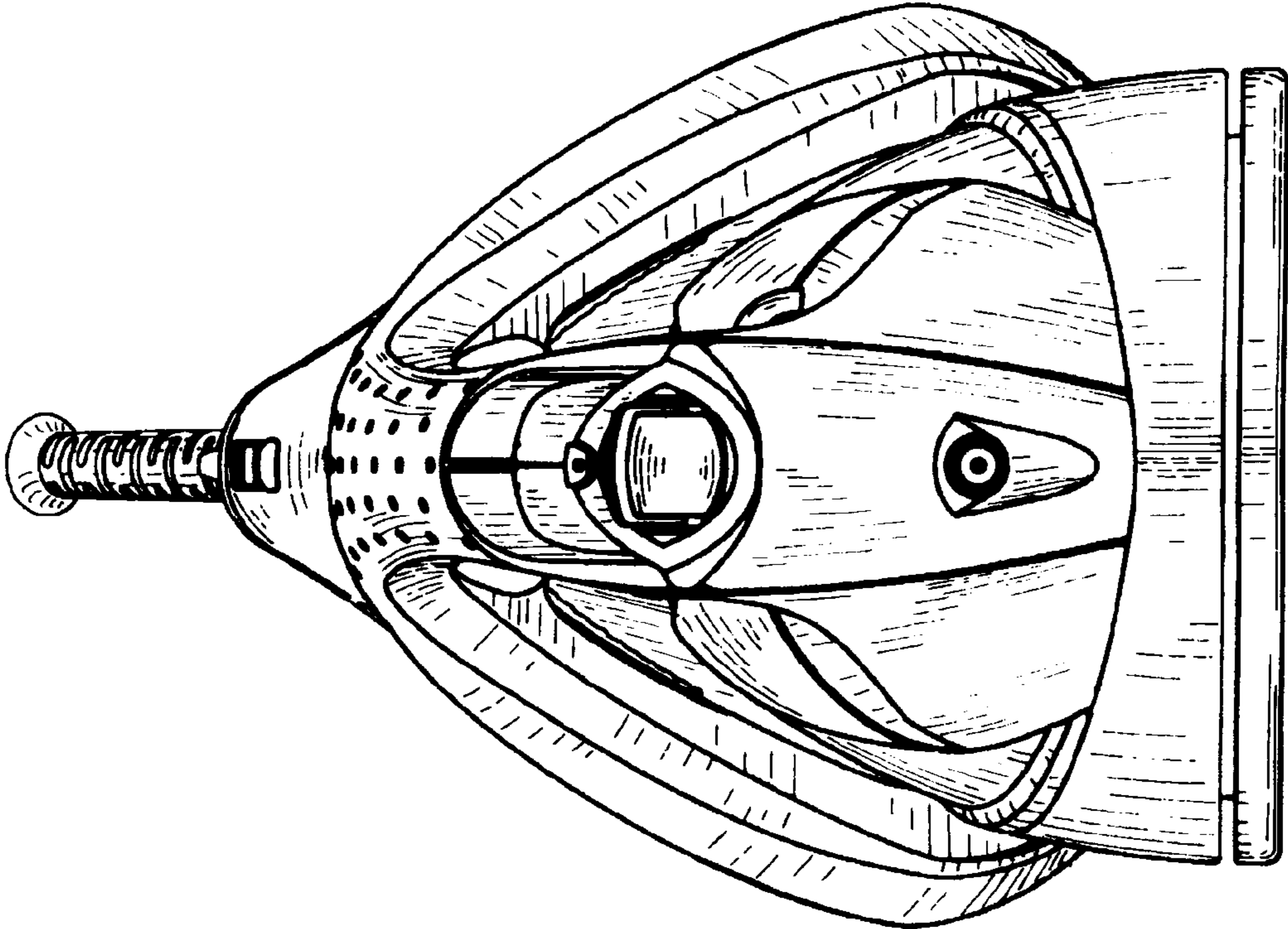

Figure 9

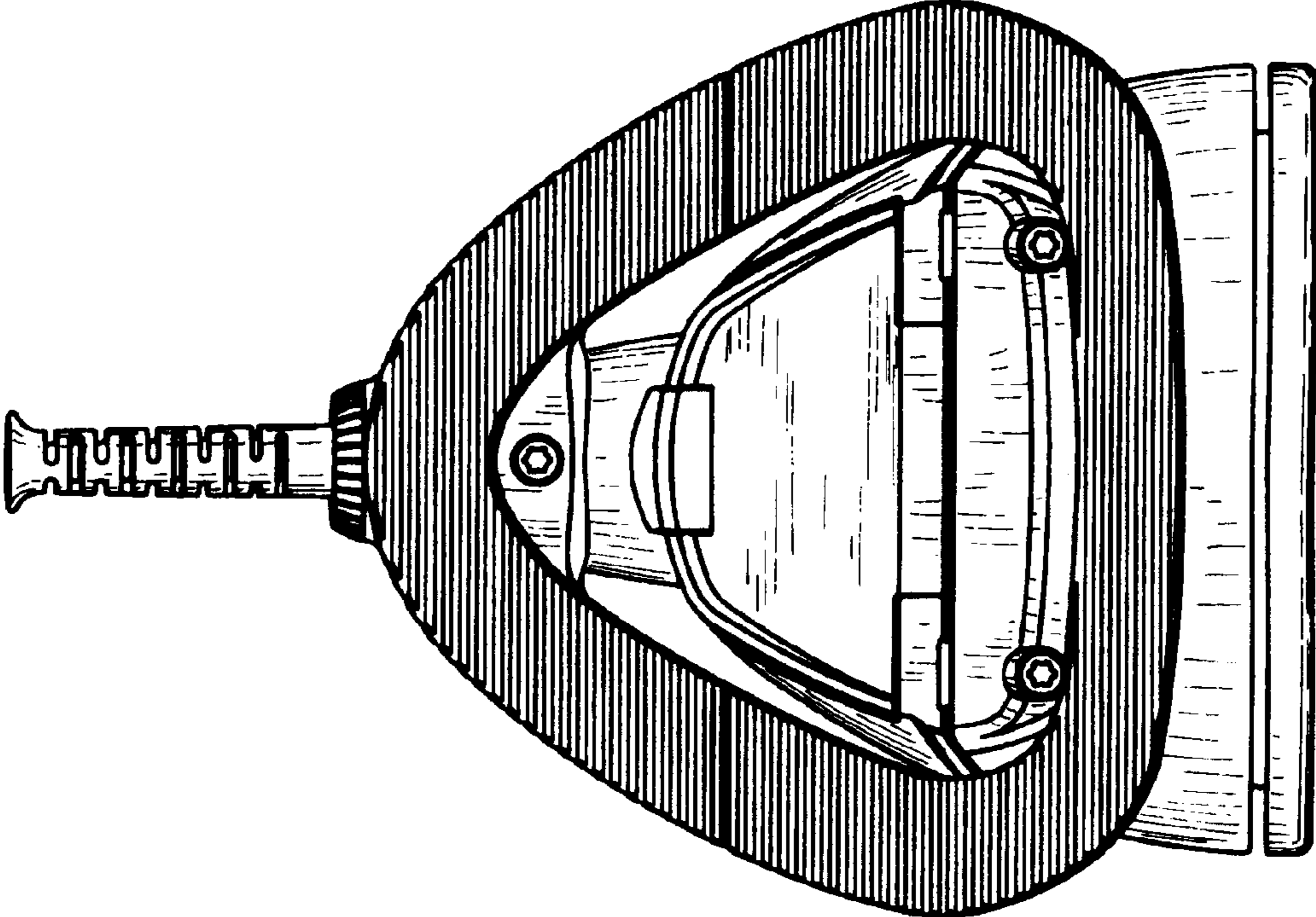

Figure 10

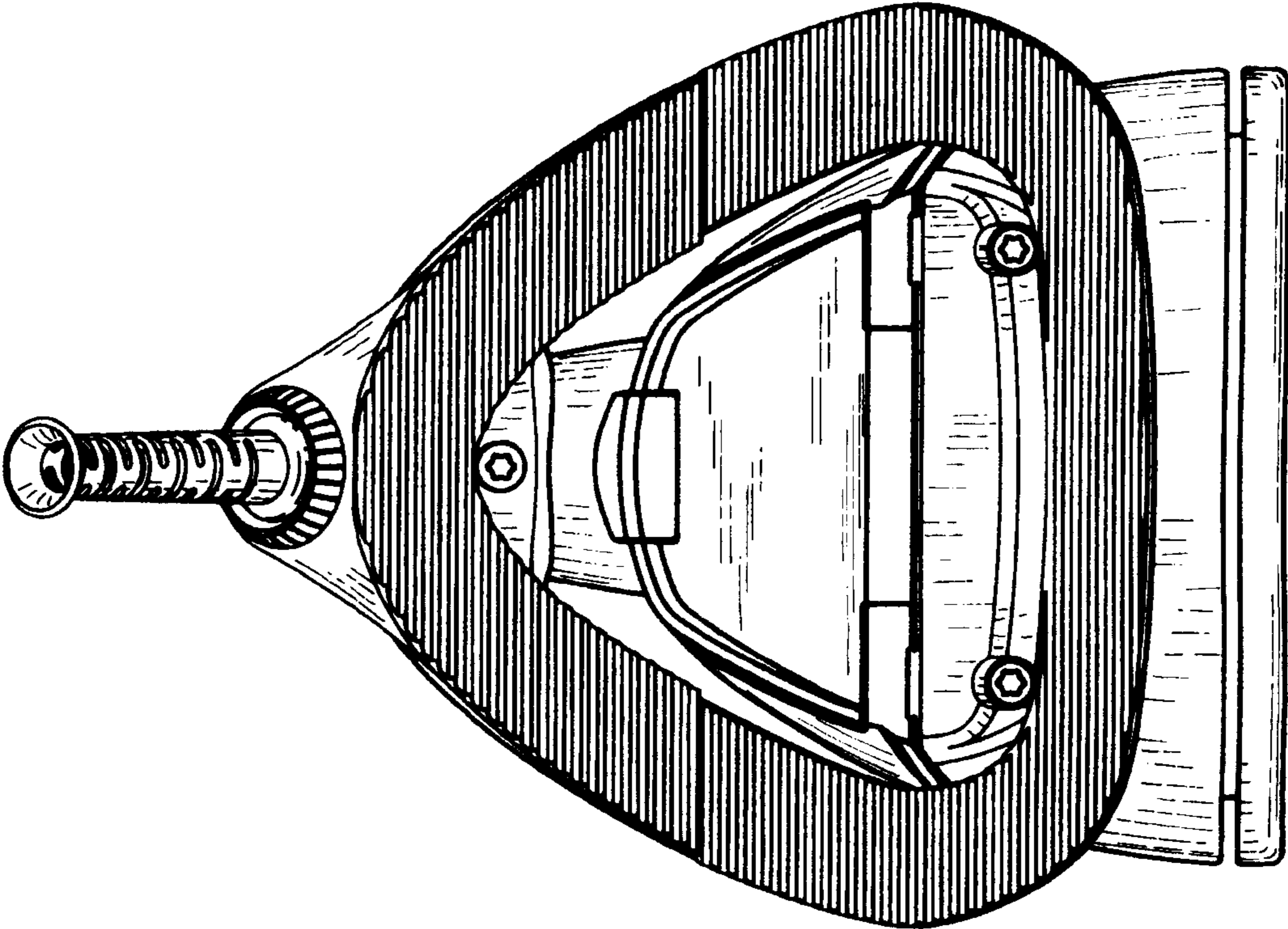

Figure 11

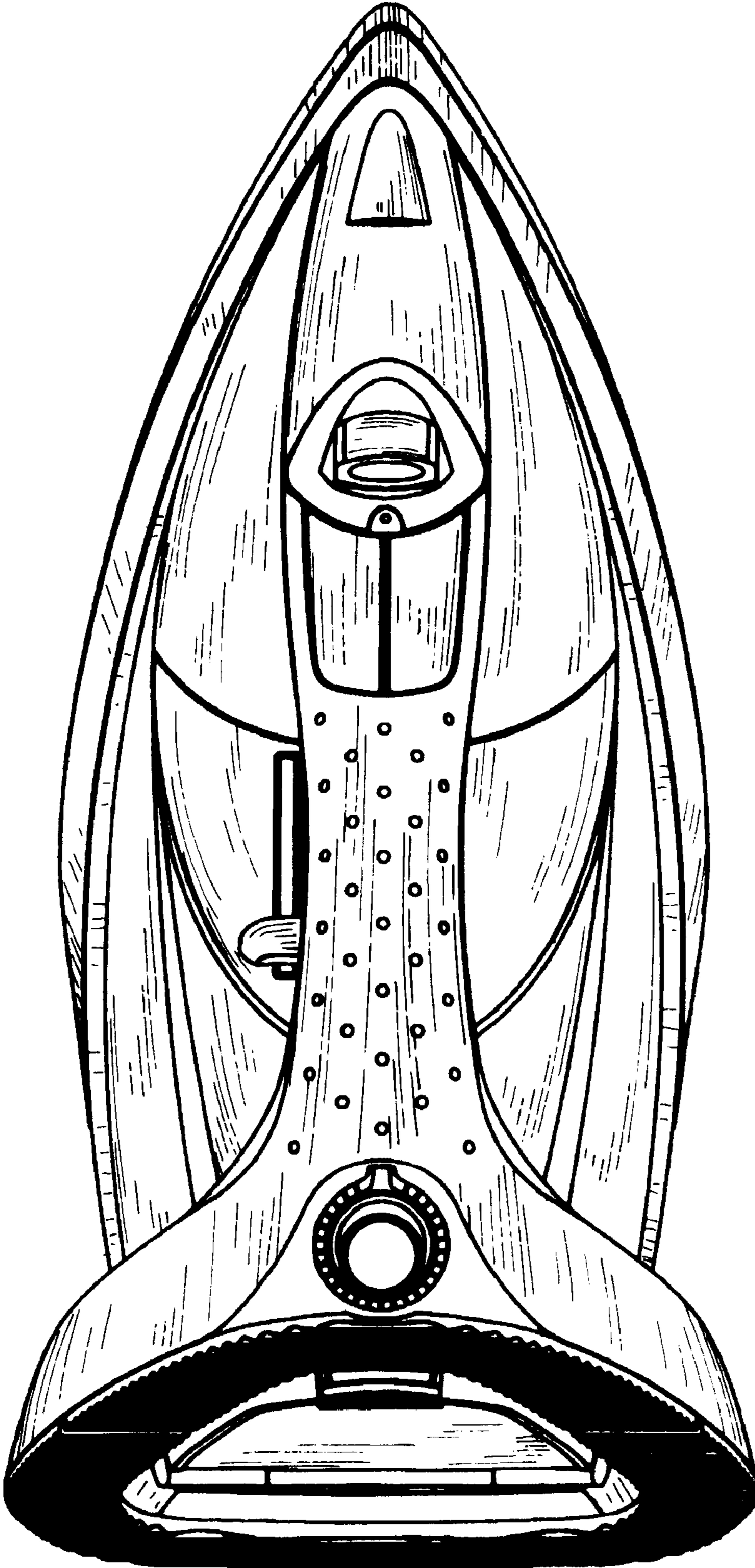

Figure 12

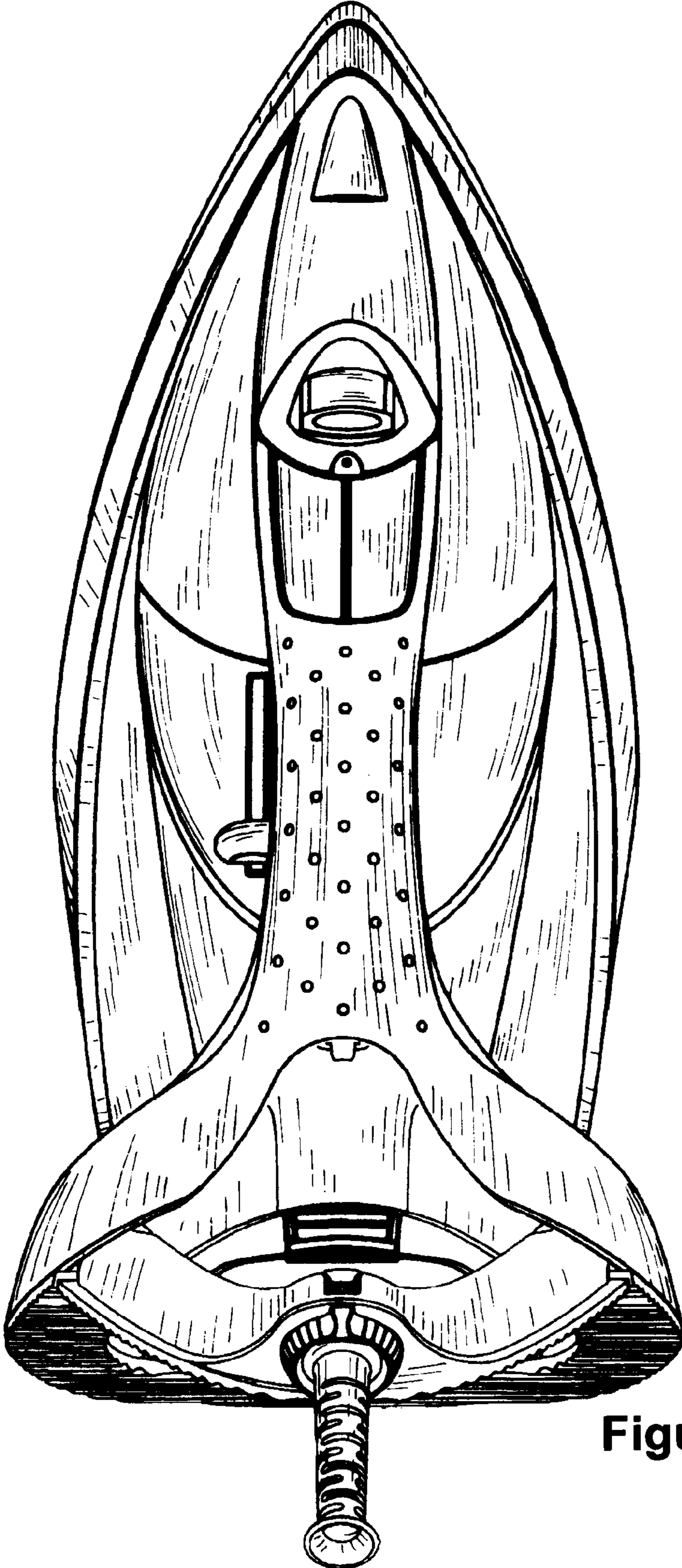

Figure 13

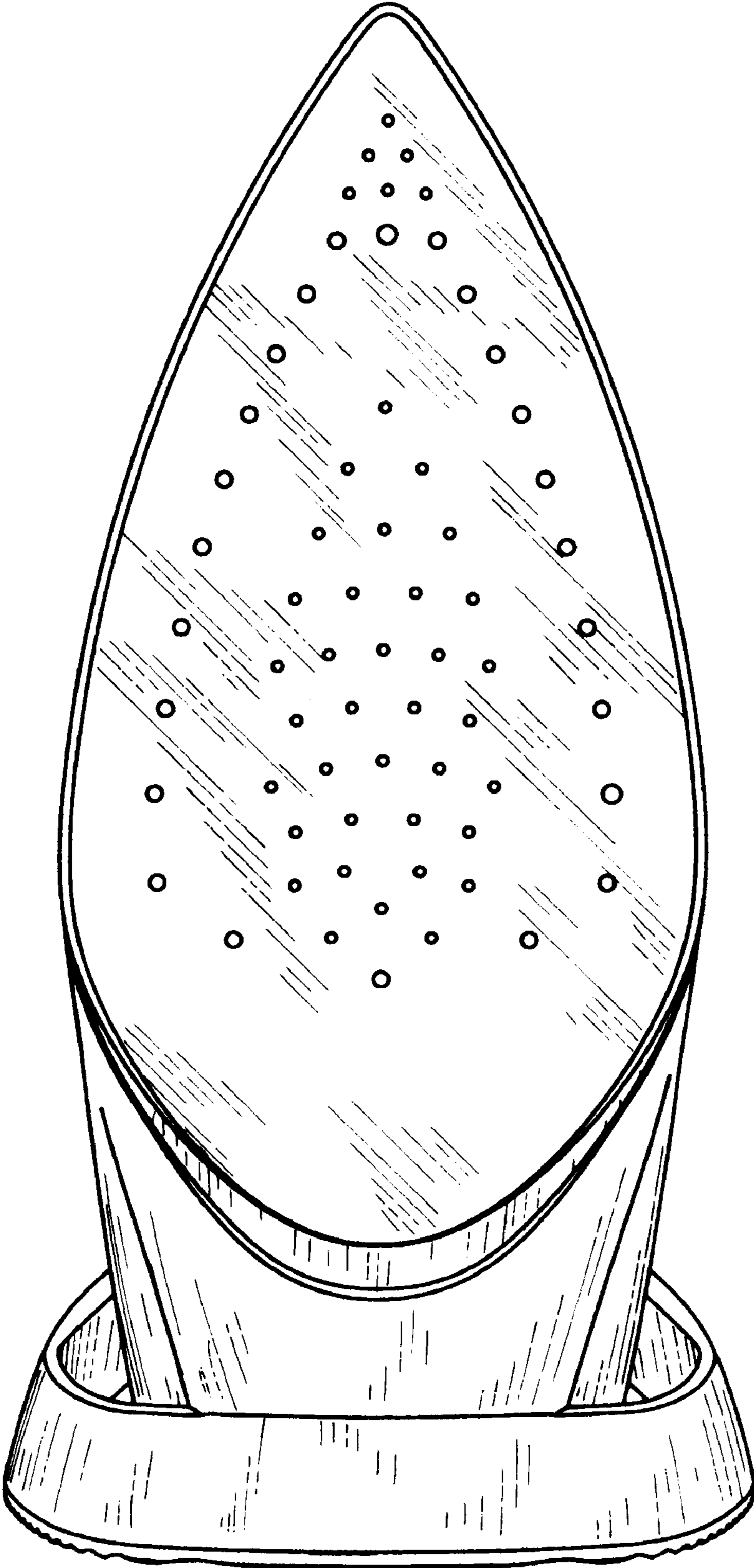

Figure 14

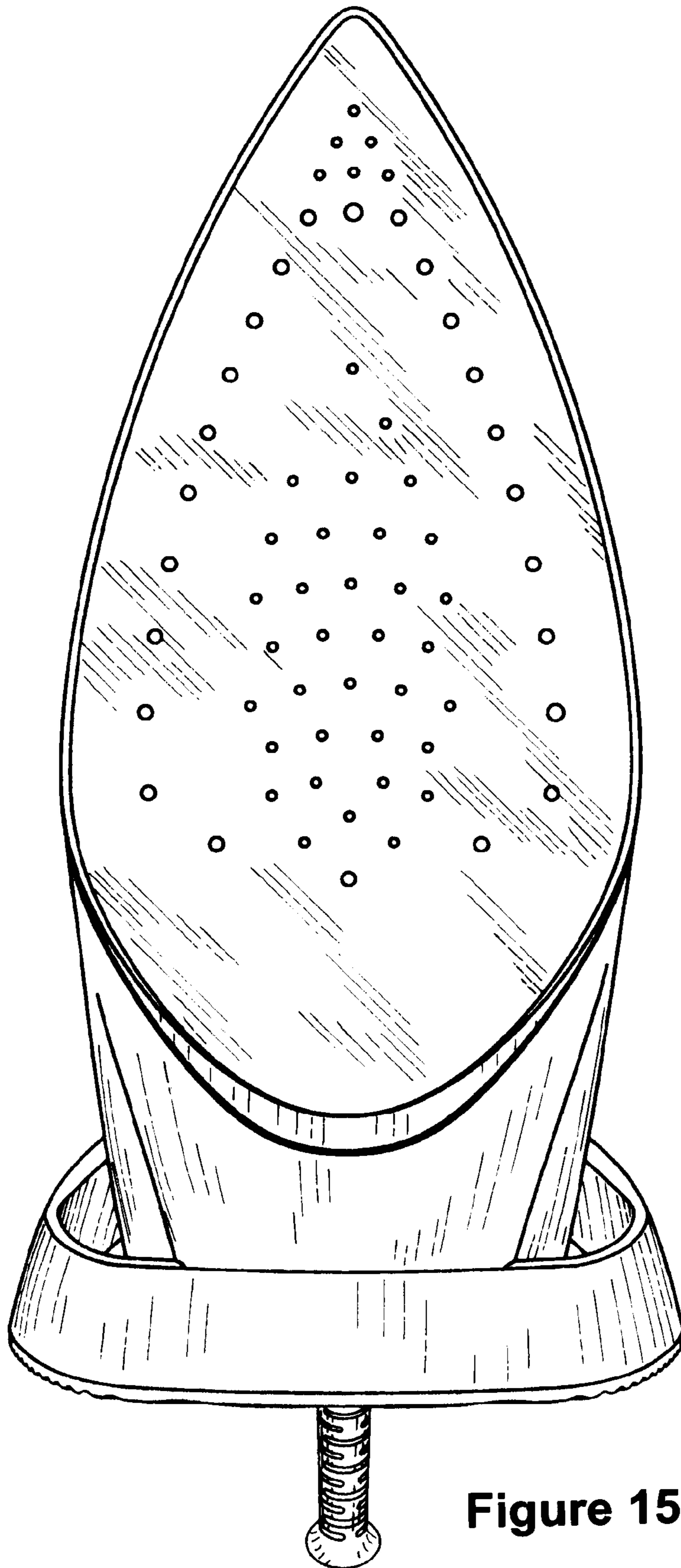

Figure 15