



US00D567429S

(12) **United States Design Patent**
Pickett

(10) **Patent No.:** **US D567,429 S**
(45) **Date of Patent:** **** Apr. 22, 2008**

(54) **CEILING FAN LIGHT FIXTURE**

(76) Inventor: **Mark Pickett**, 1419 E. Palm St.,
Altadena, CA (US) 91001

(**) Term: **14 Years**

(21) Appl. No.: **29/279,487**

(22) Filed: **May 2, 2007**

(51) **LOC (8) Cl.** **26-03**

(52) **U.S. Cl.** **D26/89; D26/59; D26/128**

(58) **Field of Classification Search** D26/59,
D26/72, 85, 88, 89, 128; D23/377, 379,
D23/411; 362/147, 150, 361, 363, 404
See application file for complete search history.

(56) **References Cited**

U.S. PATENT DOCUMENTS

D87,377 S *	7/1932	Andrews	D26/88
D89,273 S *	2/1933	Blau	D26/131
D99,754 S *	5/1936	Ross et al.	D26/88
2,132,784 A *	10/1938	Guth	362/309
D118,742 S *	1/1940	Miller	D26/88
D178,212 S *	7/1956	Schreckengost	D26/89
D226,217 S *	1/1973	Schreckengost	D26/88
D232,050 S *	7/1974	Gore et al.	D26/88
D556,939 S *	12/2007	Gajewski	D26/89

* cited by examiner

Primary Examiner—Clare E Heflin

(74) *Attorney, Agent, or Firm*—Parsons & Goltry; Michael
W. Goltry; Robert A. Parsons

(57) **CLAIM**

The ornamental design for a ceiling fan light fixture, as
shown and described.

DESCRIPTION

FIG. 1 is a top perspective view of a ceiling fan light fixture
showing my new design;

FIG. 2 is a bottom perspective view thereof;

FIG. 3 is front elevational view thereof, the rear elevational
view thereof, the left side elevational view thereof, and the
right side elevational view thereof being substantially the
same thereof;

FIG. 4 is a top plan view thereof; and,

FIG. 5 is a bottom plan view thereof.

The broken line in FIGS. 1 and 4 showing the top opening
into the ceiling fan light fixture is included for the purpose
of illustrating environmental structure and forms no part of
the claimed design.

1 Claim, 5 Drawing Sheets

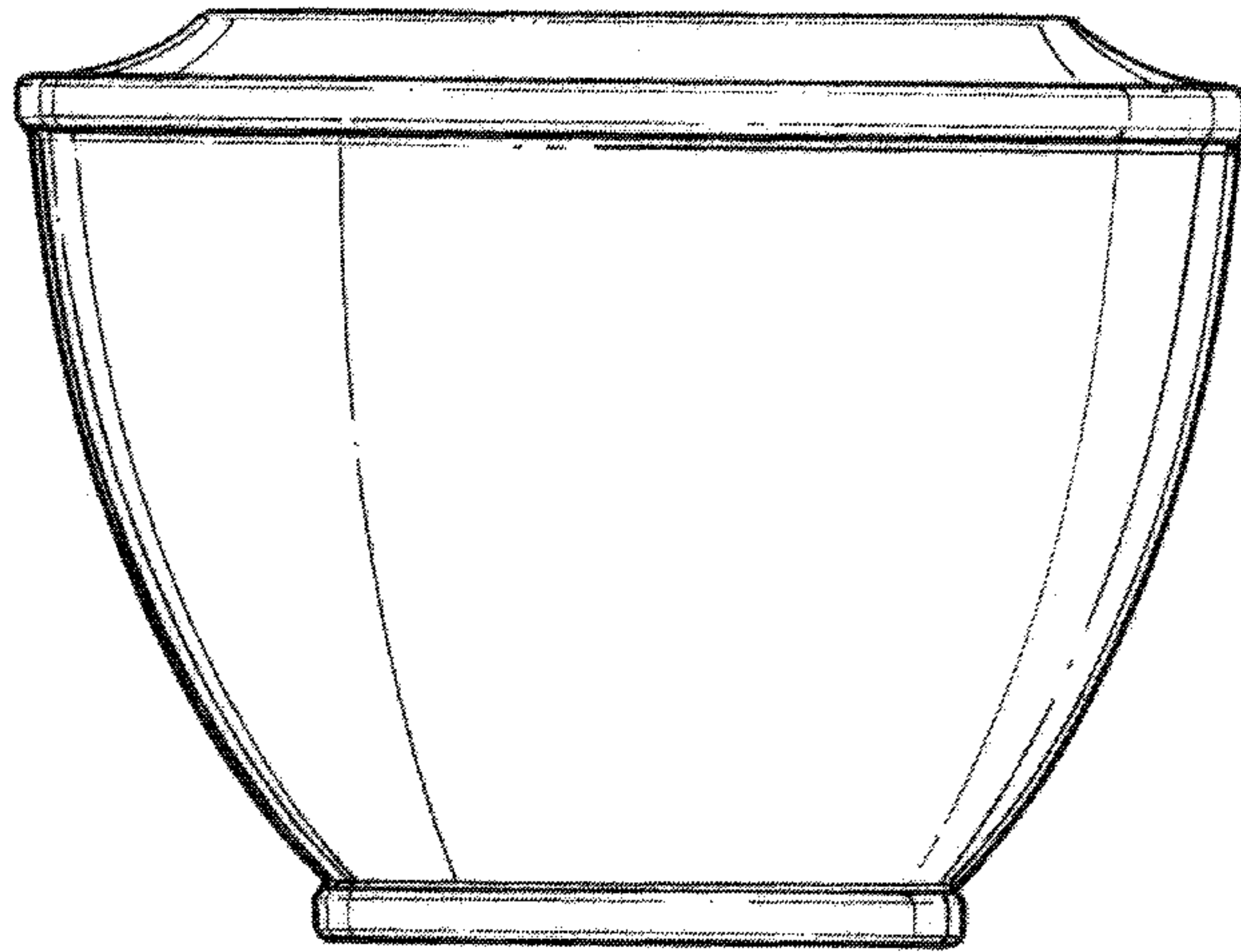
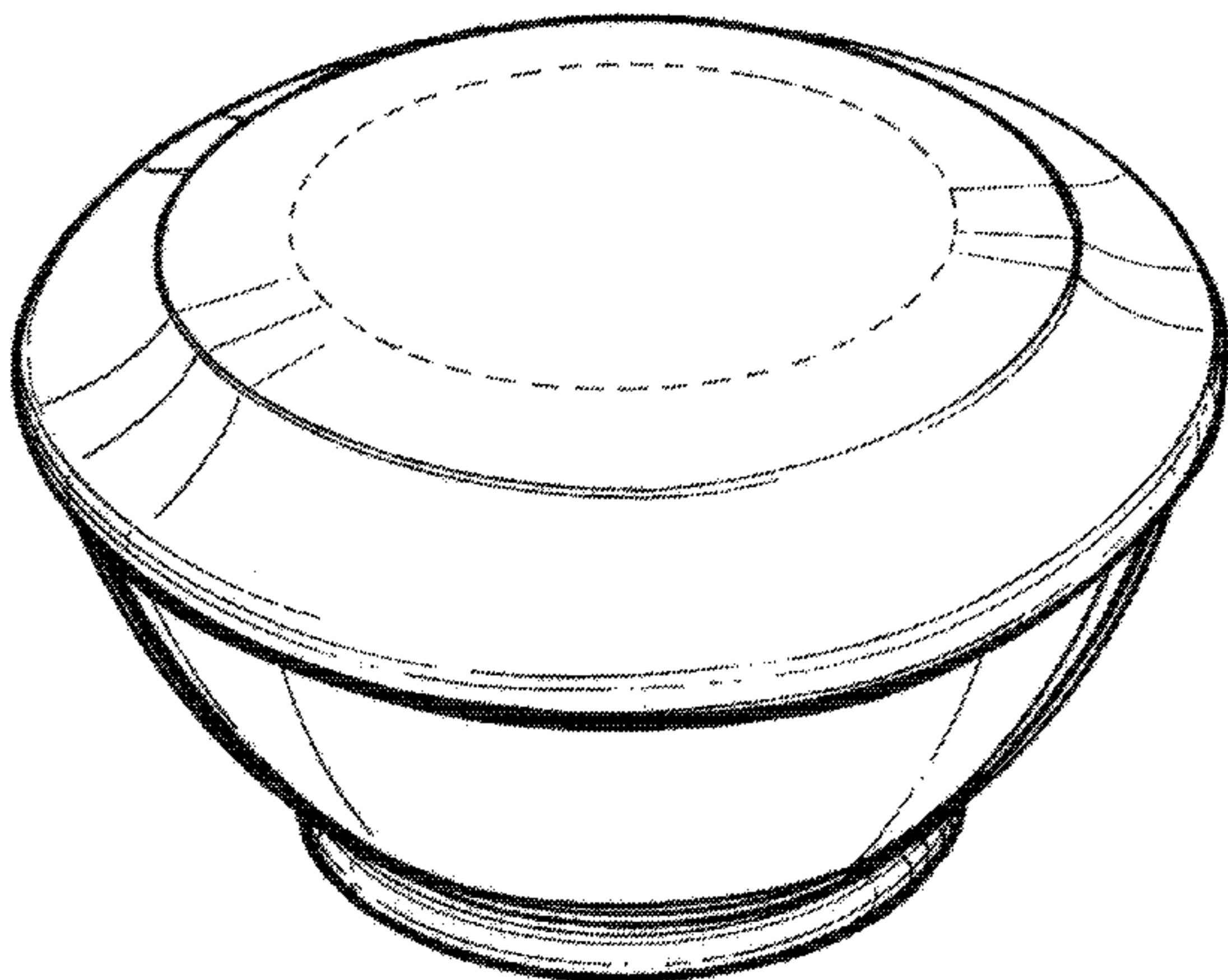
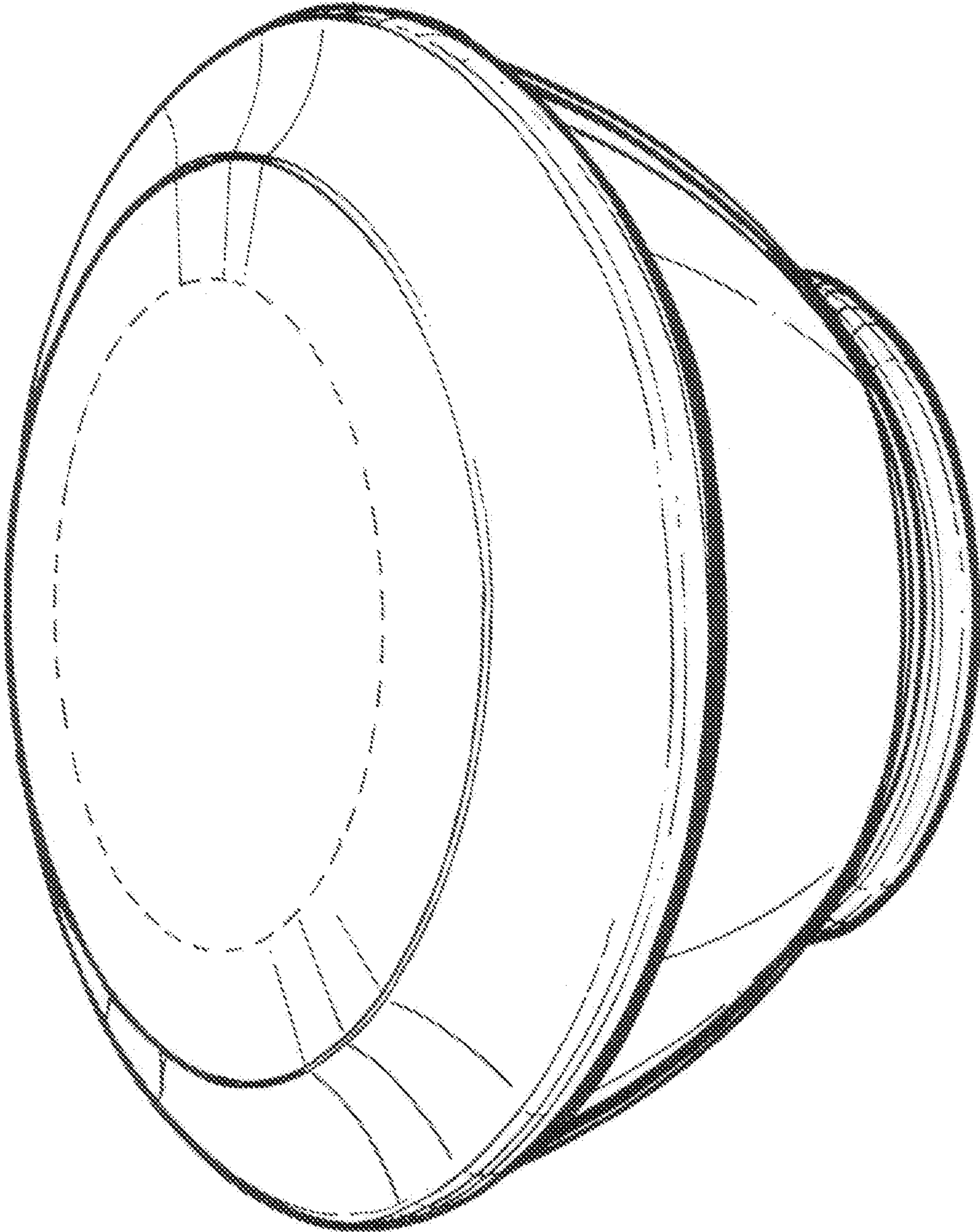

FIG. 1



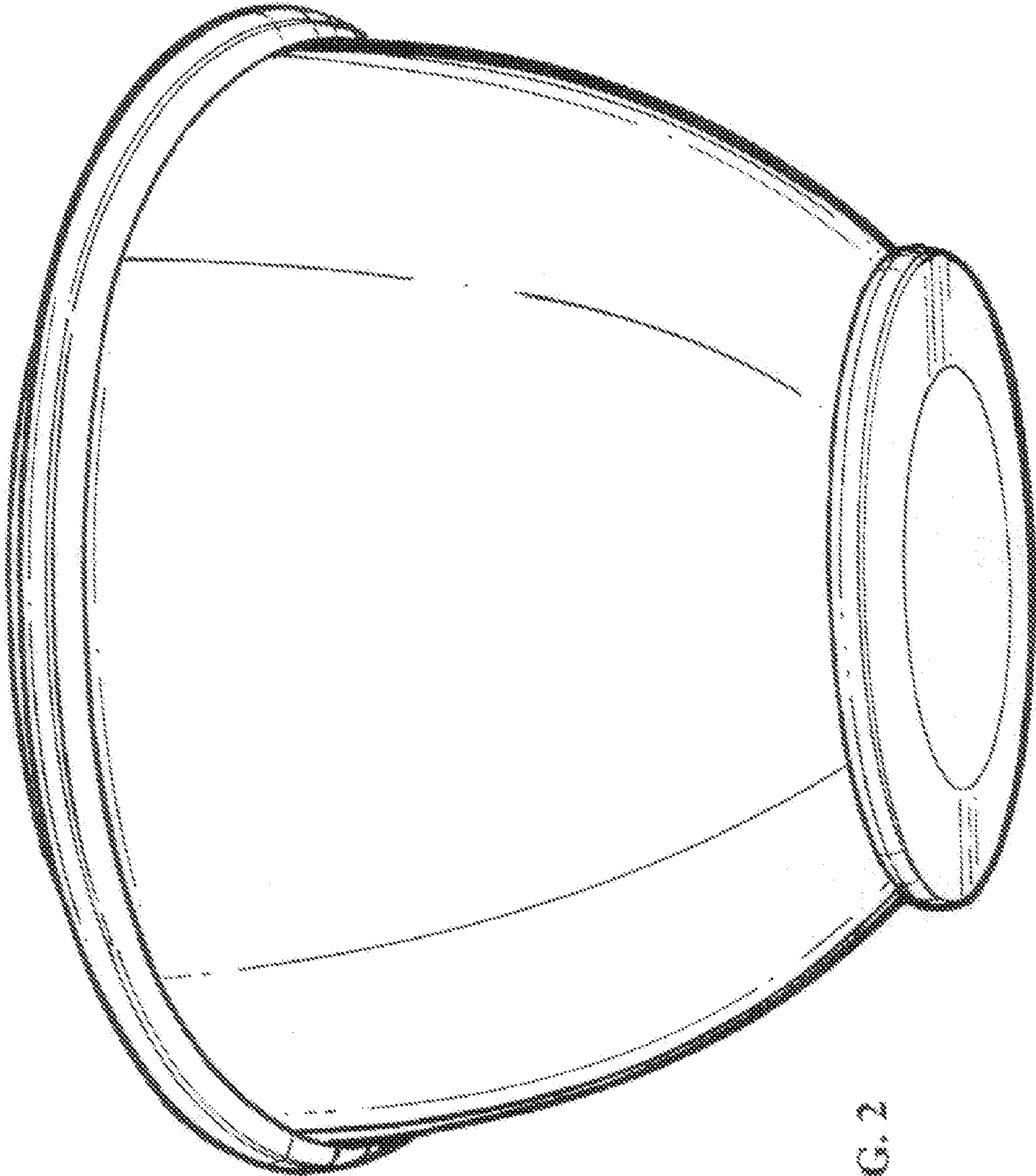

FIG. 2

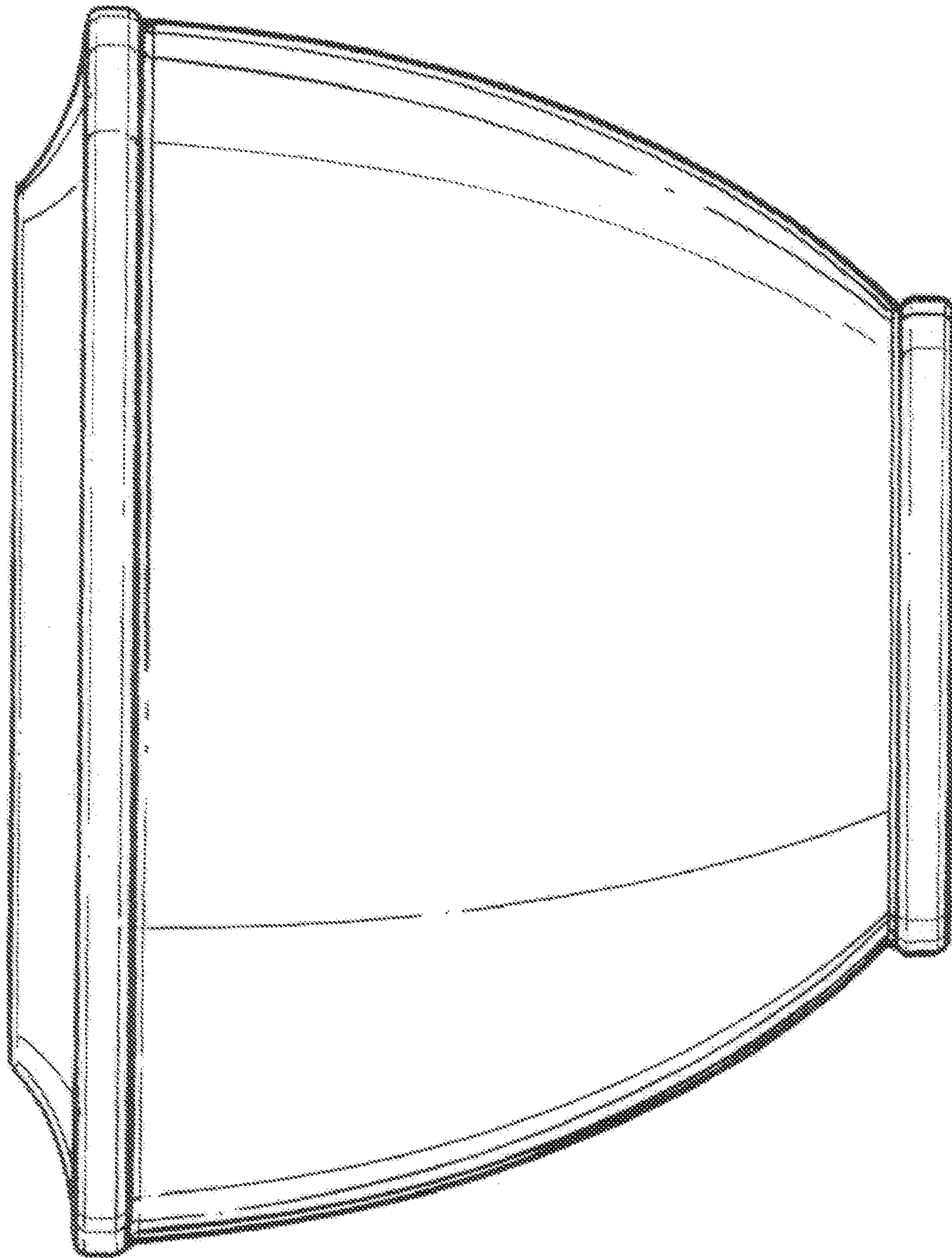

FIG. 3

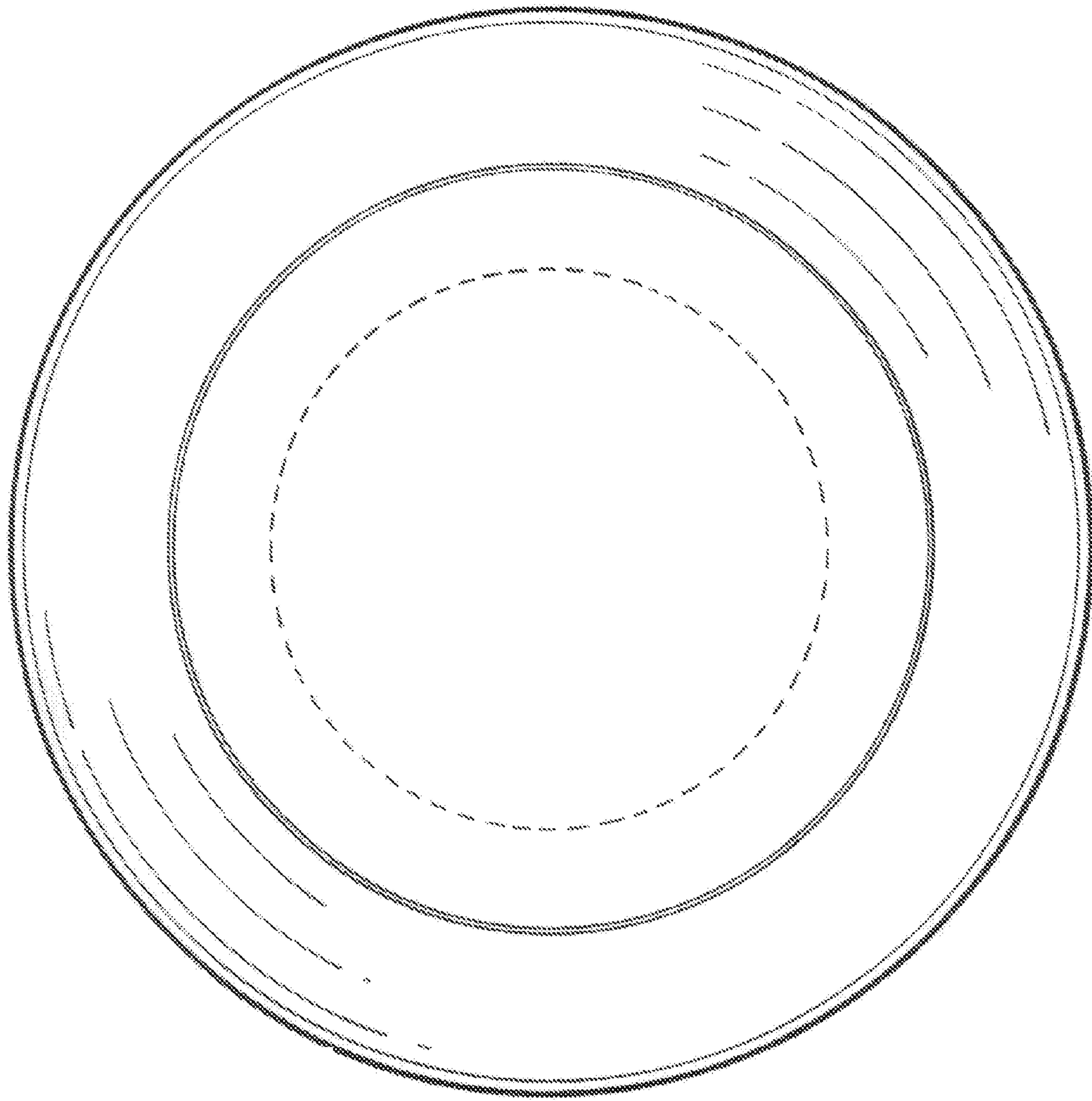

FIG. 4

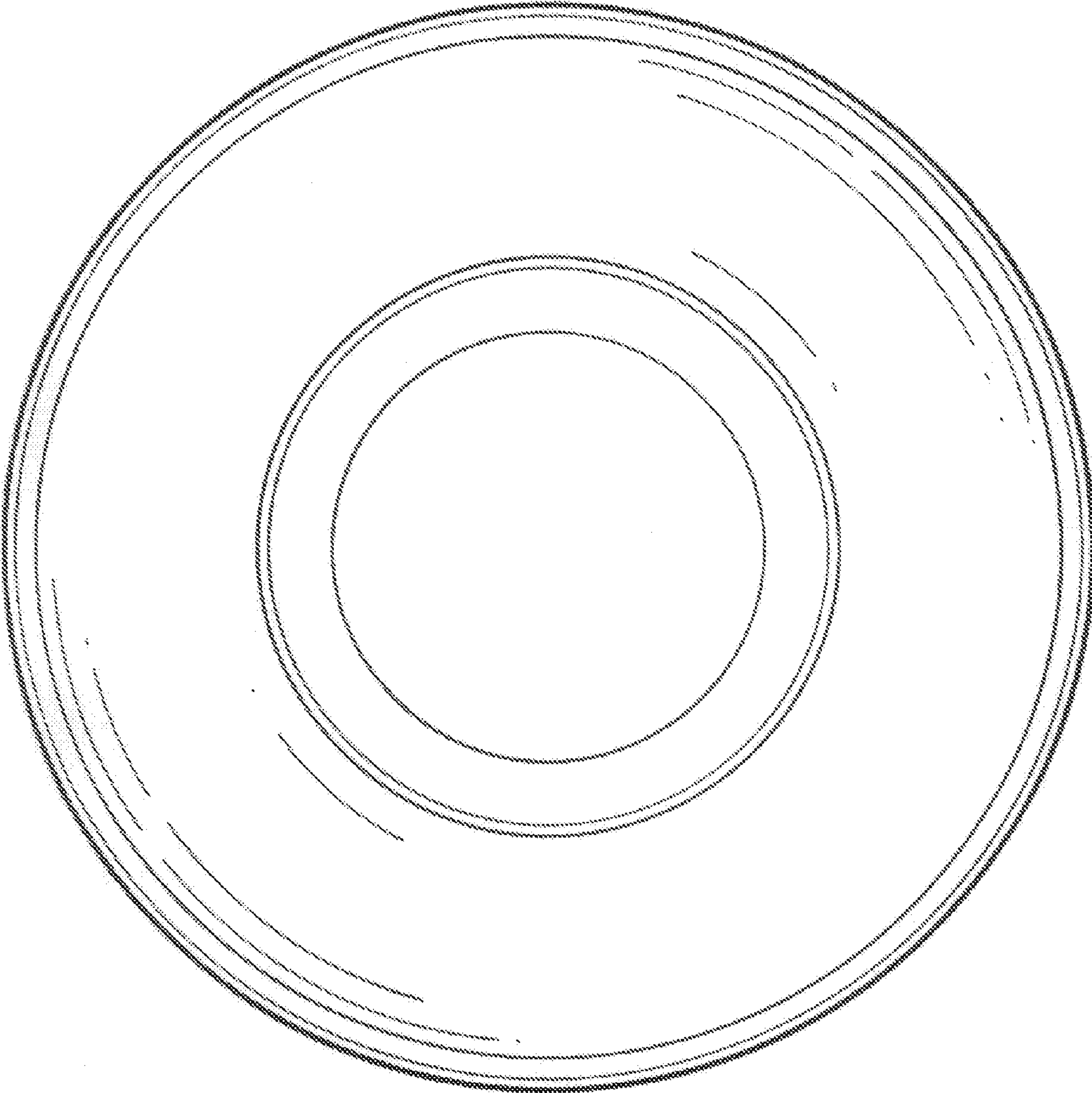

FIG. 5