



US00D567255S

(12) **United States Design Patent**
Miyawaki

(10) **Patent No.:** **US D567,255 S**
(45) **Date of Patent:** **** Apr. 22, 2008**

(54) **DIGITAL AUDIO PLAYER**

(75) Inventor: **Masayuki Miyawaki**, Chigasaki (JP)

(73) Assignee: **Clarion Co., Ltd.**, Tokyo (JP)

(**) Term: **14 Years**

(21) Appl. No.: **29/287,588**

(22) Filed: **Aug. 27, 2007**

(30) **Foreign Application Priority Data**

Jul. 3, 2007 (JP) 2007-017973

(51) **LOC (8) Cl.** **14-03**

(52) **U.S. Cl.** **D14/496**

(58) **Field of Classification Search** D14/496,
D14/401, 435, 474, 483, 217, 137, 138, 160,
D14/168; 345/156, 169, 173-179, 905; 715/727-729,
715/864; 455/11.1, 7, 73, 344-347, 93, 95;
370/342-344; 369/1, 2, 6, 12; 463/43-47;
273/148 B

See application file for complete search history.

(56) **References Cited**

U.S. PATENT DOCUMENTS

D491,902 S * 6/2004 Chen D14/126
D496,944 S * 10/2004 Huang D14/496
6,869,320 B2 * 3/2005 Haas et al. 439/701
6,934,568 B2 * 8/2005 Charlier et al. 455/575.3
D515,551 S * 2/2006 Watanabe D14/168
7,028,127 B2 * 4/2006 Kang et al. 710/303
7,054,152 B2 * 5/2006 Francke et al. 361/685
D545,810 S * 7/2007 Hussaini et al. D14/168
D554,149 S * 10/2007 Kim D14/496

FOREIGN PATENT DOCUMENTS

JP S D1075380 6/2000
JP S D1099489 2/2001
JP S D1116273 7/2001
JP S D1160841 12/2002
JP S D1171428 4/2003
JP S D1173565 5/2003

JP S D1186049 9/2003
JP S D1186115 9/2003
JP S D1200871 4/2004
JP S D1210381 6/2004
JP S D1237673 4/2005
JP S D1244146 6/2005
JP S D1280266 9/2006
JP S D1281560 9/2006
JP 2006-034786 12/2006
JP S D1290599 1/2007
JP S D1294852 2/2007

* cited by examiner

Primary Examiner—Prabhakar Deshmukh

(74) *Attorney, Agent, or Firm*—Oliff & Berridge, PLC

(57) **CLAIM**

The ornamental design for a digital audio player, as shown and described.

DESCRIPTION

FIG. 1 is a perspective view of the digital audio player showing a display in an upright position;

FIG. 2 is a front view thereof;

FIG. 3 is a rear view thereof;

FIG. 4 is a left-side view thereof;

FIG. 5 is a right-side view thereof;

FIG. 6 is a top view thereof;

FIG. 7 is a bottom view thereof;

FIG. 8 is a perspective view of the digital audio player showing the display in a closed position;

FIG. 9 is a front view thereof;

FIG. 10 is a rear view thereof;

FIG. 11 is a left-side view thereof;

FIG. 12 is a right-side view thereof;

FIG. 13 is a top view thereof; and,

FIG. 14 is a bottom view thereof.

1 Claim, 12 Drawing Sheets

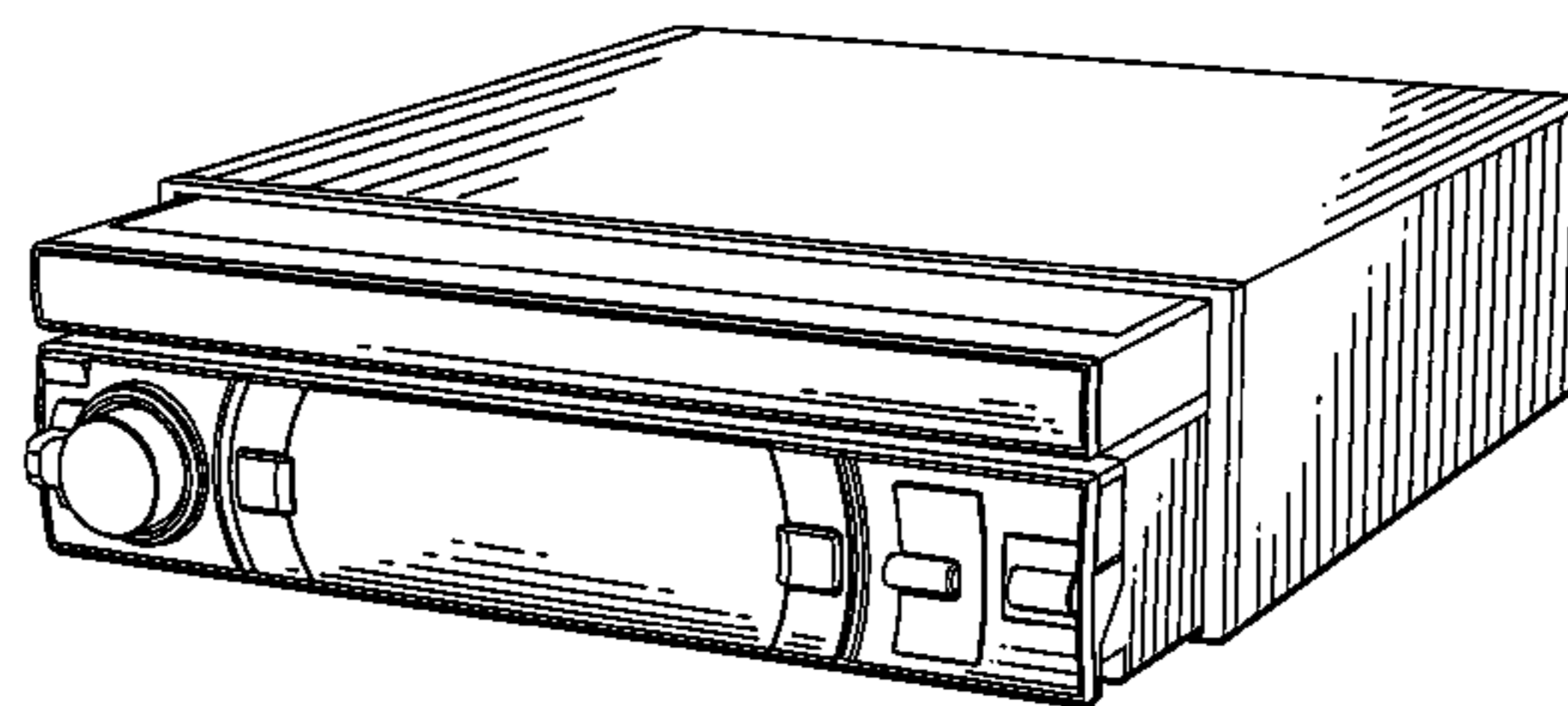
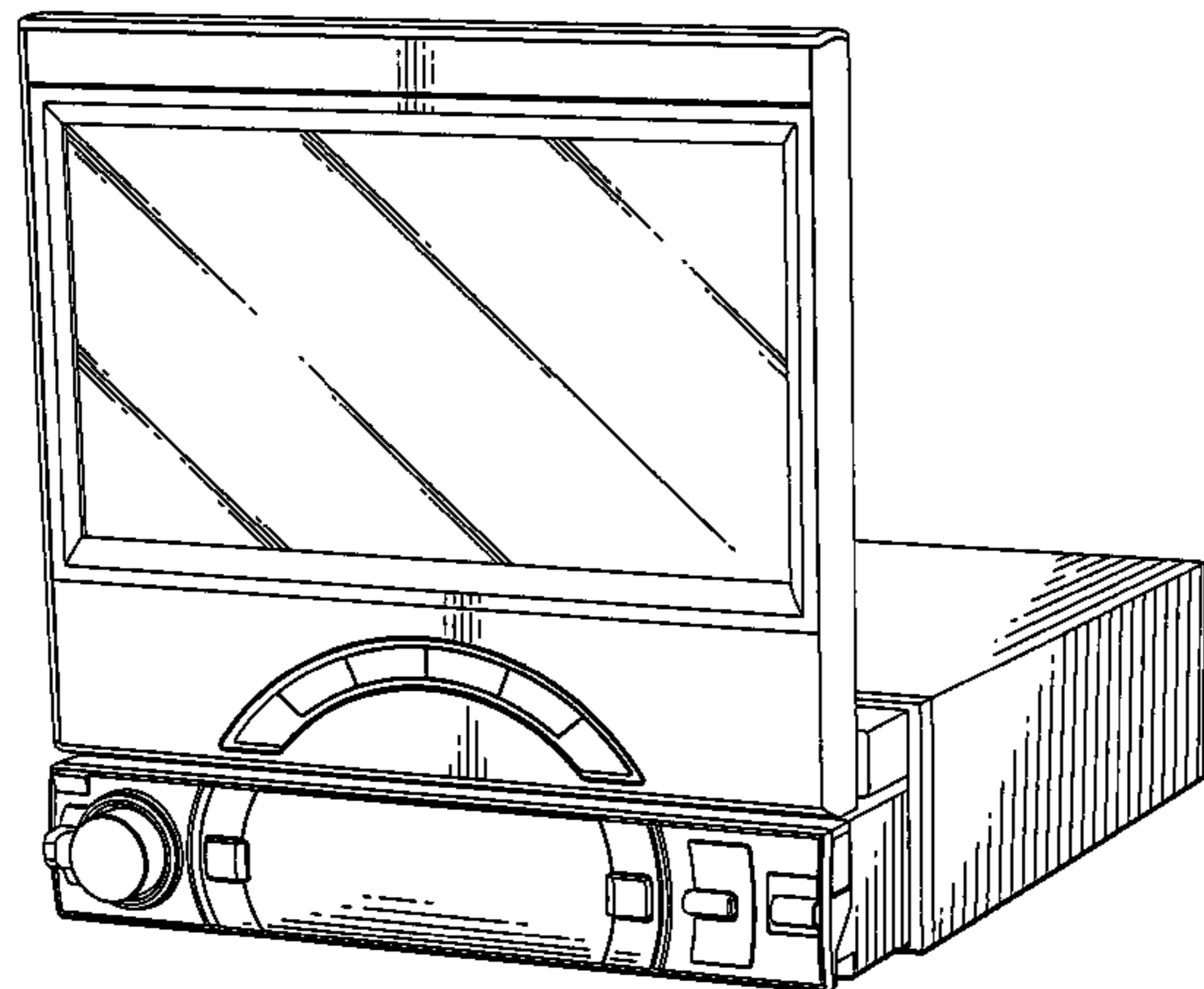

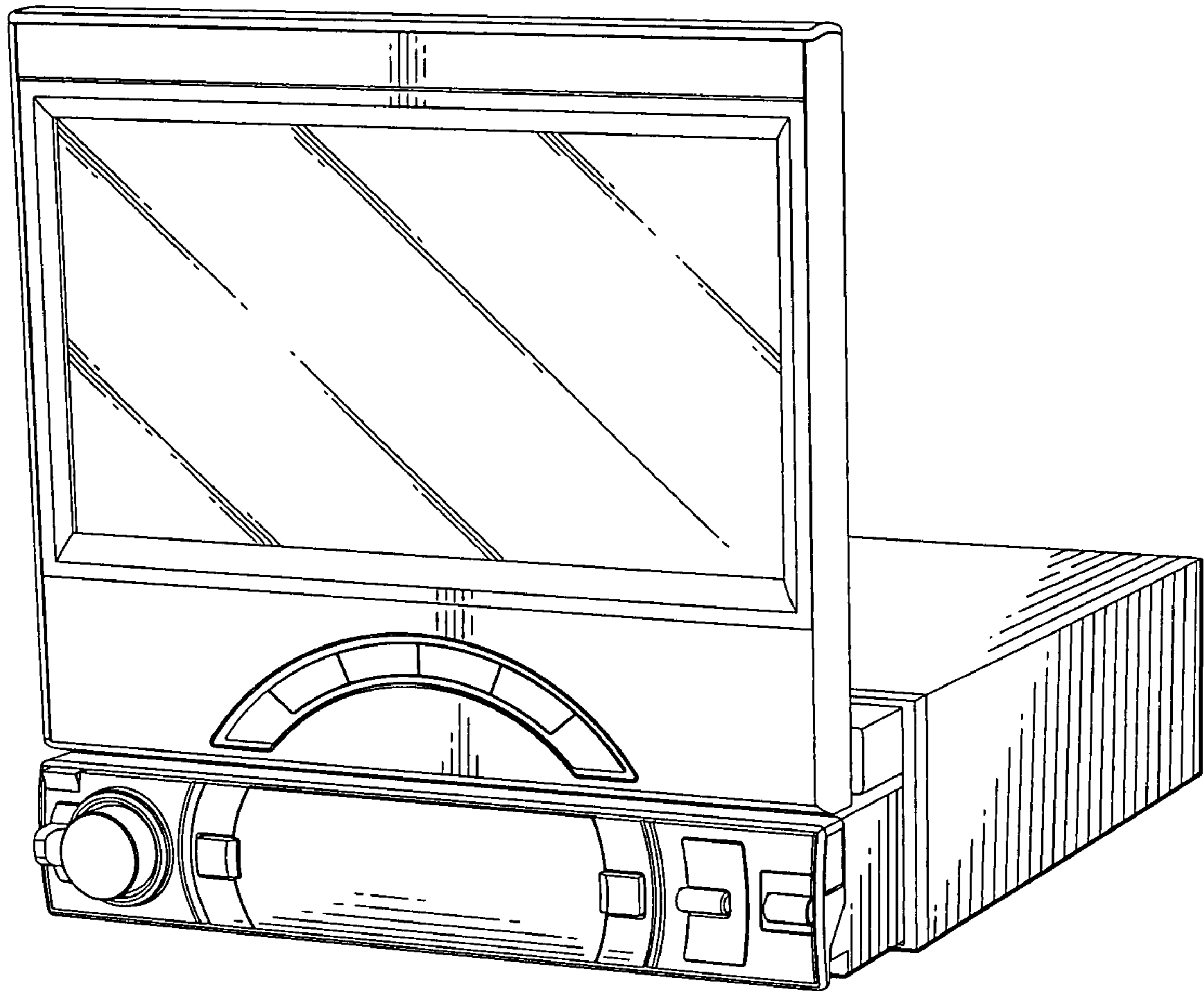

FIG. 1

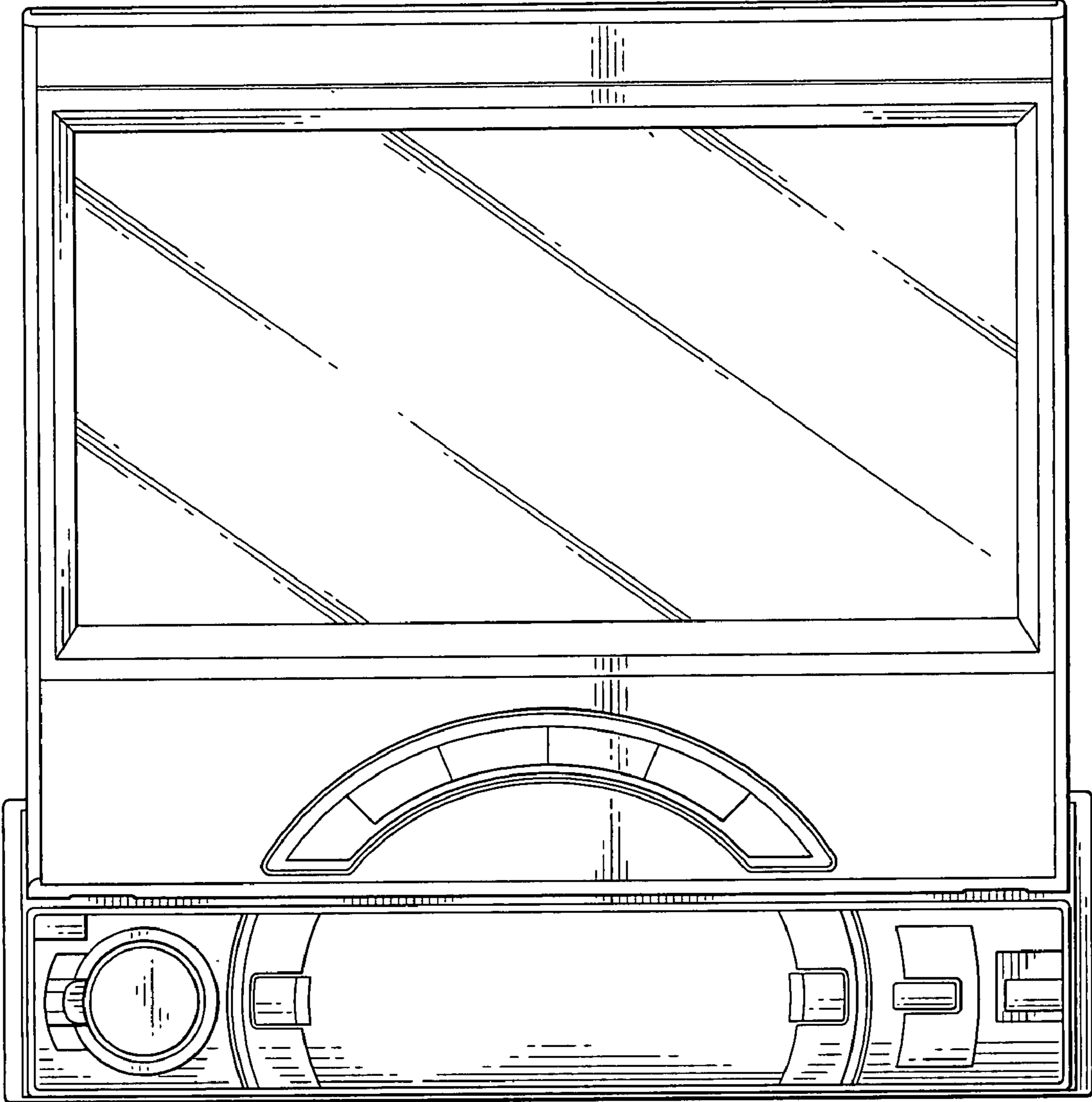

FIG. 2

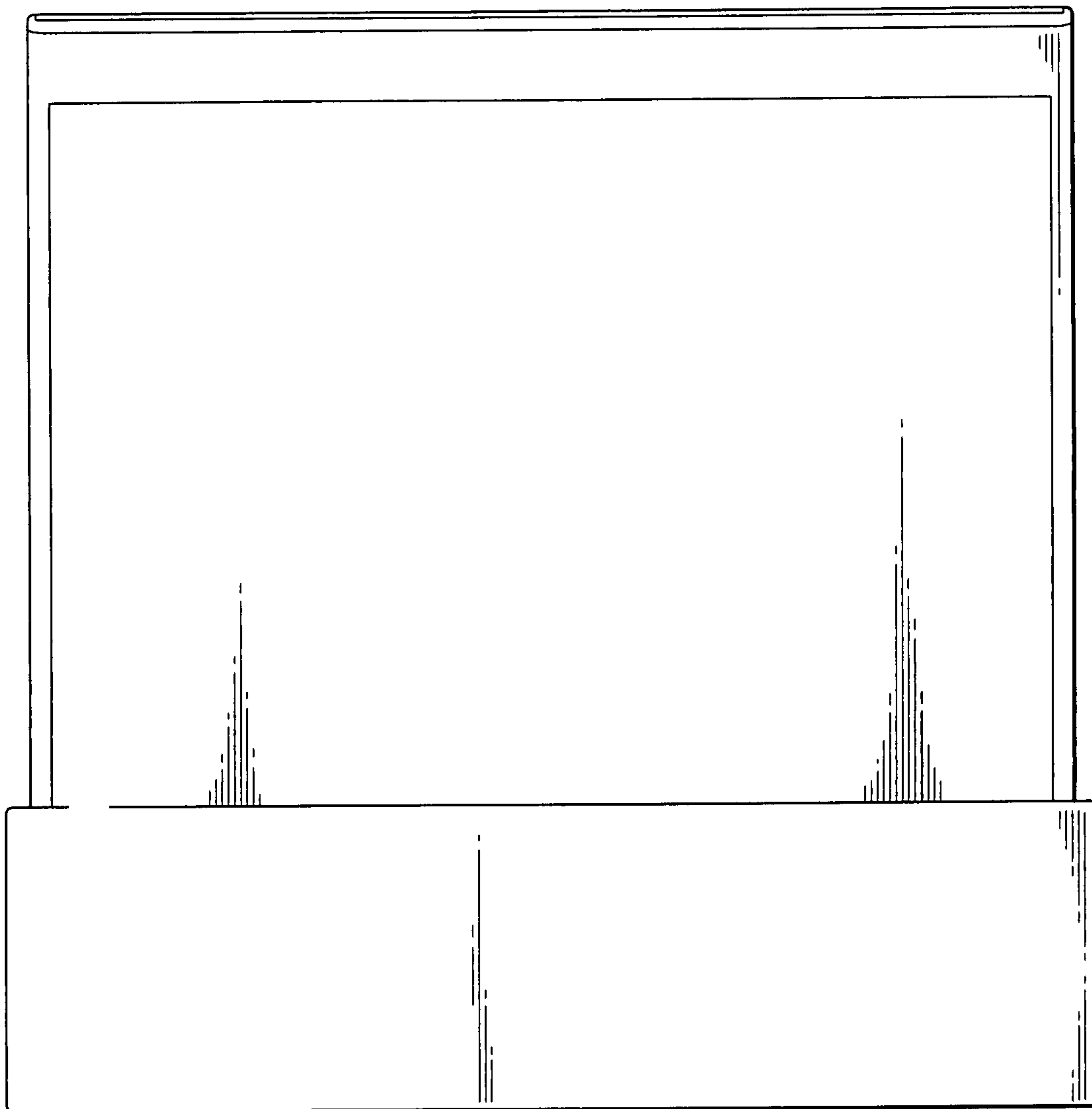

FIG. 3

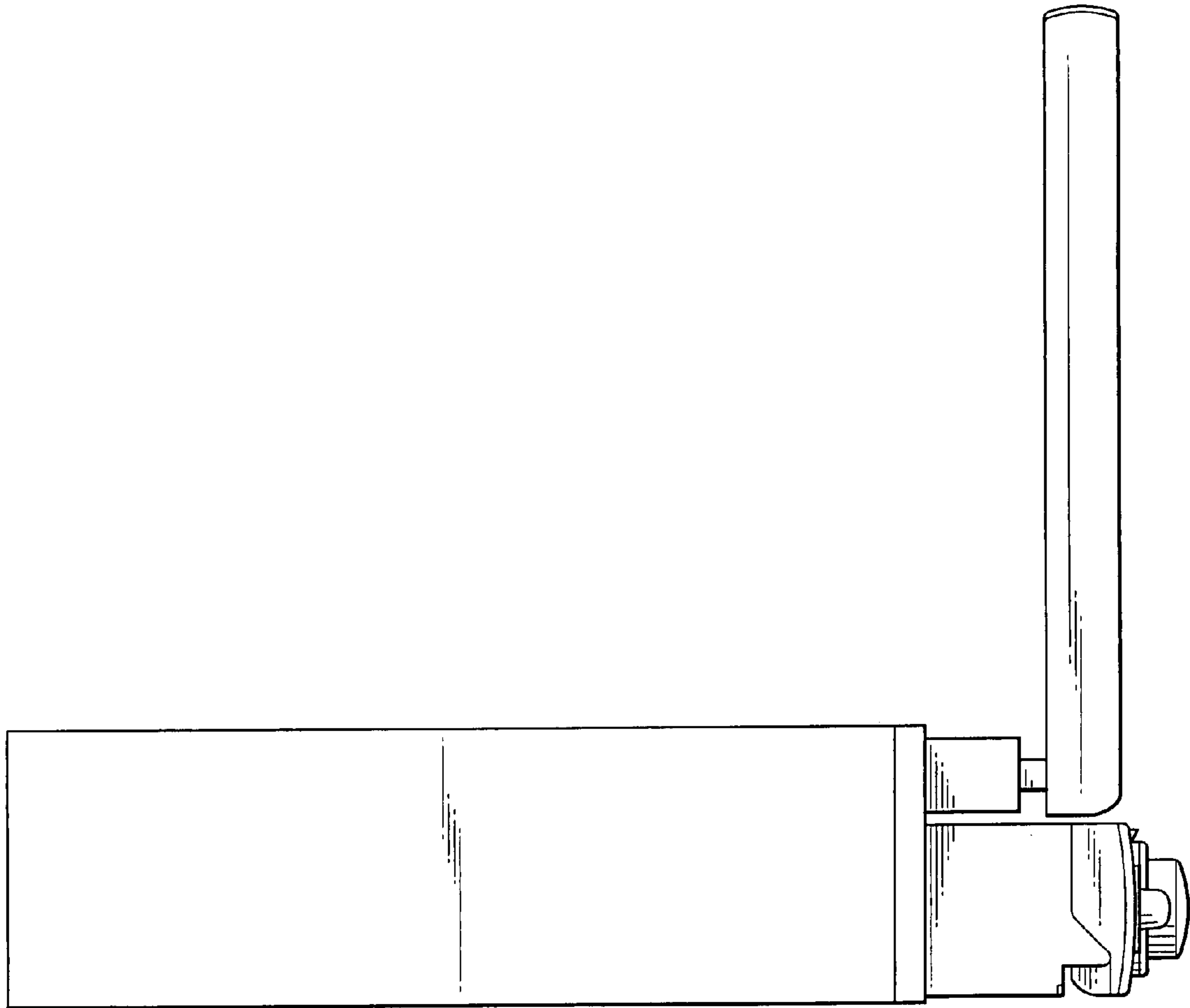

FIG. 4

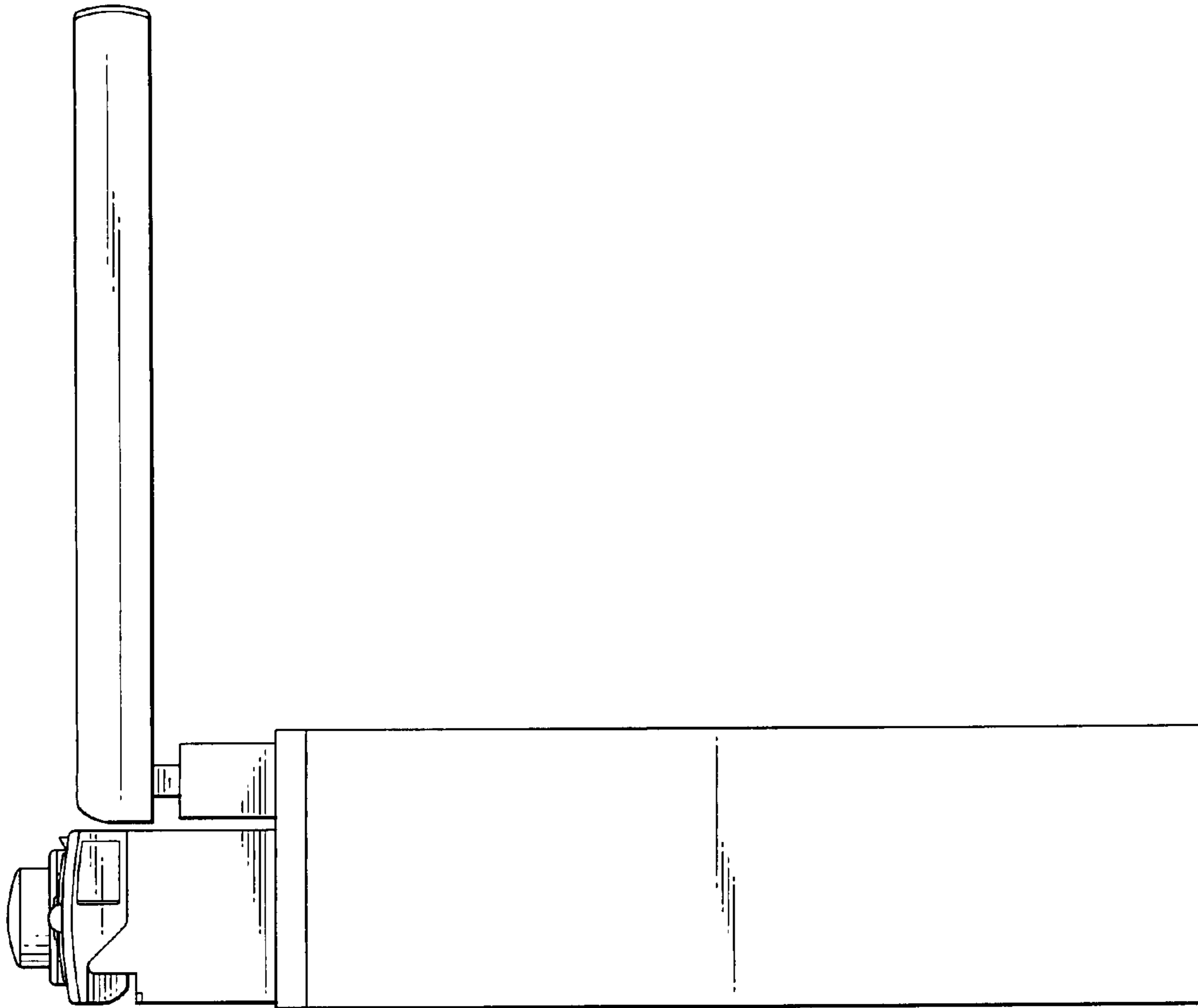

FIG. 5

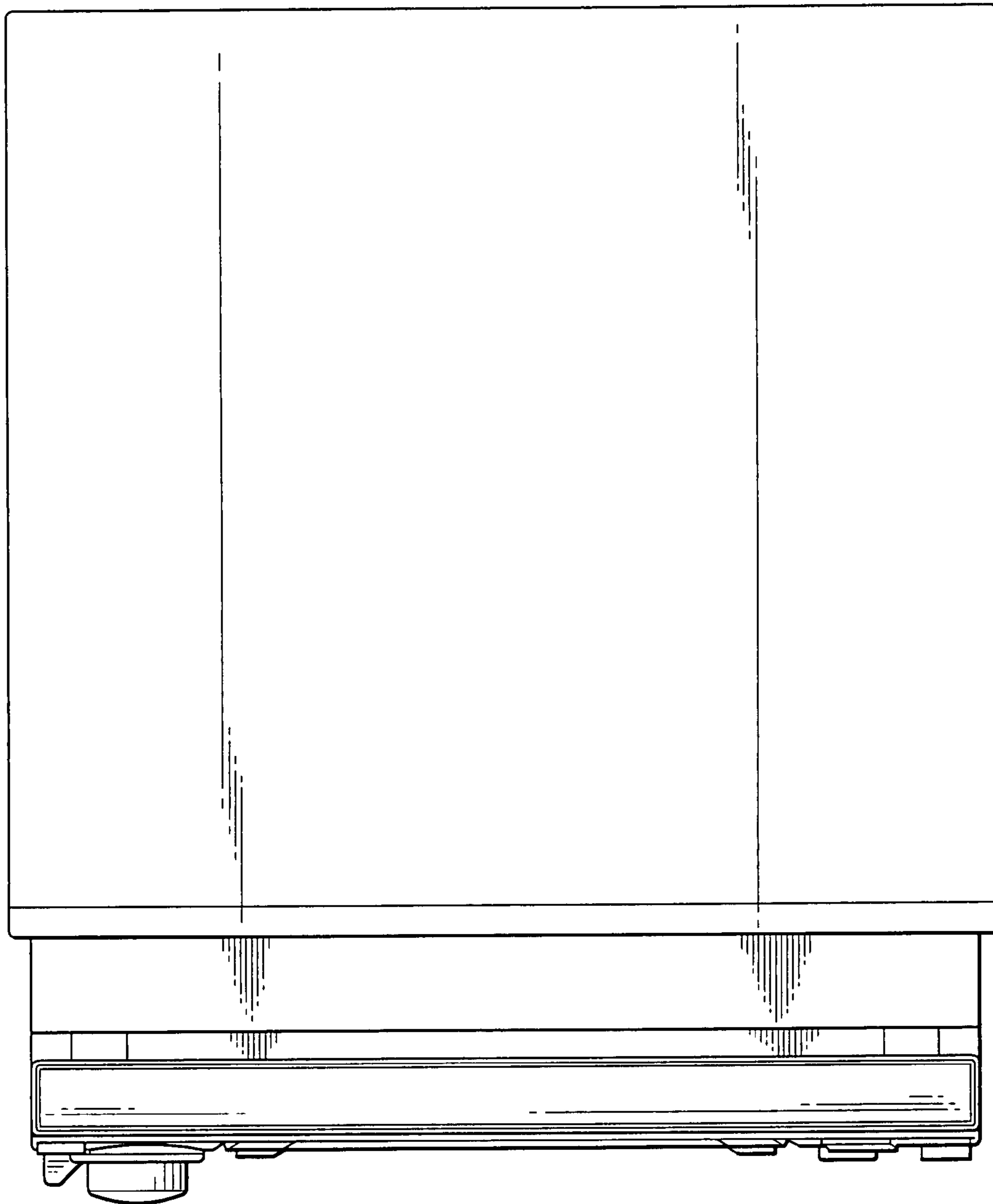

FIG. 6

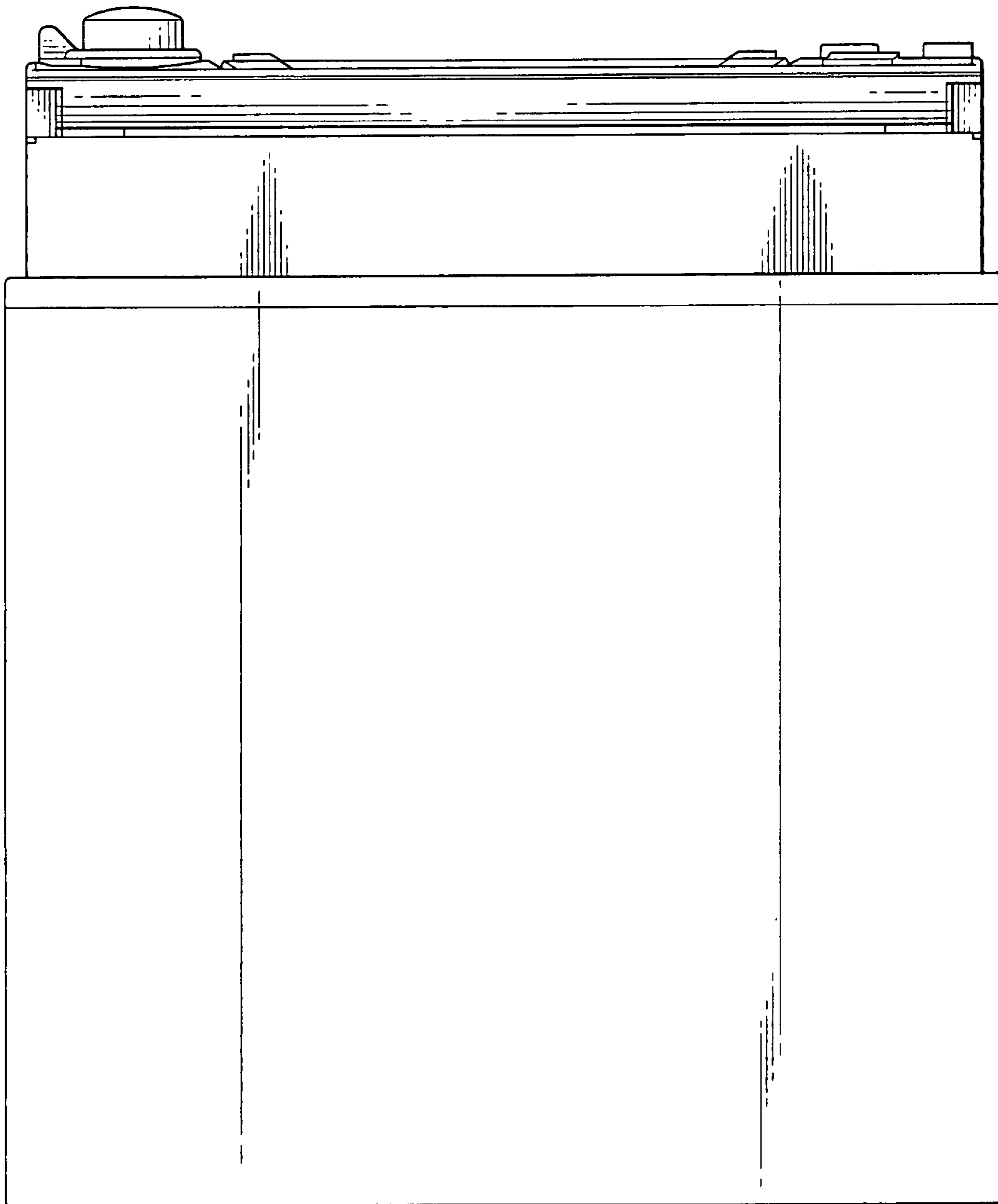

FIG. 7

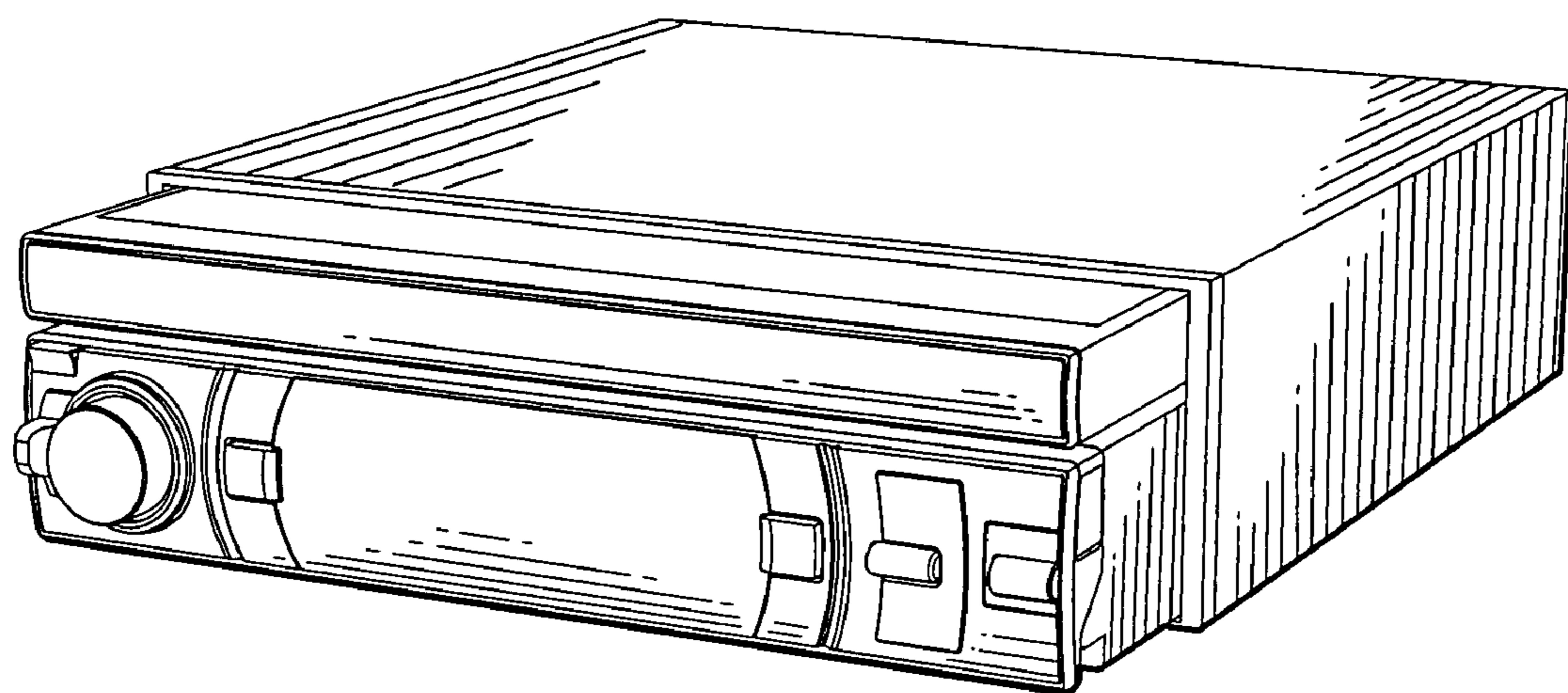

FIG. 8

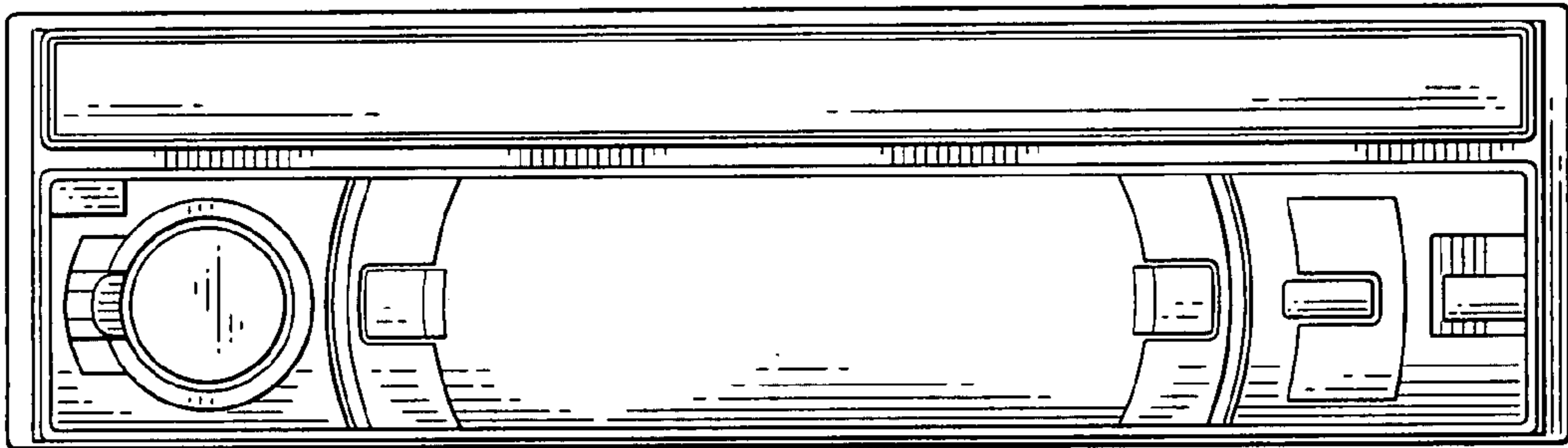

FIG. 9

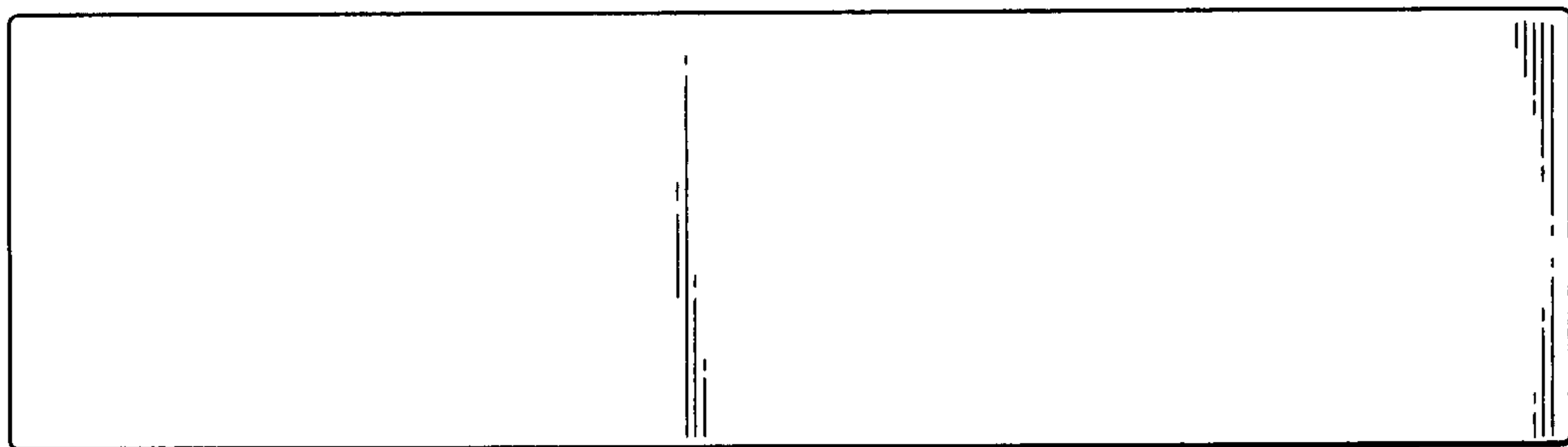

FIG. 10

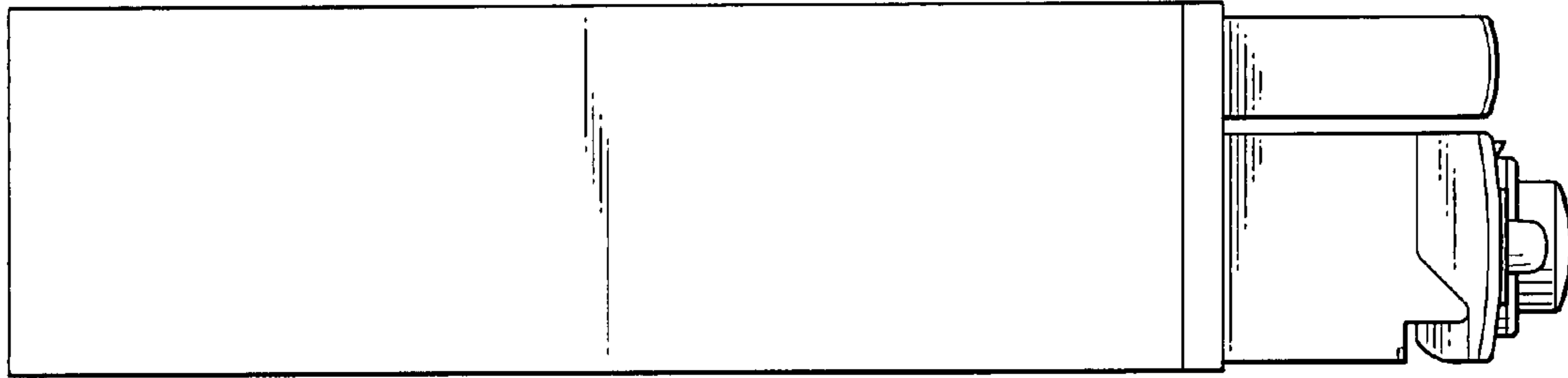

FIG. 11

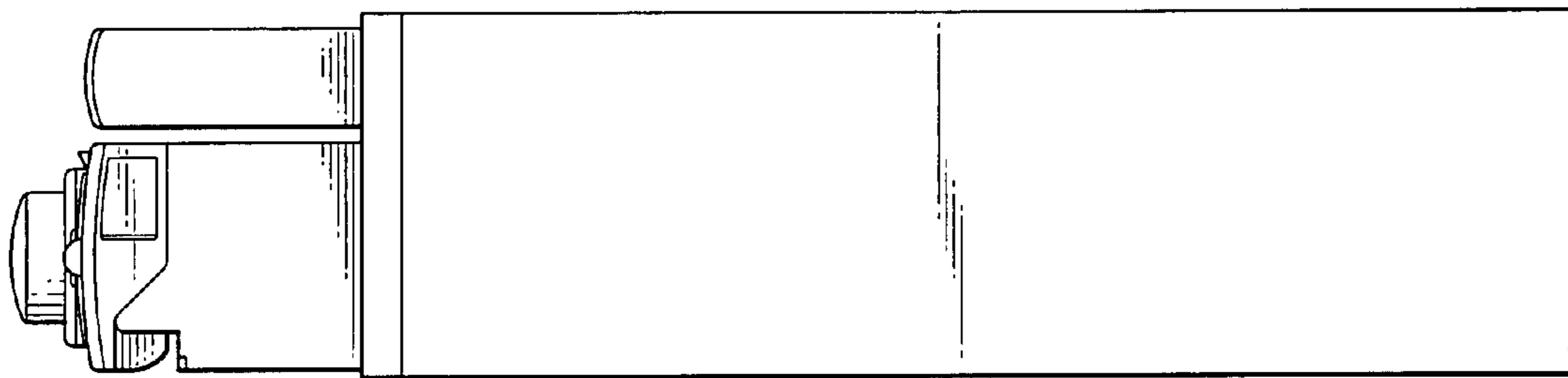

FIG. 12

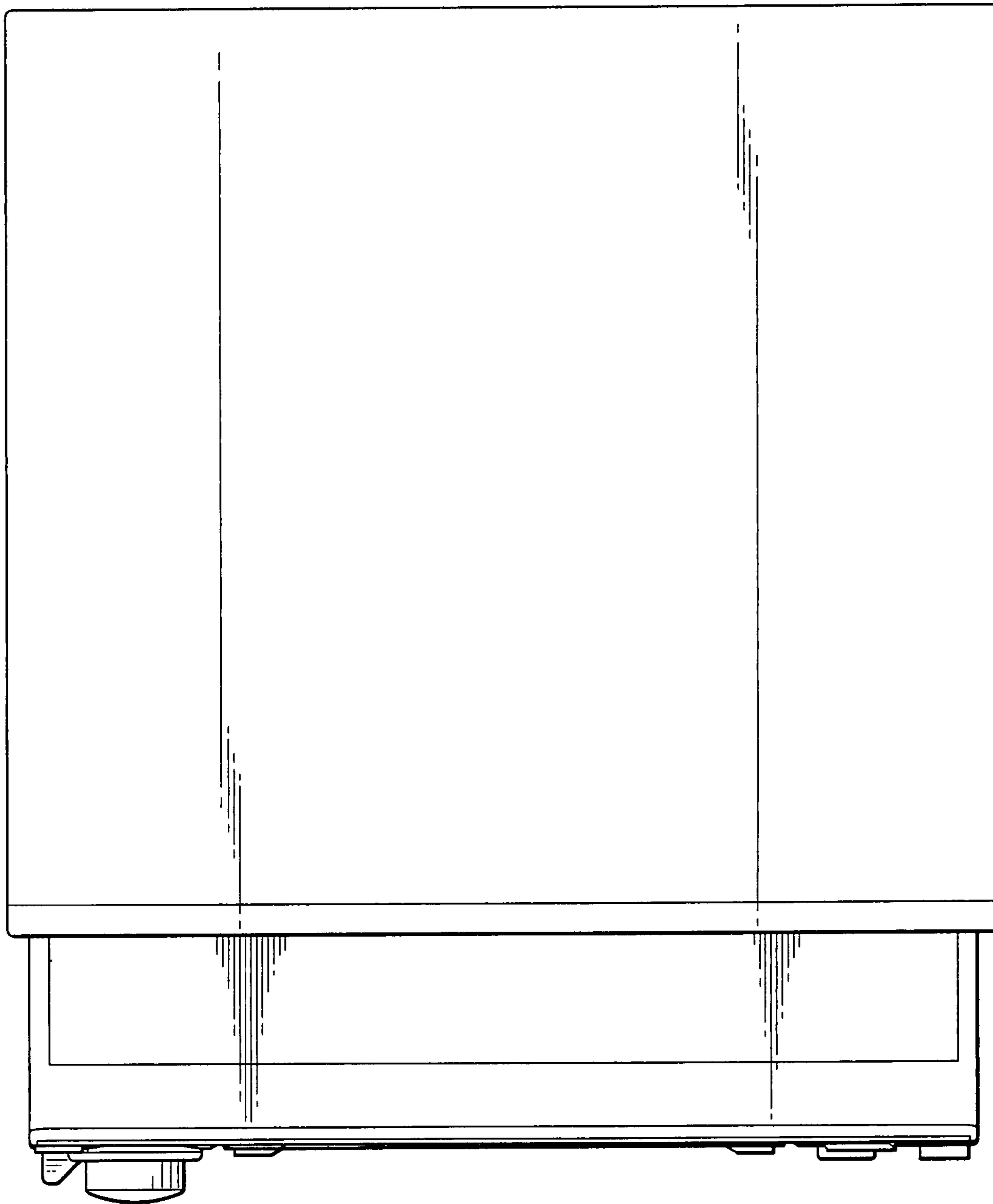

FIG. 13

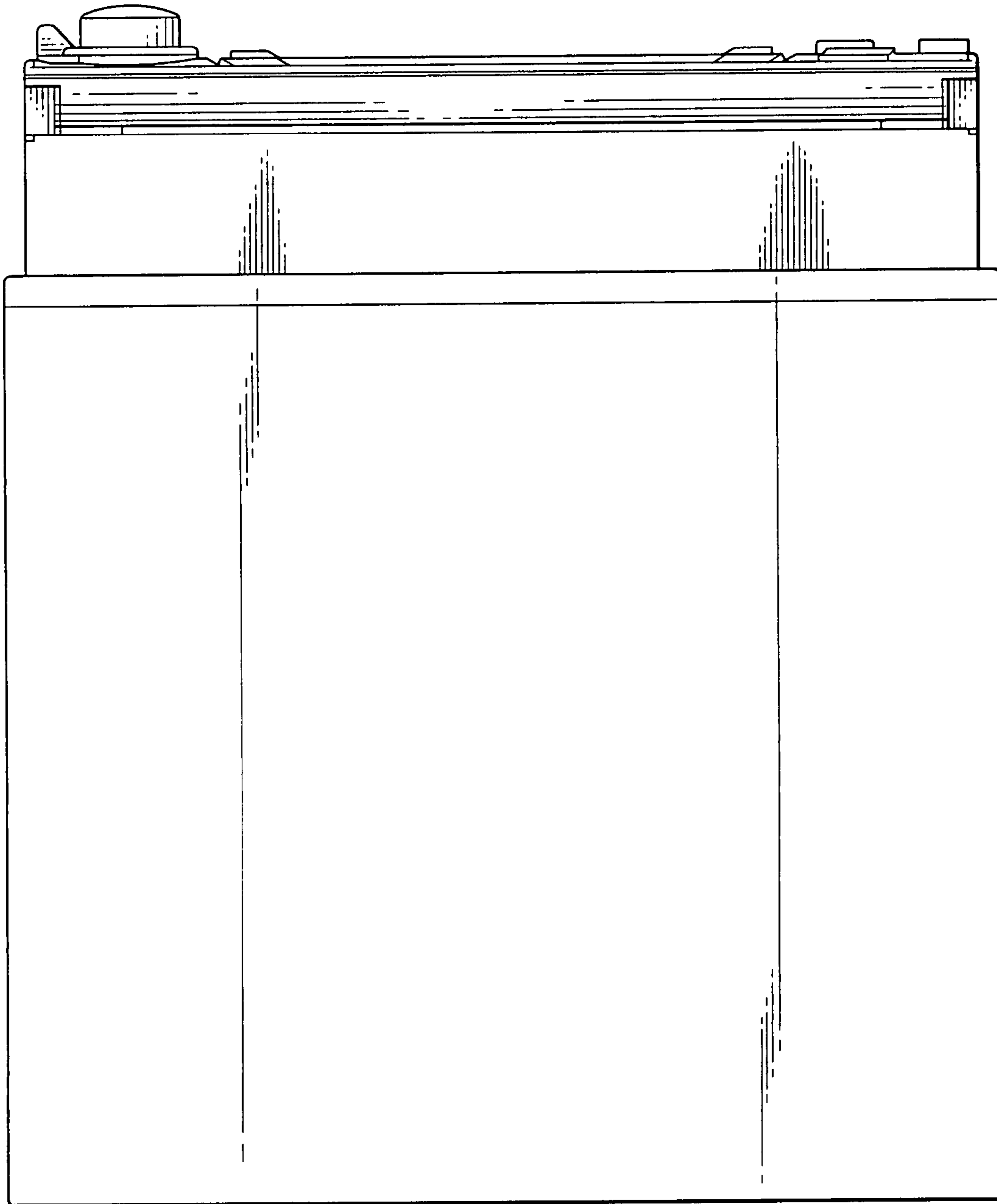

FIG. 14