



US00D567184S

(12) **United States Design Patent**
Victor

(10) **Patent No.:** **US D567,184 S**
(45) **Date of Patent:** **** Apr. 22, 2008**

- (54) **LEVERAGED ELECTRONIC PLUG**
- (76) Inventor: **Jay Victor**, 2017 Bataan Rd., Unit A,
Redondo Beach, CA (US) 90278
- (**) Term: **14 Years**
- (21) Appl. No.: **29/281,958**
- (22) Filed: **Jul. 6, 2007**

Related U.S. Application Data

- (63) Continuation-in-part of application No. 11/555,838,
filed on Nov. 2, 2006, now abandoned, which is a
continuation of application No. 11/266,130, filed on
Nov. 2, 2005, now abandoned.
- (51) **LOC (8) Cl.** **13-03**
- (52) **U.S. Cl.** **D13/156**
- (58) **Field of Classification Search** D13/133,
D13/154, 156, 184; 439/447, 483, 586, 578,
439/606-610, 668-669, 675-676, 889, 892
See application file for complete search history.

(56) **References Cited**

U.S. PATENT DOCUMENTS

3,297,975	A *	1/1967	Pope	439/889
D320,192	S *	9/1991	Sisk	D13/133
5,183,411	A *	2/1993	Yu	439/578
D407,378	S *	3/1999	Lee	D13/156
D453,322	S *	2/2002	Lee	D13/154
D473,194	S *	4/2003	Lee	D13/154
D506,184	S *	6/2005	Sirichai et al.	D13/154
D542,224	S *	5/2007	Victor	D13/154
D543,154	S *	5/2007	Suckle et al.	D13/154
D543,509	S *	5/2007	Victor	D13/154
D549,174	S *	8/2007	Lee et al.	D13/133

* cited by examiner

Primary Examiner—Brian N Vinson
(74) *Attorney, Agent, or Firm*—Trojan Law Offices

(57) **CLAIM**

The ornamental design for a leveraged electronic plug, as shown and described.

DESCRIPTION

FIG. 1 is a rear perspective view of a leveraged electronic plug, showing my new design;
 FIG. 2 is a top perspective view of the leveraged electronic plug shown in FIG. 1;
 FIG. 3 is a front perspective view of the leveraged electronic plug shown in FIG. 1;
 FIG. 4 is a top view of the leveraged electronic plug shown in FIG. 1; a bottom view of the leveraged electronic plug shown in FIG. 1 is a mirror image of the top view shown;
 FIG. 5 is a right side view of the leveraged electronic plug shown in FIG. 1;
 FIG. 6 is a left side view of the leveraged electronic plug shown in FIG. 1;
 FIG. 7 is a front view of the leveraged electronic plug shown in FIG. 1; and,
 FIG. 8 is a rear view of the leveraged electronic plug shown in FIG. 1.

The broken lines showing a pin and a head next to the pin in FIGS. 1 through 7 and a cable line in FIGS. 1 through 6 and 8 are for illustrative purposes only and form no part of the claimed design.

1 Claim, 5 Drawing Sheets

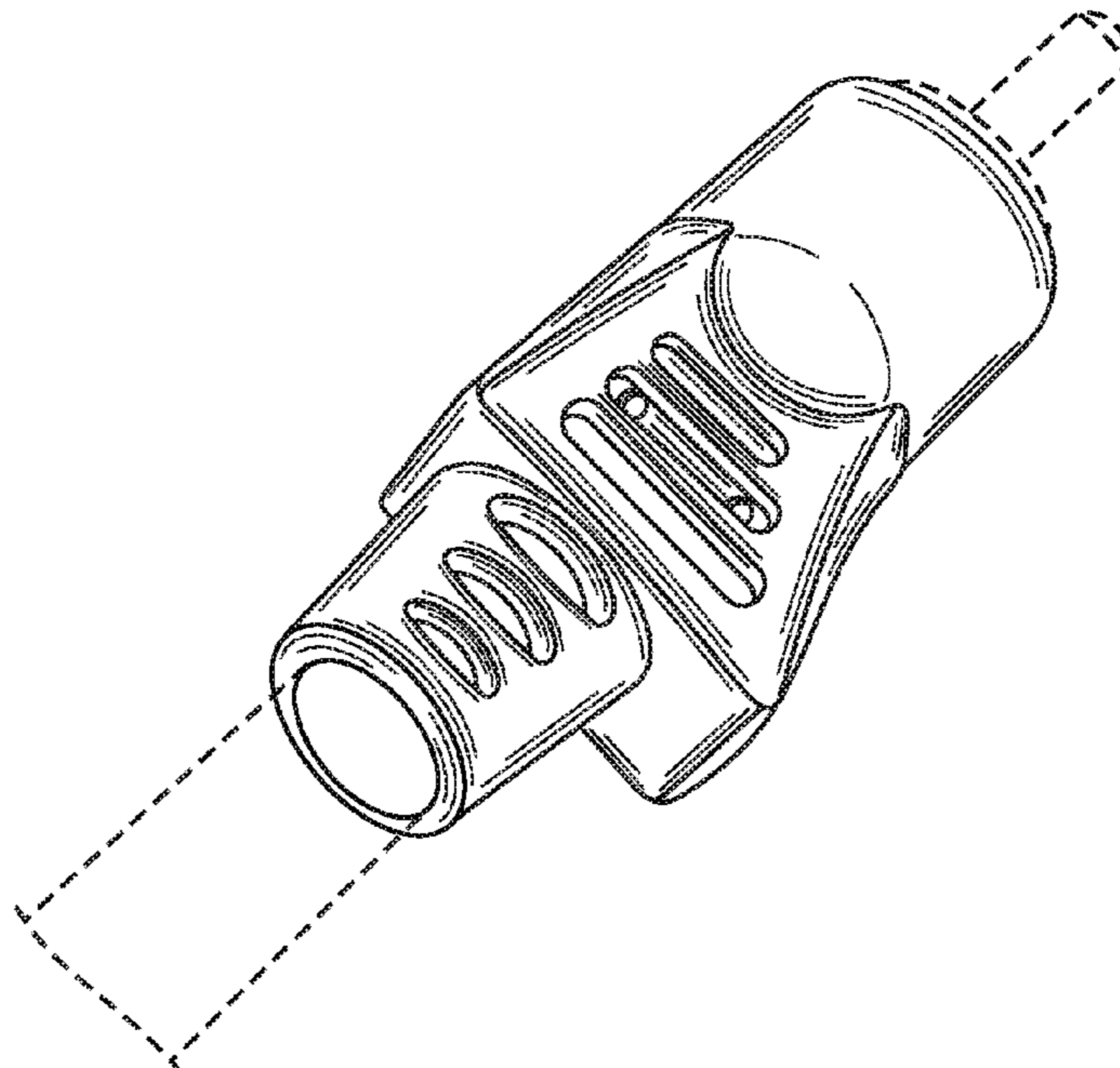

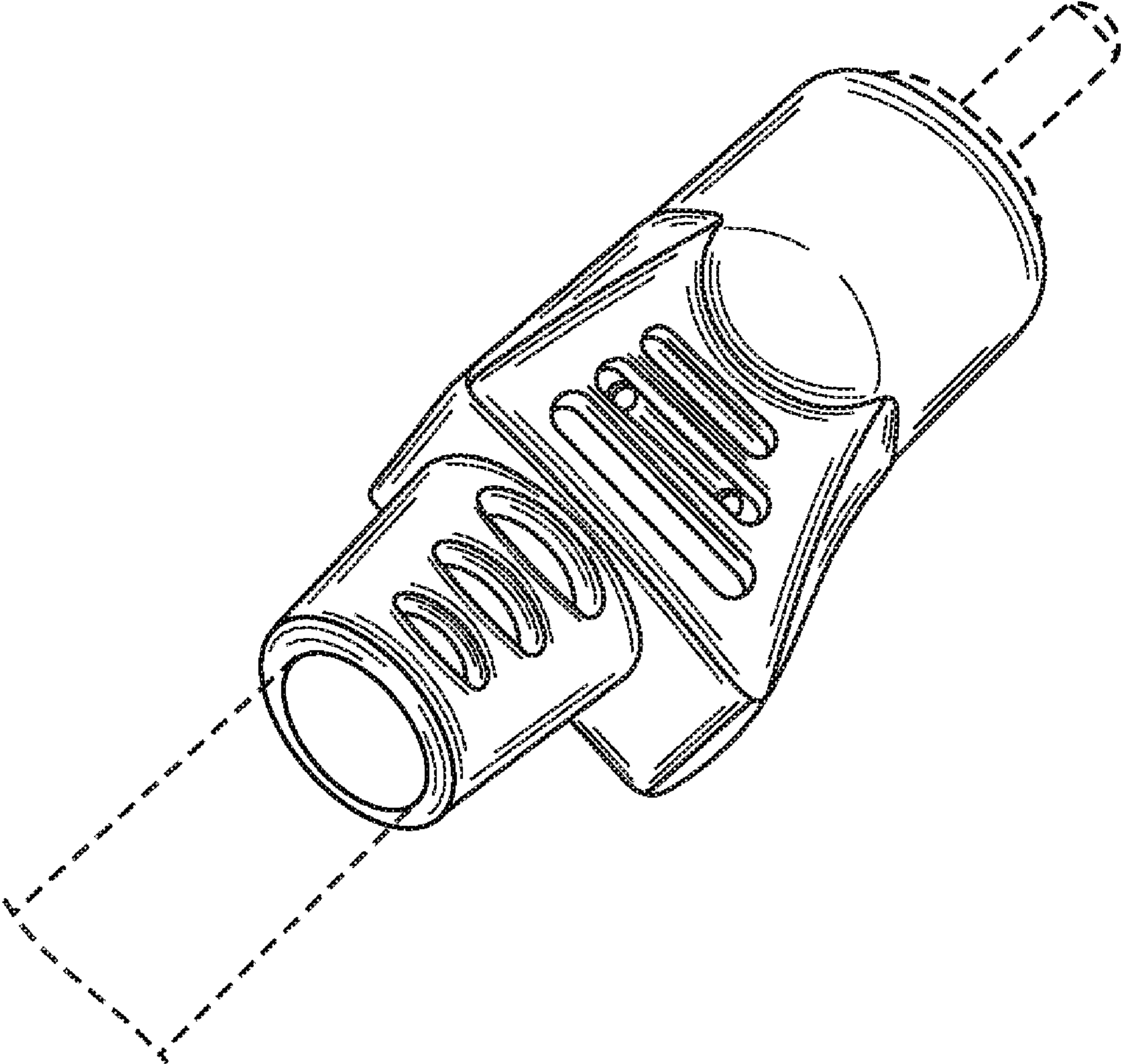

FIG. 1

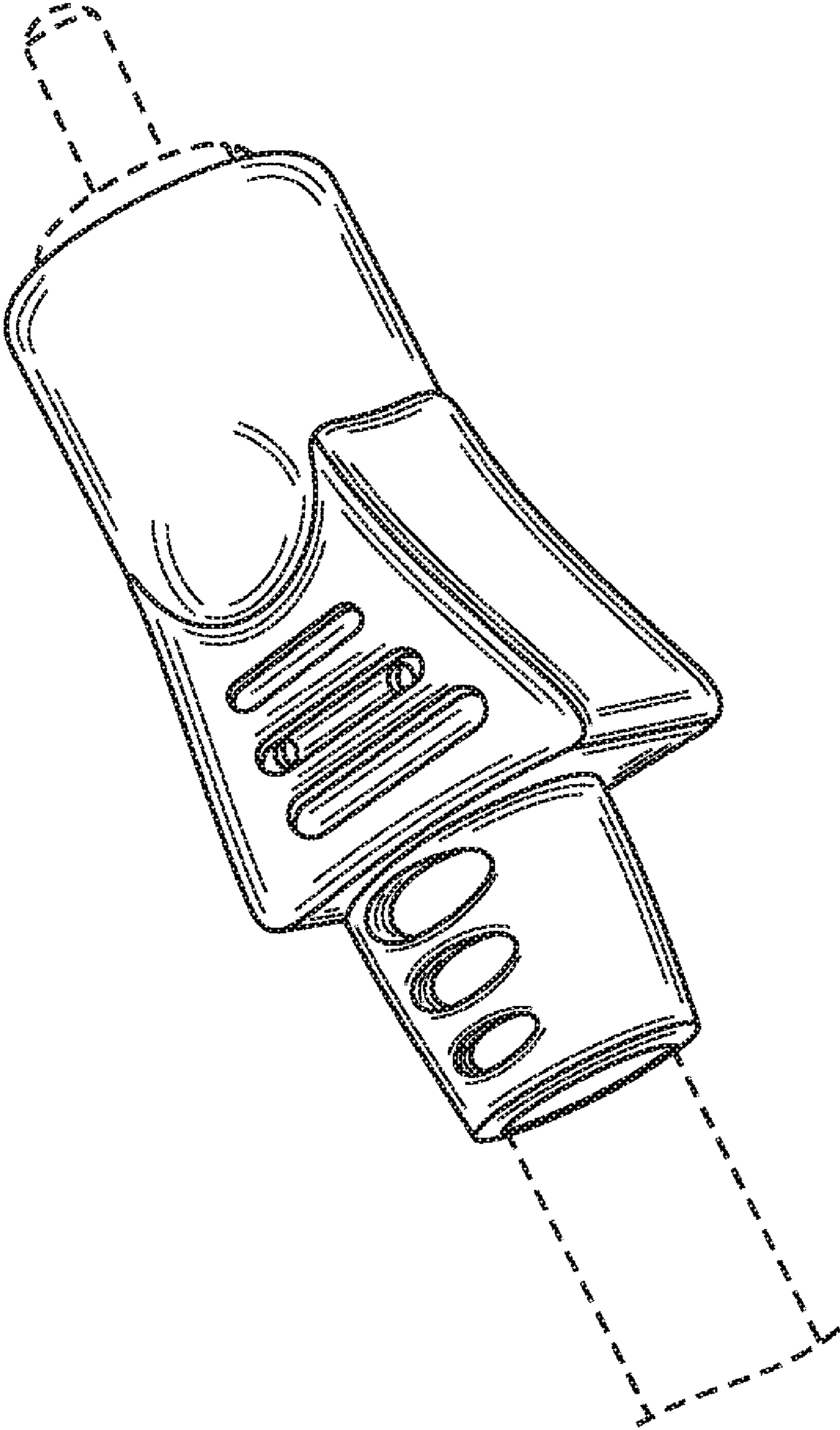

FIG. 2

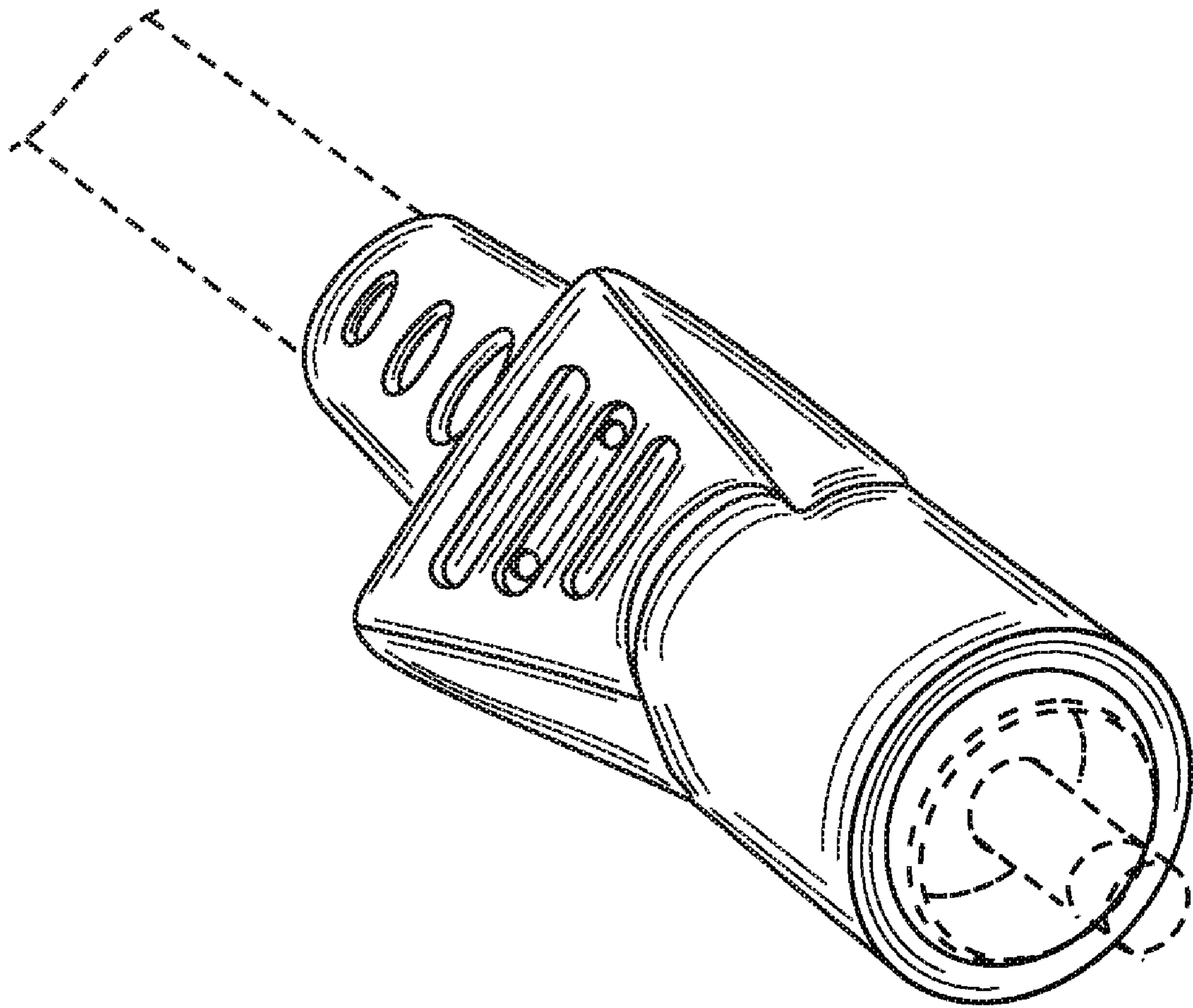

FIG. 3

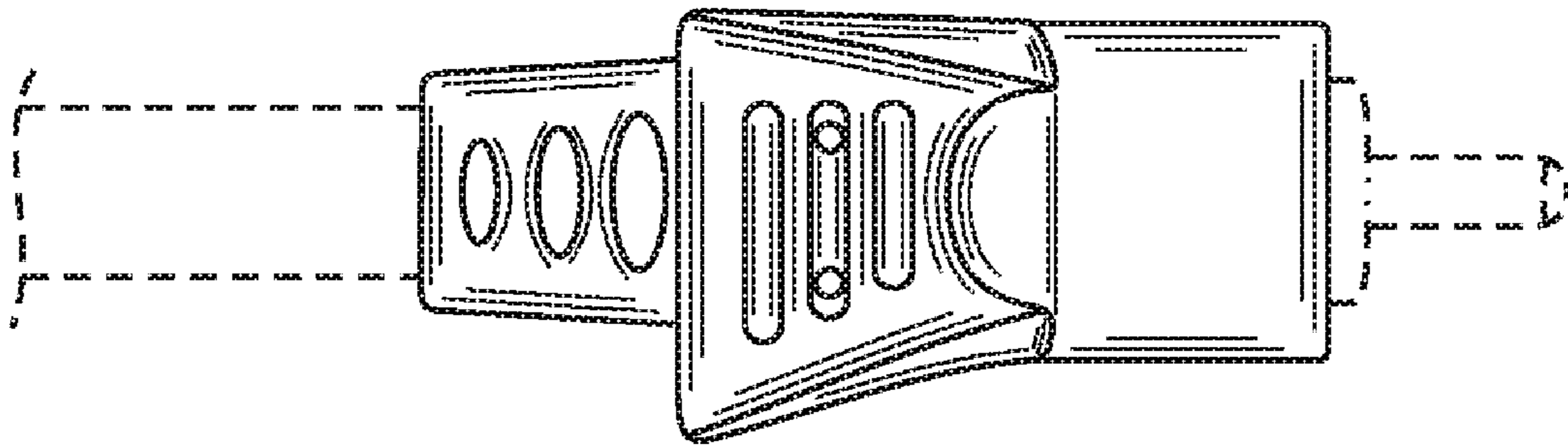

FIG. 4

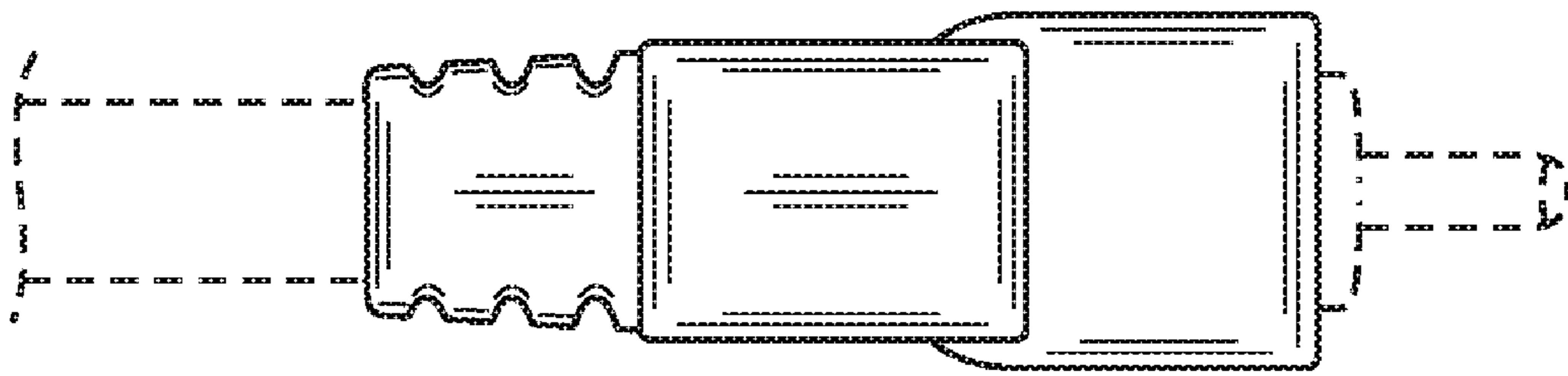

FIG. 5

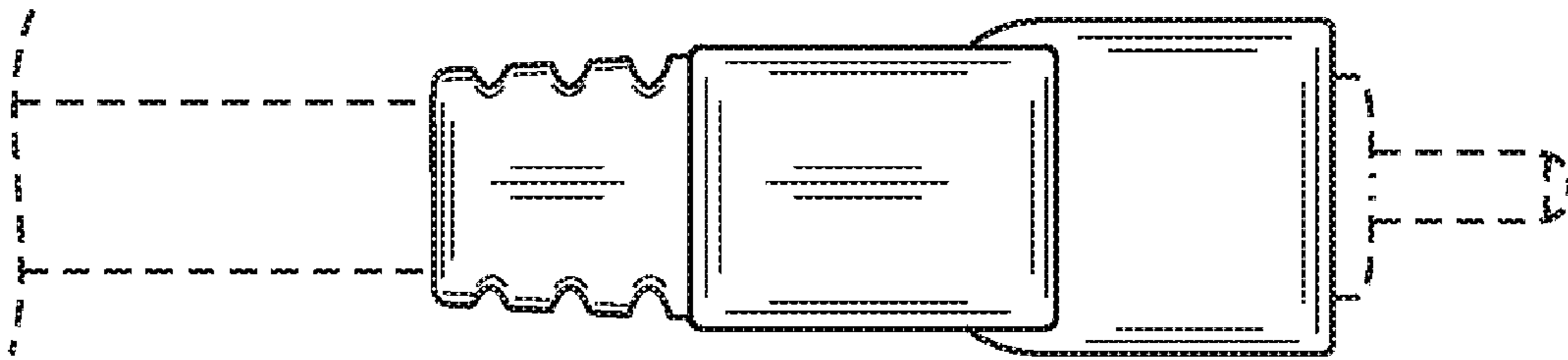

FIG. 6

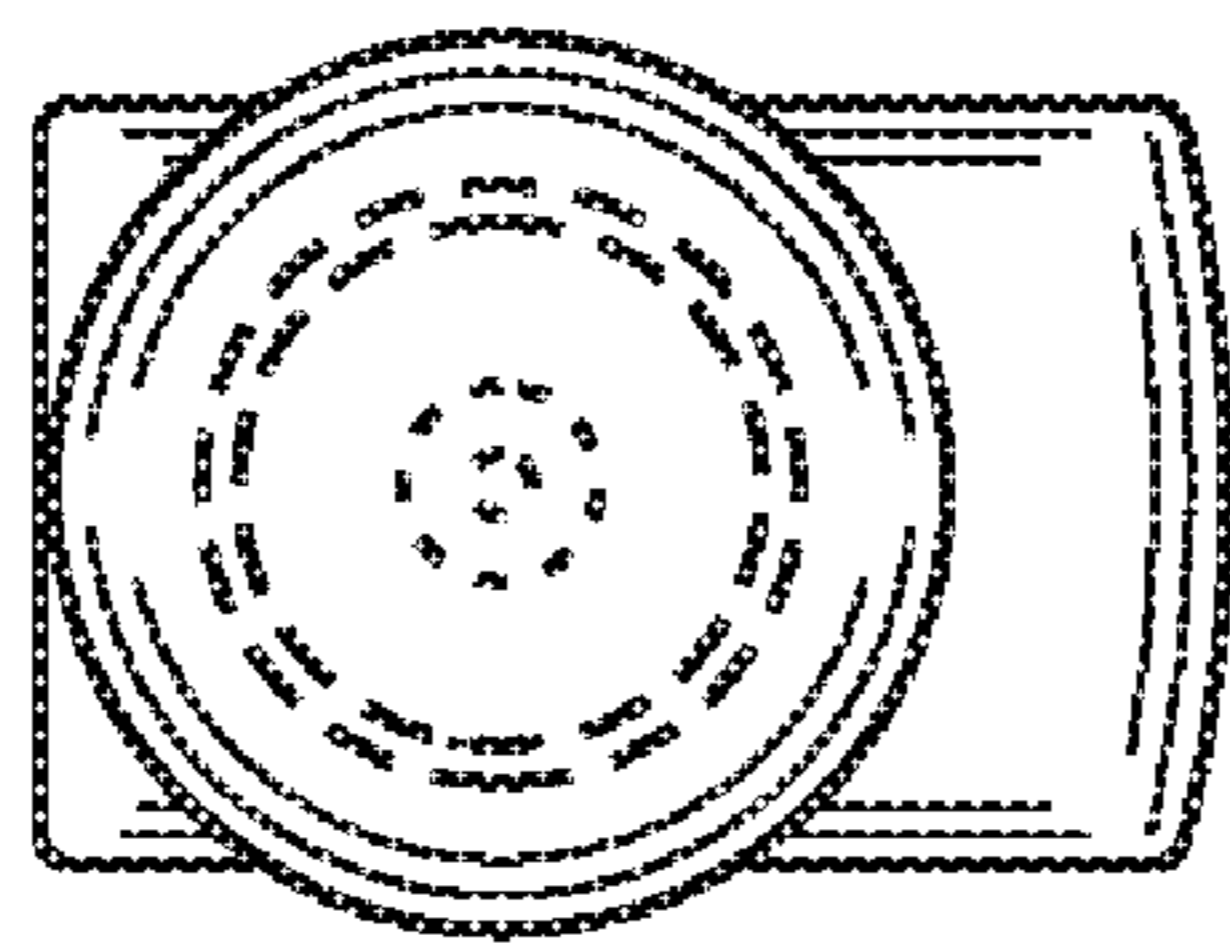

FIG. 7

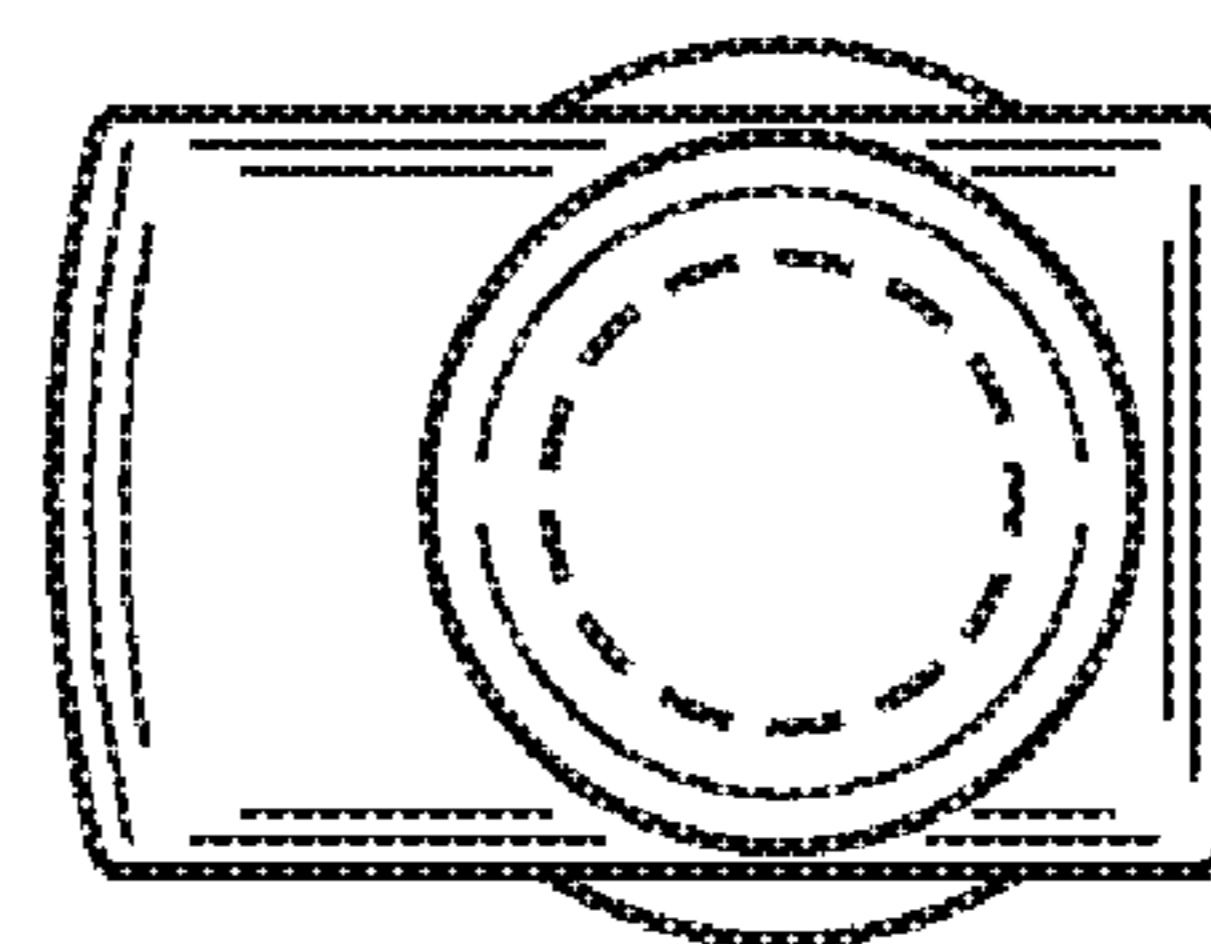

FIG. 8