



US00D567007S

(12) **United States Design Patent**
Bodum

(10) **Patent No.:** **US D567,007 S**

(45) **Date of Patent:** **** Apr. 22, 2008**

(54) **COFFEE POT WITH PLUNGER**

D513,919 S * 1/2006 Bodum D7/319
D542,078 S * 5/2007 Bodum D7/319
D545,111 S * 6/2007 Brown D7/317

(75) Inventor: **Jørgen Bodum**, St. Niklausen (CH)

(73) Assignee: **Pi-Design AG**, Triengen (CH)

* cited by examiner

(**) Term: **14 Years**

Primary Examiner—Marianne Pandozzi

(21) Appl. No.: **29/278,709**

(74) *Attorney, Agent, or Firm*—Cowan, Liebowitz & Latman, PC

(22) Filed: **Apr. 6, 2007**

(57) **CLAIM**

(30) **Foreign Application Priority Data**

The ornamental design for a coffee pot with plunger, as shown and described.

Oct. 6, 2006 (DK) DA 2006 00270

DESCRIPTION

(51) **LOC (8) Cl.** **07-01**

FIG. 1 is a perspective view of the coffee pot with plunger, showing my design thereof;

(52) **U.S. Cl.** **D7/319; D7/317**

FIG. 2 is a front view thereof;

(58) **Field of Classification Search** D7/317,

D7/318, 319, 321, 316; 99/323, 295; 220/592.22,
220/717; 222/465.1; 446/479

FIG. 3 is a back view thereof;

See application file for complete search history.

FIG. 4 is a right side view thereof;

FIG. 5 is a left side view thereof;

(56) **References Cited**

U.S. PATENT DOCUMENTS

D377,132 S * 1/1997 J.o slashed.rgensen D7/318

D405,642 S * 2/1999 Toriba D7/319

D483,599 S * 12/2003 Huang D7/319

FIG. 6 is a top view thereof; and,

FIG. 7 is a bottom view thereof.

1 Claim, 7 Drawing Sheets

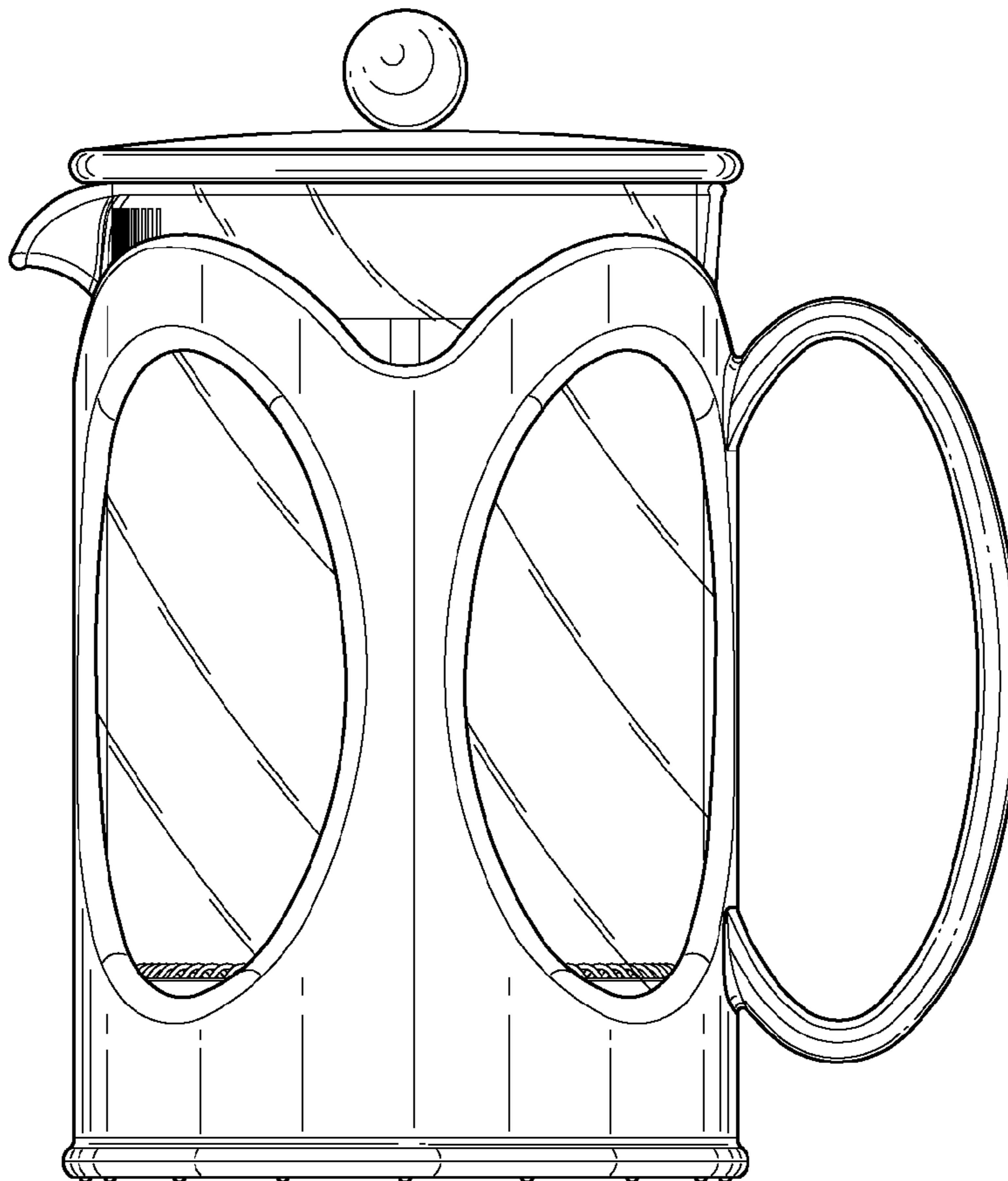

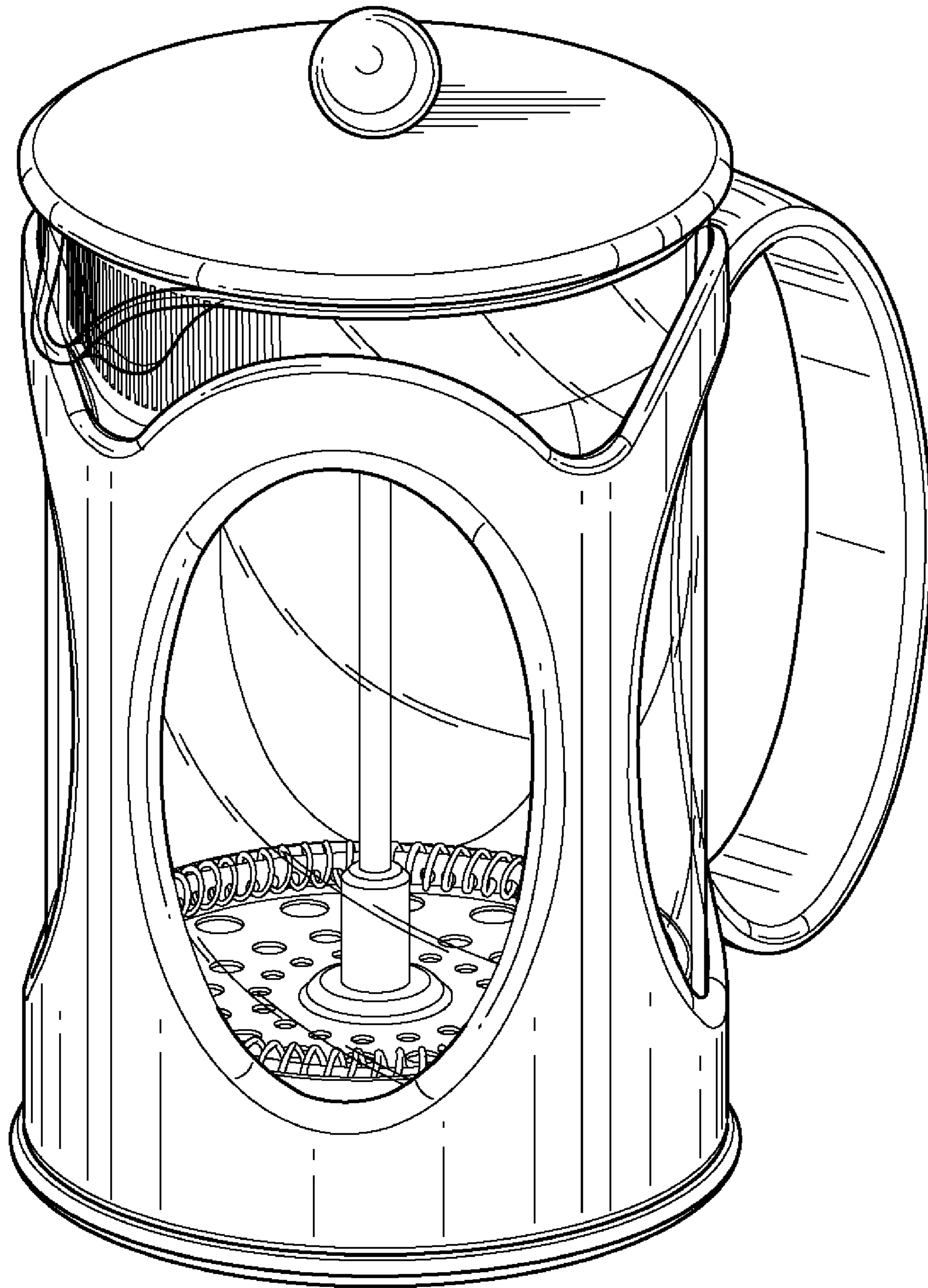

FIG. 1

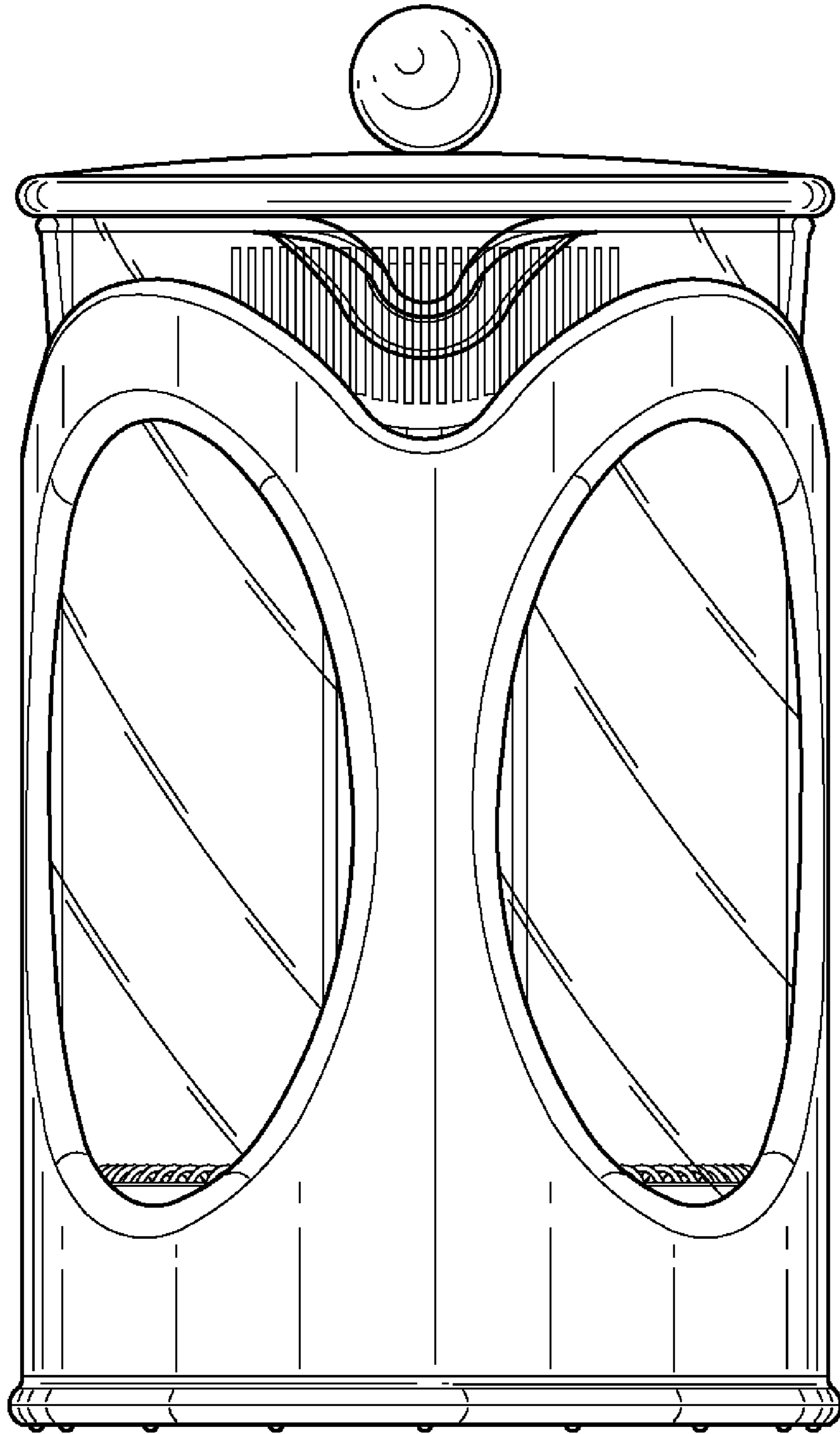

FIG. 2

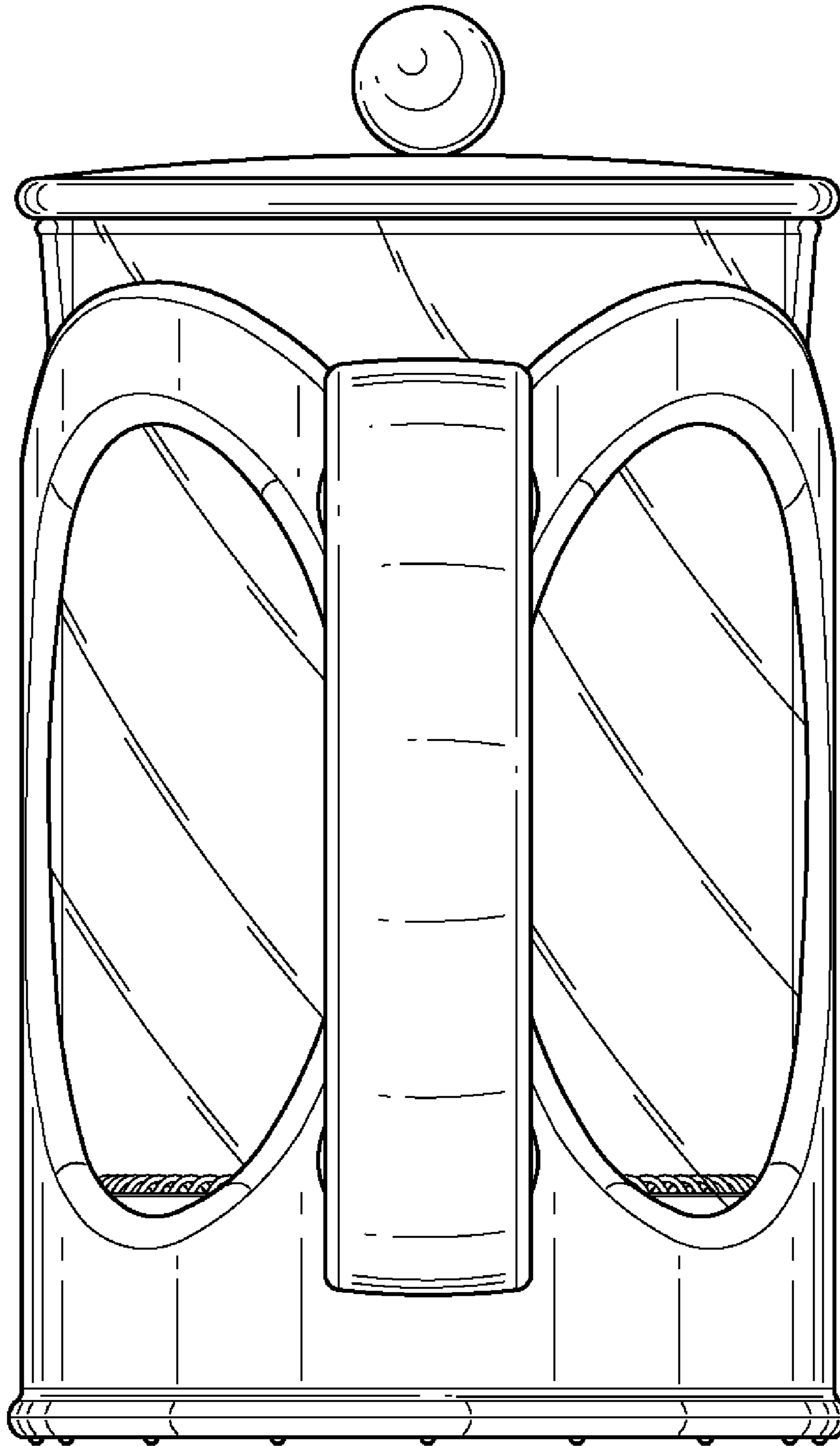

FIG. 3

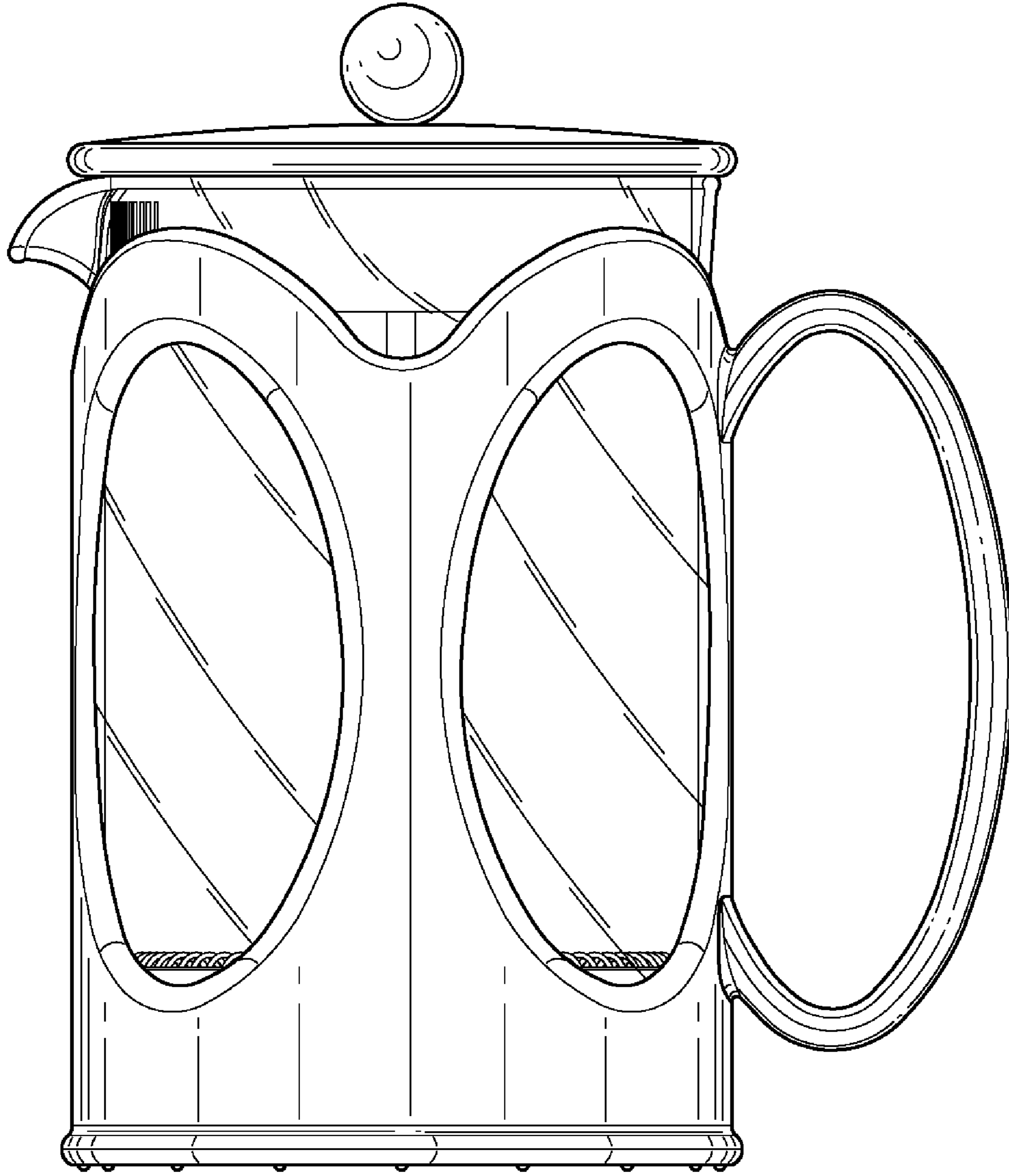

FIG. 4

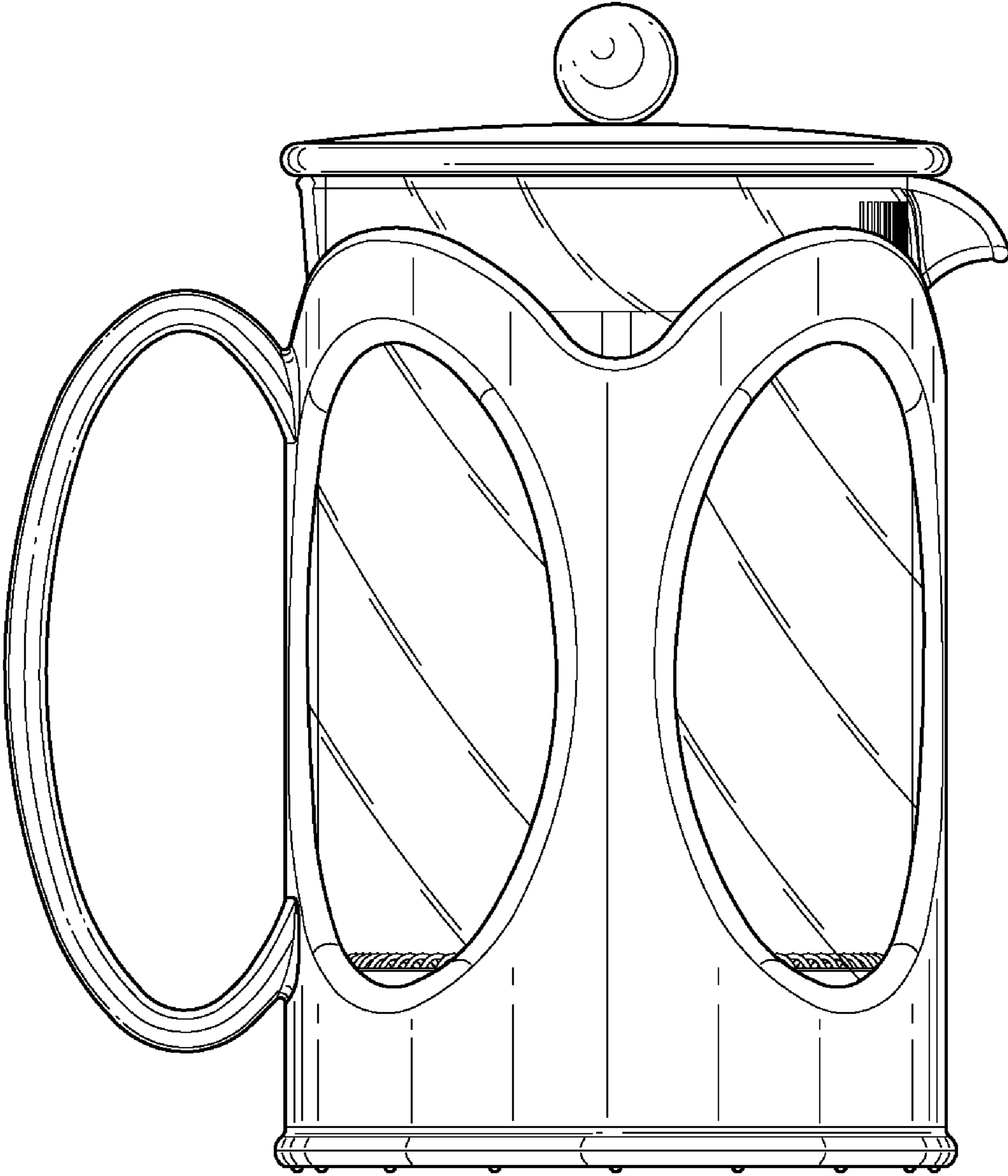

FIG. 5

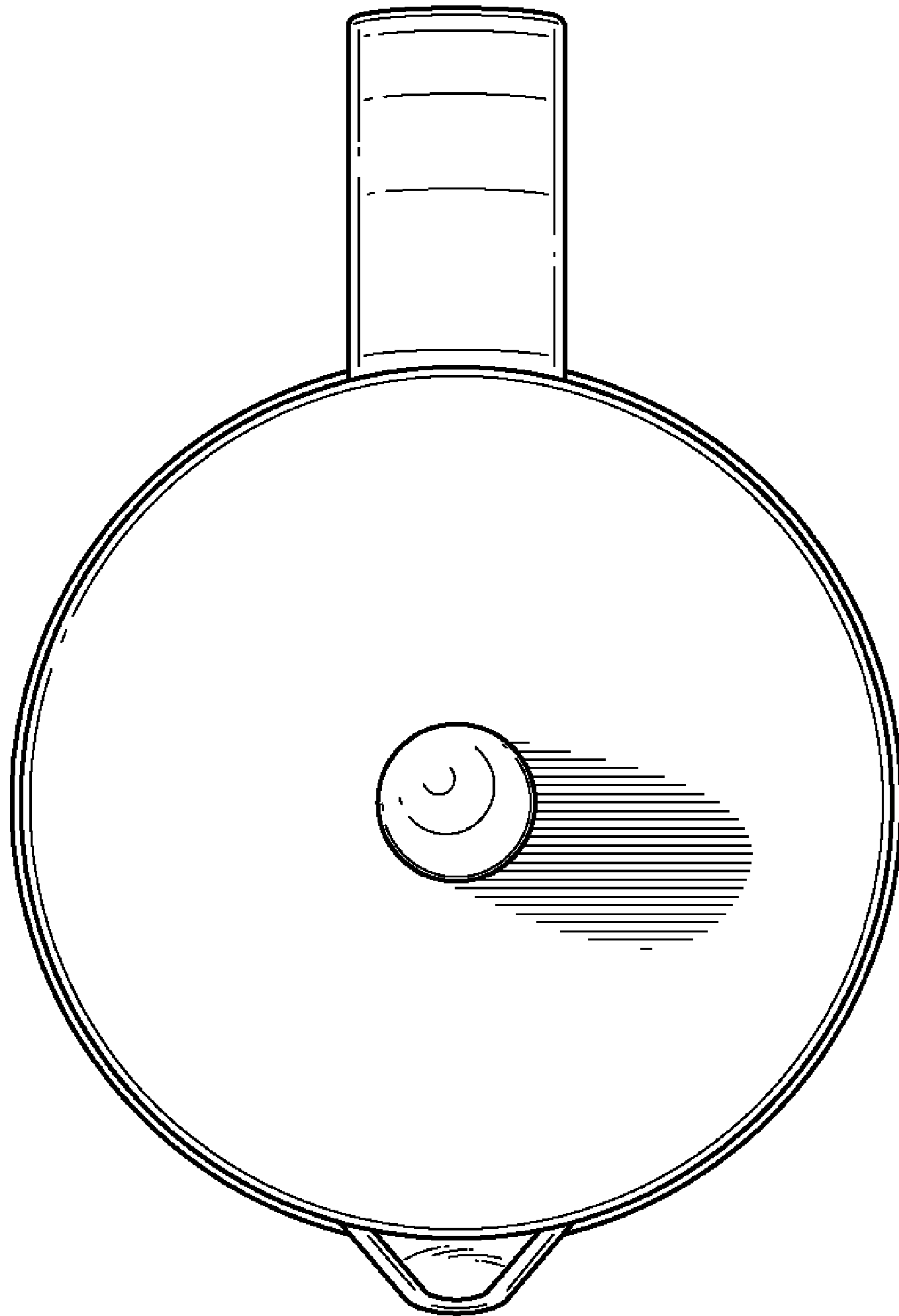

FIG. 6

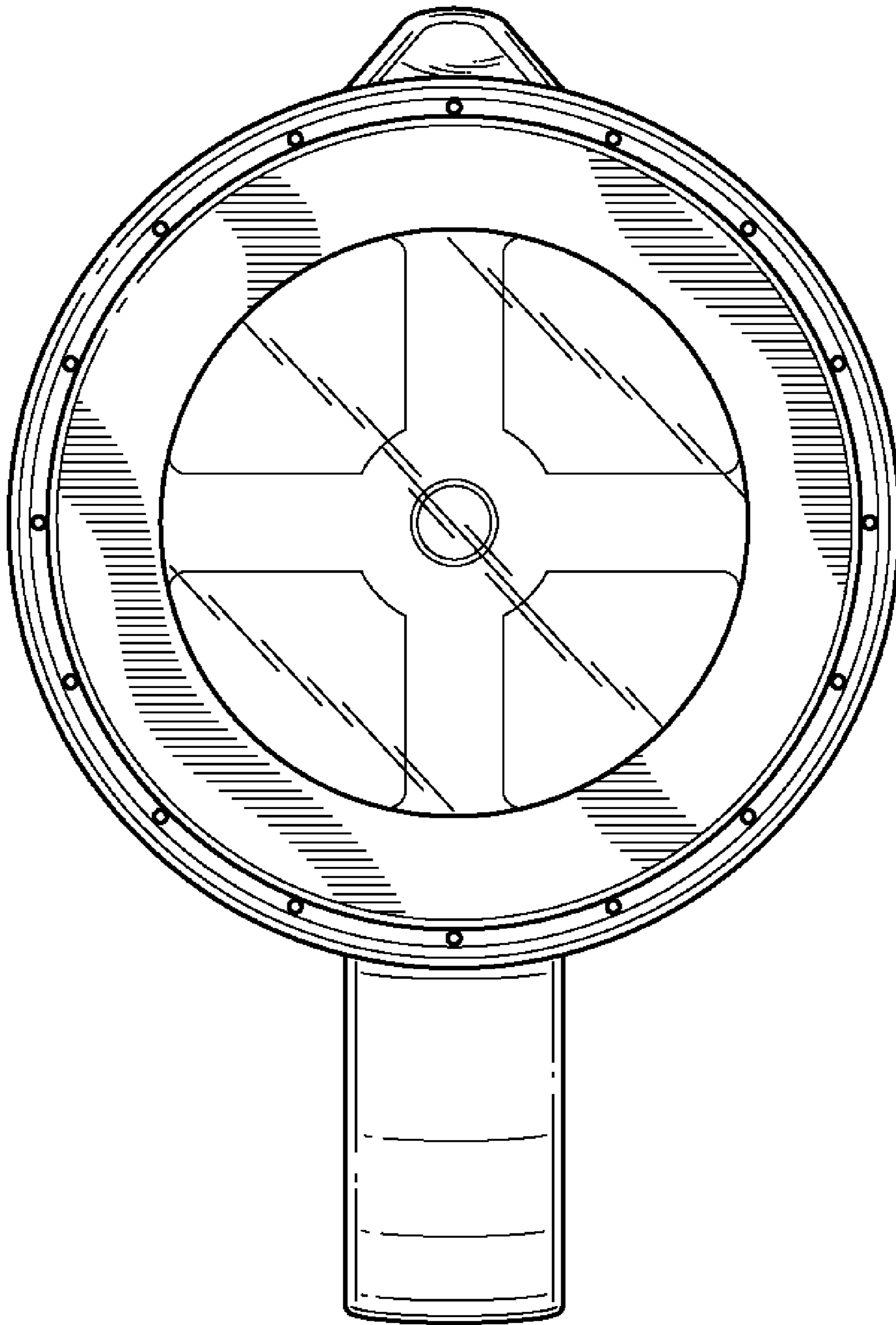

FIG. 7