



US00D566951S

(12) **United States Design Patent**
Belley et al.

(10) **Patent No.:** **US D566,951 S**

(45) **Date of Patent:** **** Apr. 22, 2008**

(54) **FOOTWEAR UPPER**

(75) Inventors: **Manon Belley**, Laval (CA); **Julie St. Louis**, Montreal (CA)

(73) Assignee: **Wolverine World Wide, Inc.**,
Rockford, MI (US)

(**) Term: **14 Years**

(21) Appl. No.: **29/268,693**

(22) Filed: **Nov. 9, 2006**

(51) **LOC (8) Cl.** **02-99**

(52) **U.S. Cl.** **D2/969**

(58) **Field of Classification Search** D2/902,
D2/906-908, 943, 944, 969, 972-974, 946,
D2/924, 926; 36/45, 50.1, 83, 88, 113, 114,
36/126-130, 11

See application file for complete search history.

(56) **References Cited**

U.S. PATENT DOCUMENTS

D476,796 S	*	7/2003	Meza et al.	D2/902
D500,406 S		1/2005	Belley et al.		
D501,295 S		2/2005	Belley et al.		
D503,523 S		4/2005	Matis et al.		
D532,191 S		11/2006	Belley et al.		
D538,517 S	*	3/2007	Della Valle	D2/907
D538,518 S	*	3/2007	Della Valle	D2/907
D540,019 S	*	4/2007	Belley et al.	D2/969
D547,535 S	*	7/2007	Matis et al.	D2/969

OTHER PUBLICATIONS

CAT Footwear 1997 Catalog, p. 32.
Hush Puppies Kids 1997 Catalog, p. 4.

* cited by examiner

Primary Examiner—Dominic Simone

(74) *Attorney, Agent, or Firm*—Warner Norcross & Judd
LLP

(57) **CLAIM**

The ornamental design for footwear upper, as shown and described.

DESCRIPTION

FIG. 1 is a perspective view of the footwear upper embodying the new design;

FIG. 2 is a top view thereof;

FIG. 3 is a right side view thereof;

FIG. 4 is a left side view thereof;

FIG. 5 is a front view thereof; and,

FIG. 6 is a rear view thereof.

FIGS. 1-6 show features of an article of footwear in phantom lines. These features are shown for environmental purposes and do not form any part of the claimed design. Further, the phantom lines immediately adjacent the solid-line portions of the design form the boundary of the design, with the phantom lines forming no part of the claimed design.

1 Claim, 4 Drawing Sheets

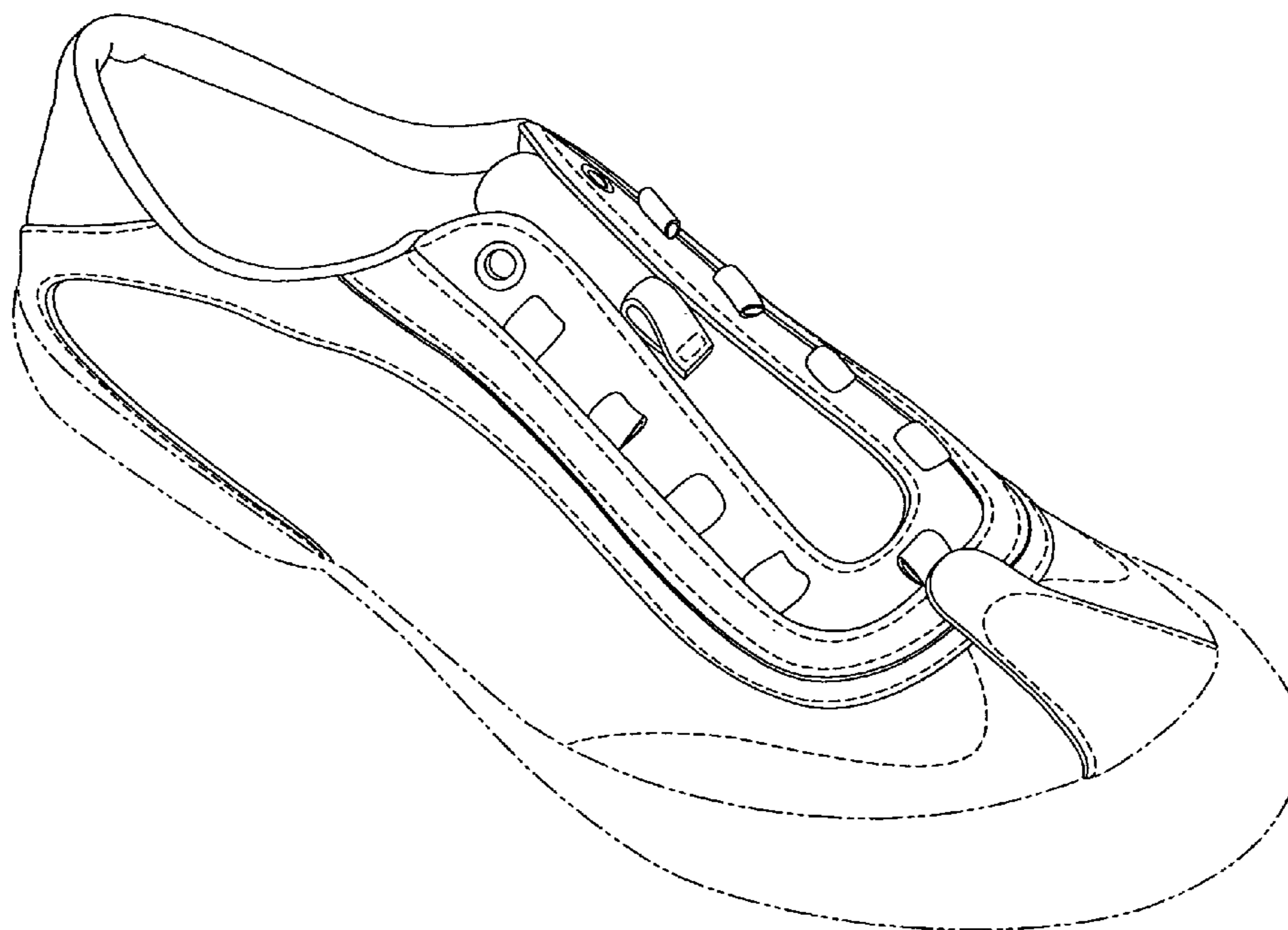

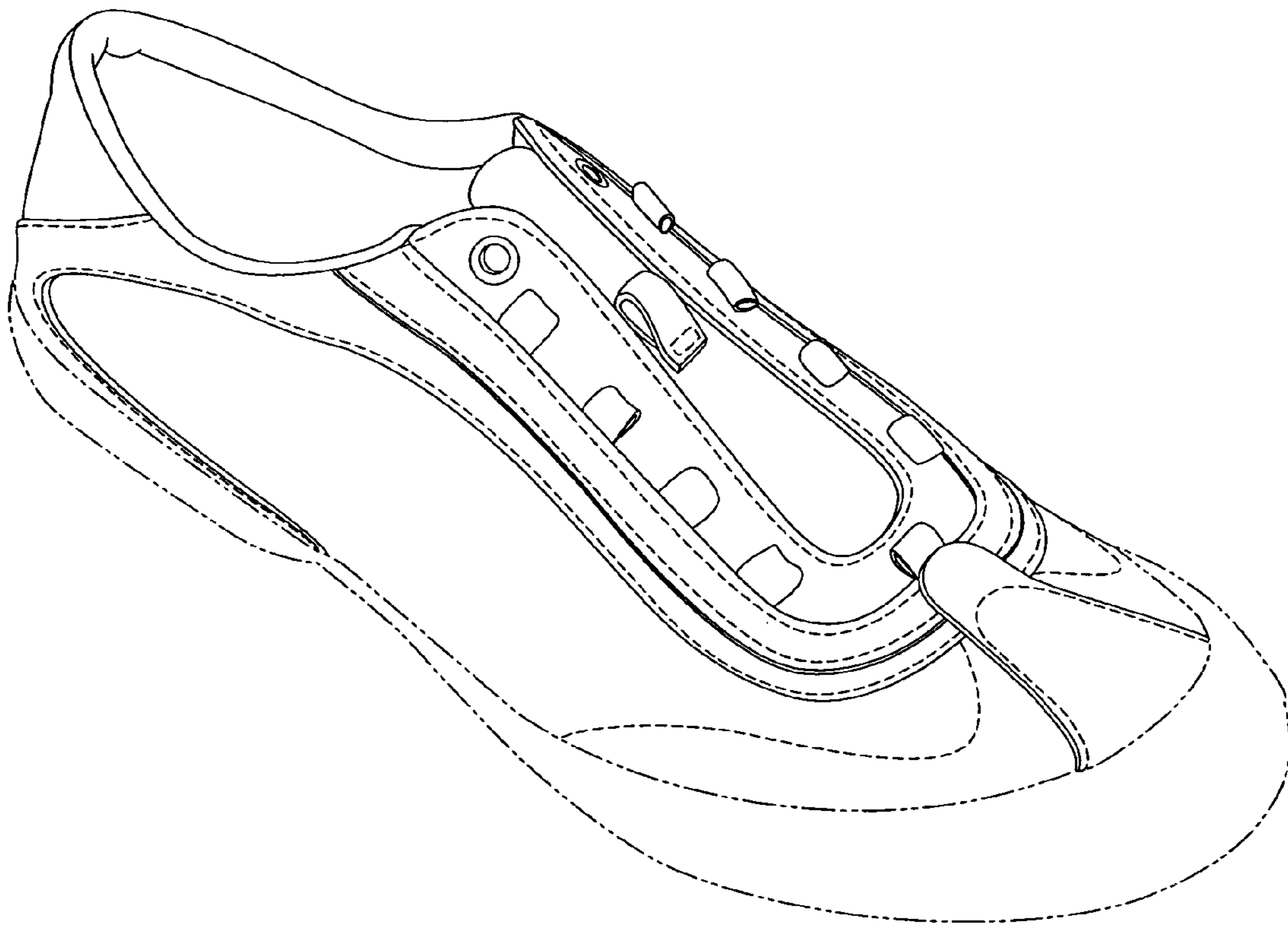

Fig.1

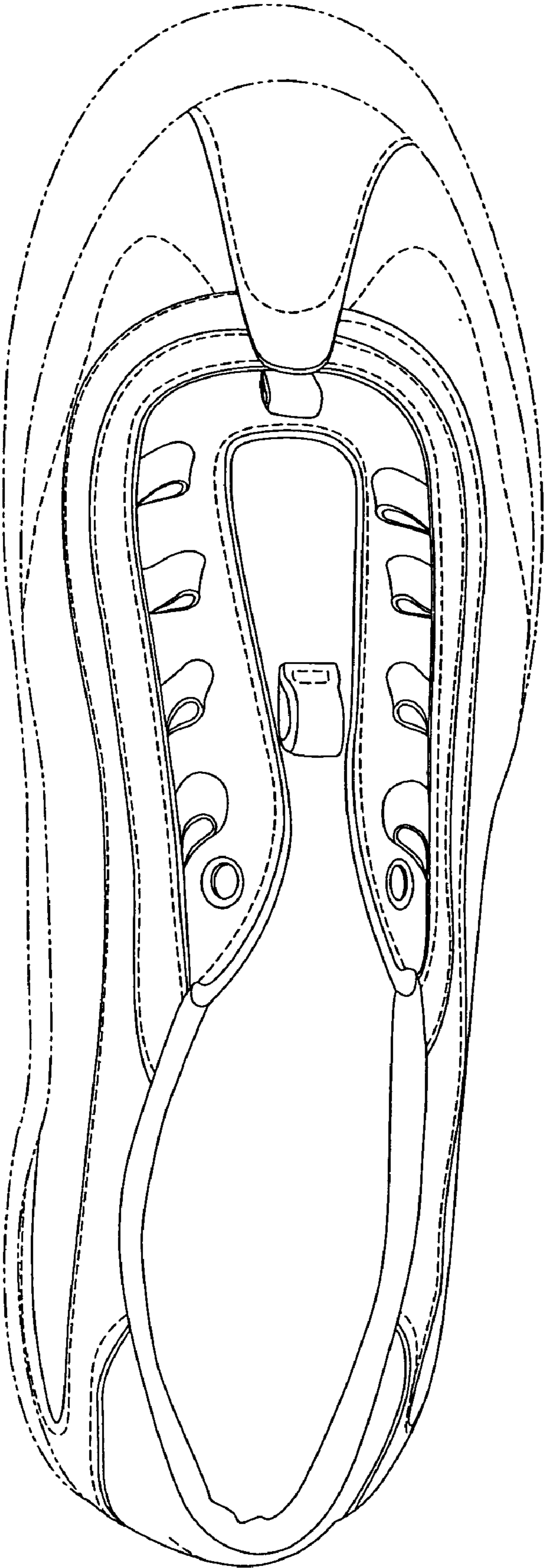

Fig.2

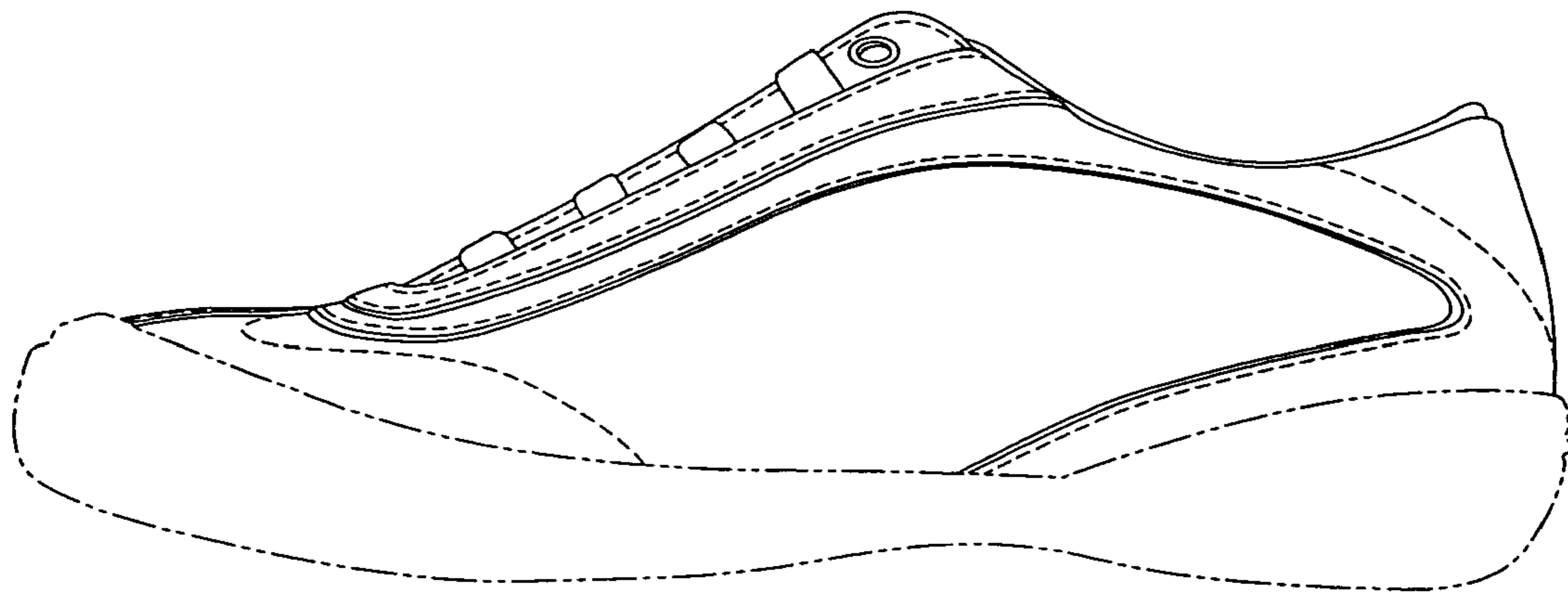

Fig.3

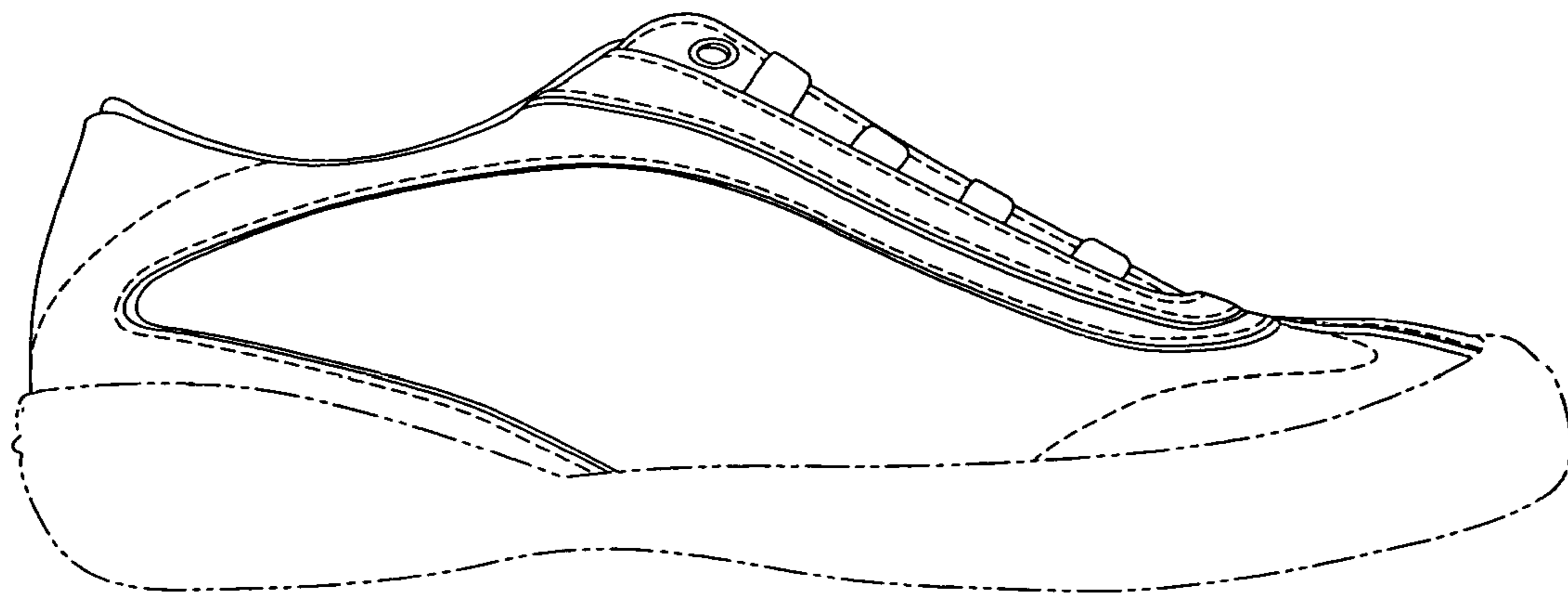

Fig.4

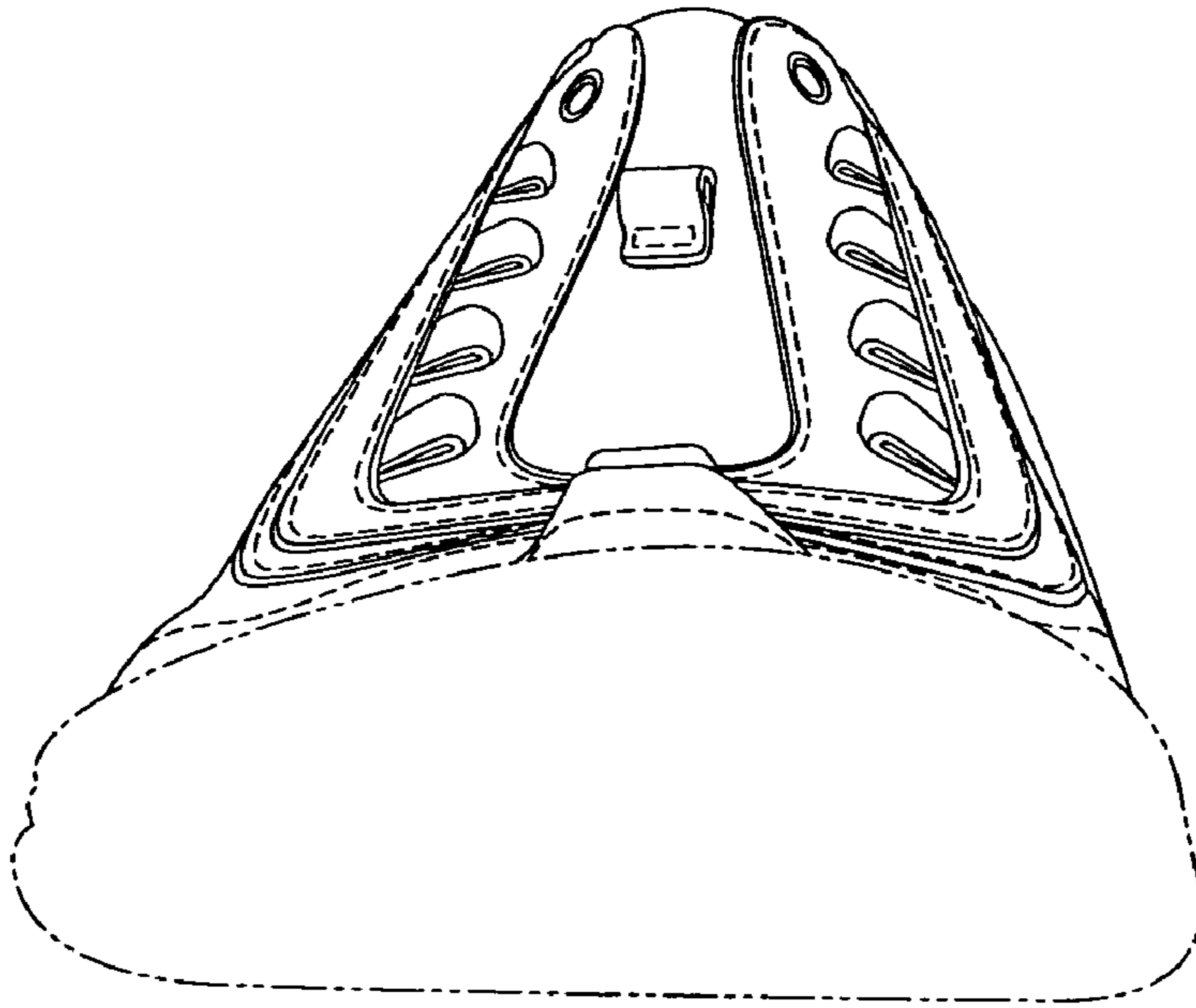

Fig.5

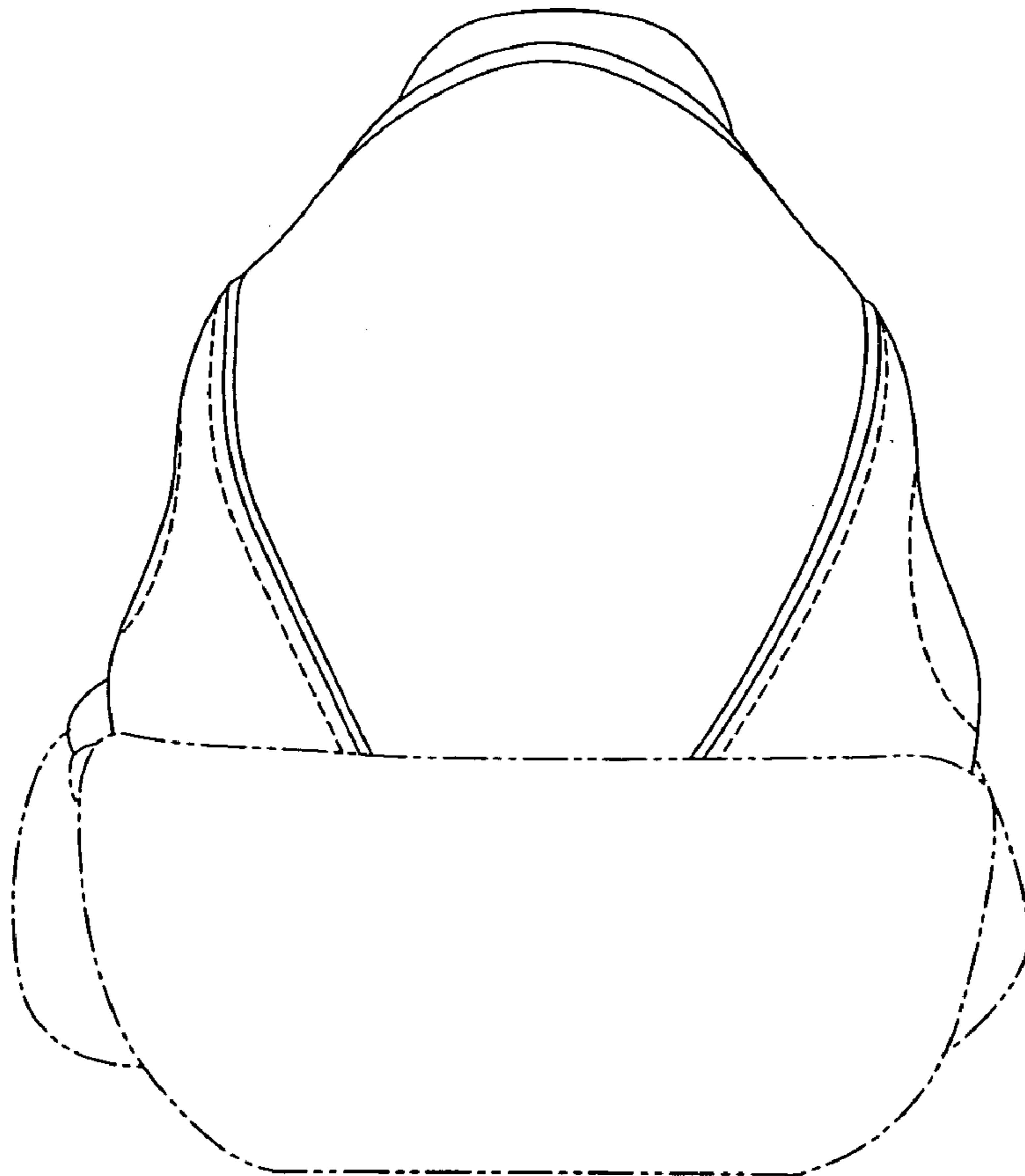

Fig.6