



US00D566919S

(12) **United States Design Patent**
Snell

(10) **Patent No.:** **US D566,919 S**

(45) **Date of Patent:** **** Apr. 15, 2008**

(54) **SUCTION SINK CENTER**

(75) Inventor: **Russell Benton Snell**, Bentleyville, OH (US)

(73) Assignee: **InterDesign, Inc.**, Solon, OH (US)

(**) Term: **14 Years**

(21) Appl. No.: **29/272,991**

(22) Filed: **Feb. 23, 2007**

(51) **LOC (8) Cl.** **07-05**

(52) **U.S. Cl.** **D32/55; D6/525**

(58) **Field of Classification Search** D32/55-56;
D6/566, 524-525, 320; D7/637; 211/87.01;
248/206.2-206.3

See application file for complete search history.

(56) **References Cited**

U.S. PATENT DOCUMENTS

D185,899 S *	8/1959	Bernhardt	D32/55
D187,290 S *	2/1960	Miller	D32/55
D363,576 S *	10/1995	Brightbill et al.	D32/55
5,547,087 A *	8/1996	Licari	211/41.2
D419,808 S *	2/2000	Hampshire	D6/553
D449,480 S *	10/2001	Snell	D6/566
6,886,792 B2 *	5/2005	Immerman	248/206.3
7,080,416 B1 *	7/2006	Portnell	4/559

OTHER PUBLICATIONS

2005 *bath housewares storage*, p. 19, InterDesign, Inc. product brochure w/front & back cover.

* cited by examiner

Primary Examiner—Pamela J. Burgess

(74) *Attorney, Agent, or Firm*—D. Peter Hochberg; Sean F. Mellino

(57) **CLAIM**

The ornamental design for a suction sink center, as shown and described.

DESCRIPTION

FIG. 1 is a perspective view of the suction sink center according to the invention;

FIG. 2 is a top view of the suction sink center as shown in FIG. 1;

FIG. 3 is a front view of the suction sink center as shown in FIG. 1;

FIG. 4 is a side view of the suction sink center as shown in FIG. 1;

FIG. 5 is a rear view of the suction sink center as shown in FIG. 1;

FIG. 6 is a side view of the suction sink center as shown in FIG. 1, shown from the opposite side as that shown in FIG. 4; and,

FIG. 7 is a bottom view of the suction sink center, as shown in FIG. 1.

1 Claim, 3 Drawing Sheets

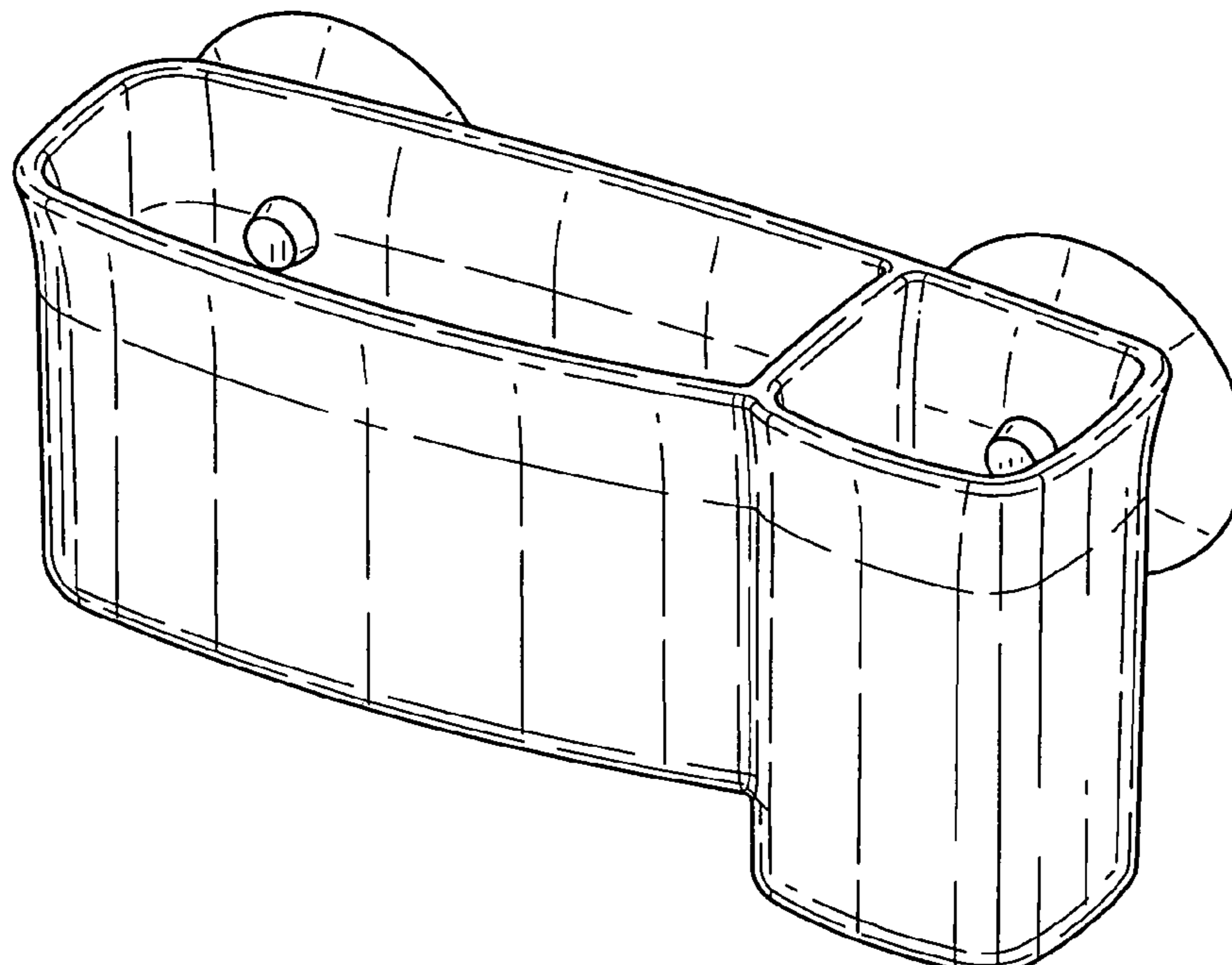

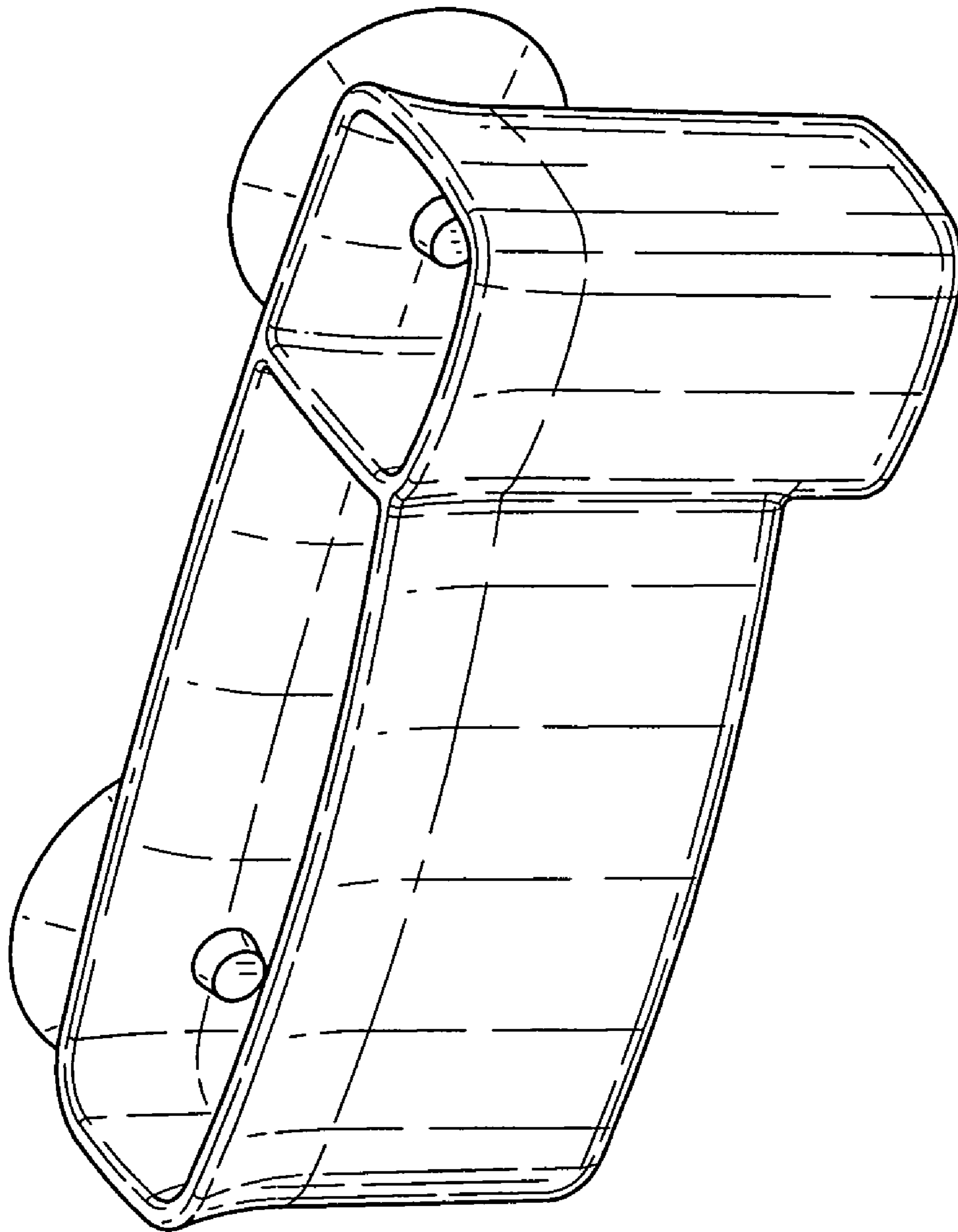

FIG-1

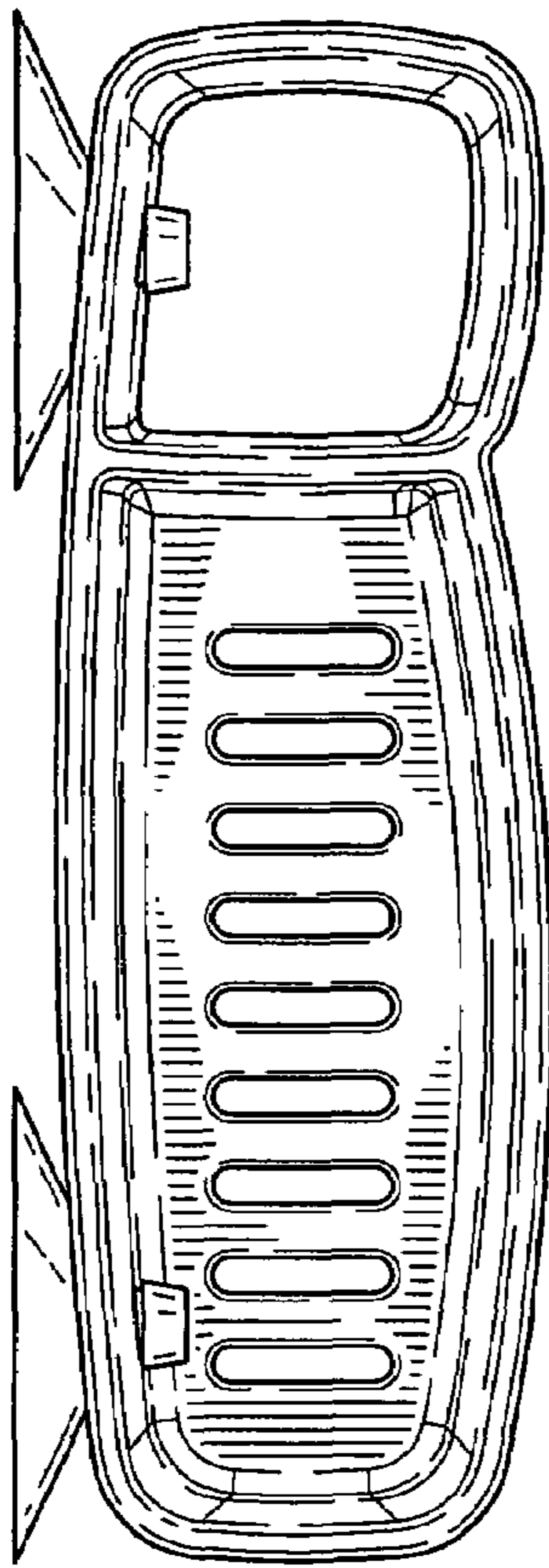

FIG-2

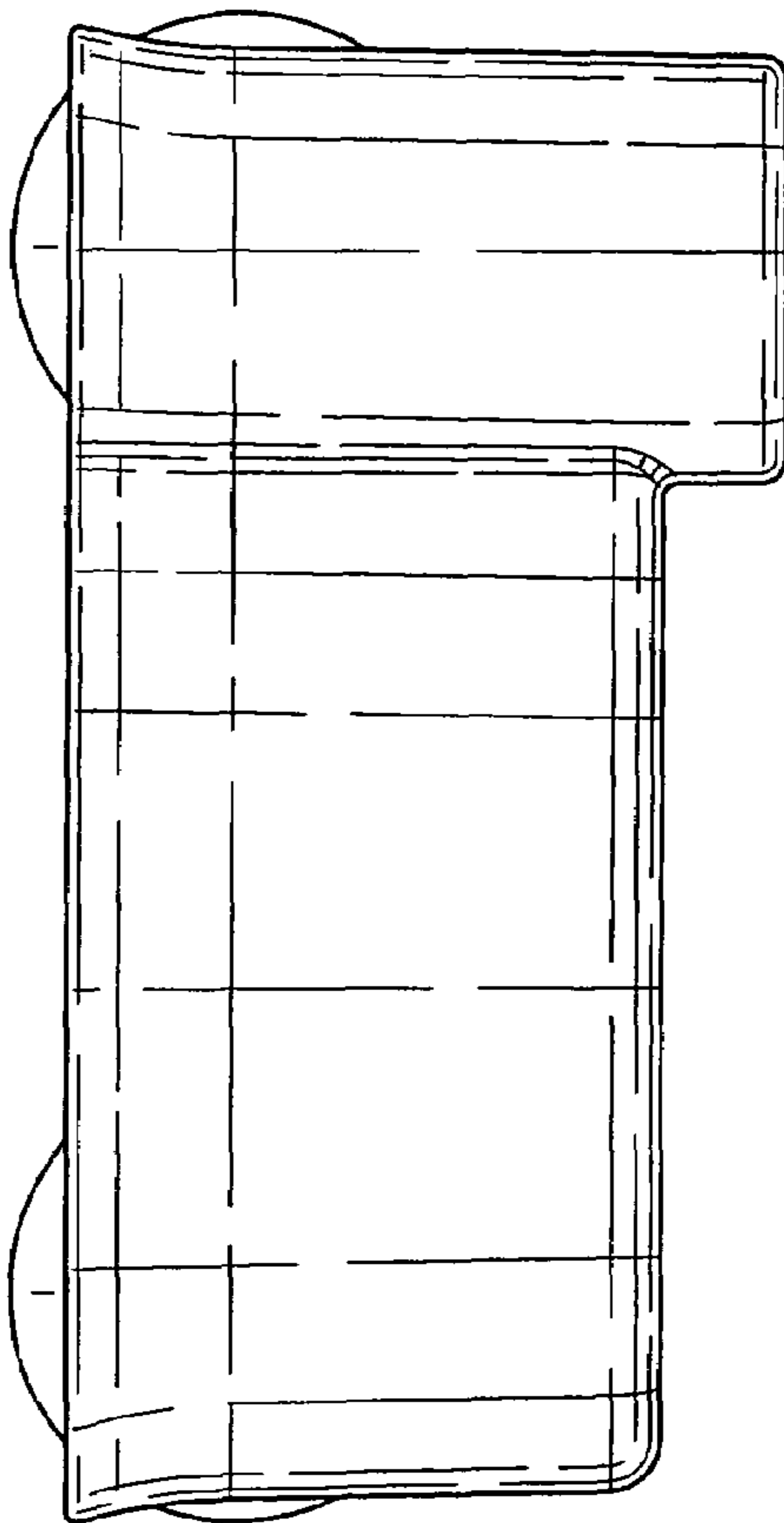

FIG-3

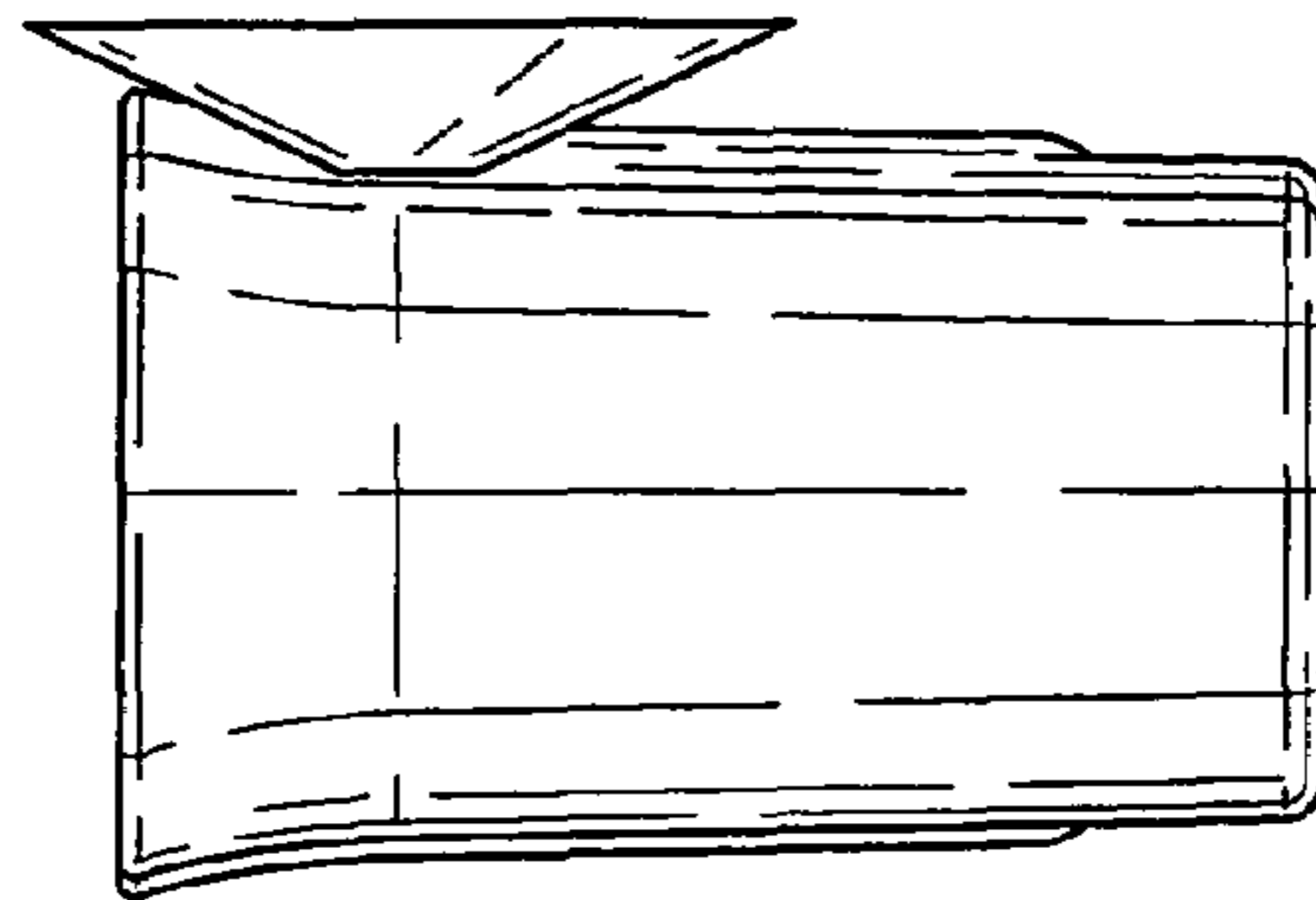

FIG-4

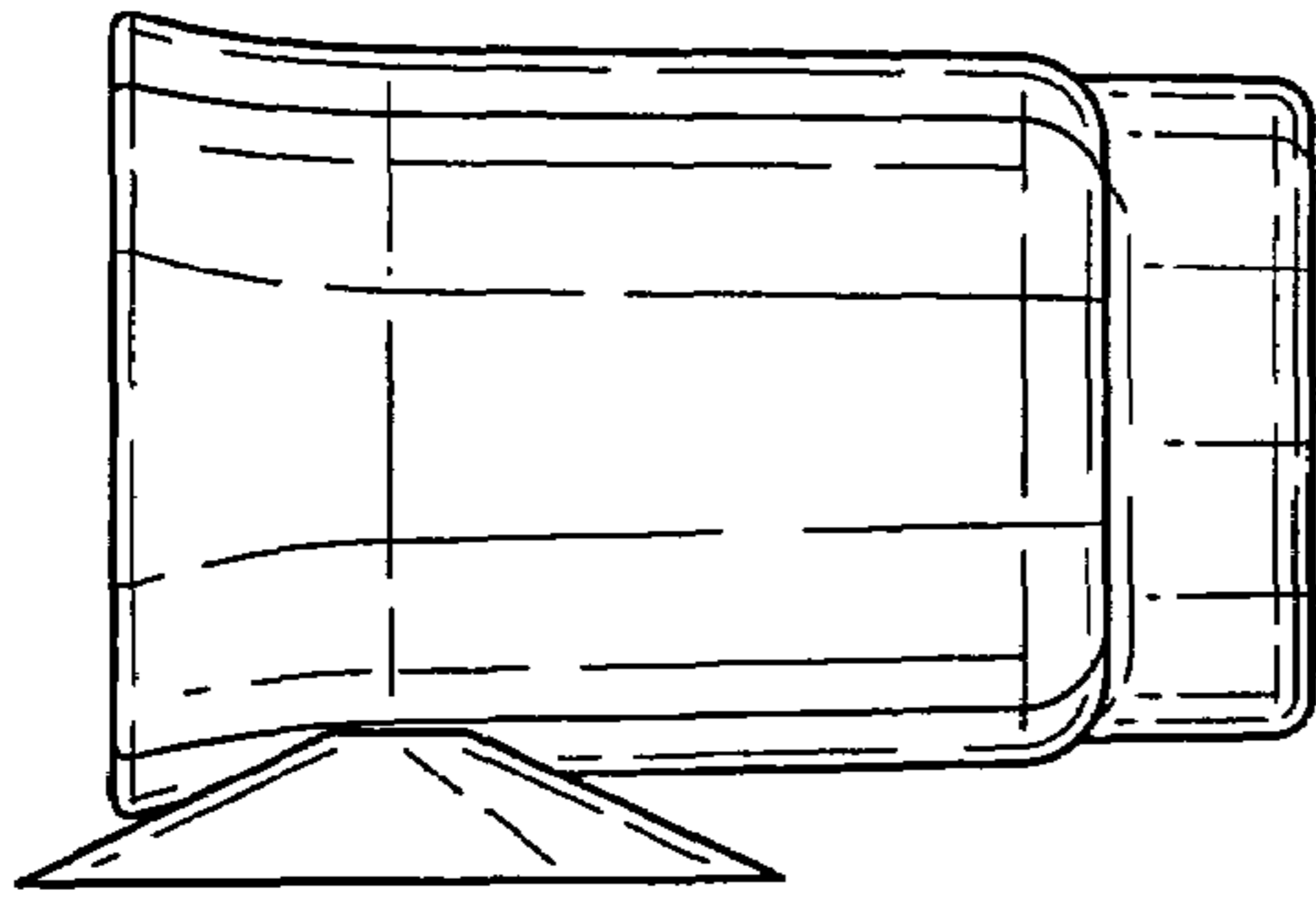

FIG-6

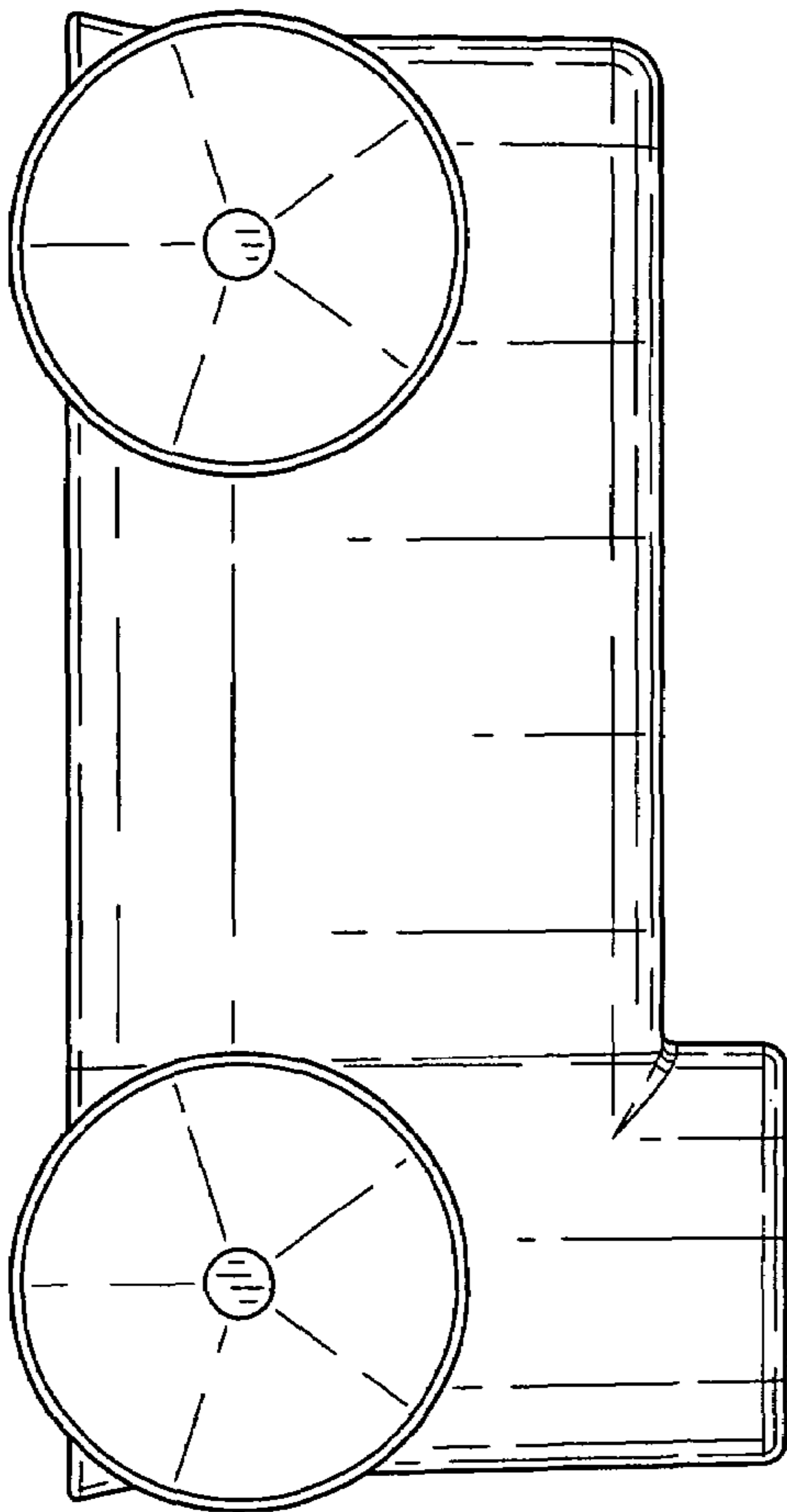

FIG-5

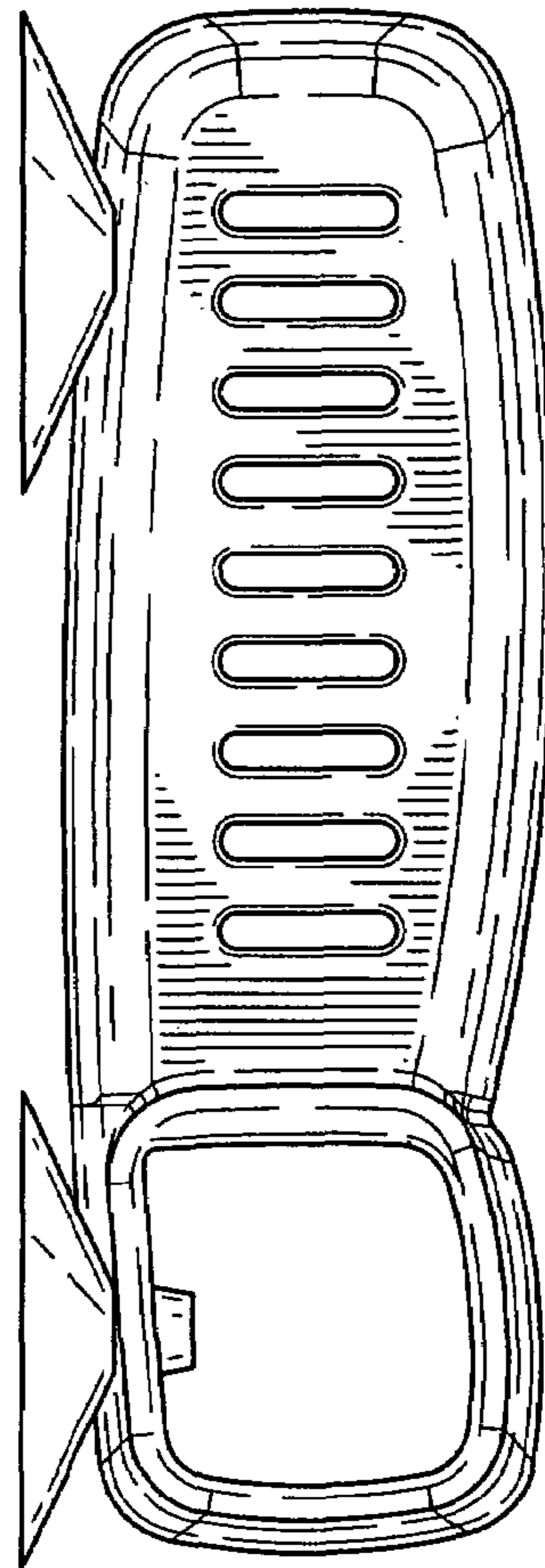

FIG-7