



US00D566768S

(12) **United States Design Patent**
Lau

(10) **Patent No.:** **US D566,768 S**

(45) **Date of Patent:** **** Apr. 15, 2008**

(54) **INTEGRATED TABBED NOTE AND CLIP**

(76) Inventor: **Janet K. Lau**, 1937 Abreu Way, Union City, CA (US) 94587

(**) Term: **14 Years**

(21) Appl. No.: **29/275,390**

(22) Filed: **Dec. 22, 2006**

(51) **LOC (8) Cl.** **19-02**

(52) **U.S. Cl.** **D19/65**

(58) **Field of Classification Search** 24/552,
24/555, 67 R, 67.3, 67.5, 67.7, 67.9, 67.11,
24/545, 546, 547, 551; 40/300, 301, 302,
40/360, 384, 641, 651, 653, 658, 659, 666;
116/236, 237; D6/515; D7/686; D8/16;
D19/1, 2, 5, 6, 34, 65, 86, 90, 91, 99; D20/22,
D20/40, 43

See application file for complete search history.

(56) **References Cited**

U.S. PATENT DOCUMENTS

332,327 A	12/1885	Clark	
863,265 A	8/1907	Crouse	
876,252 A	1/1908	Baker	
962,397 A	6/1910	Whitmore	
1,052,505 A	2/1913	Munger et al.	
1,123,008 A	12/1914	Rice	
1,158,940 A	11/1915	Litt et al.	
1,178,113 A	4/1916	Turton et al.	
D50,594 S	4/1917	Voges	
1,337,607 A *	4/1920	Klenke	24/551
1,345,365 A	7/1920	Hutchison	
1,465,576 A	8/1923	Biggs	
1,501,067 A	7/1924	Schaffert	
1,524,478 A	1/1925	Hunter	
1,543,295 A	6/1925	Parker	
1,587,335 A	6/1926	Kline	
1,661,165 A	3/1928	Cameron	
1,778,031 A	10/1930	Kinch	
1,802,980 A	4/1931	Marsh	
1,826,580 A	10/1931	Spinney	
1,840,604 A	1/1932	Randall	

1,894,906 A	1/1933	Henry	
1,914,671 A	6/1933	O'Neil	
1,976,465 A	10/1934	Thomson	
1,977,096 A	10/1934	Straubel	
1,985,866 A	12/1934	Lankenau	
1,997,894 A	4/1935	Woodley	
2,008,019 A	7/1935	Horlick, Jr.	
D97,328 S	10/1935	Glasser	
2,118,043 A	5/1938	Goza	
2,156,743 A	5/1939	Skrebba	
2,323,552 A	7/1943	Marion	
D136,639 S	11/1943	Hoffman	
2,362,445 A	11/1944	Blodgett	
2,415,248 A	2/1947	Kenna et al.	
2,420,021 A	5/1947	Straubel	
2,478,376 A *	8/1949	De Swart	24/67.9
2,623,311 A	12/1952	Condon	
2,674,972 A	4/1954	Luther	
3,073,046 A	1/1963	Condon	
3,123,924 A	3/1964	Roberts	
3,225,469 A	12/1965	Chase	
3,290,810 A	12/1966	Morena	
3,360,877 A	1/1968	Estep	
D229,571 S	12/1973	Fearing	
3,934,368 A	1/1976	Fearing	
D241,342 S	9/1976	Carroll	
D263,243 S	3/1982	Creamer	
D268,848 S	5/1983	Lorber	
4,384,417 A	5/1983	Thompson	
4,425,724 A	1/1984	Scott	
4,458,386 A *	7/1984	Fernandez	24/67.9
4,646,455 A	3/1987	Gardner	
4,691,458 A	9/1987	Scott	
D305,036 S	12/1989	Voetsch	
4,951,408 A	8/1990	Banks	
D314,012 S	1/1991	Klodt	
5,008,982 A *	4/1991	Tsukamoto	24/67.9
5,067,205 A *	11/1991	Chen et al.	24/67.9
5,199,203 A	4/1993	Jones	
D344,545 S *	2/1994	Tsai	D19/65
5,319,835 A *	6/1994	Chao	24/67.9
D356,116 S *	3/1995	Lorber	D19/65
5,481,784 A	1/1996	Sinaiko	
D368,487 S	4/1996	Lindberg	
4,878,302 A	4/1996	Kiera	
D383,789 S	9/1997	Shyu	
5,695,219 A	12/1997	Crawford	
5,996,130 A	12/1999	Verhines	
D465,525 S	11/2002	Dilday	

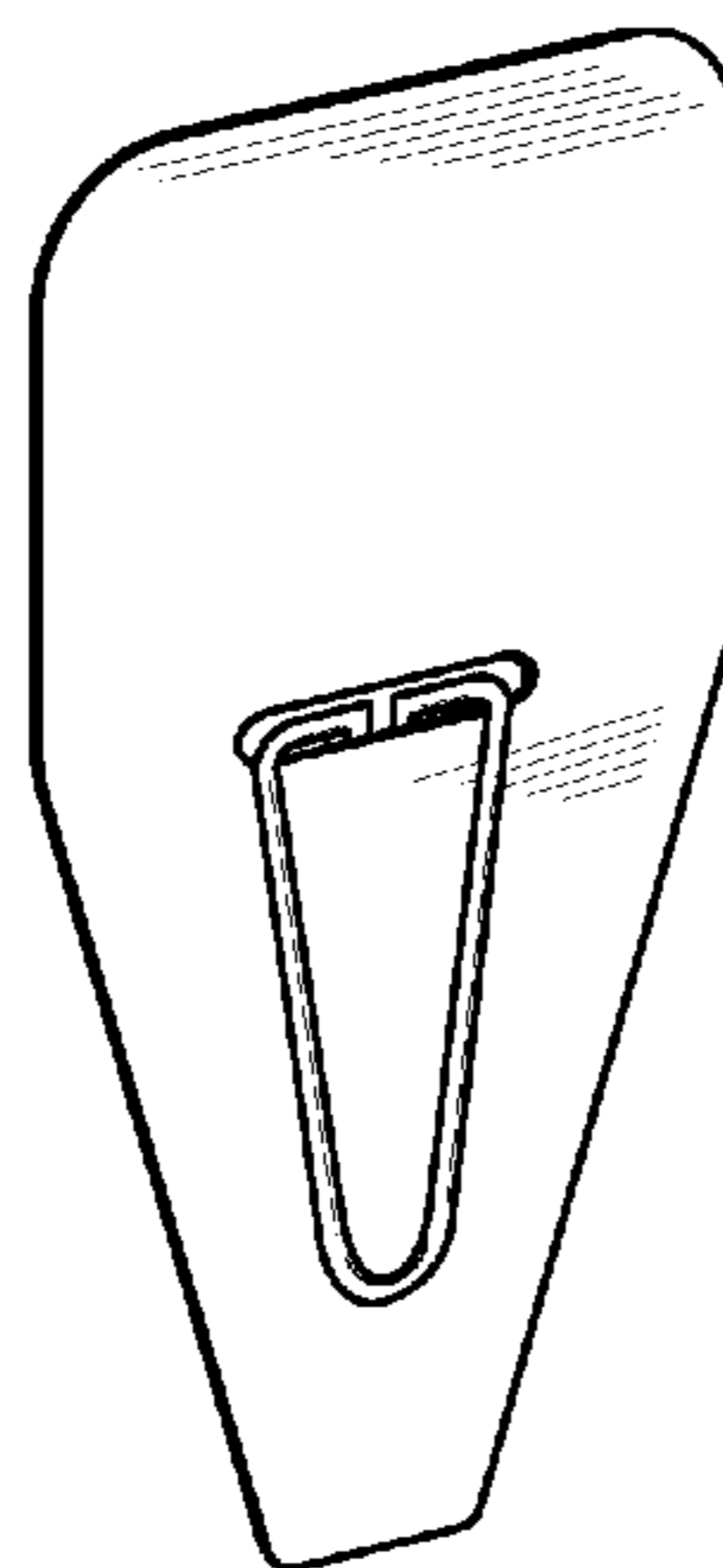

D480,754 S	10/2003	Berger	
D520,065 S	5/2006	Doyle	
D541,346 S *	4/2007	Lau et al.	D19/65
2005/0217078 A1	10/2005	Groch et al.	
2006/0000133 A1	1/2006	Windorski	

FOREIGN PATENT DOCUMENTS

JP	09-071065 A	3/1997
JP	2001-353992 A	12/2001

* cited by examiner

Primary Examiner—Cathron C. Brooks
Assistant Examiner—Austin Murphy
 (74) *Attorney, Agent, or Firm*—Aka Chan LLP

(57) **CLAIM**

The ornamental design for an integrated tabbed note and clip, as shown and described.

DESCRIPTION

FIG. 1 shows a perspective view of a first embodiment of a design for an integrated tabbed note and clip.

FIG. 2 shows a front view of the first embodiment.

FIG. 3 shows a right-side view of the first embodiment. A left-side view of this embodiment is a mirror image of this figure.

FIG. 4 shows a back view of the first embodiment.

FIG. 5 shows a top view of the first embodiment.

FIG. 6 shows a bottom view of the first embodiment.

FIG. 7 shows a perspective view of a second embodiment.

FIG. 8 shows a front view of the second embodiment.

FIG. 9 shows a right-side view of the second embodiment. A left-side view of this embodiment is a mirror image of this figure.

FIG. 10 shows a back view of the second embodiment.

FIG. 11 shows a top view of the second embodiment.

FIG. 12 shows a bottom view of the second embodiment.

FIG. 13 shows a perspective view of a third embodiment.

FIG. 14 shows a front view of the third embodiment.

FIG. 15 shows a right-side view of the third embodiment. A left-side view of this embodiment is a mirror image of this figure.

FIG. 16 shows a back view of the third embodiment.

FIG. 17 shows a top view of the third embodiment.

FIG. 18 shows a bottom view of the third embodiment.

FIG. 19 shows a perspective view of a fourth embodiment.

FIG. 20 shows a front view of the fourth embodiment.

FIG. 21 shows a right-side view of the fourth embodiment. A left-side view of this embodiment is a mirror image of this figure.

FIG. 22 shows a back view of the fourth embodiment.

FIG. 23 shows a top view of the fourth embodiment.

FIG. 24 shows a bottom view of the fourth embodiment.

FIG. 25 shows a perspective view of a fifth embodiment.

FIG. 26 shows a front view of the fifth embodiment.

FIG. 27 shows a right-side view of the fifth embodiment. A left-side view of this embodiment is a mirror image of this figure.

FIG. 28 shows a back view of the fifth embodiment.

FIG. 29 shows a top view of the fifth embodiment.

FIG. 30 shows a bottom view of the fifth embodiment.

FIG. 31 shows a perspective view of a sixth embodiment.

FIG. 32 shows a front view of the sixth embodiment.

FIG. 33 shows a right-side view of the sixth embodiment. A left-side view of this embodiment is a mirror image of this figure.

FIG. 34 shows a back view of the sixth embodiment.

FIG. 35 shows a top view of the sixth embodiment; and,

FIG. 36 shows a bottom view of the sixth embodiment.

1 Claim, 6 Drawing Sheets

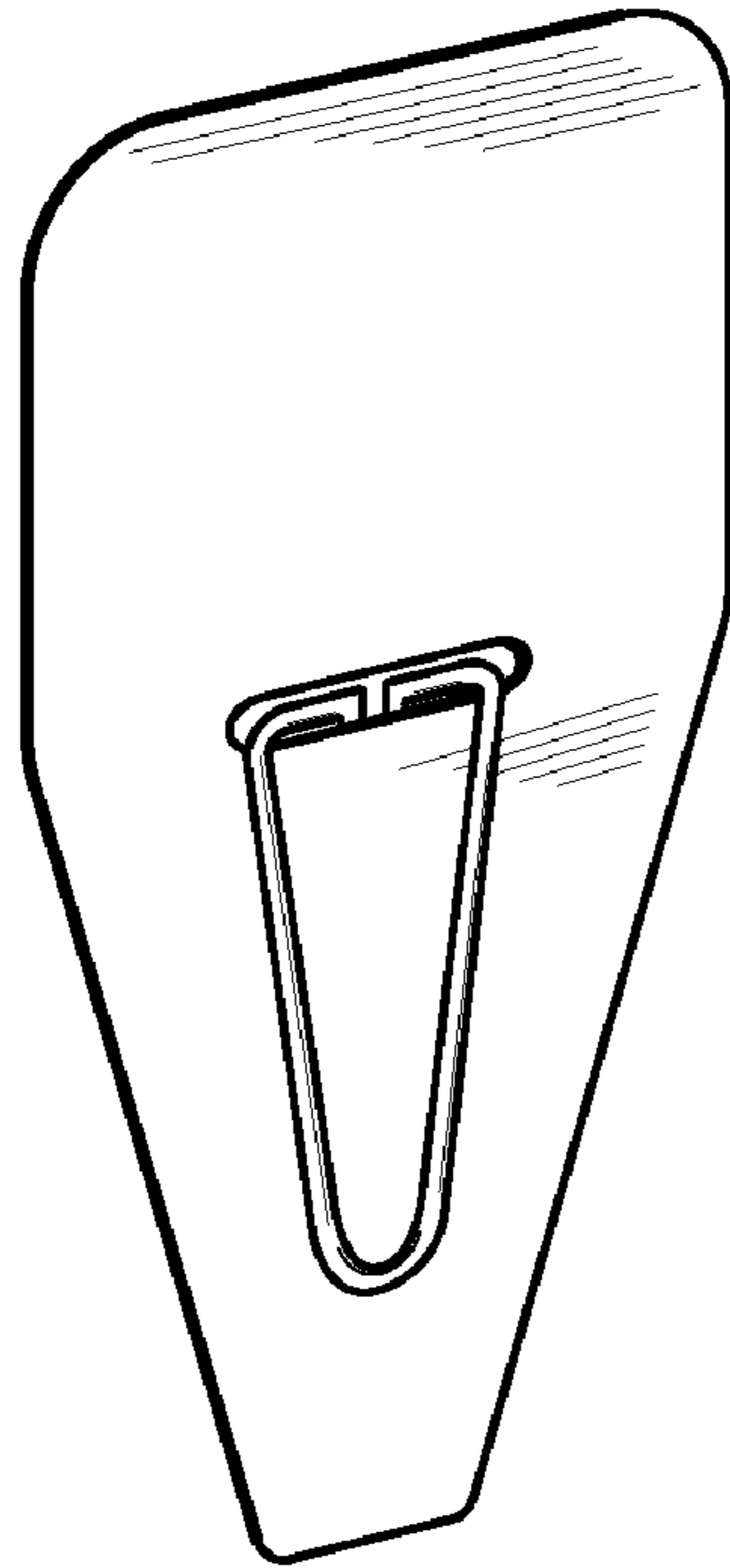

FIG. 1



FIG. 5



FIG. 6

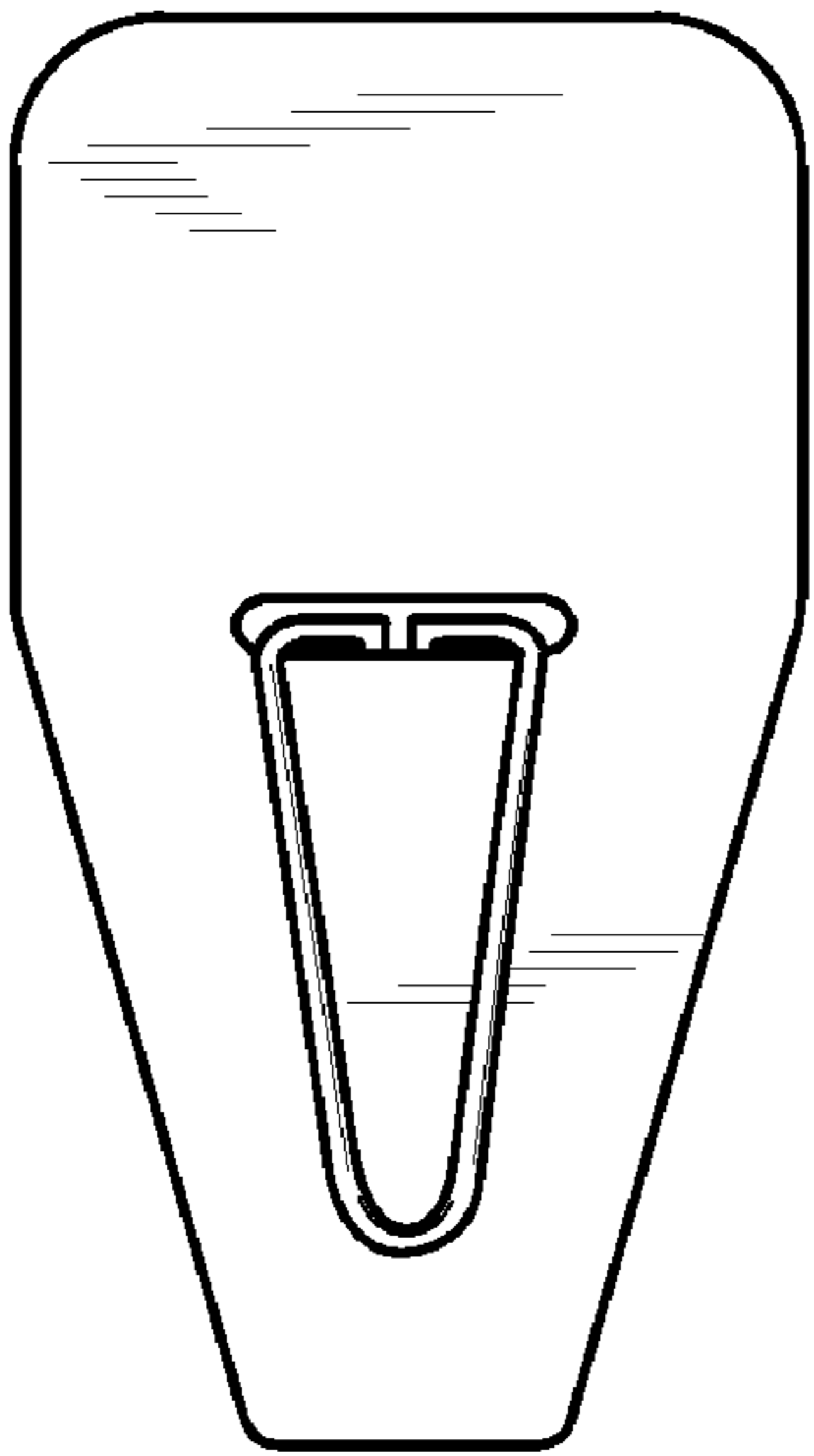

FIG. 2



FIG. 3

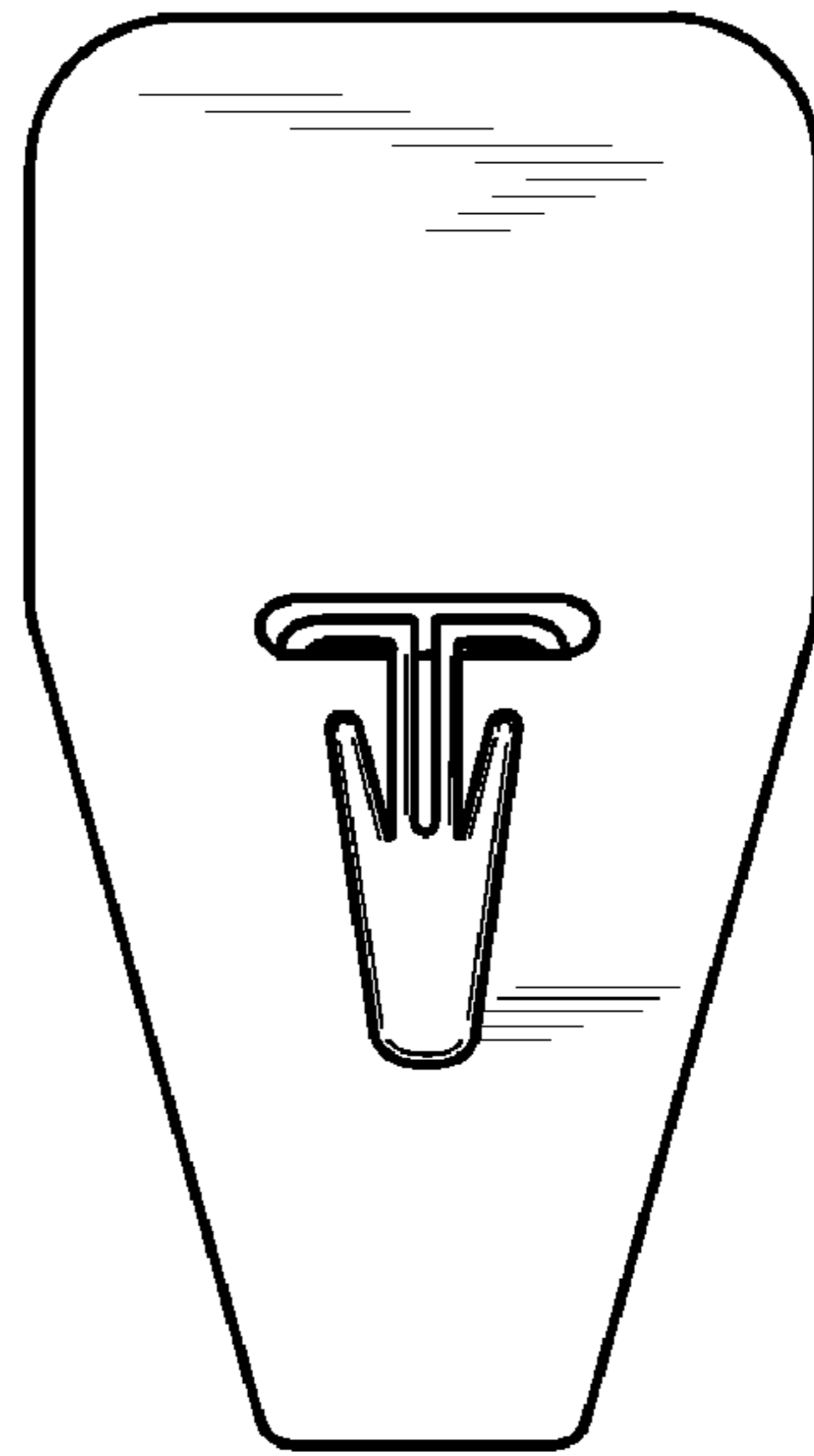

FIG. 4

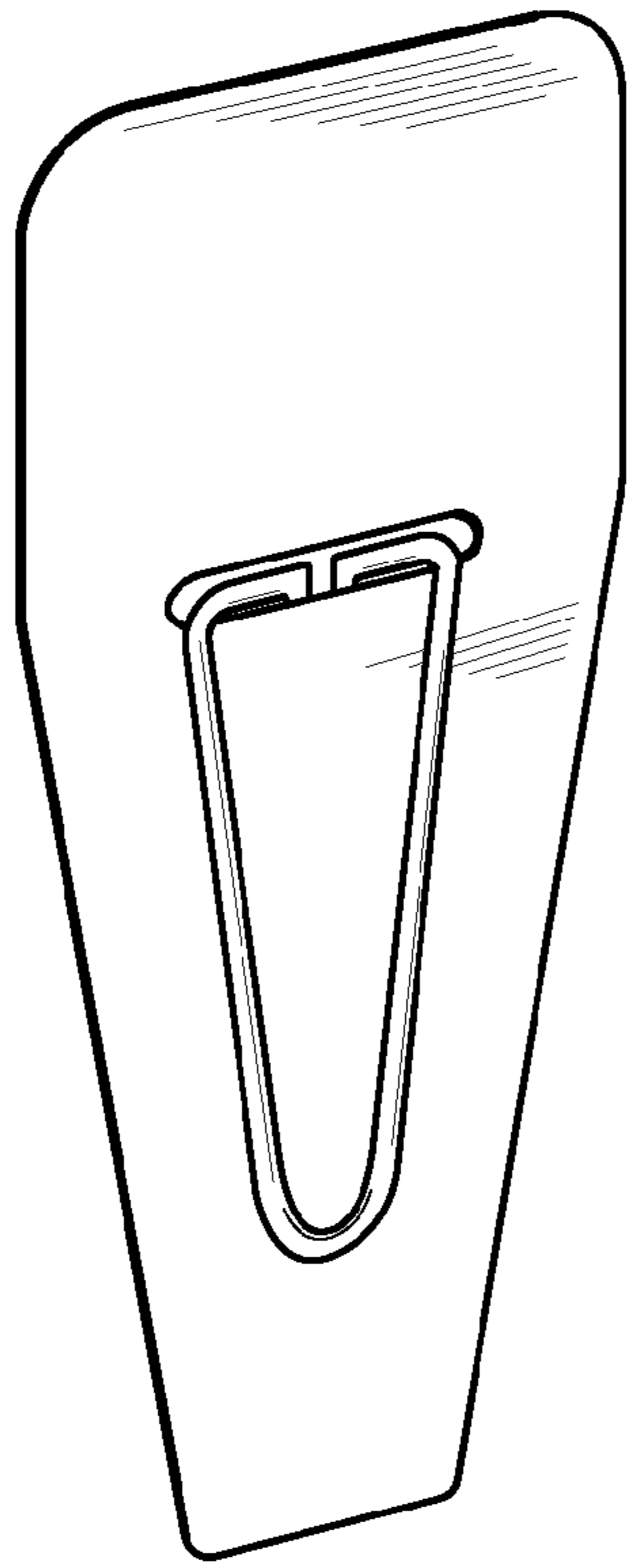

FIG. 7



FIG. 11



FIG. 12

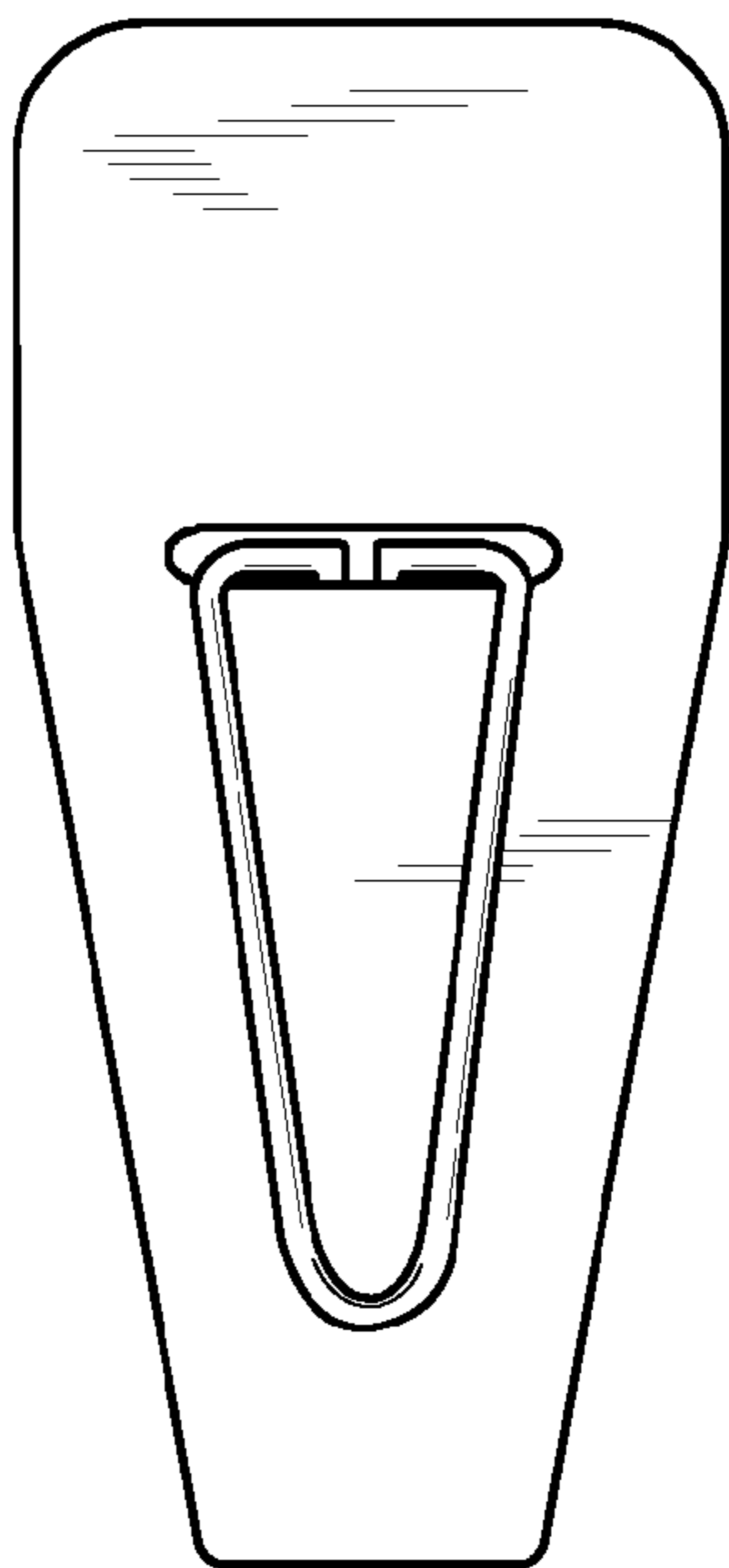

FIG. 8



FIG. 9

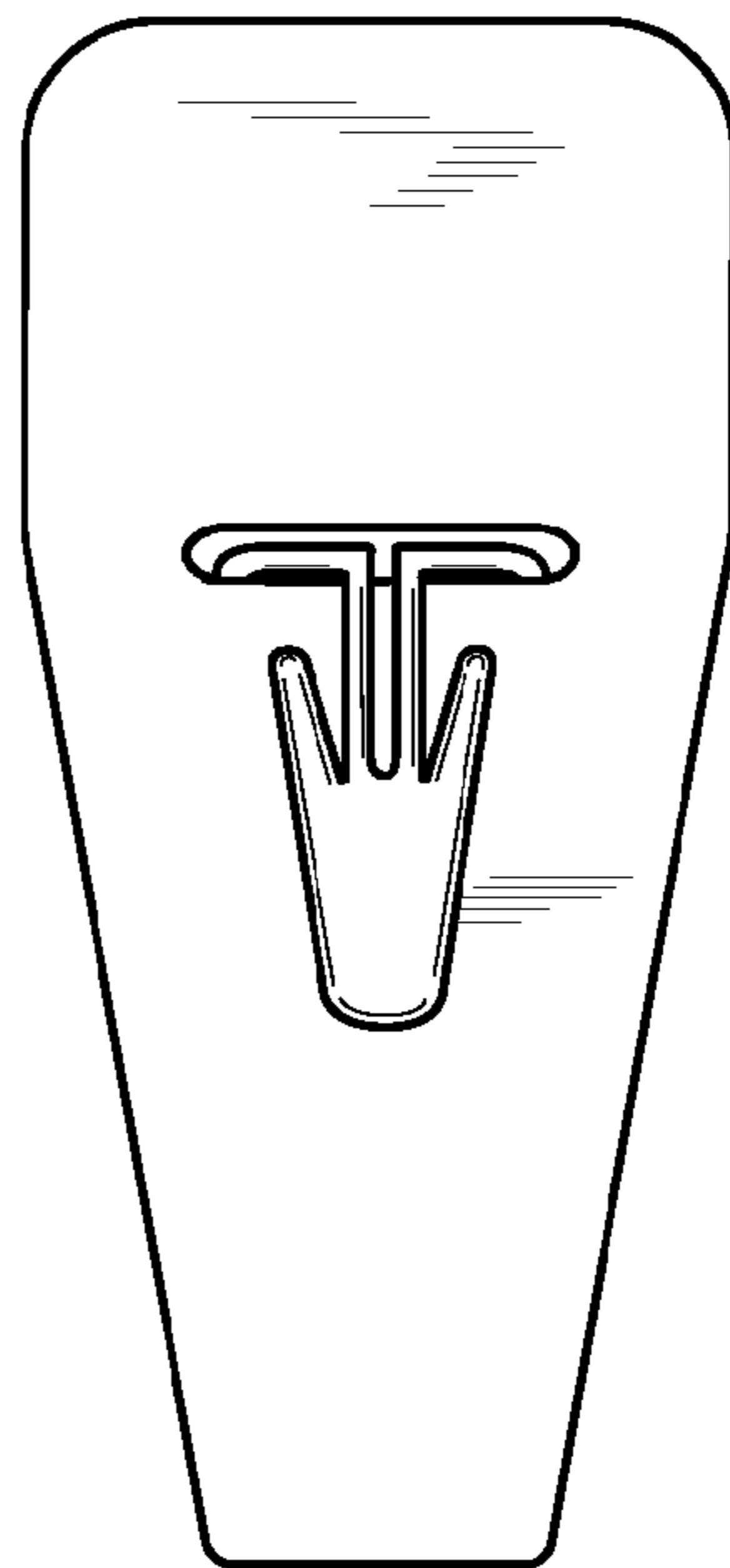

FIG. 10

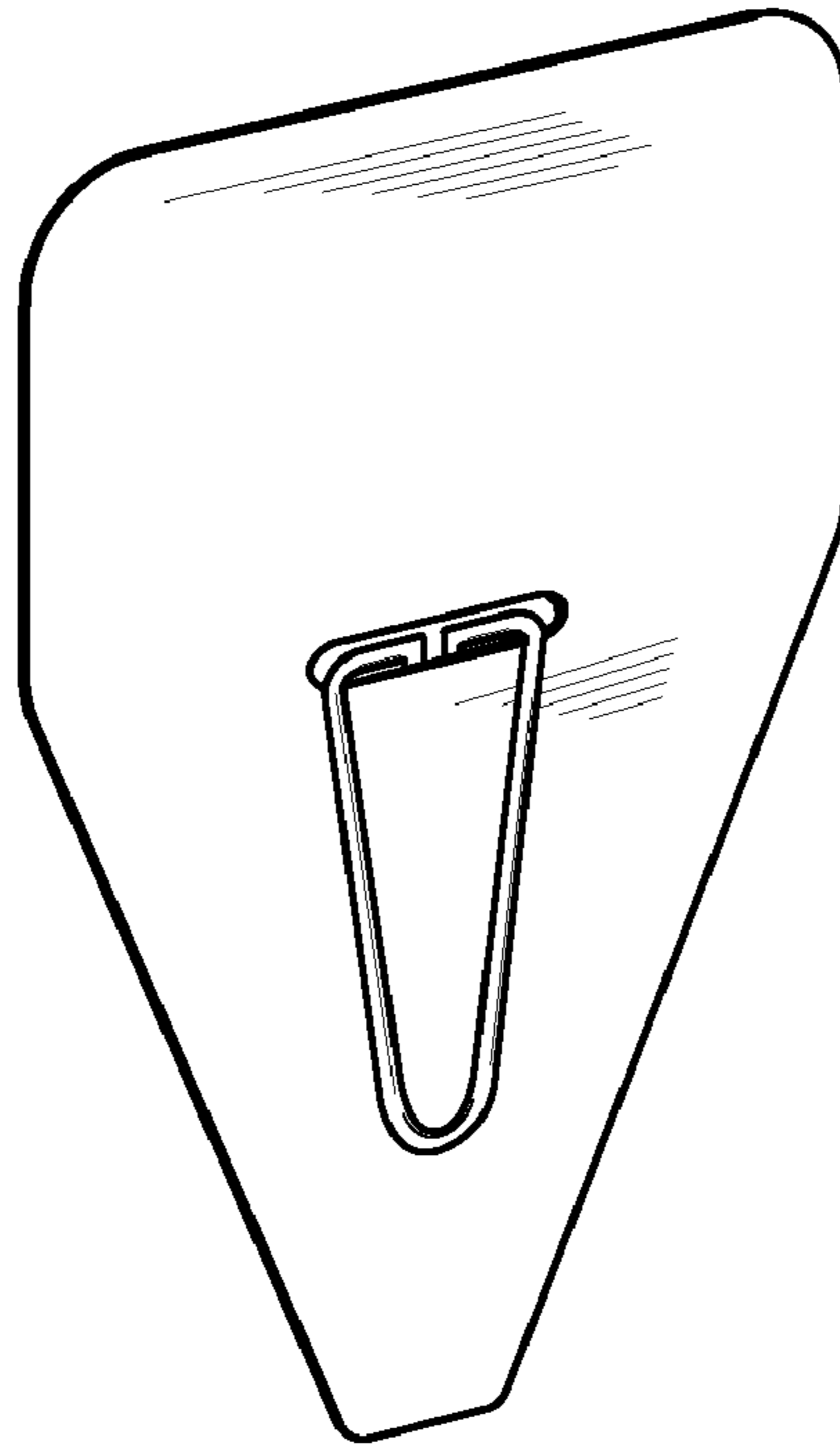

FIG. 13



FIG. 17



FIG. 18

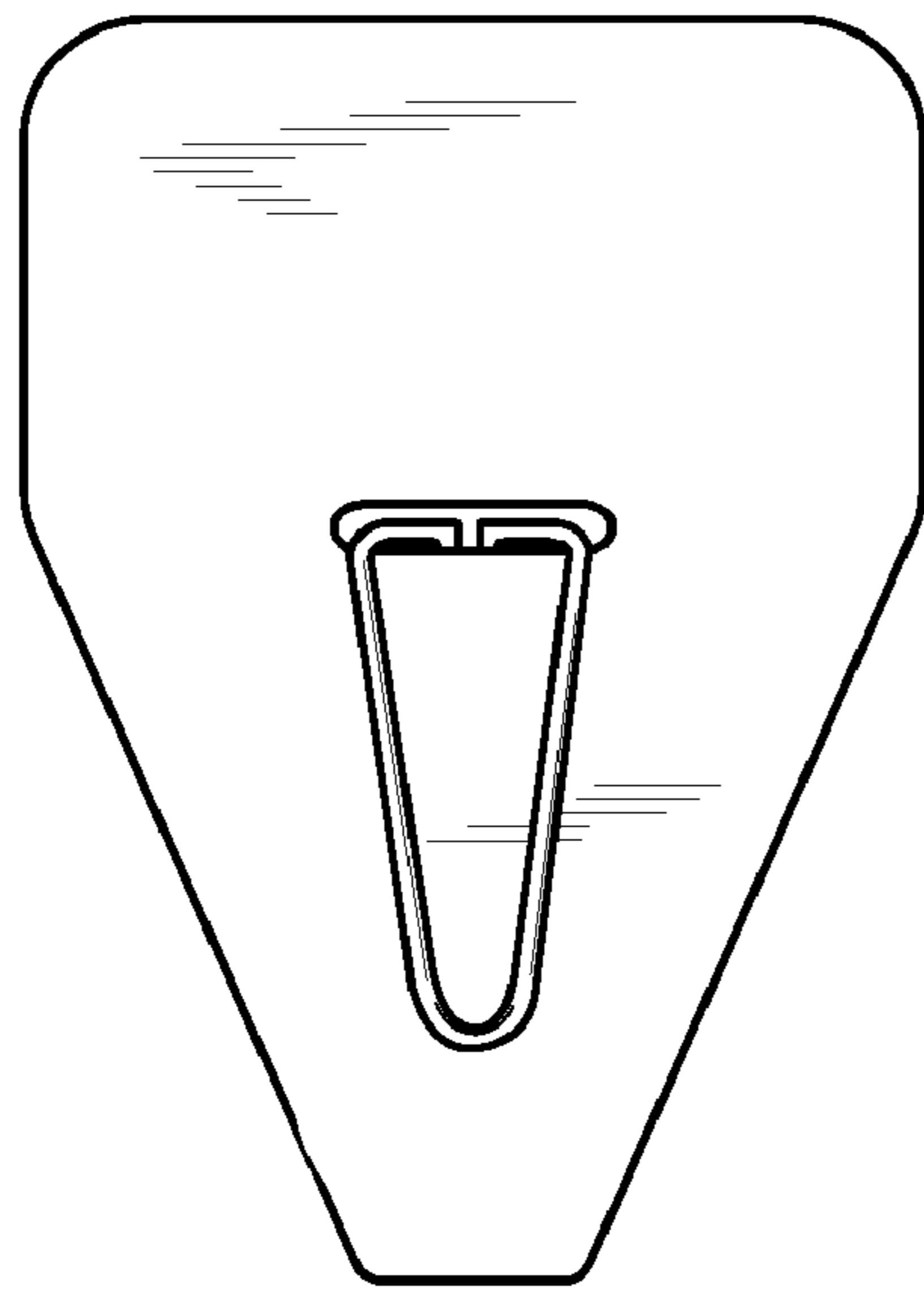

FIG. 14



FIG. 15

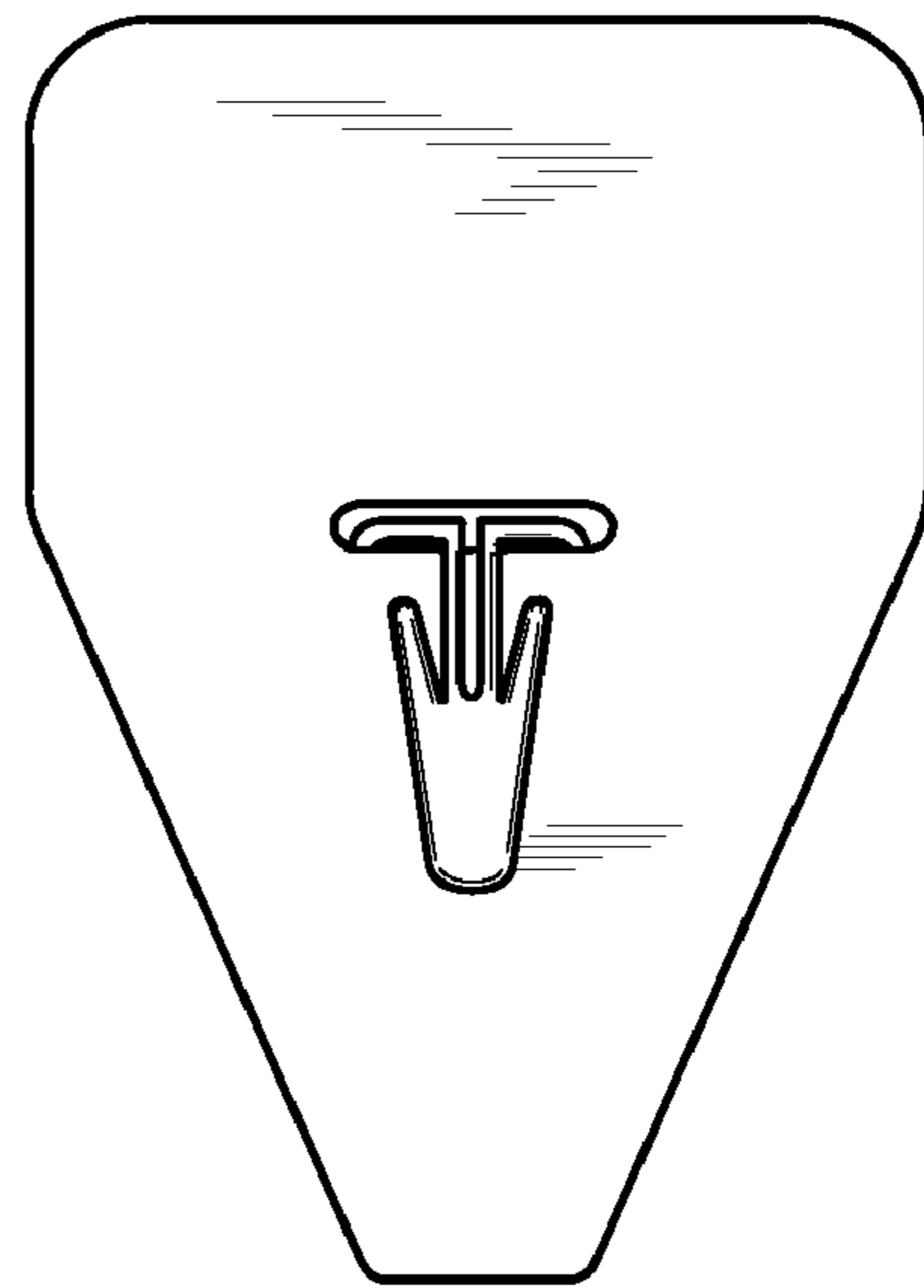

FIG. 16

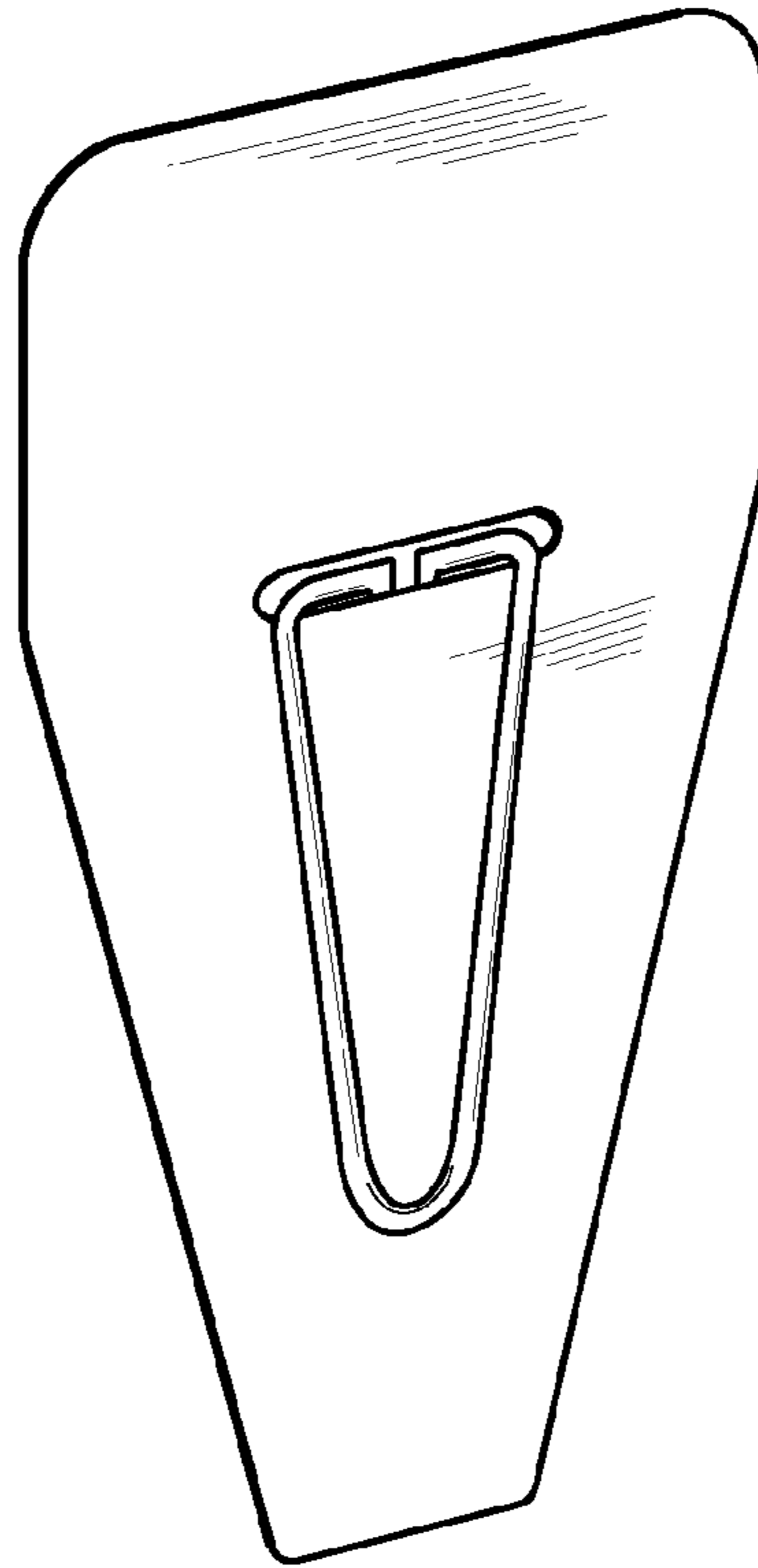

FIG. 19



FIG. 23



FIG. 24

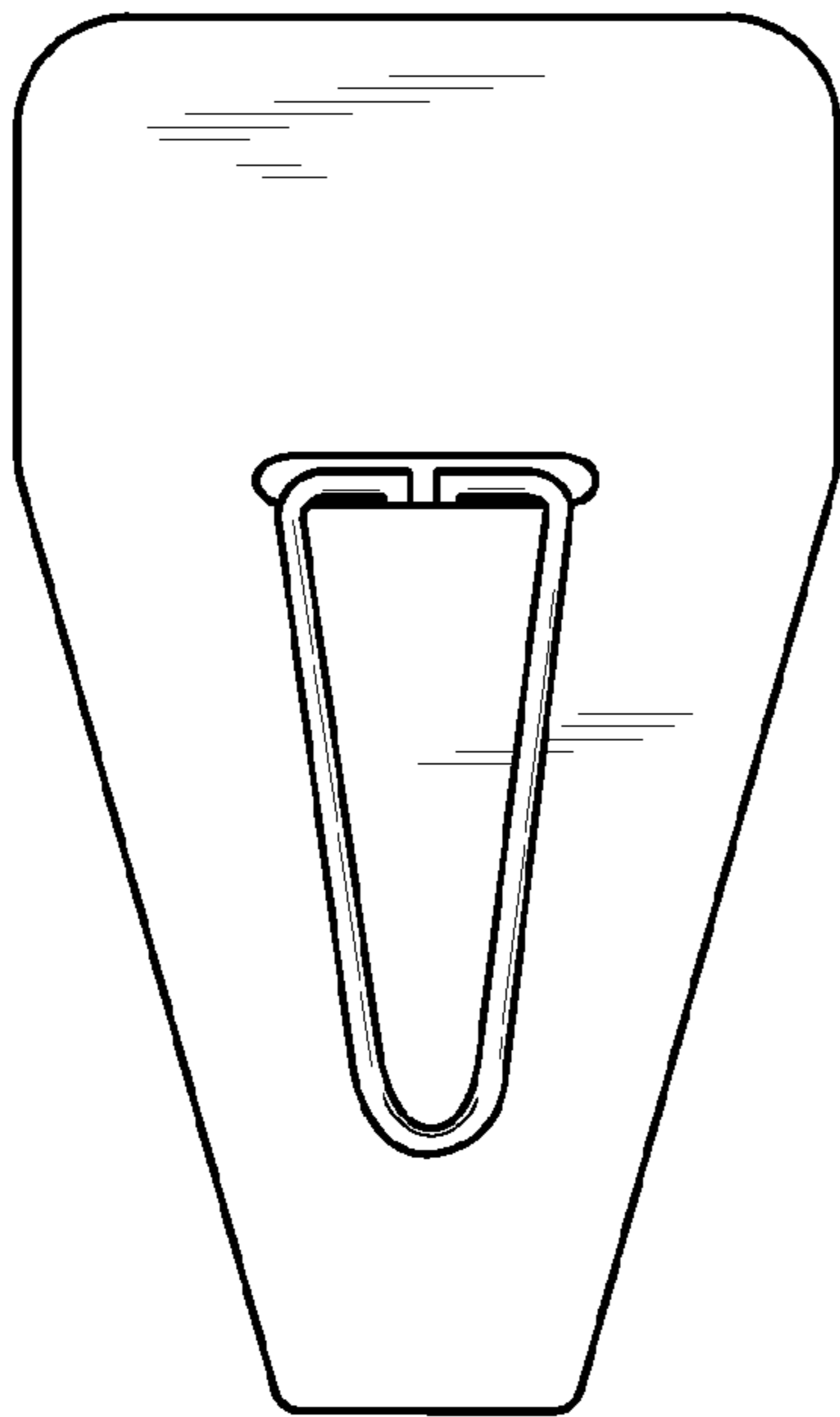

FIG. 20



FIG. 21

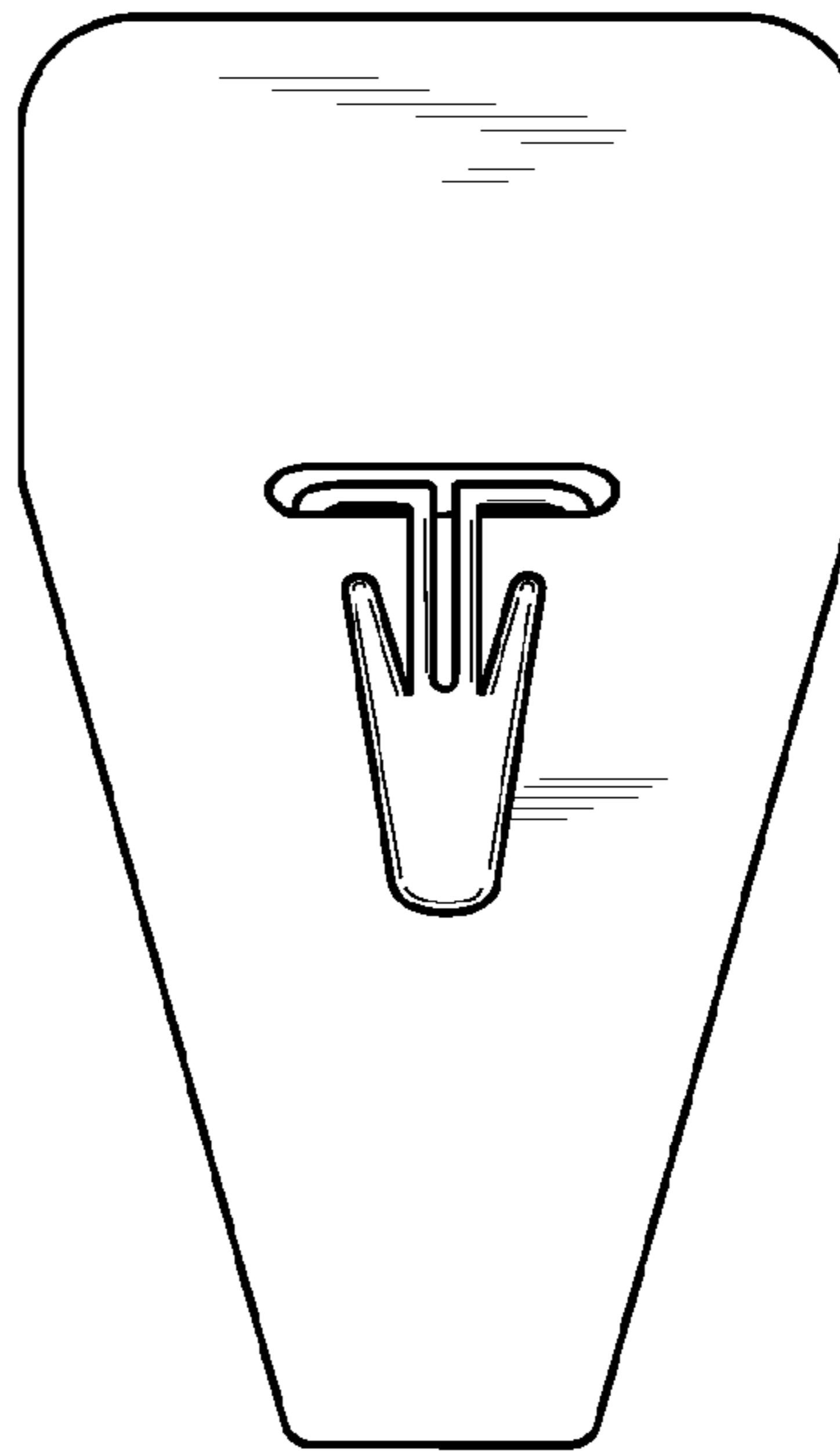

FIG. 22

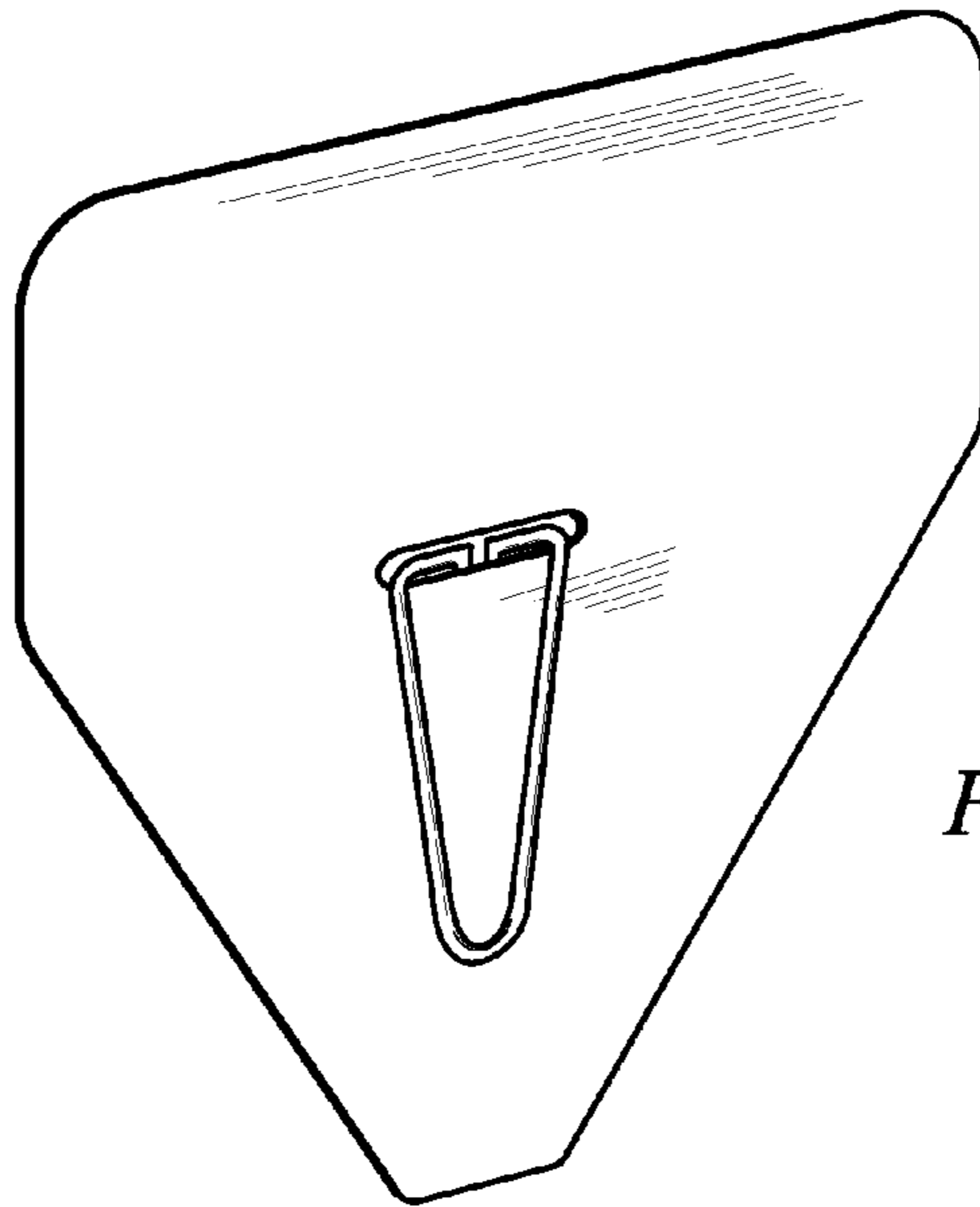

FIG. 25



FIG. 29



FIG. 30

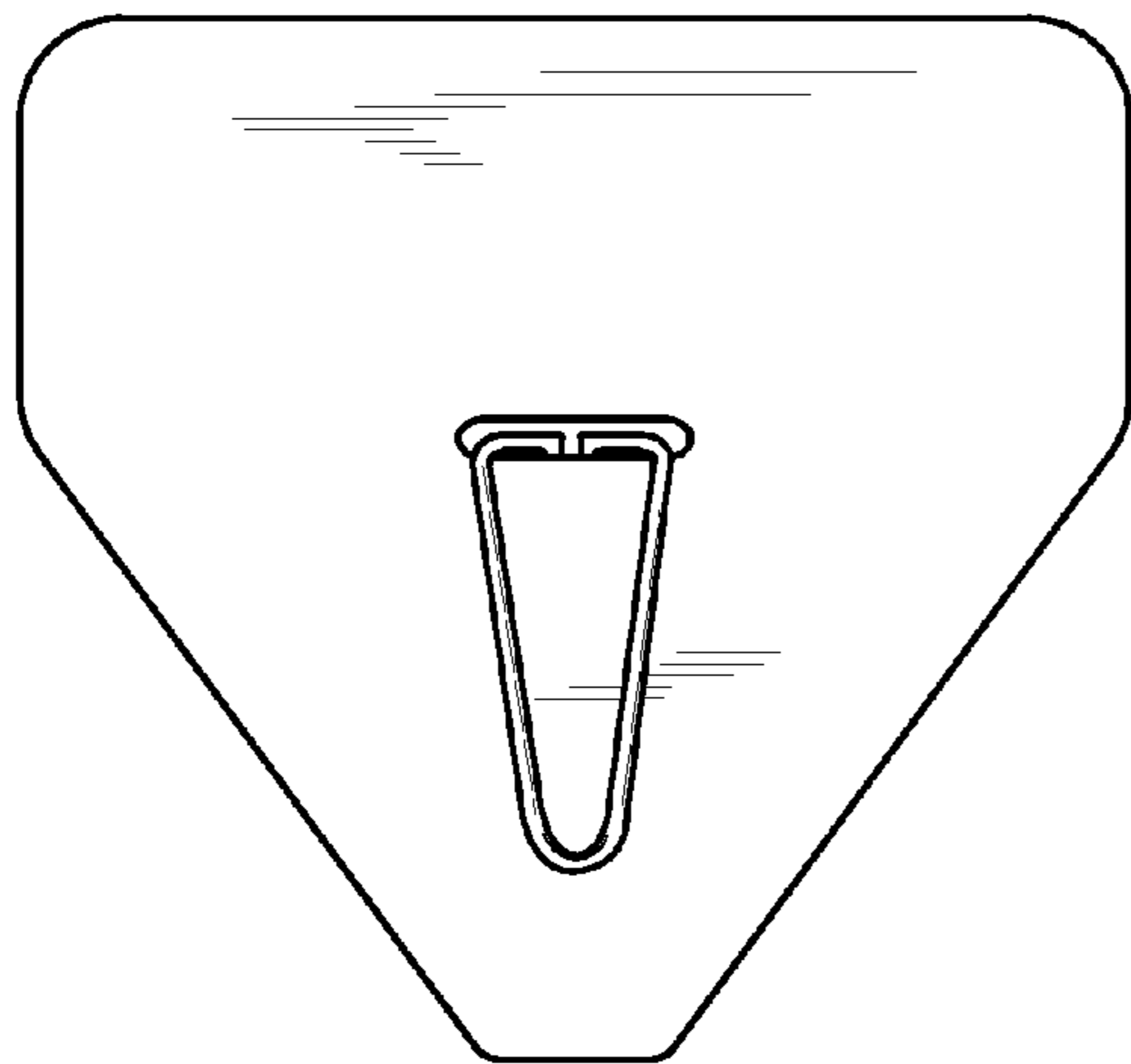

FIG. 26



FIG. 27

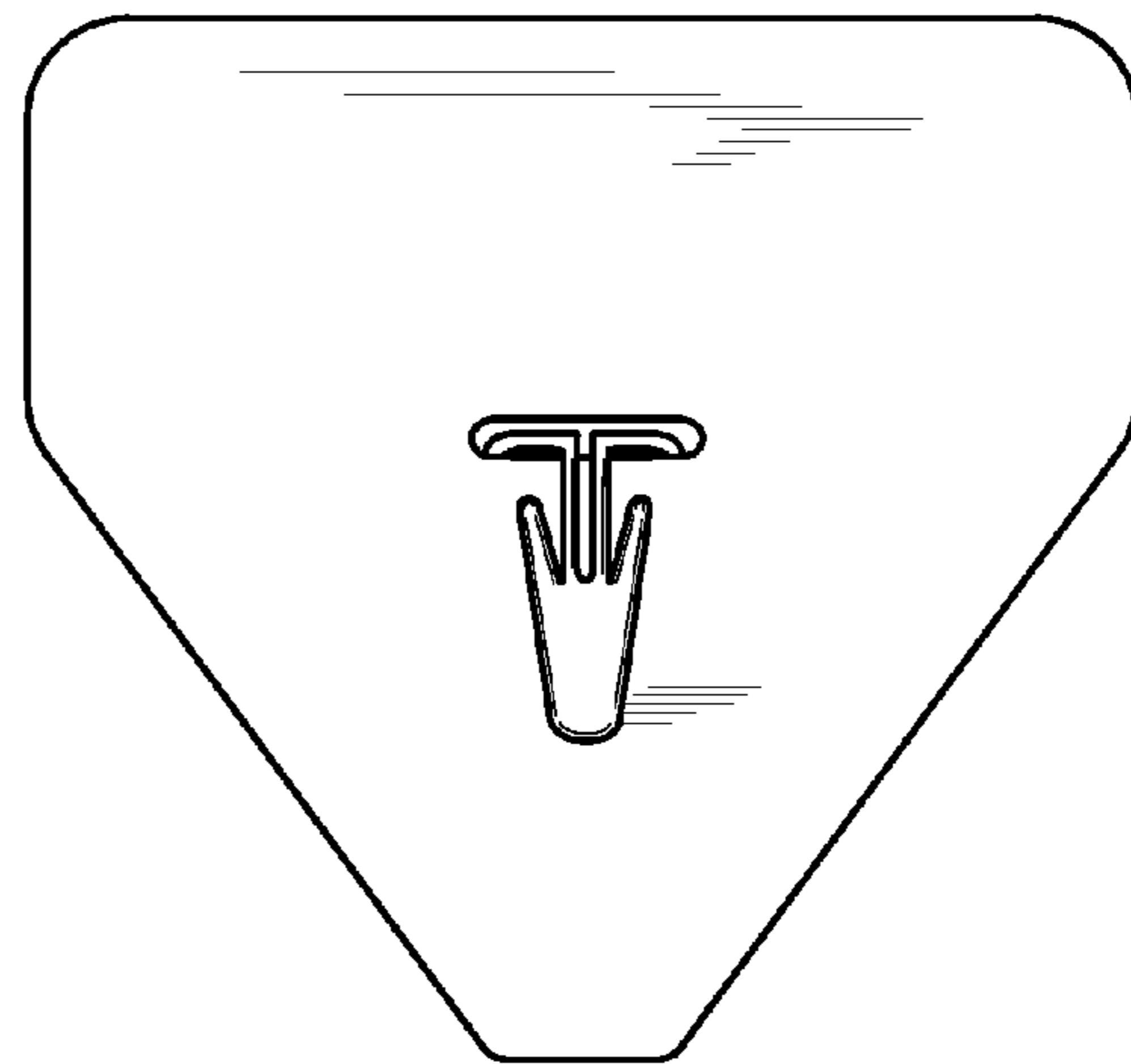

FIG. 28

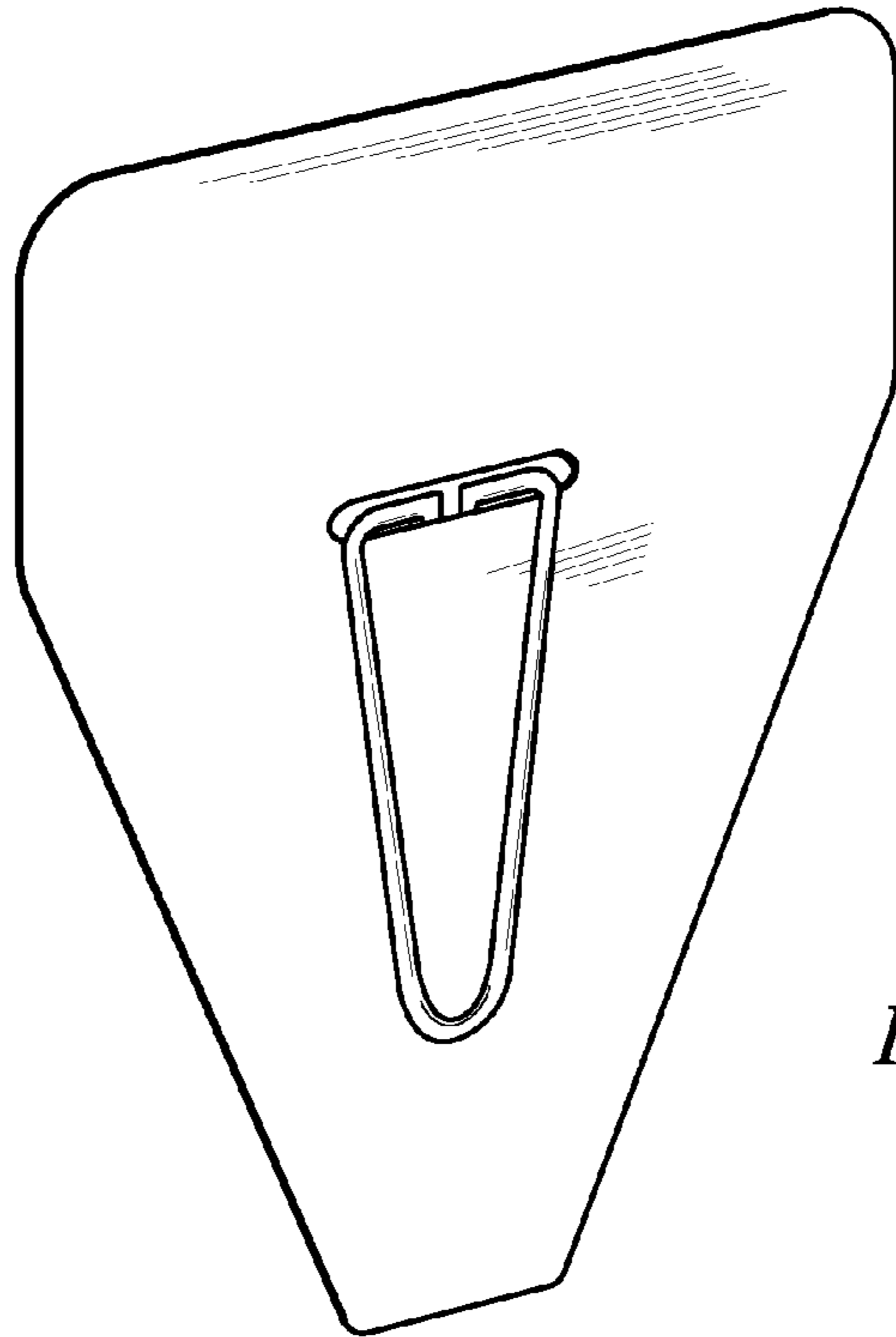

FIG. 31



FIG. 35



FIG. 36

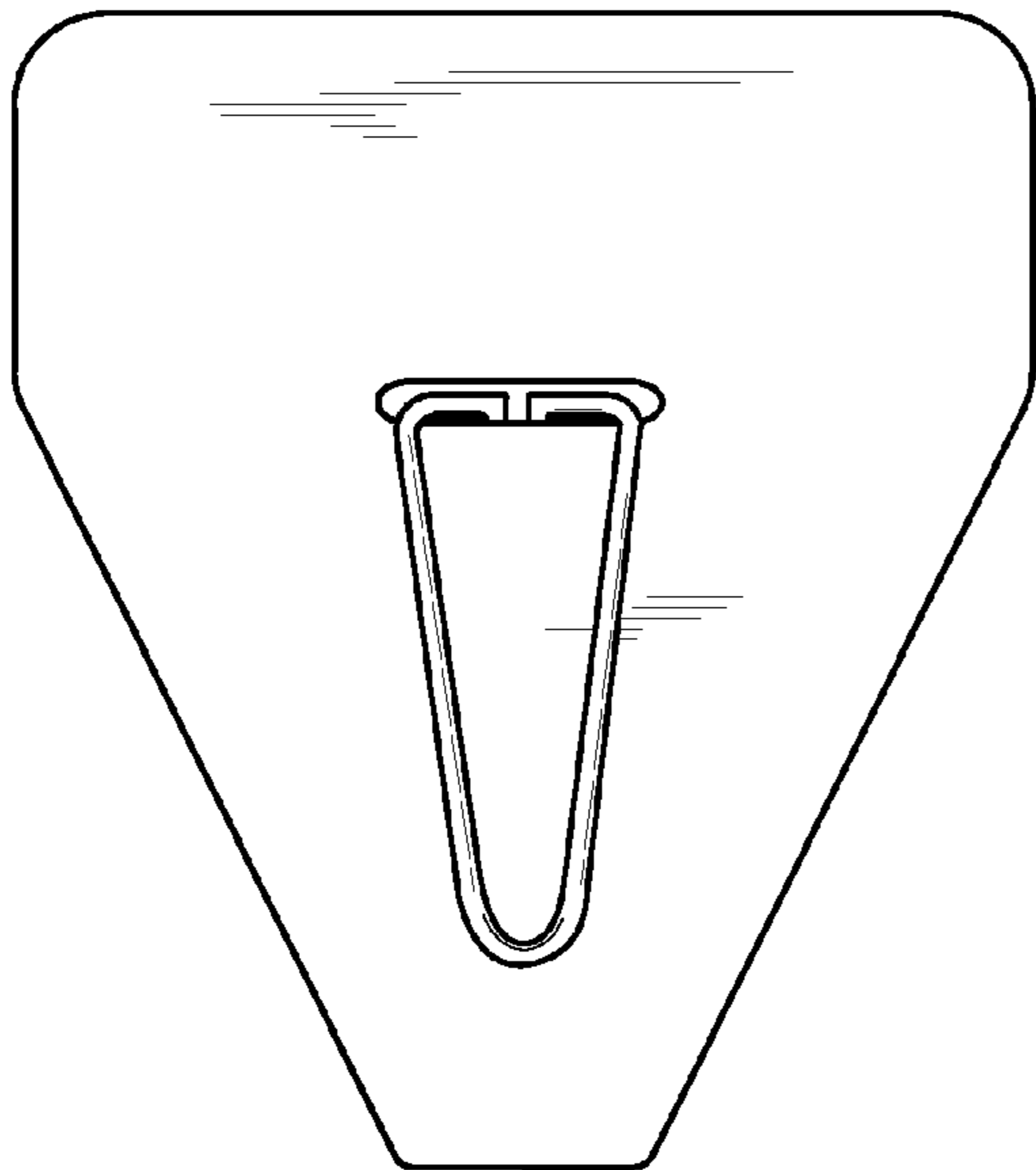

FIG. 32



FIG. 33

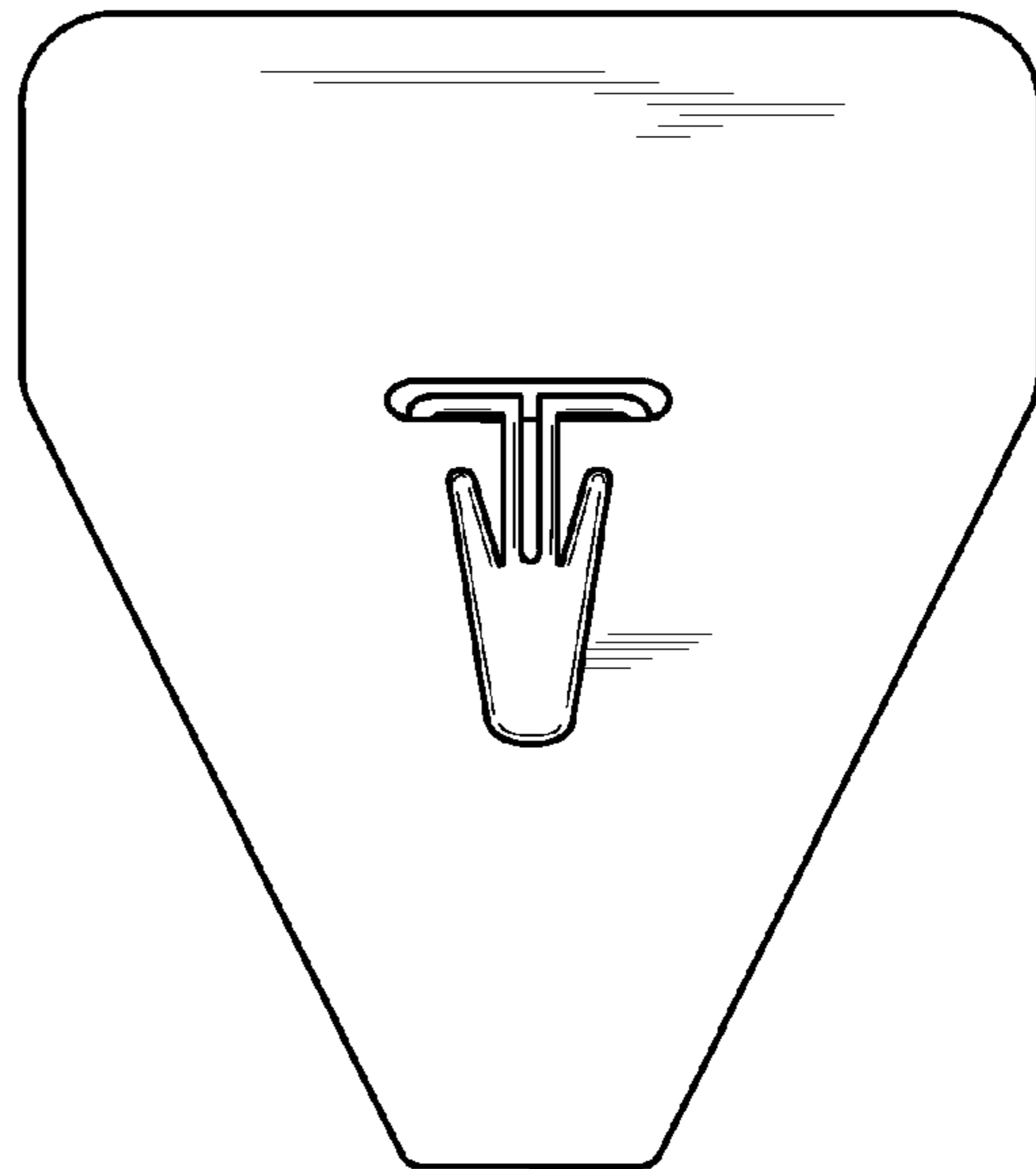

FIG. 34