



US00D566615S

(12) **United States Design Patent** (10) **Patent No.:** **US D566,615 S**  
**Vogt** (45) **Date of Patent:** **\*\* Apr. 15, 2008**

(54) **ROTATIONAL PLANT BASKET HANGER**

**DESCRIPTION**

(76) Inventor: **Paul Andrew Vogt**, 1058 Ottawa, West St. Paul, MN (US) 55118

(\*\*) Term: **14 Years**

(21) Appl. No.: **29/258,701**

(22) Filed: **Apr. 27, 2006**

(51) **LOC (8) Cl.** ..... **11-02**

(52) **U.S. Cl.** ..... **D11/148**

(58) **Field of Classification Search** ..... D6/556-558;  
D7/516, 517, 520, 562; D11/142-156; D19/75,  
D19/77, 80-82, 84; D26/9, 16; 47/33, 39,  
47/41.01, 41.1, 41.11-41.13, 41.15, 65.5,  
47/66.1, 66.6, 66.7, 67-71  
See application file for complete search history.

(56) **References Cited**

**U.S. PATENT DOCUMENTS**

D274,583	S *	7/1984	Lafferty	.....	D11/148
D283,992	S *	5/1986	Tendrup et al.	.....	D11/148
4,744,171	A *	5/1988	Hilliard	.....	47/67
5,159,780	A *	11/1992	Molthen	.....	47/70
5,779,210	A *	7/1998	Canson et al.	.....	47/67
D436,840	S *	1/2001	Vogt	.....	D8/373
6,536,160	B1 *	3/2003	Morlier et al.	.....	47/66.7
2005/0077445	A1 *	4/2005	Vogt	.....	47/67
2006/0059776	A1 *	3/2006	Luken et al.	.....	47/67
2006/0273230	A1 *	12/2006	Logan et al.	.....	47/67

\* cited by examiner

*Primary Examiner*—Joel Sincavage  
*Assistant Examiner*—Garth Rademaker

(57) **CLAIM**

The ornamental design for rotational plant basket hanger, as shown and described.

FIG. 1 is a perspective view of a rotational plant basket hanger, showing my new design;

FIG. 2 is a perspective view thereof, shown disassembled;

FIG. 3 is a top plan view thereof;

FIG. 4 is a bottom plan view thereof;

FIG. 5 is a top plan view thereof, shown disassembled; and

FIG. 6 is a bottom plan view thereof, shown disassembled.

FIG. 7 is a perspective view of a second embodiment of a rotational plant basket hanger;

FIG. 8 is a perspective view thereof, shown disassembled;

FIG. 9 is a top plan view thereof;

FIG. 10 is a bottom plan view thereof;

FIG. 11 is a top plan view thereof, shown disassembled; and

FIG. 12 is a bottom plan view thereof, shown disassembled.

FIG. 13 is a perspective view of a third embodiment of a rotational plant basket hanger;

FIG. 14 is a perspective view thereof, shown disassembled;

FIG. 15 is a top plan view thereof;

FIG. 16 is a bottom plan view thereof;

FIG. 17 is a top plan view thereof, shown disassembled; and

FIG. 18 is a bottom plan view thereof, shown disassembled.

FIG. 19 is a perspective view of a fourth embodiment of a rotational plant basket hanger;

FIG. 20 is a perspective view thereof, shown disassembled;

FIG. 21 is a top plan view thereof;

FIG. 22 is a bottom plan view thereof;

FIG. 23 is a top plan view thereof, shown disassembled; and

FIG. 24 is a bottom plan view thereof, shown disassembled.

FIG. 25 is a perspective view of a fifth embodiment of a rotational plant basket hanger;

FIG. 26 is a perspective view thereof, shown disassembled;

FIG. 27 is a top plan view thereof;

FIG. 28 is a bottom plan view thereof;

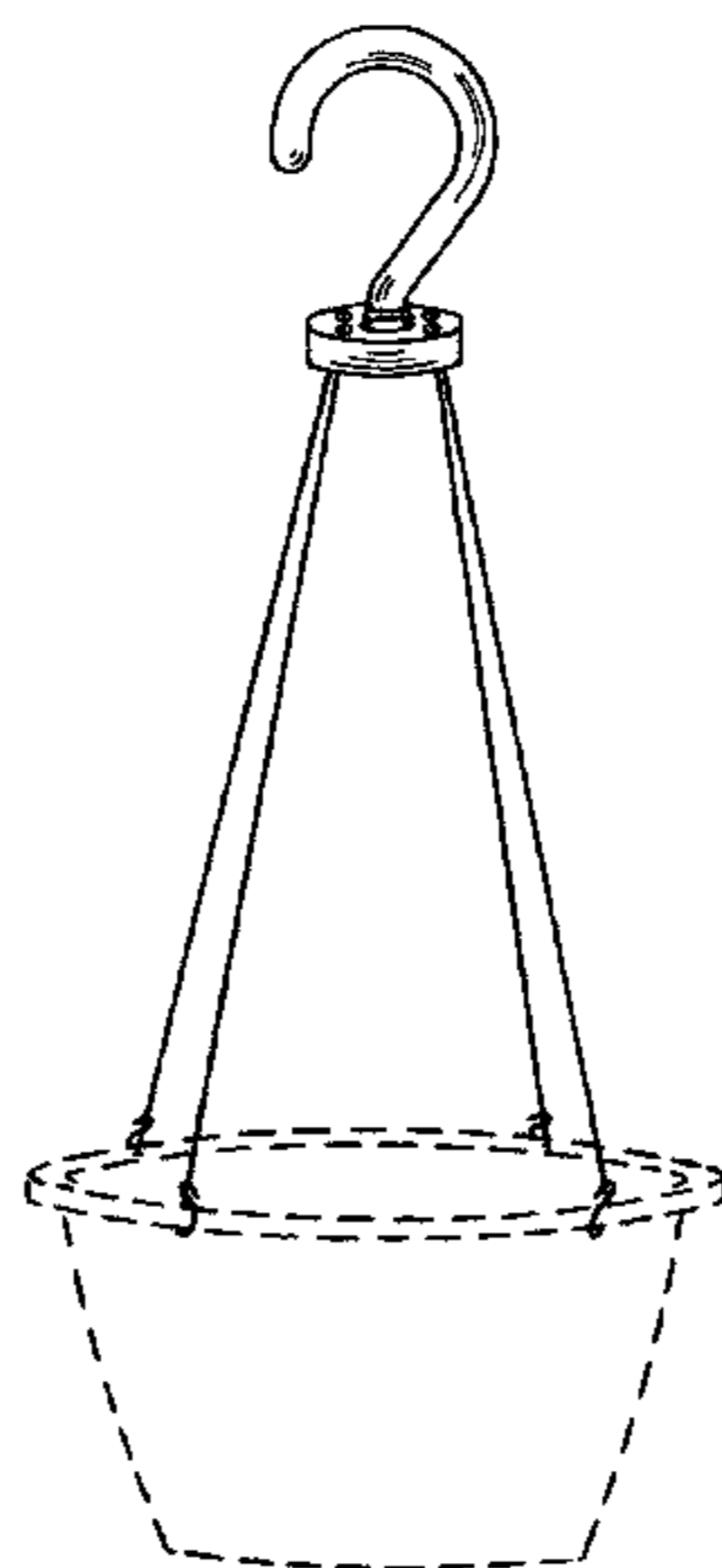


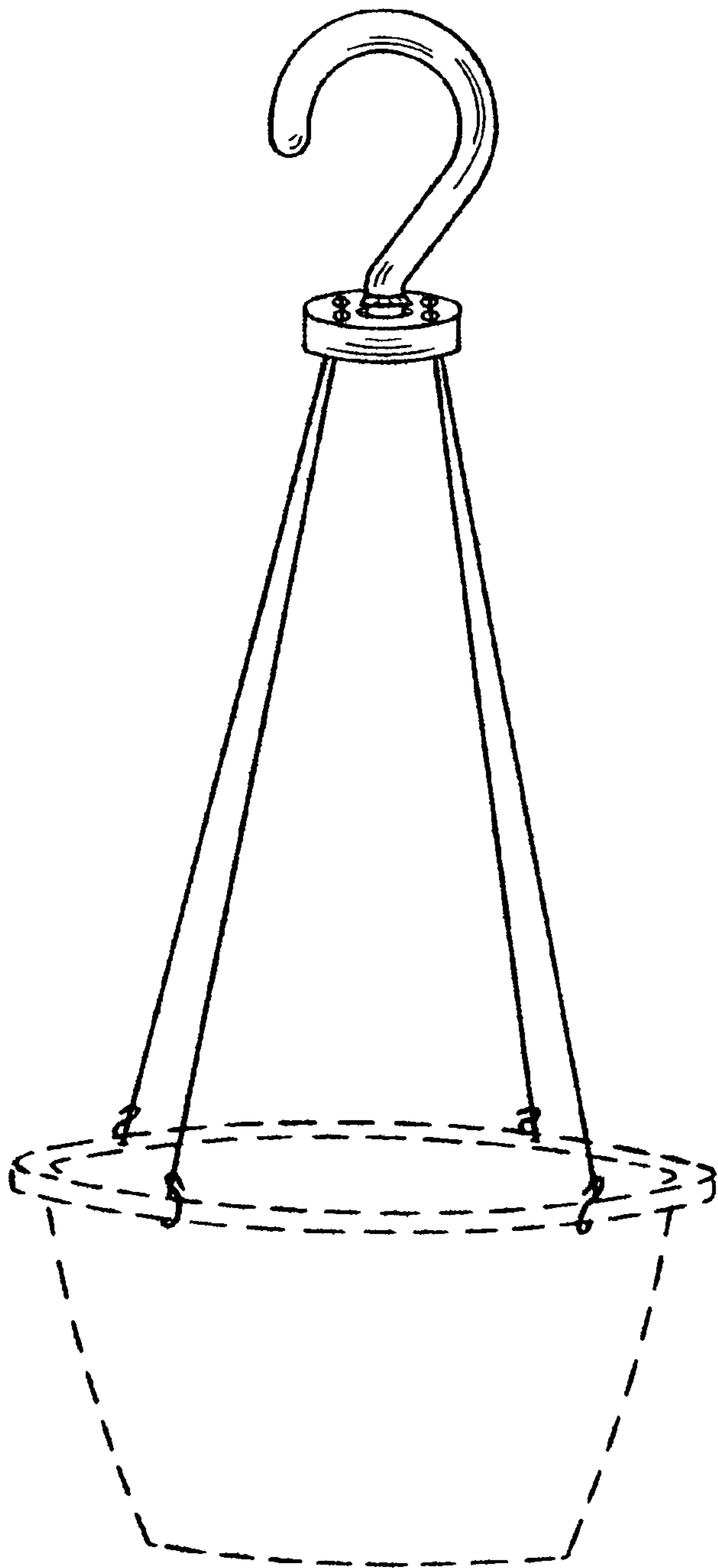
FIG. 29 is a top plan view thereof, shown disassembled; and  
FIG. 30 is a bottom plan view thereof, shown disassembled.  
FIG. 31 is a perspective view of a sixth embodiment of a rotational plant basket hanger;  
FIG. 32 is a perspective view thereof, shown disassembled;  
FIG. 33 is a top plan view thereof;  
FIG. 34 is a bottom plan view thereof;  
FIG. 35 is a top plan view thereof, shown disassembled; and  
FIG. 36 is a bottom plan view thereof, shown disassembled.  
FIG. 37 is a perspective view of a seventh embodiment of a rotational plant basket hanger;  
FIG. 38 is a perspective view thereof, shown disassembled;  
FIG. 39 is a top plan view thereof;  
FIG. 40 is a bottom plan view thereof;  
FIG. 41 is a top plan view thereof, shown disassembled; and  
FIG. 42 is a bottom plan view thereof, shown disassembled.  
FIG. 43 is a perspective view of an eighth embodiment of a rotational plant basket hanger;  
FIG. 44 is a perspective view thereof, shown disassembled;  
FIG. 45 is a top plan view thereof;  
FIG. 46 is a bottom plan view thereof;  
FIG. 47 is a top plan view thereof, shown disassembled; and  
FIG. 48 is a bottom plan view thereof, shown disassembled.  
FIG. 49 is a perspective view of a ninth embodiment of a rotational plant basket hanger, shown disassembled;  
FIG. 50 is a top plan view thereof;  
FIG. 51 is a bottom plan view thereof;  
FIG. 52 is a top plan view thereof, shown disassembled; and  
FIG. 53 is a bottom plan view thereof, shown disassembled.  
FIG. 54 is a perspective view of a tenth embodiment of a rotational plant basket hanger, shown disassembled;

FIG. 55 is a top plan view thereof;  
FIG. 56 is a bottom plan view thereof;  
FIG. 57 is a top plan view thereof, shown disassembled; and  
FIG. 58 is a bottom plan view thereof, shown disassembled.  
FIG. 59 is a perspective view of an eleventh embodiment of a rotational plant basket hanger, shown disassembled;  
FIG. 60 is a top plan view thereof;  
FIG. 61 is a bottom plan view thereof.  
FIG. 62 is a perspective view of a twelfth embodiment of a rotational plant basket hanger, shown disassembled;  
FIG. 63 is a top plan view thereof;  
FIG. 64 is a bottom plan view thereof.  
FIG. 65 is a perspective view of a thirteenth embodiment of a rotational plant basket hanger, shown disassembled;  
FIG. 66 is a top plan view thereof;  
FIG. 67 is a bottom plan view thereof.  
FIG. 68 is a perspective view of a fourteenth embodiment of a rotational plant basket hanger, shown disassembled;  
FIG. 69 is a top plan view thereof; and,  
FIG. 70 is a bottom plan view thereof.

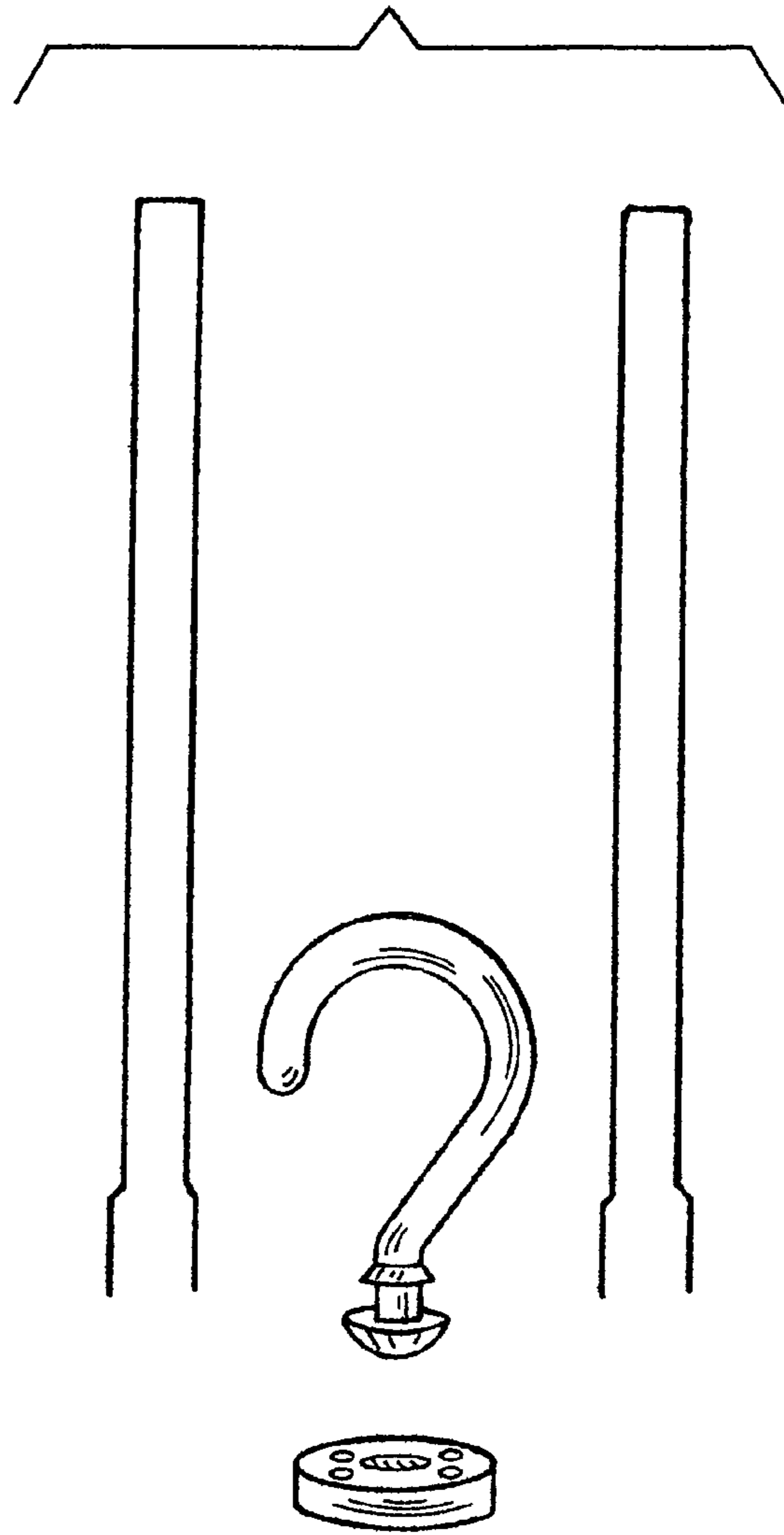
The claimed design is the design as shown applied to the full, assembled article in each embodiment. Figures which show the article disassembled are provided only to further the understanding of the assembled article by disclosing its various members.

The broken lines illustrating a flower pot in FIGS. 1 and 25 depict environmental subject matter only and form no part of the claimed design.

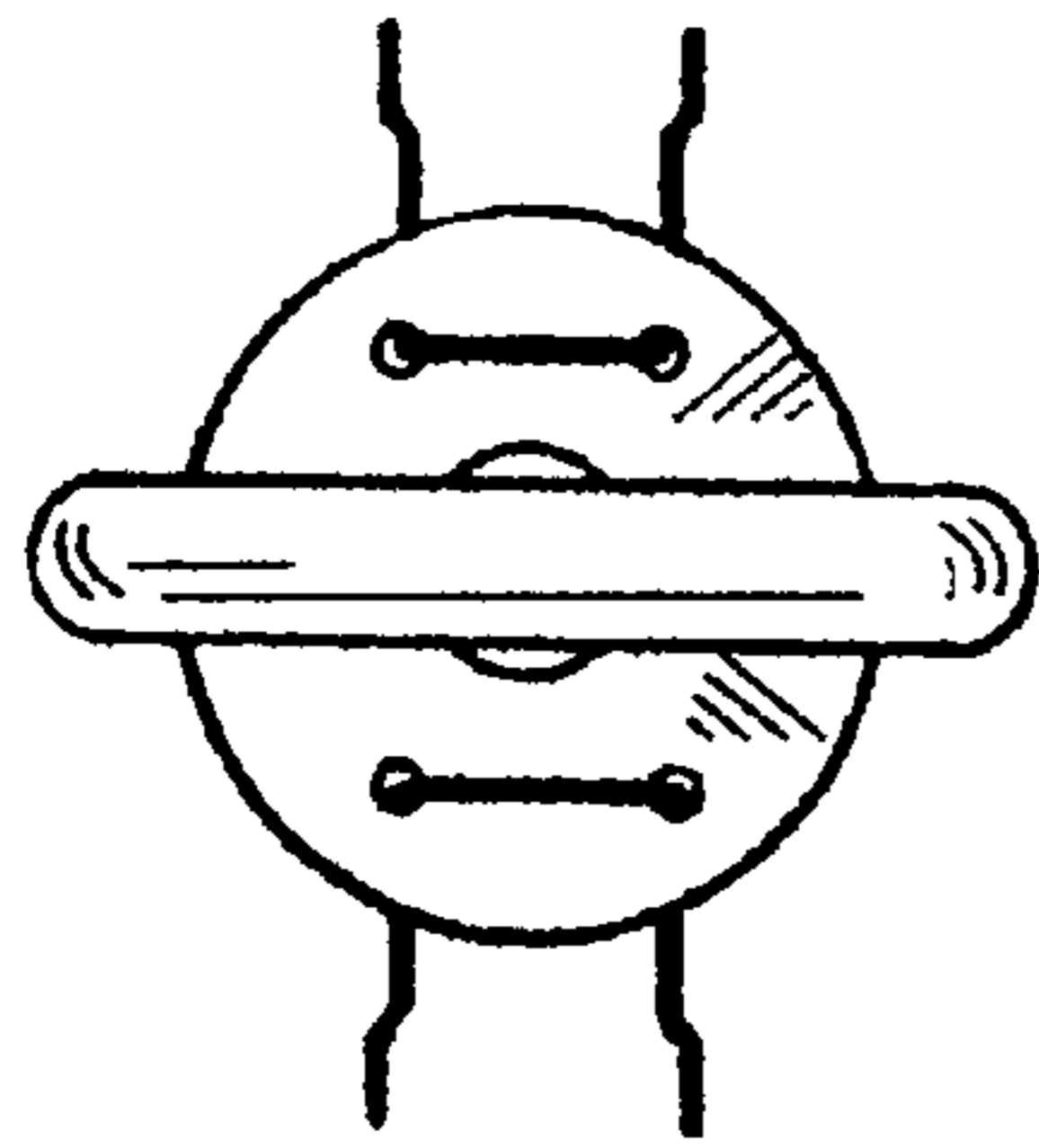
**1 Claim, 24 Drawing Sheets**



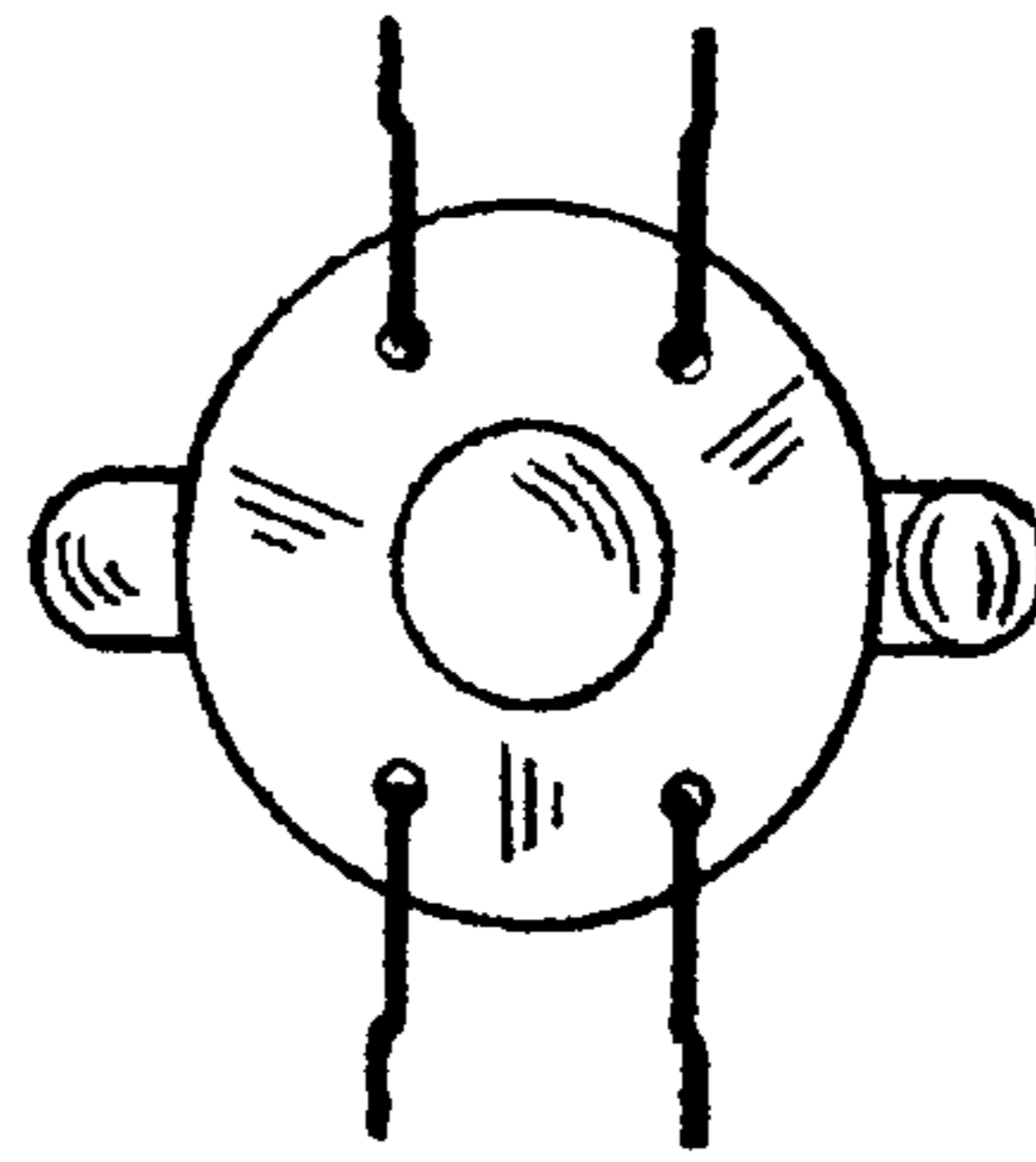
**FIG. 1**



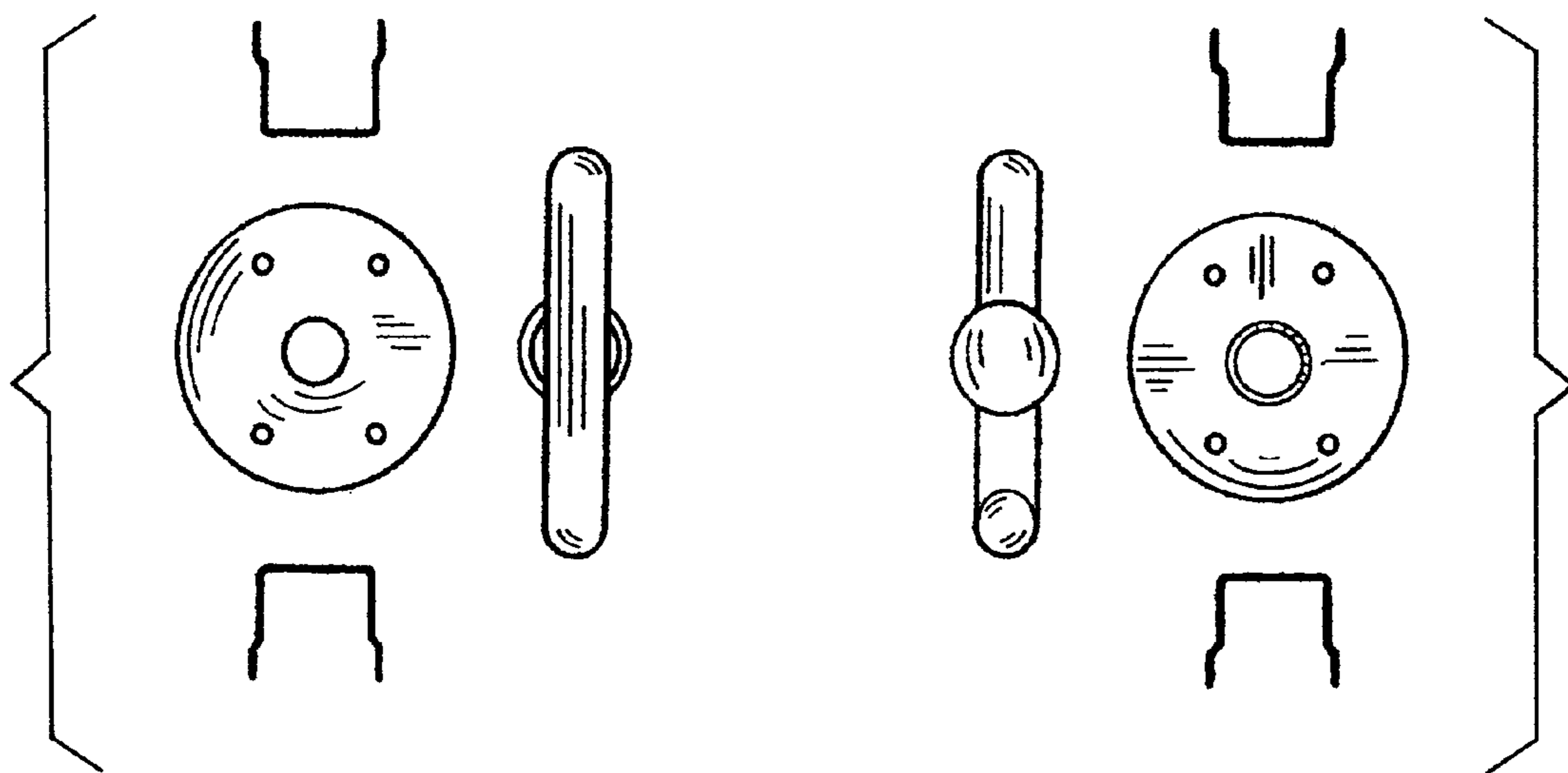
**FIG. 2**



**FIG. 3**

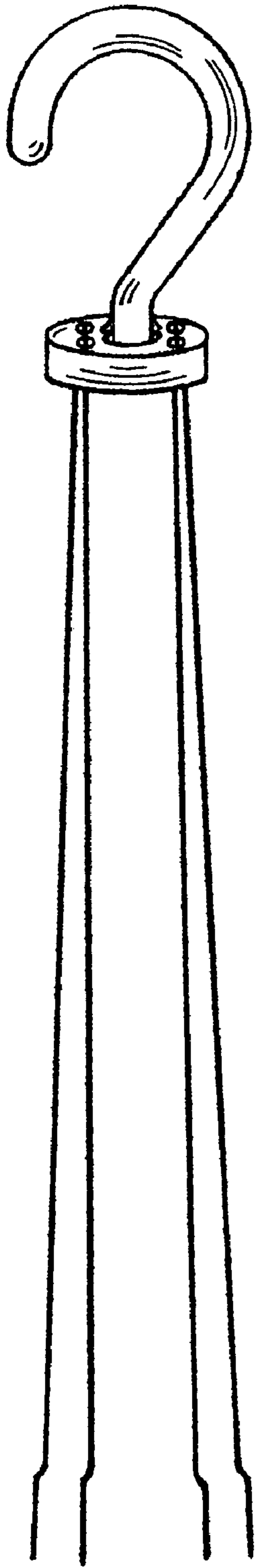


**FIG. 4**

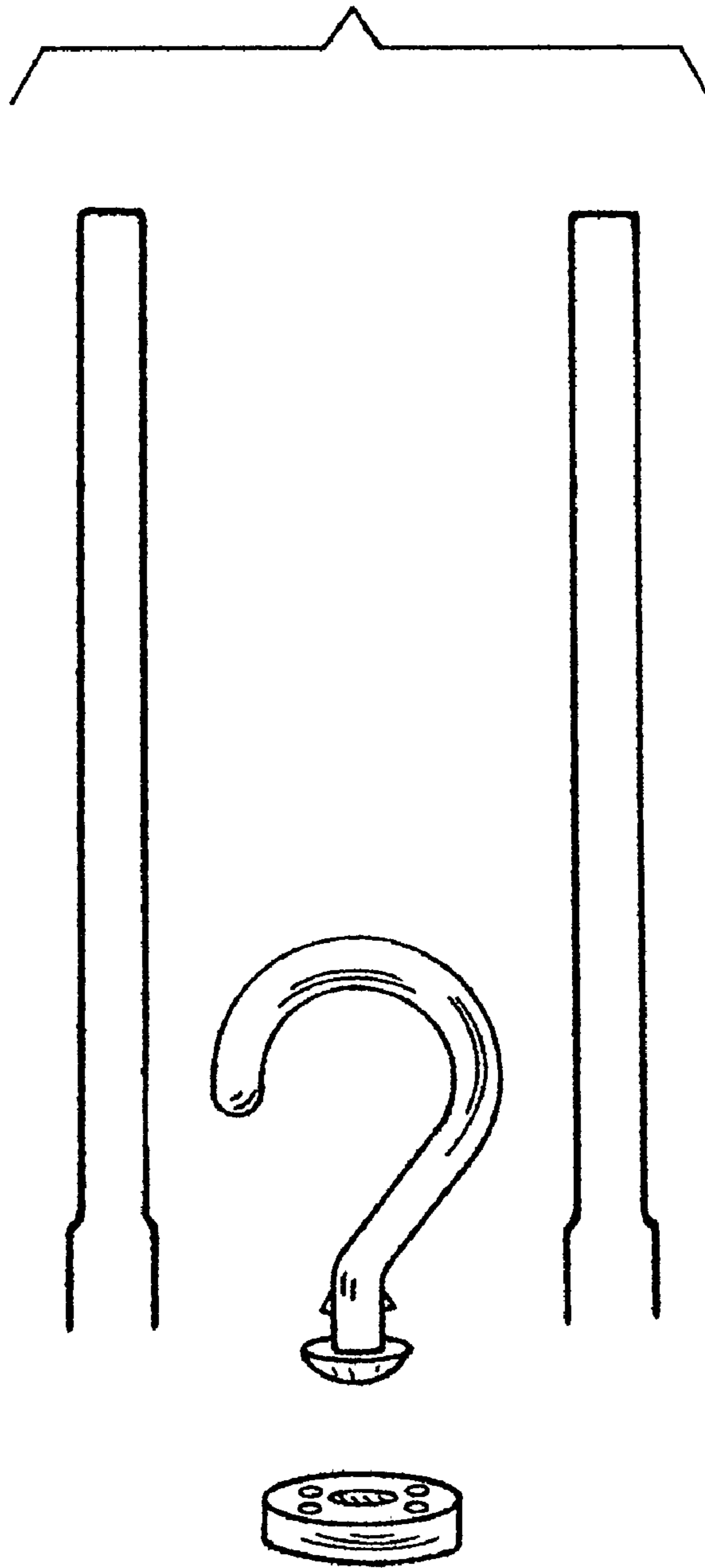


**FIG. 5**

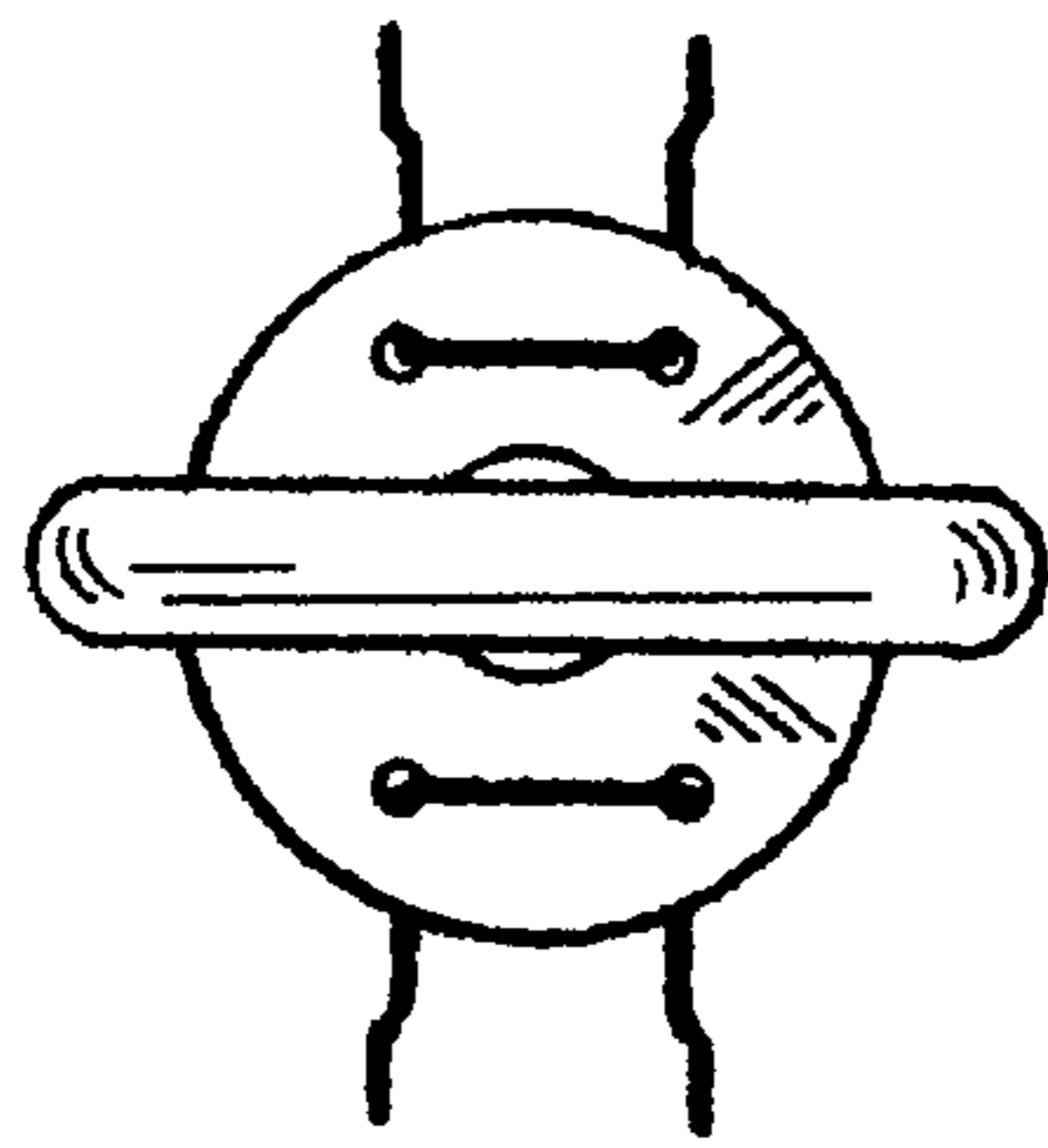
**FIG. 6**



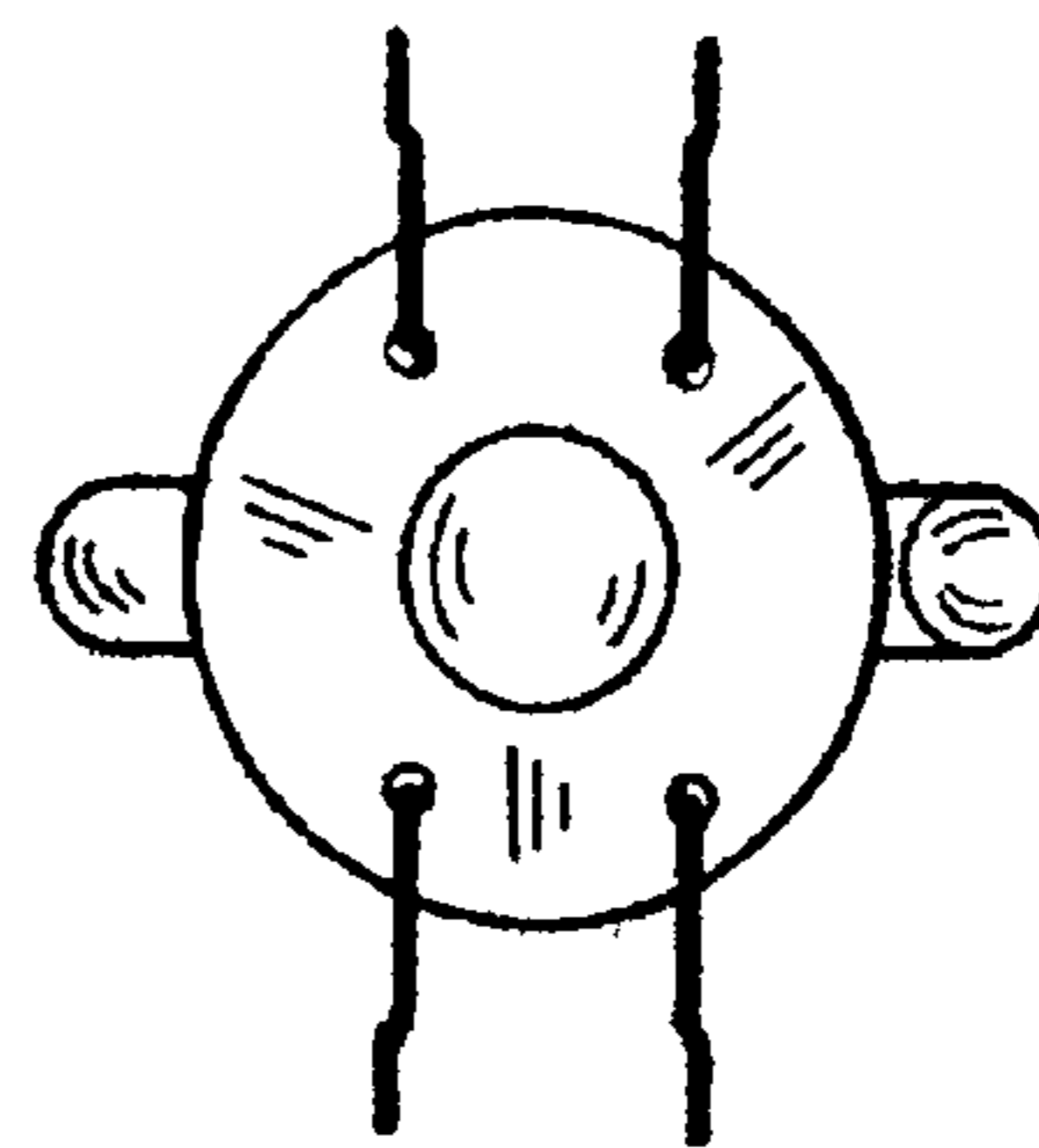
**FIG. 7**



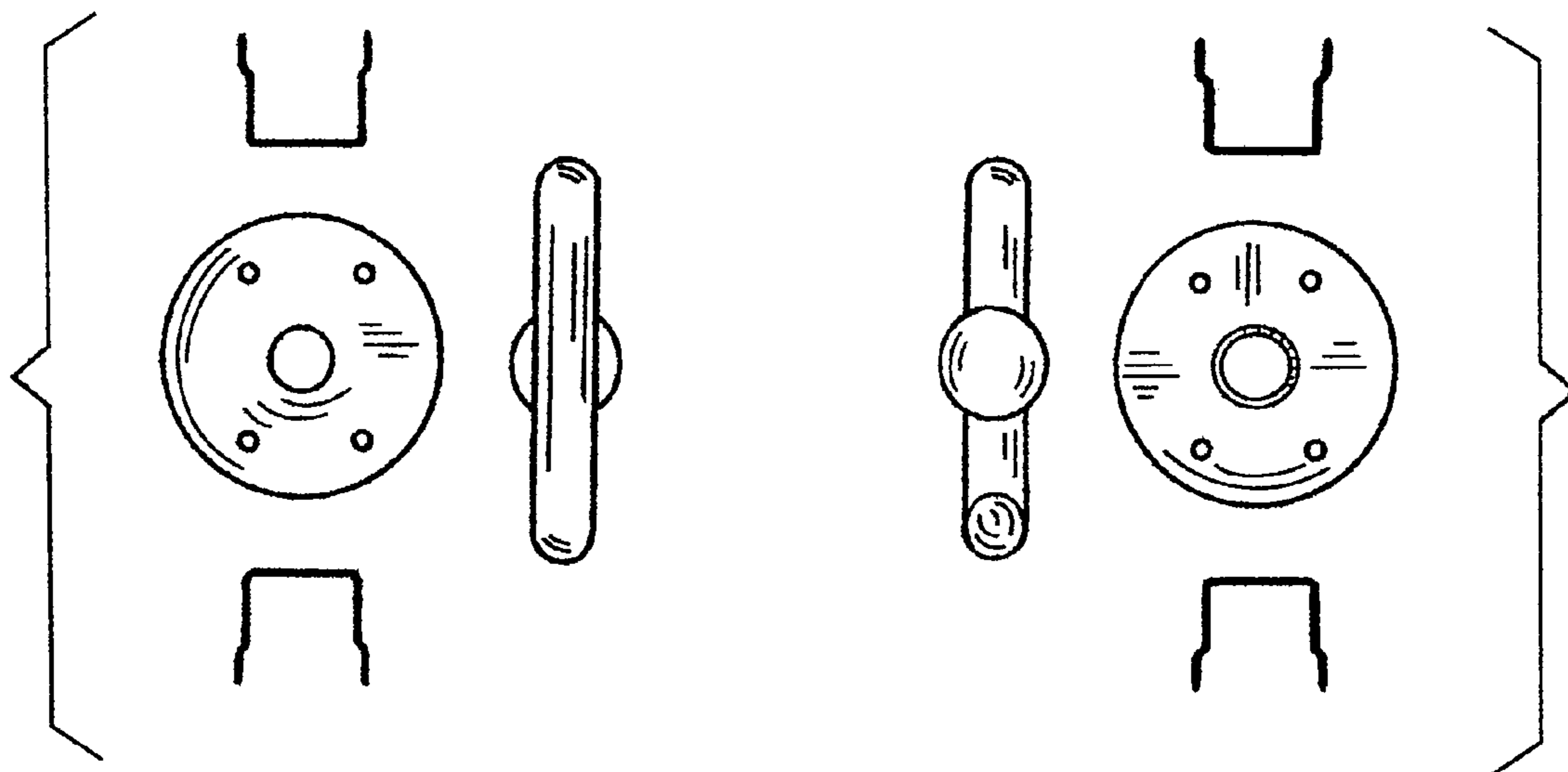
**FIG. 8**



**FIG. 9**

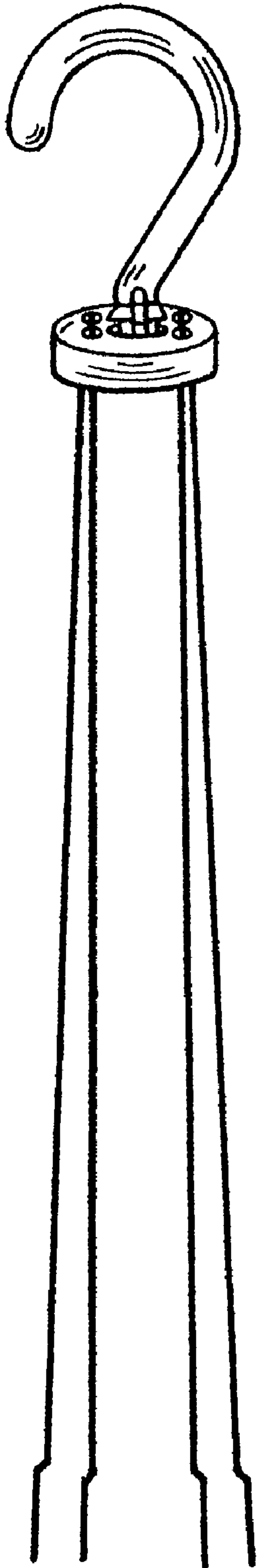


**FIG. 10**

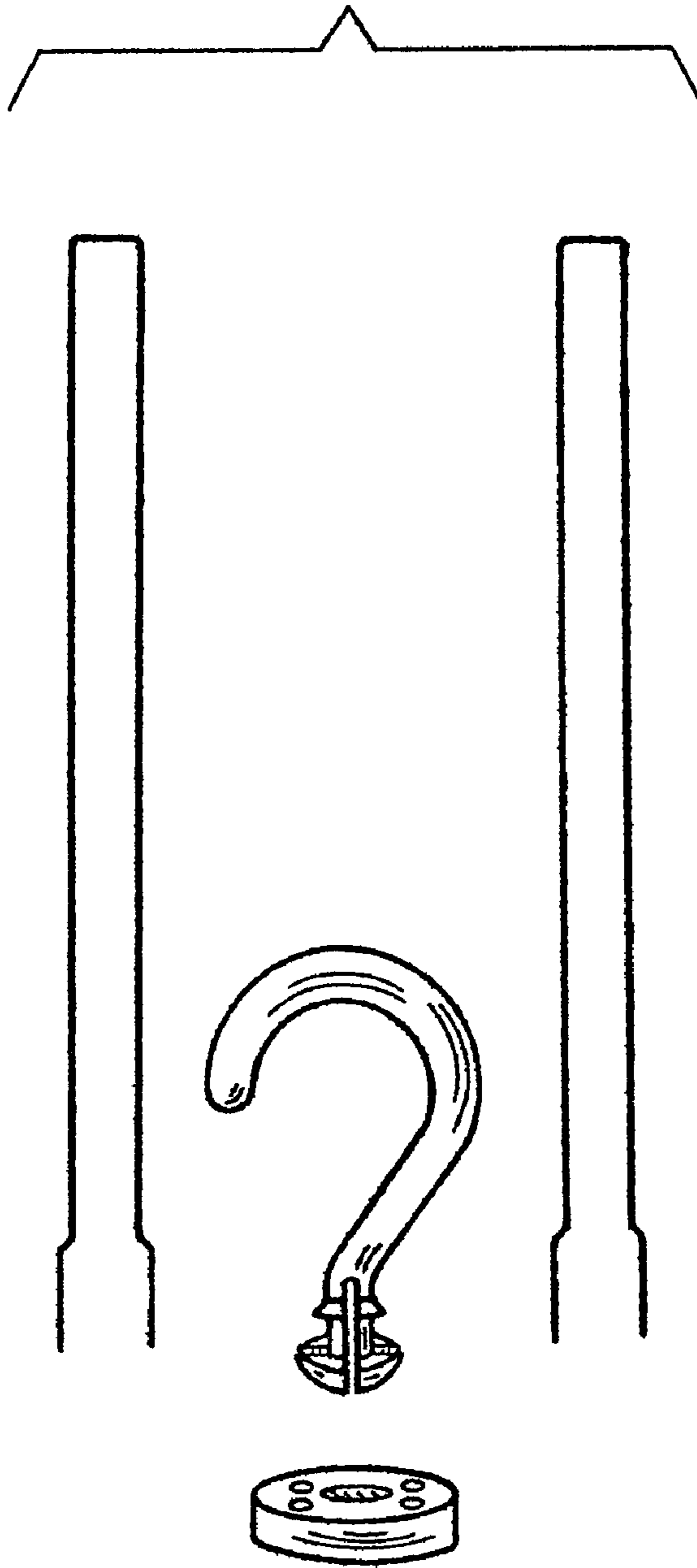


**FIG. 11**

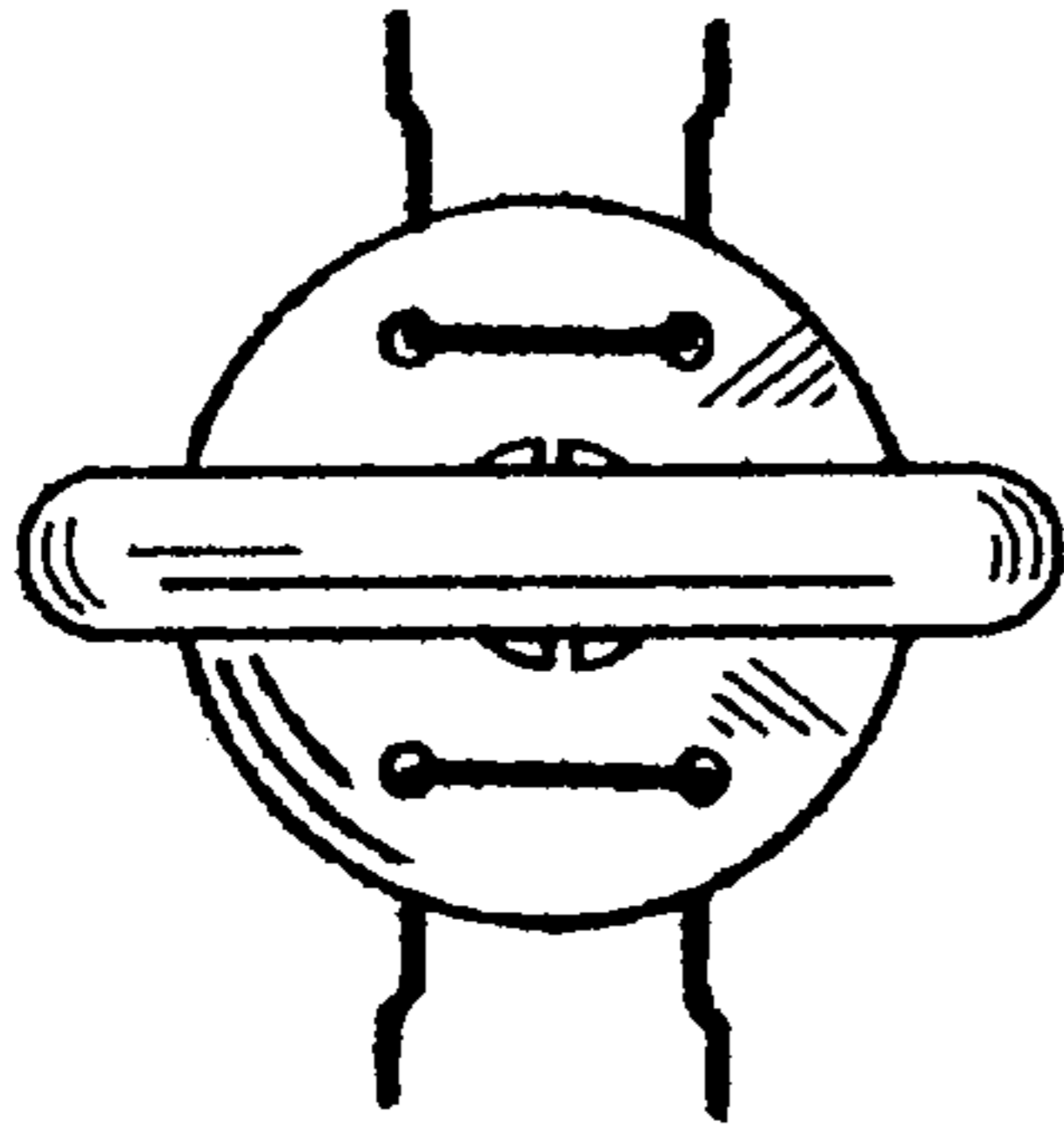
**FIG. 12**



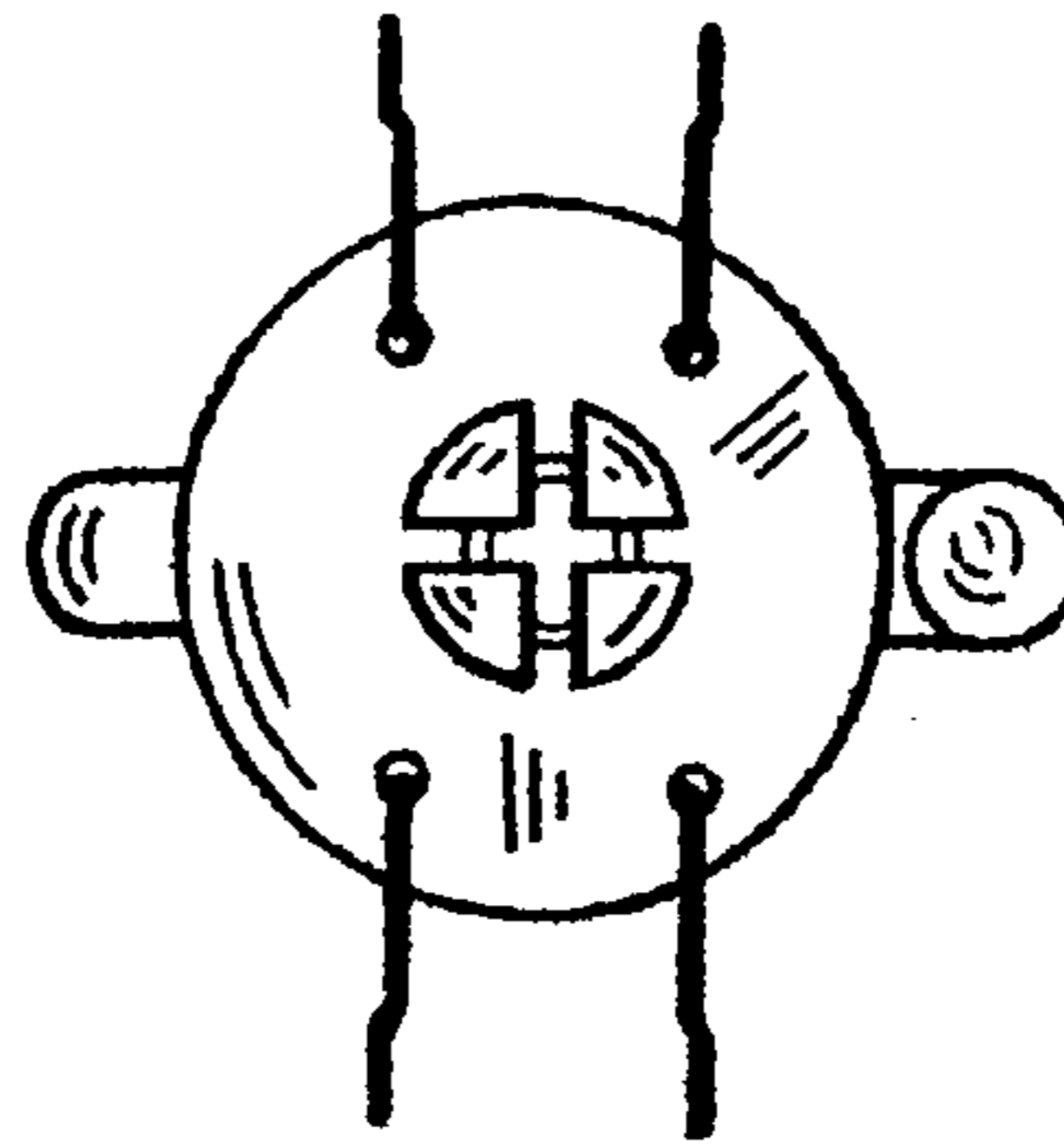
**FIG. 13**



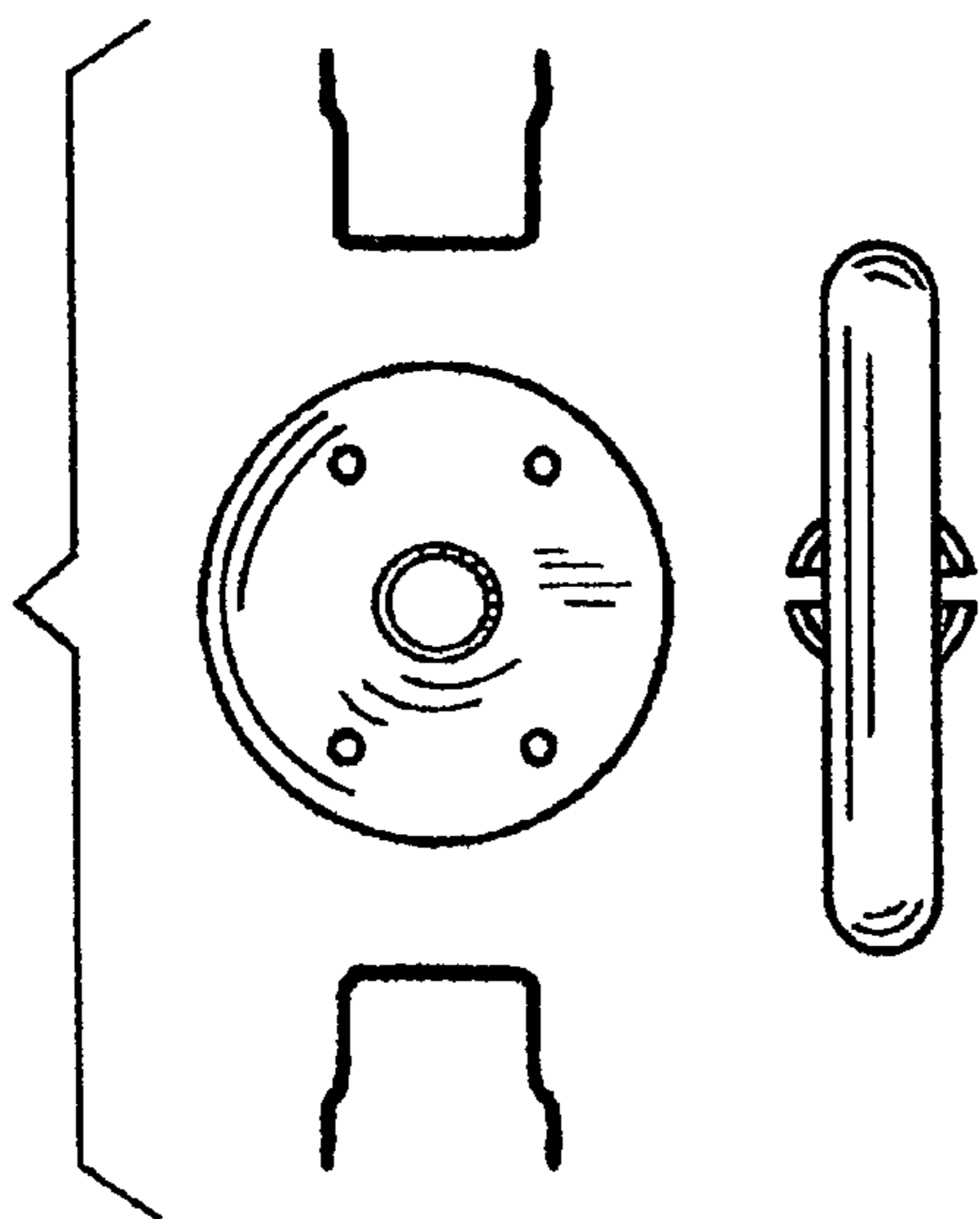
**FIG. 14**



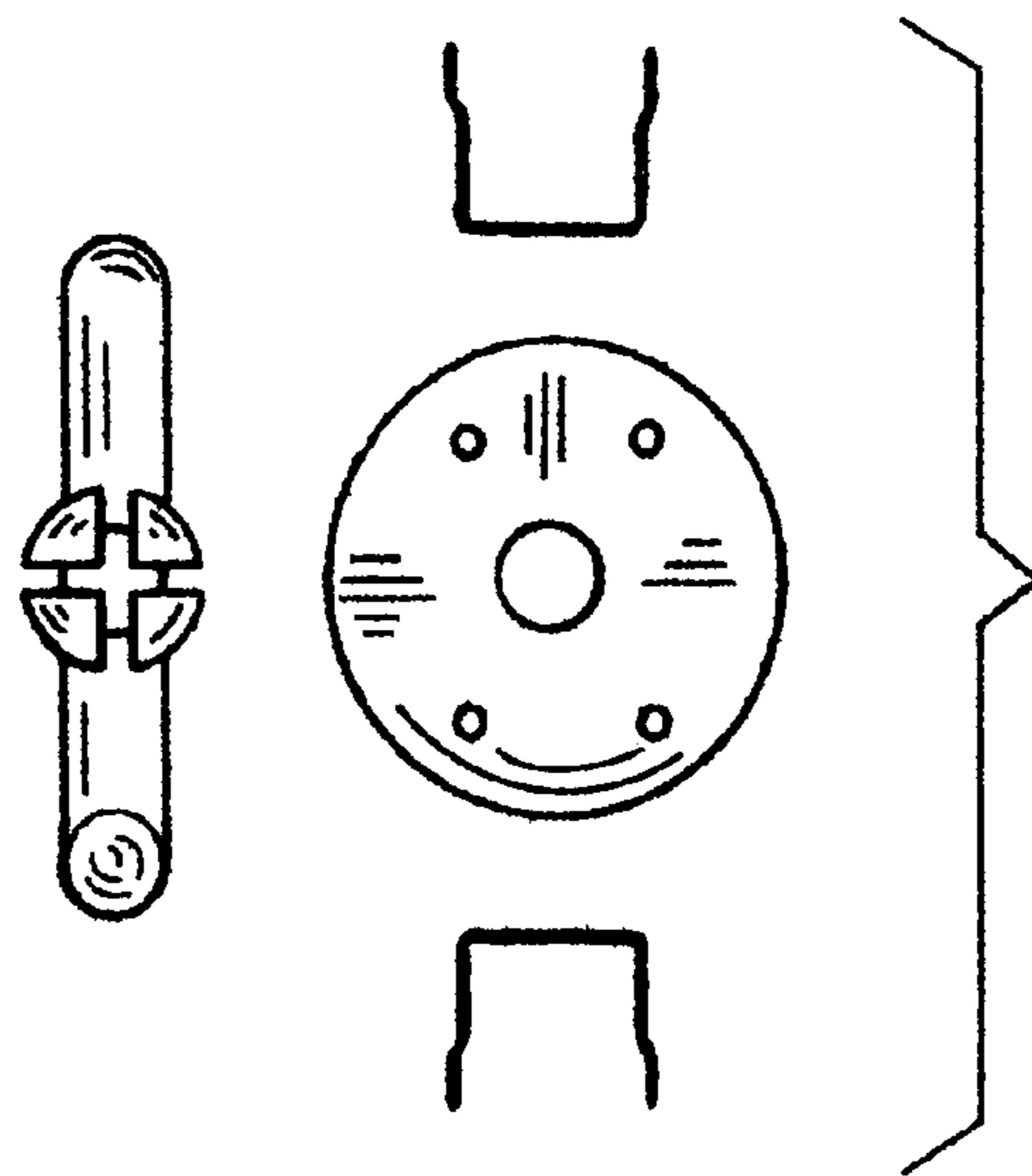
**FIG. 15**



**FIG. 16**

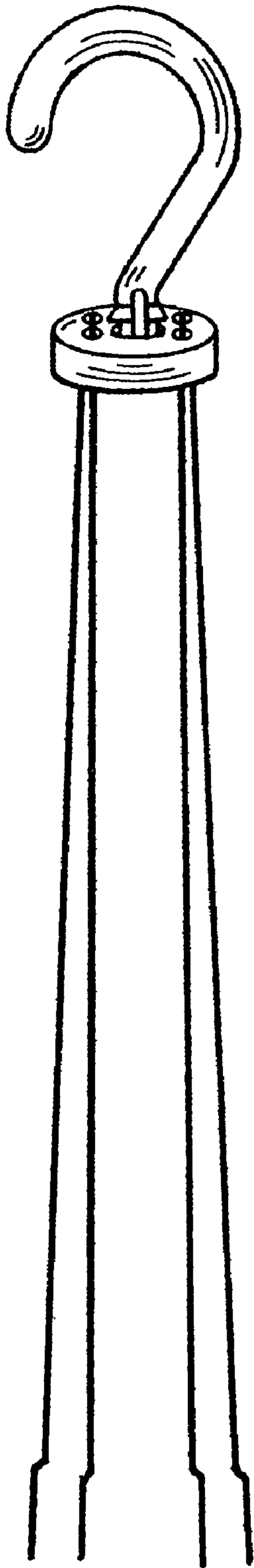


**FIG. 17**

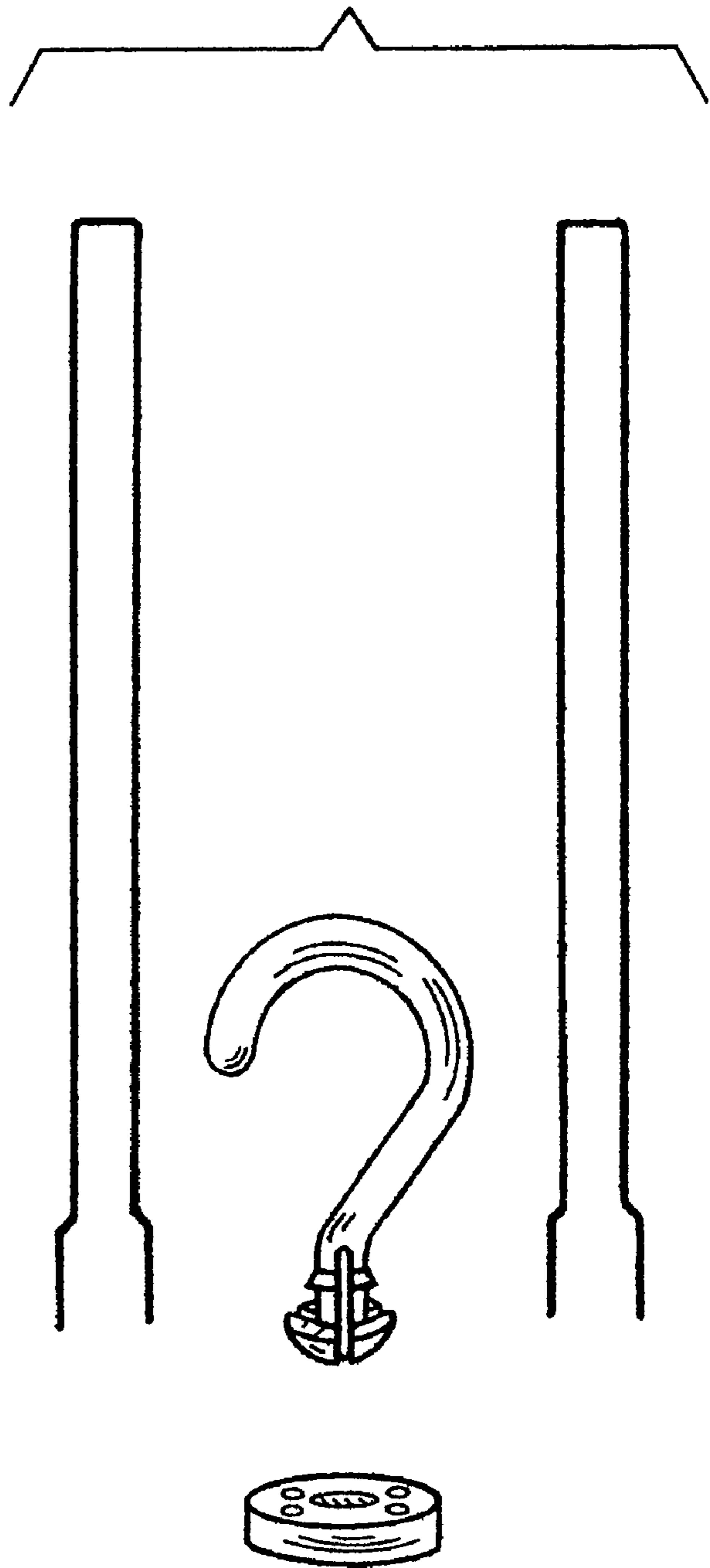


**FIG. 18**

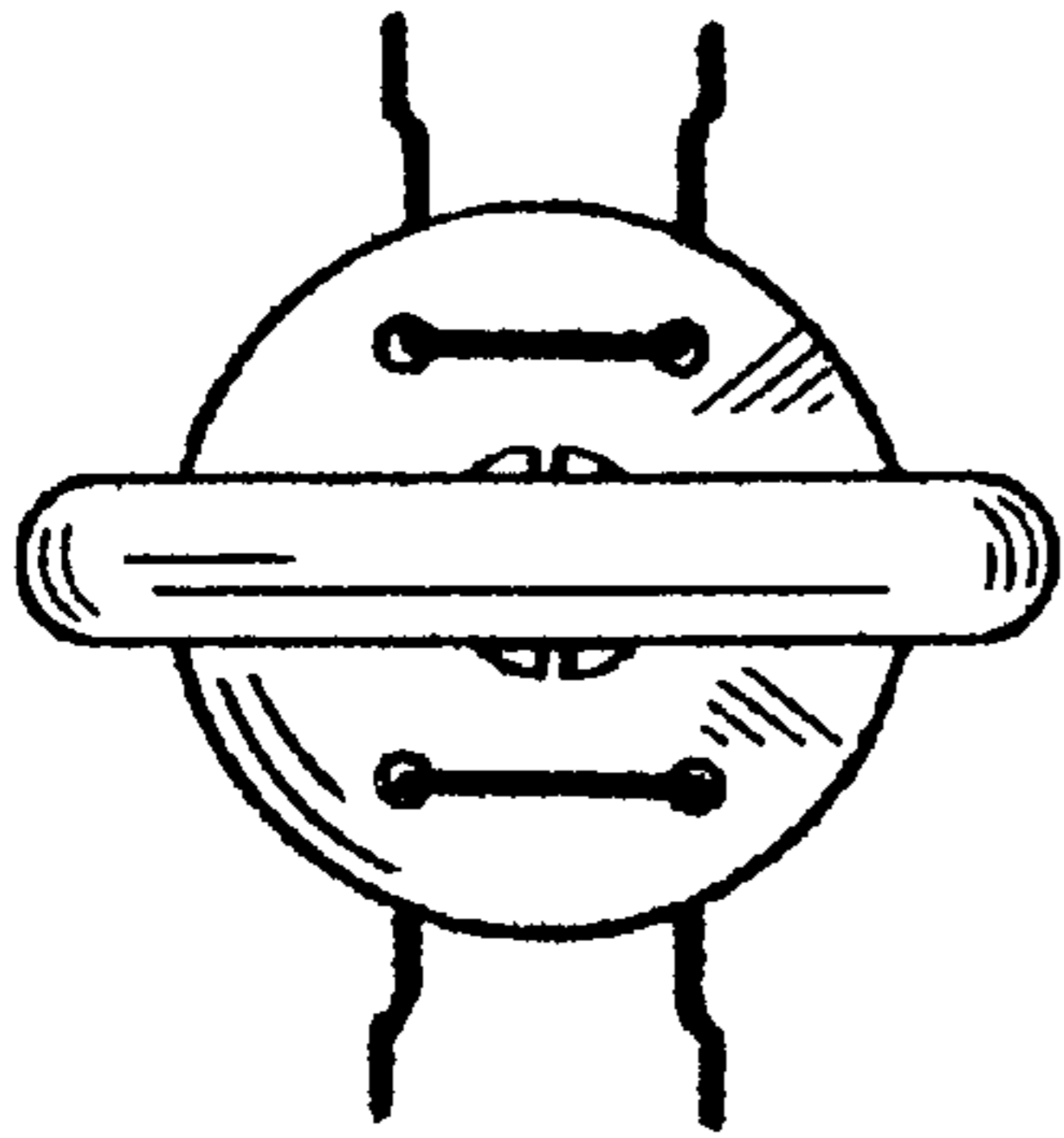




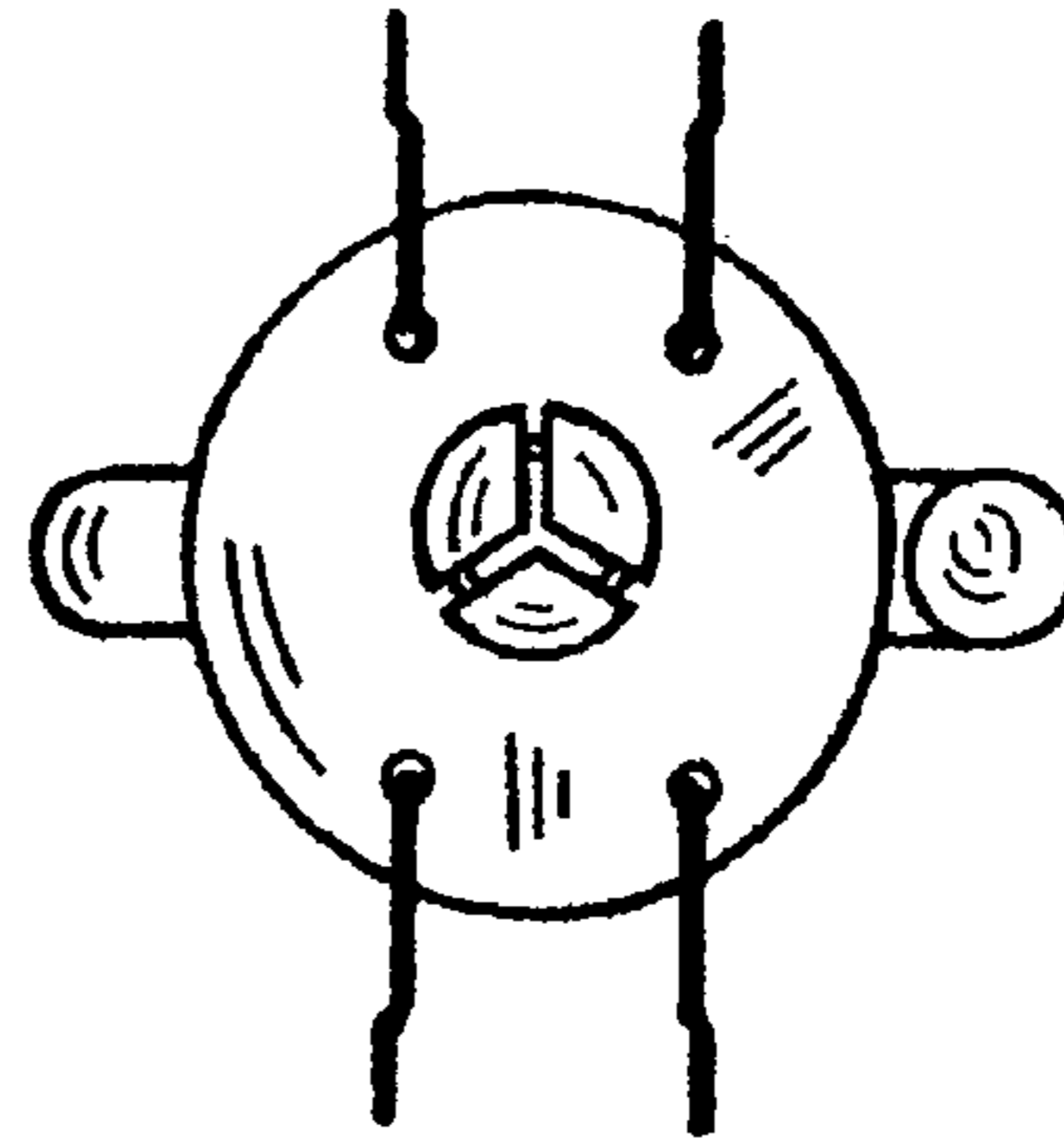
**FIG. 19**



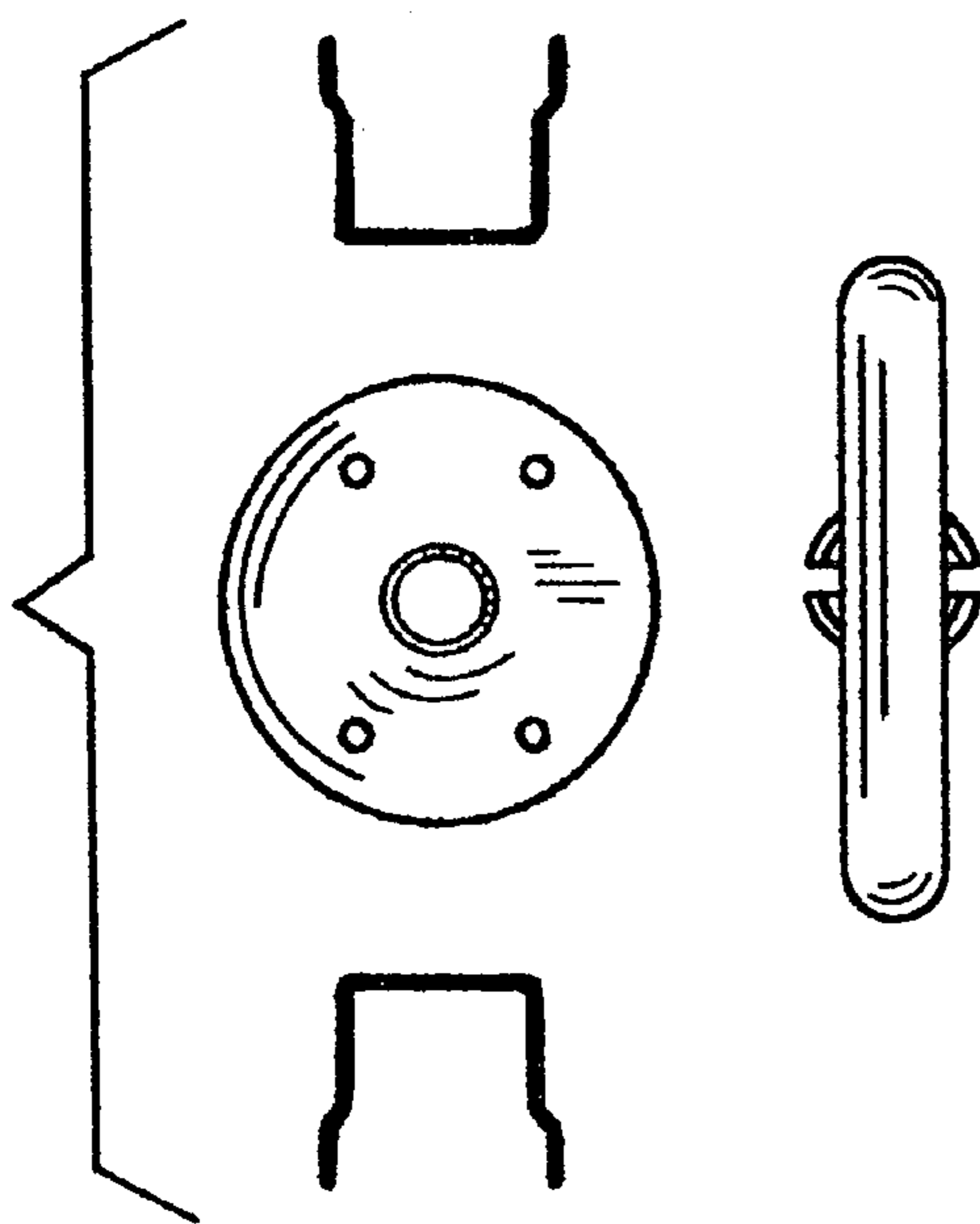
**FIG. 20**



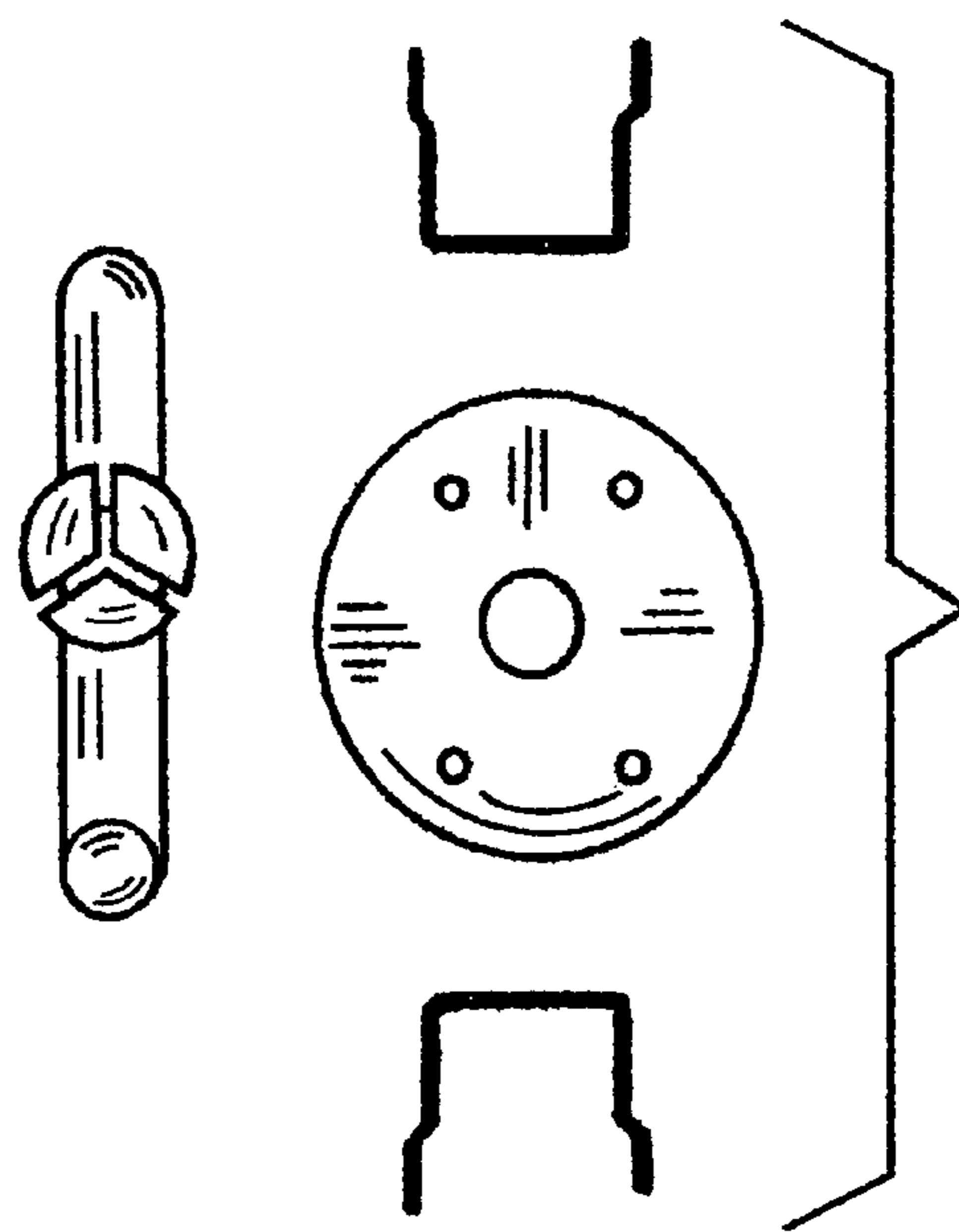
**FIG. 21**



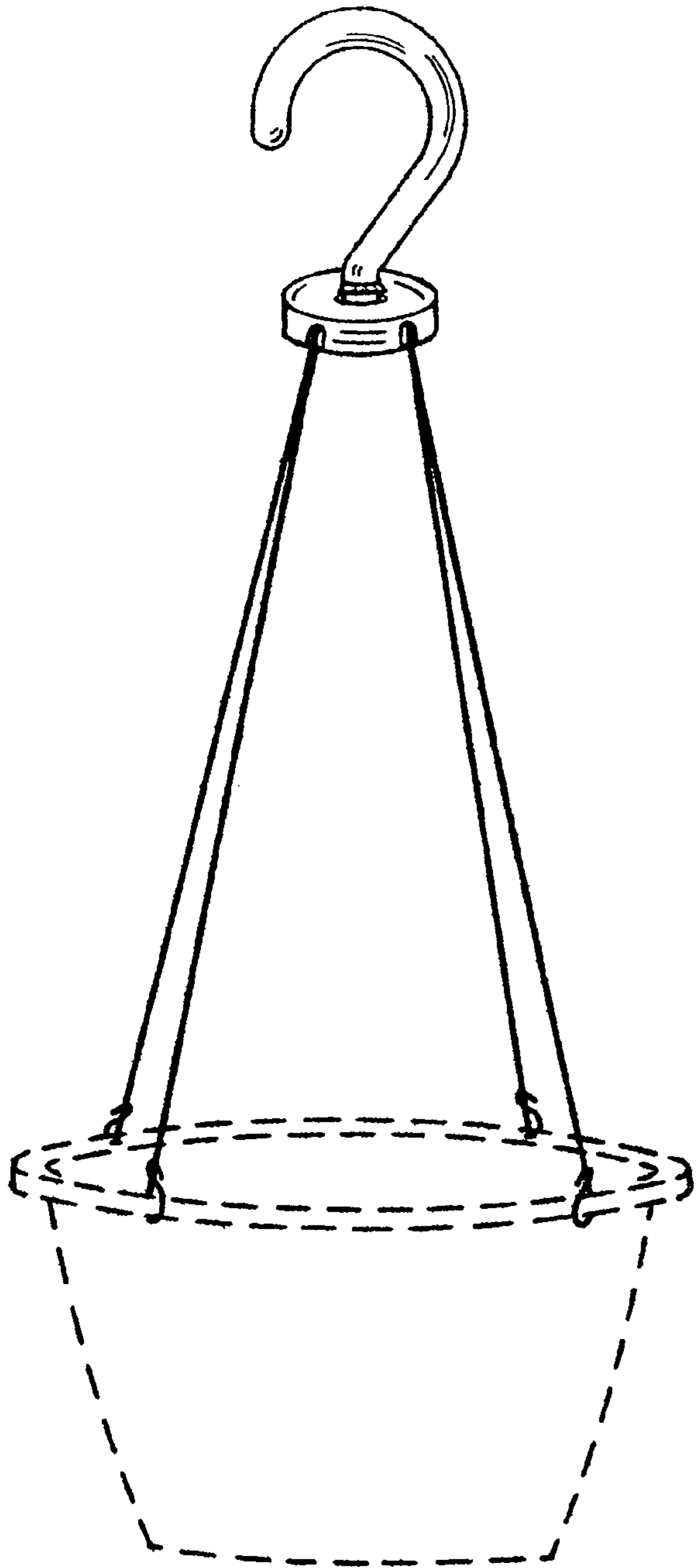
**FIG. 22**



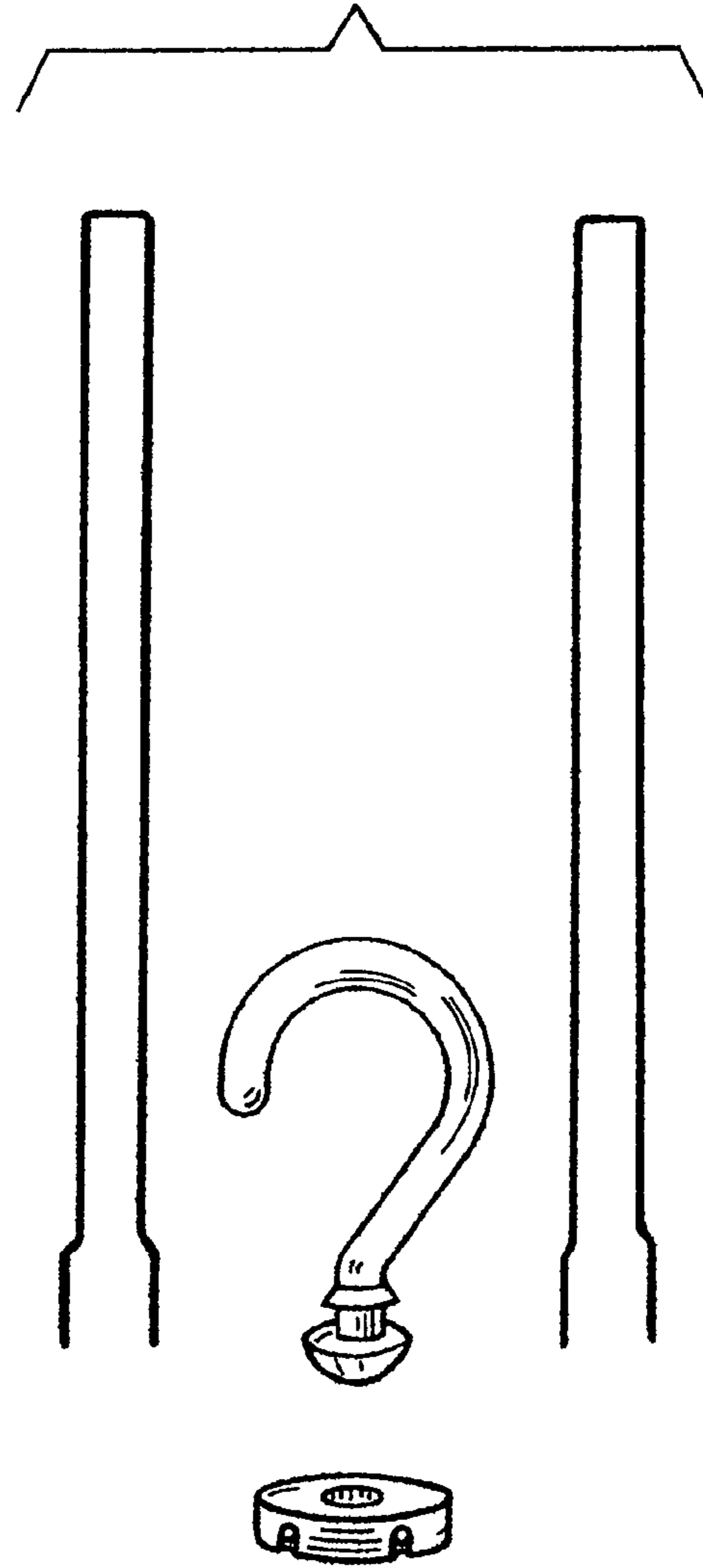
**FIG. 23**



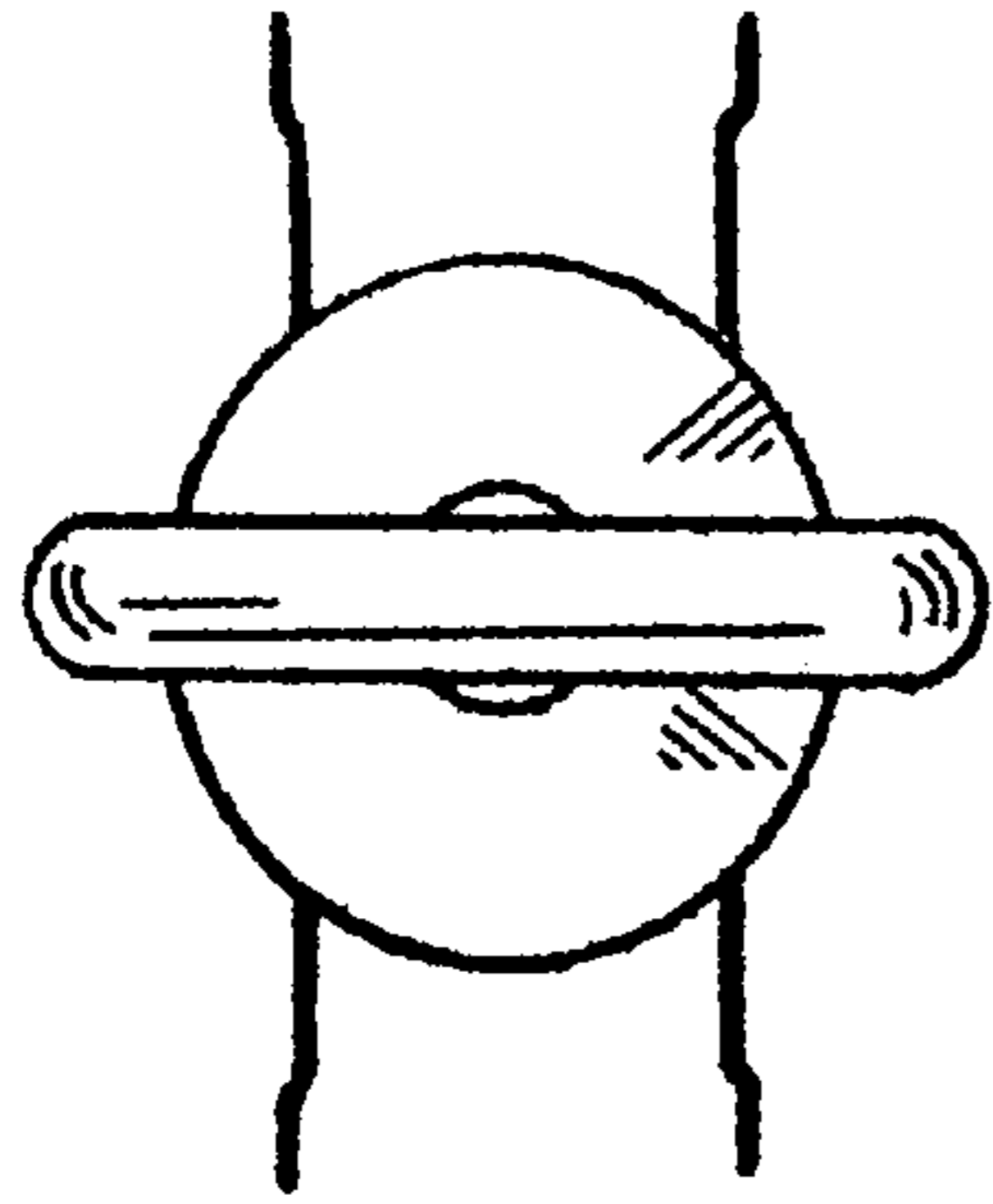
**FIG. 24**



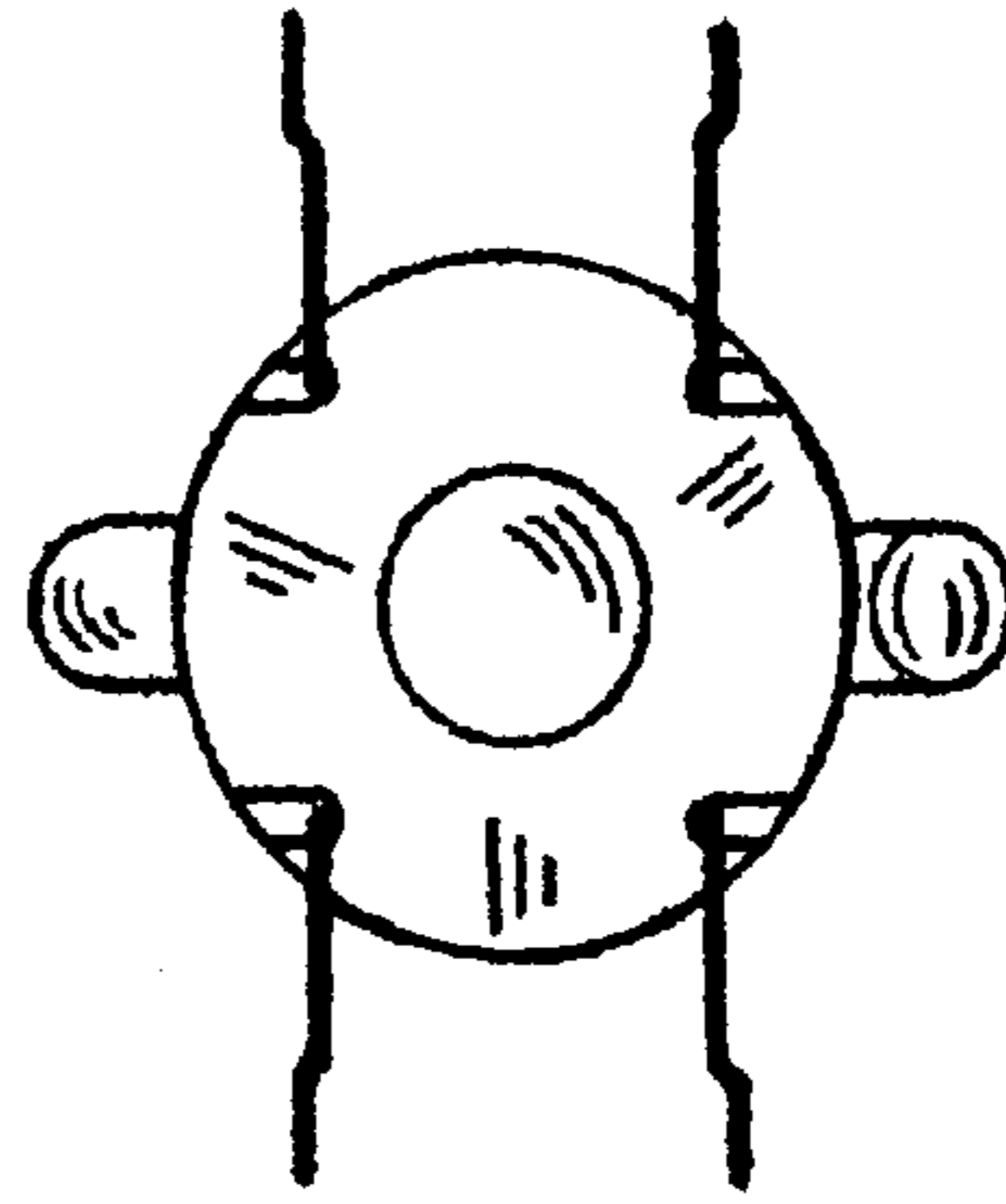
**FIG. 25**



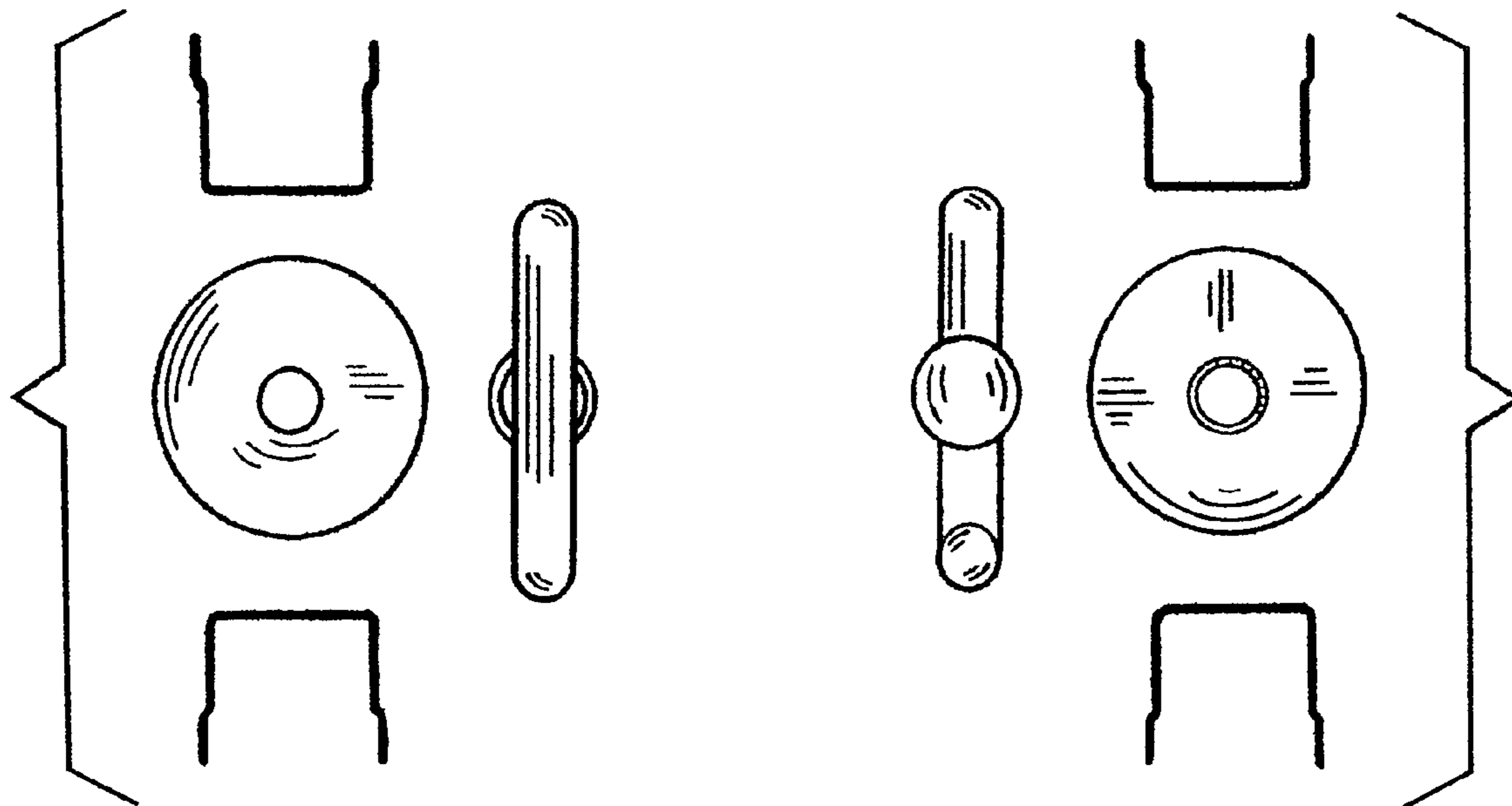
**FIG. 26**



**FIG. 27**

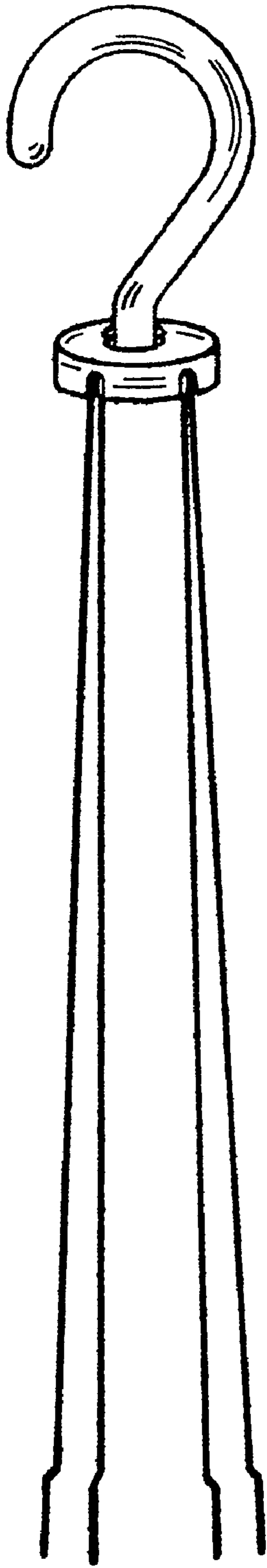


**FIG. 28**

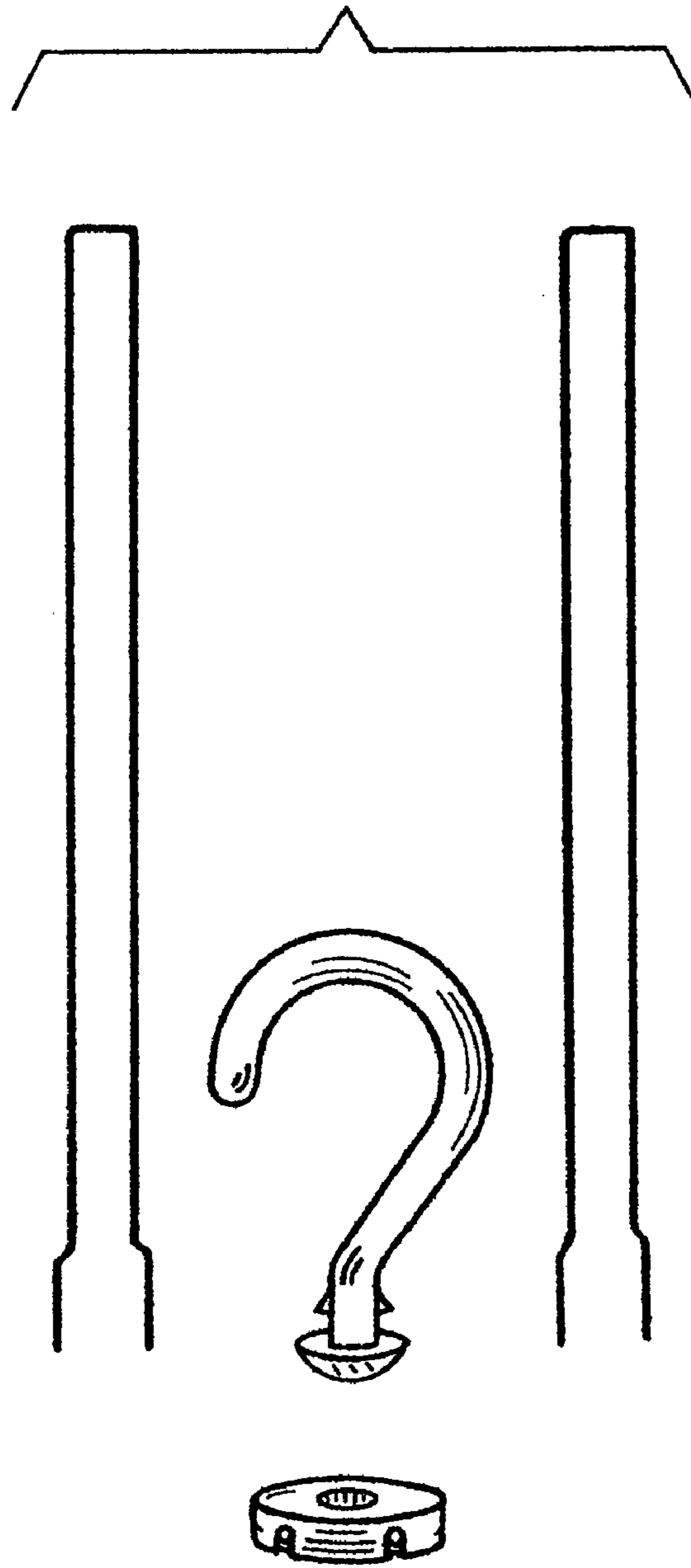


**FIG. 29**

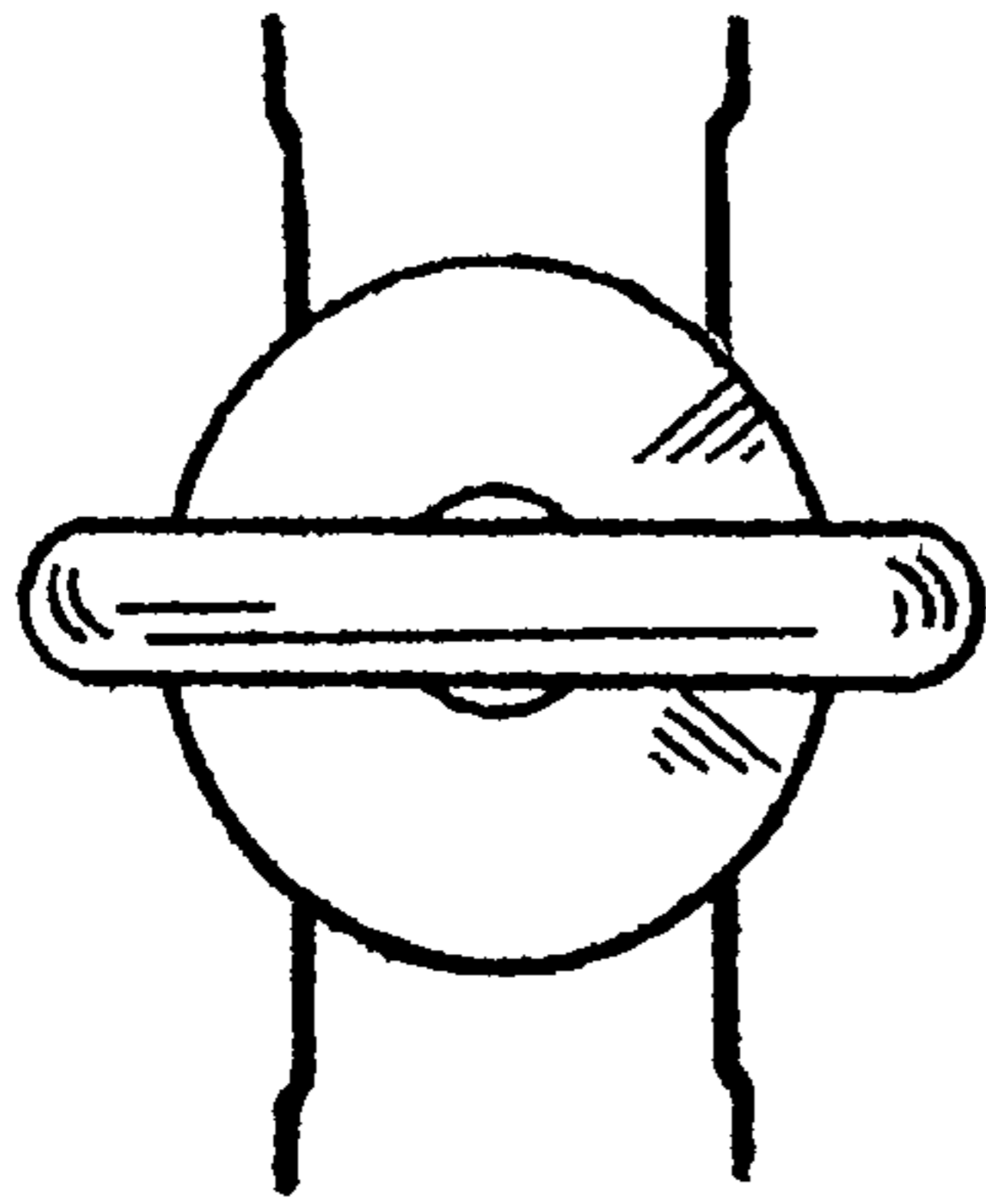
**FIG. 30**



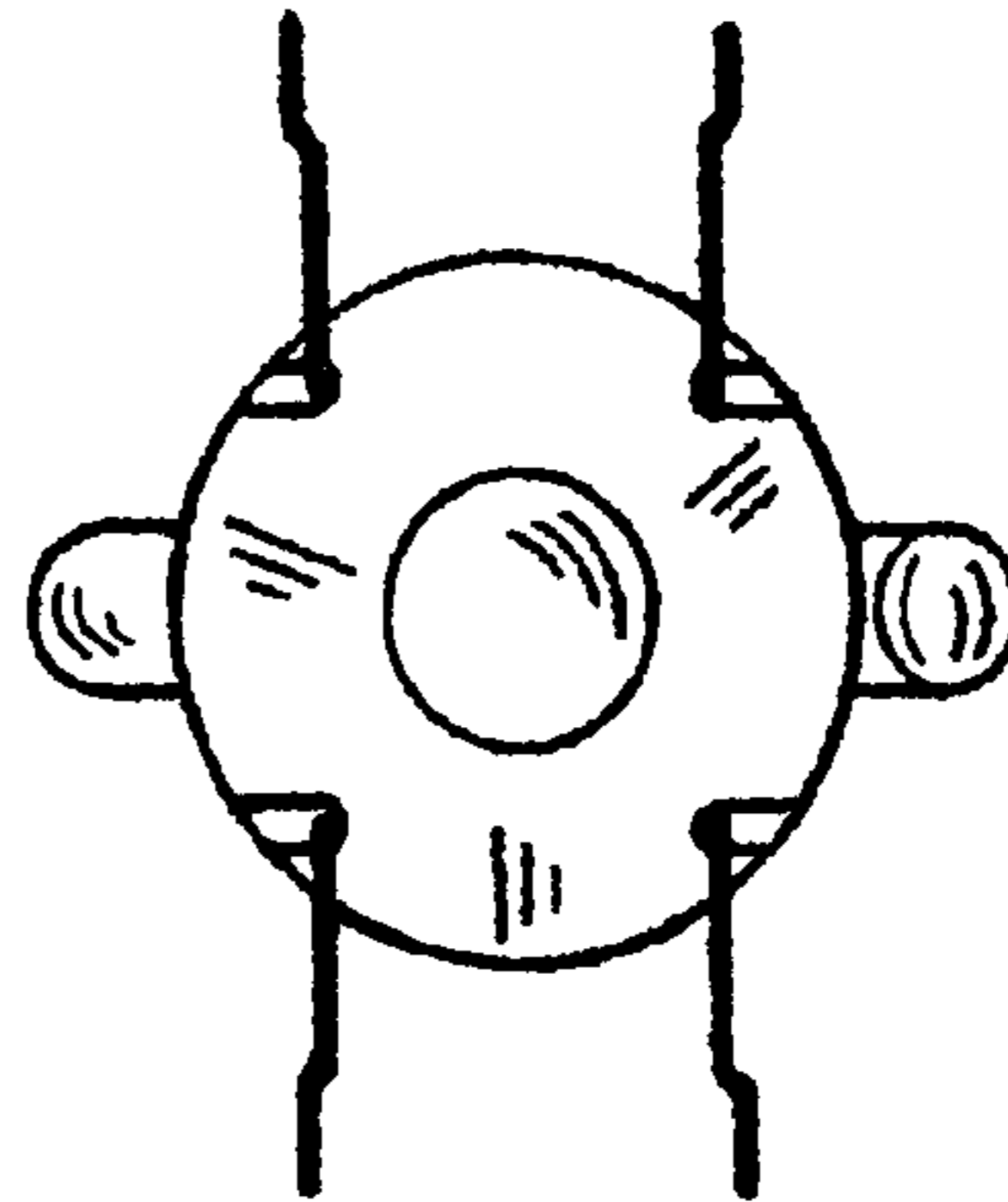
**FIG. 31**



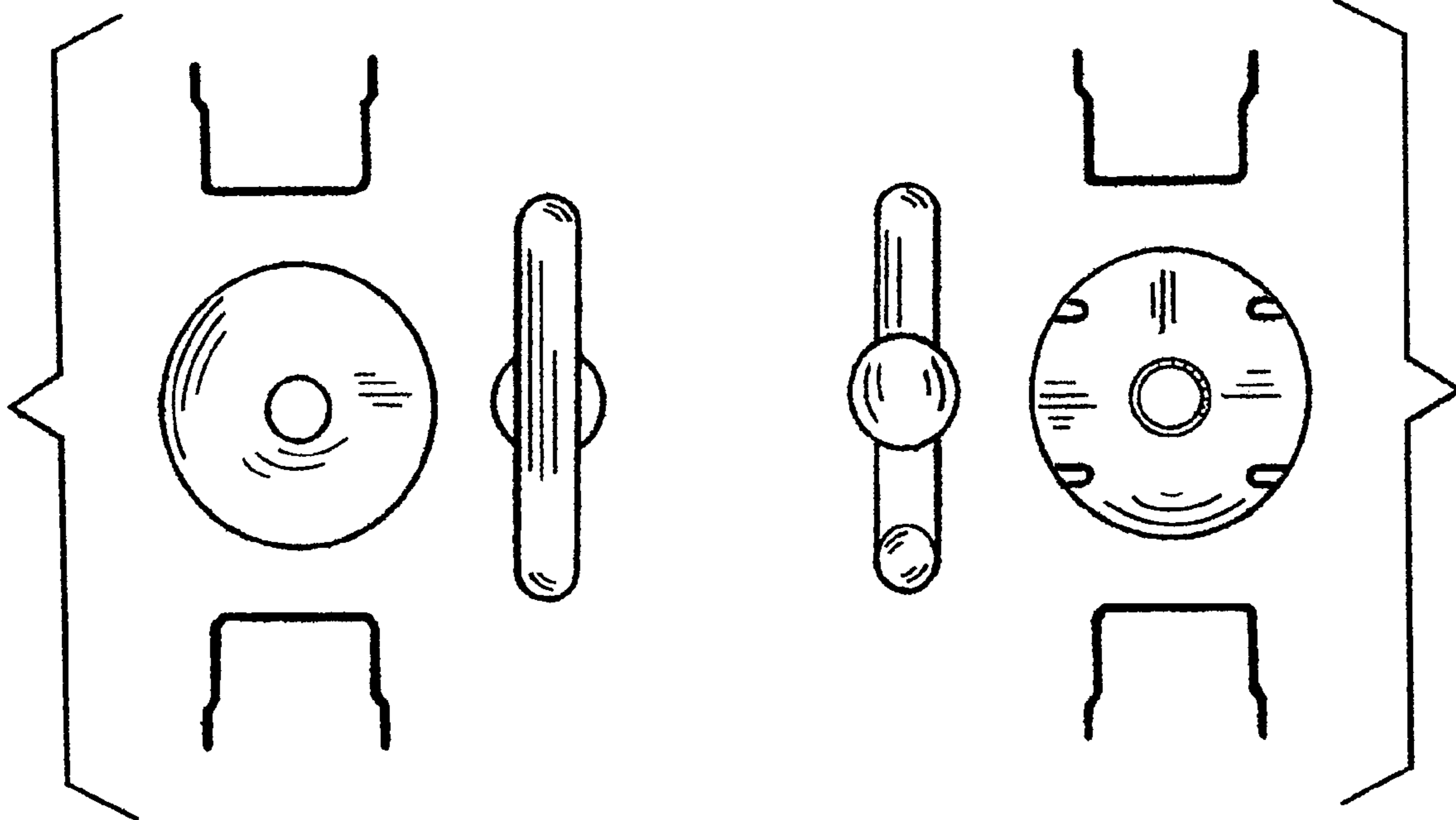
**FIG. 32**



**FIG. 33**

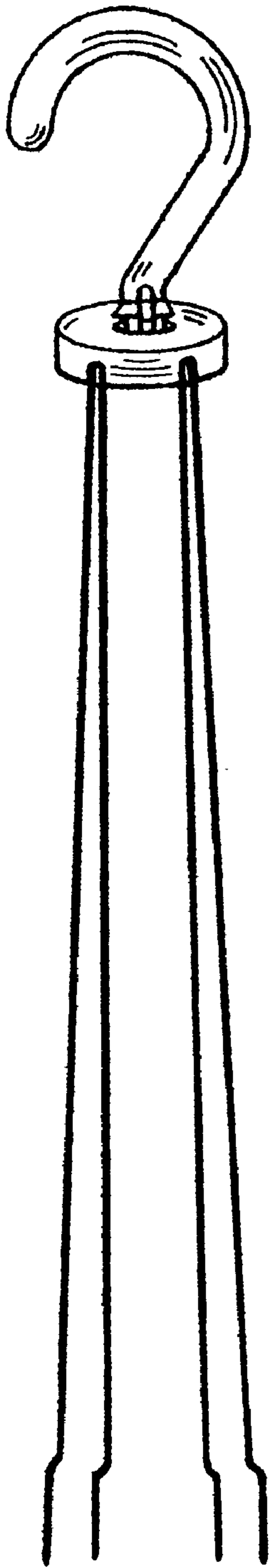


**FIG. 34**

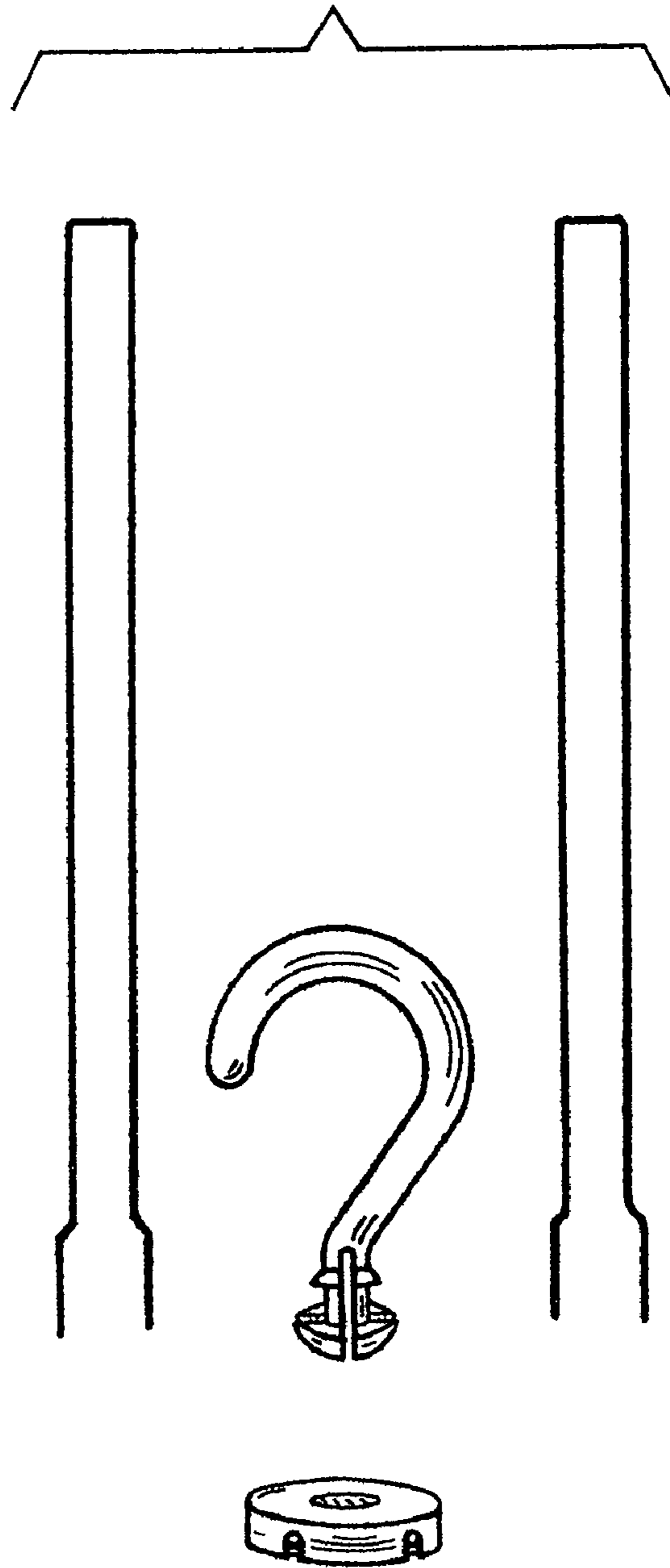


**FIG. 35**

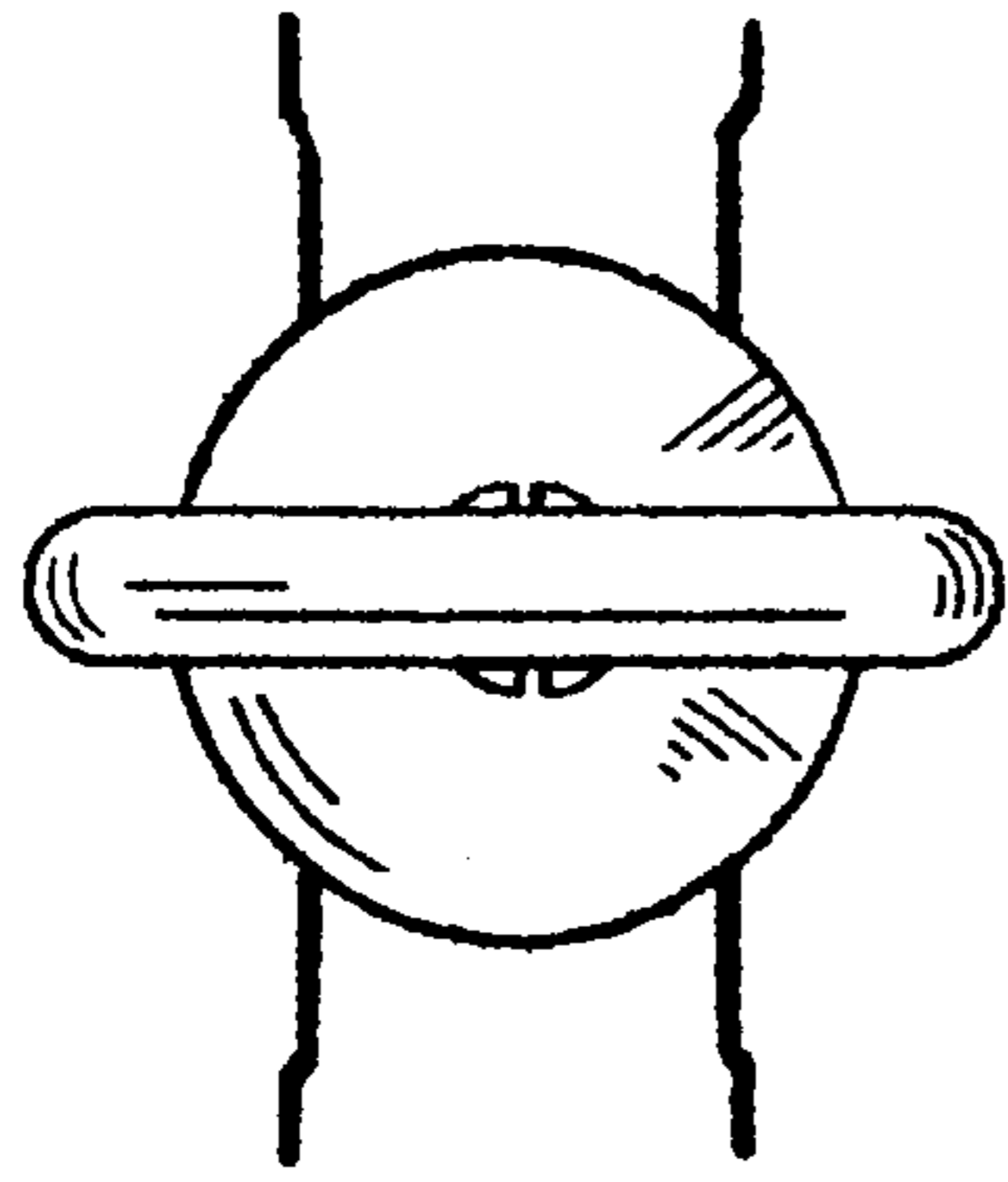
**FIG. 36**



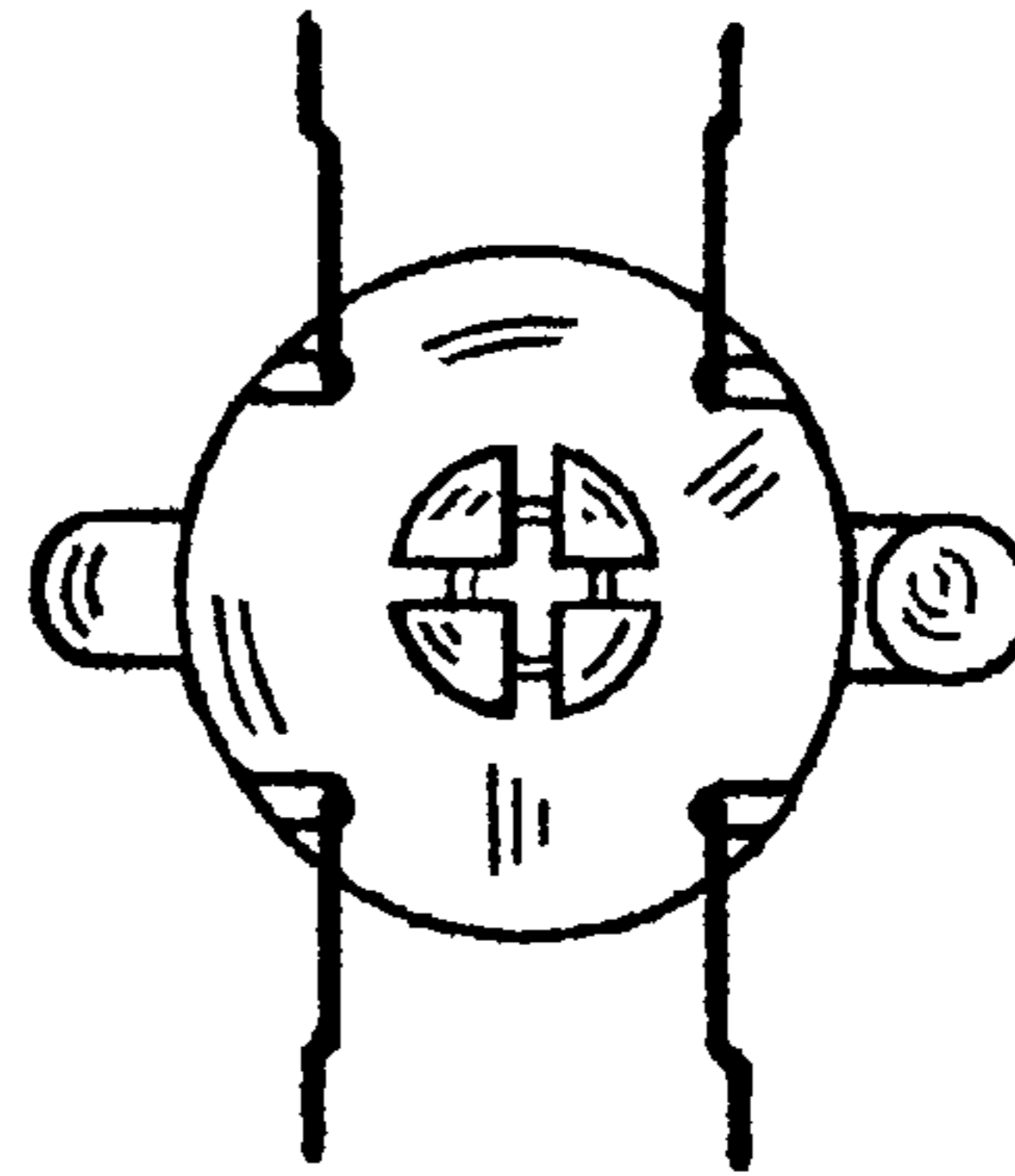
**FIG. 37**



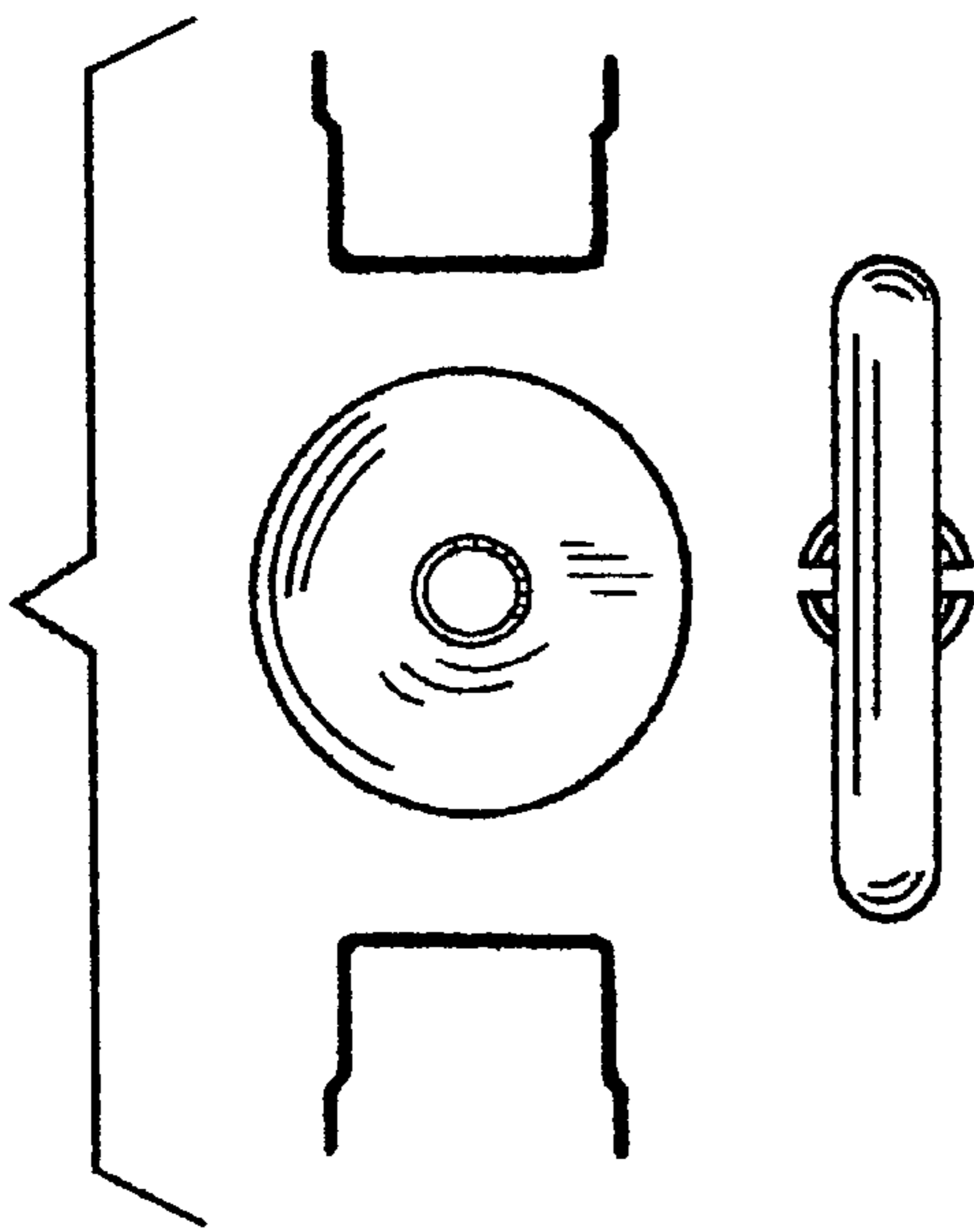
**FIG. 38**



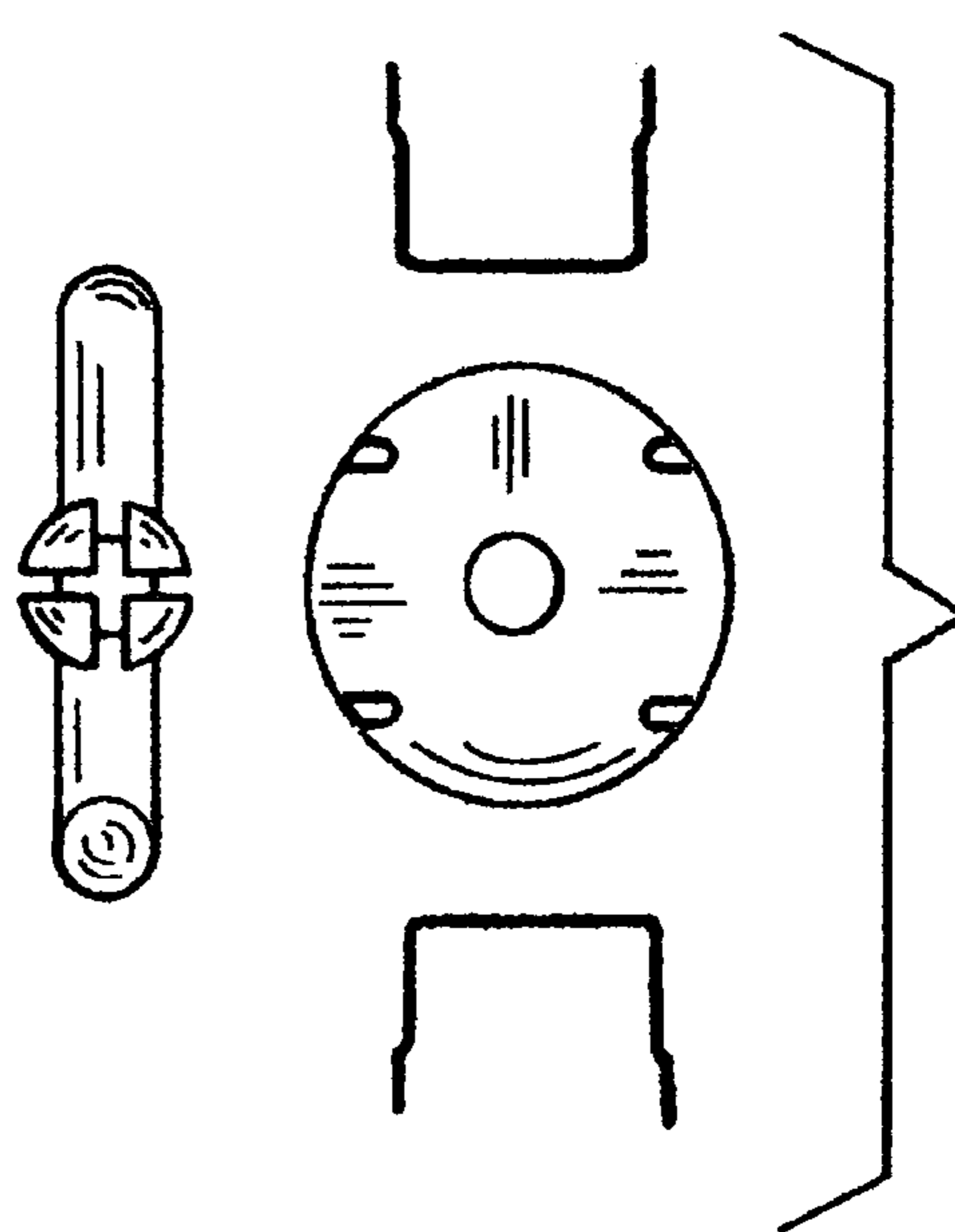
**FIG. 39**



**FIG. 40**

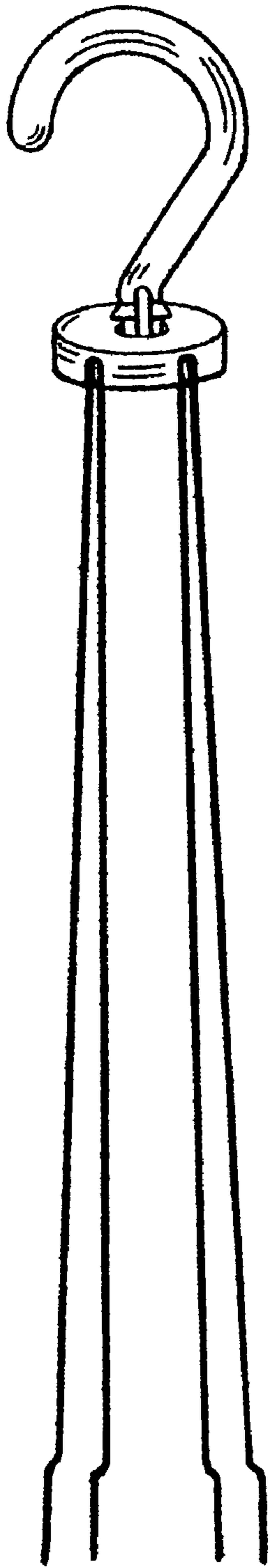


**FIG. 41**

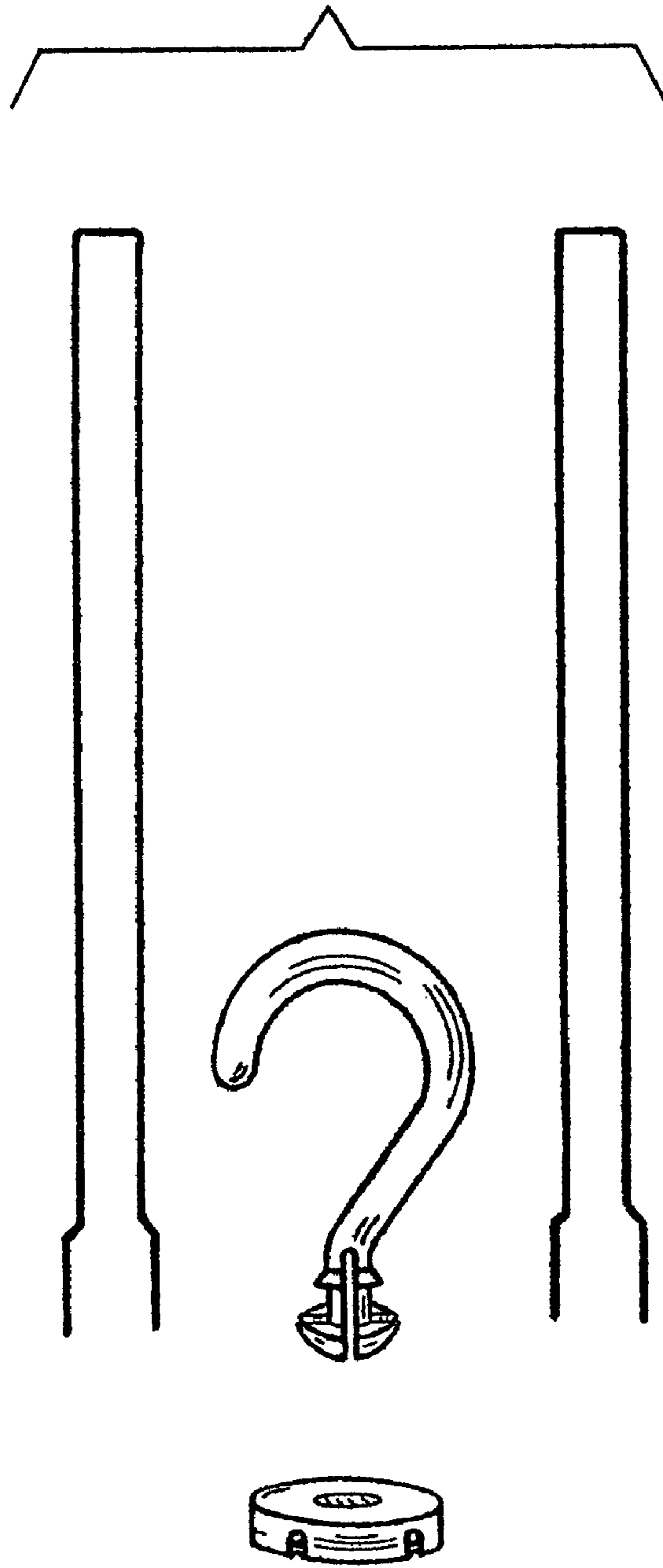


**FIG. 42**

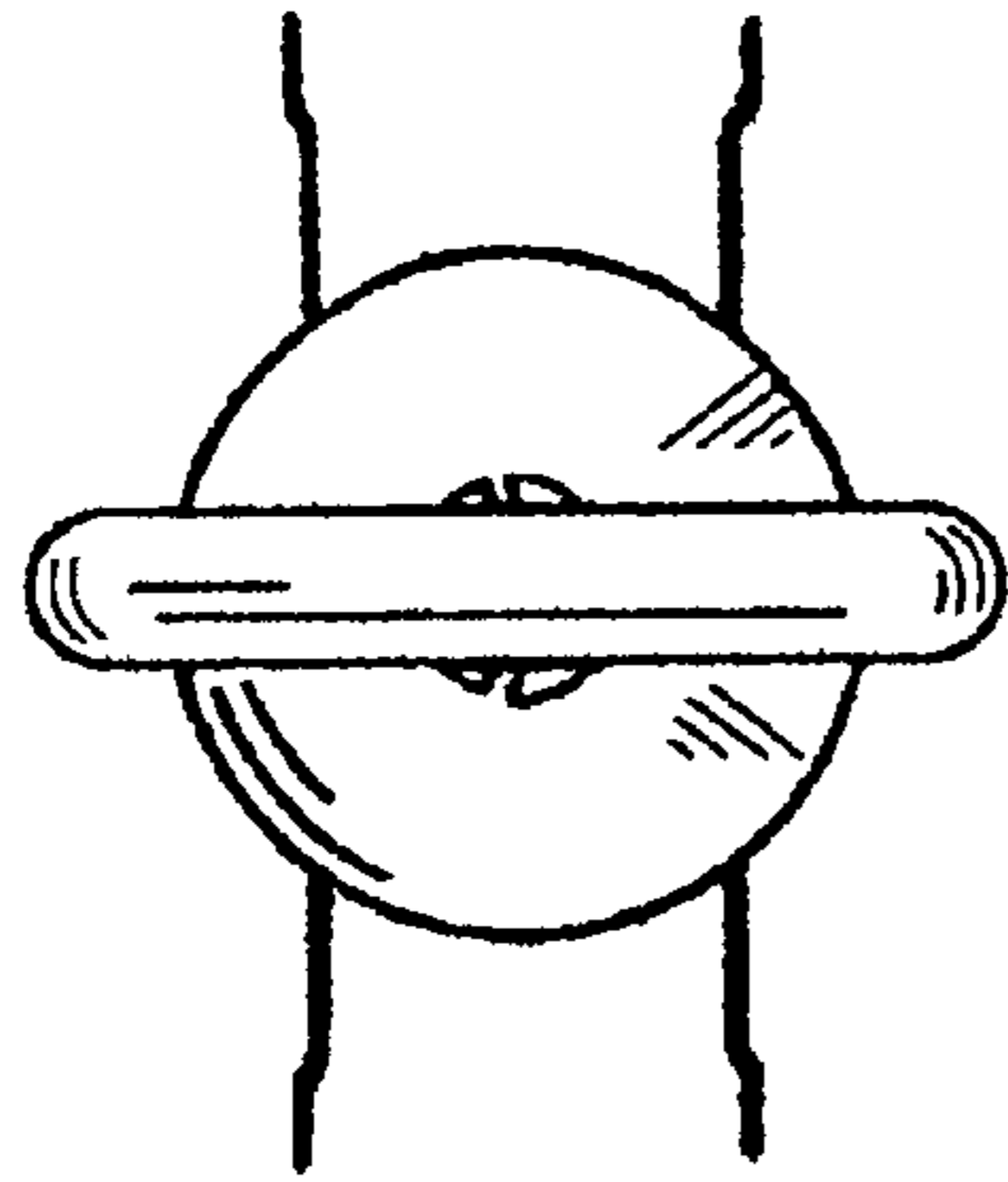




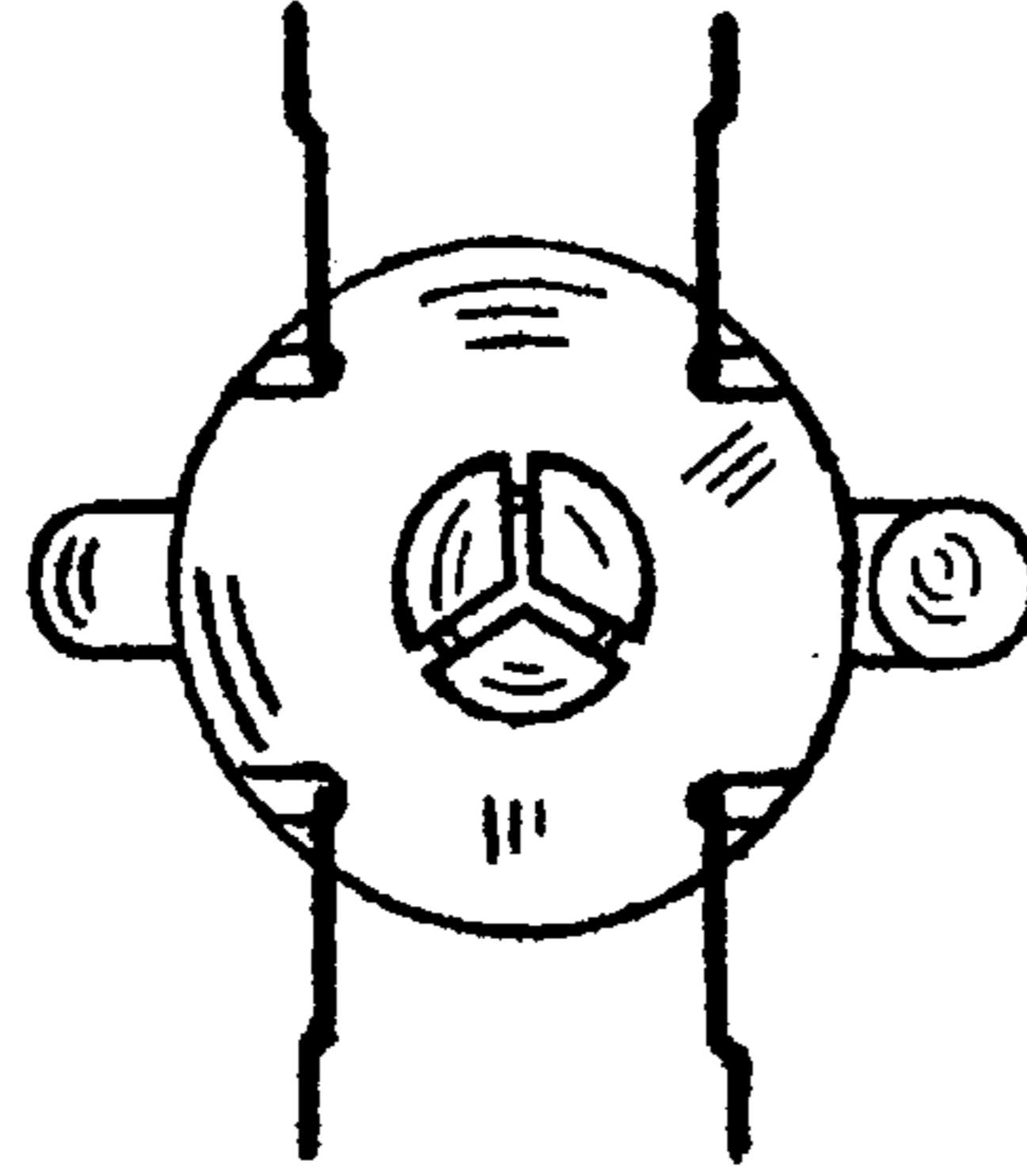
**FIG. 43**



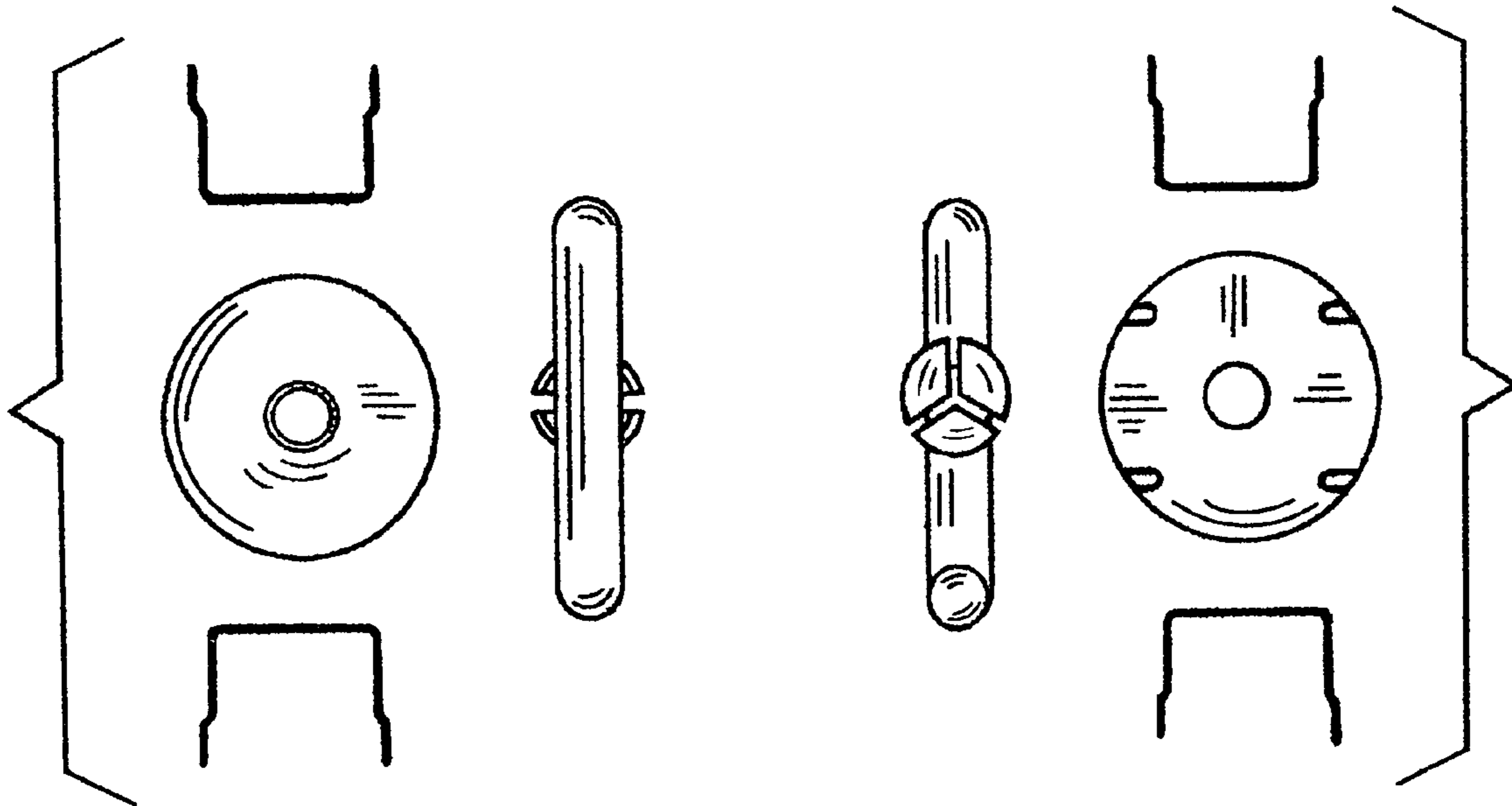
**FIG. 44**



**FIG. 45**

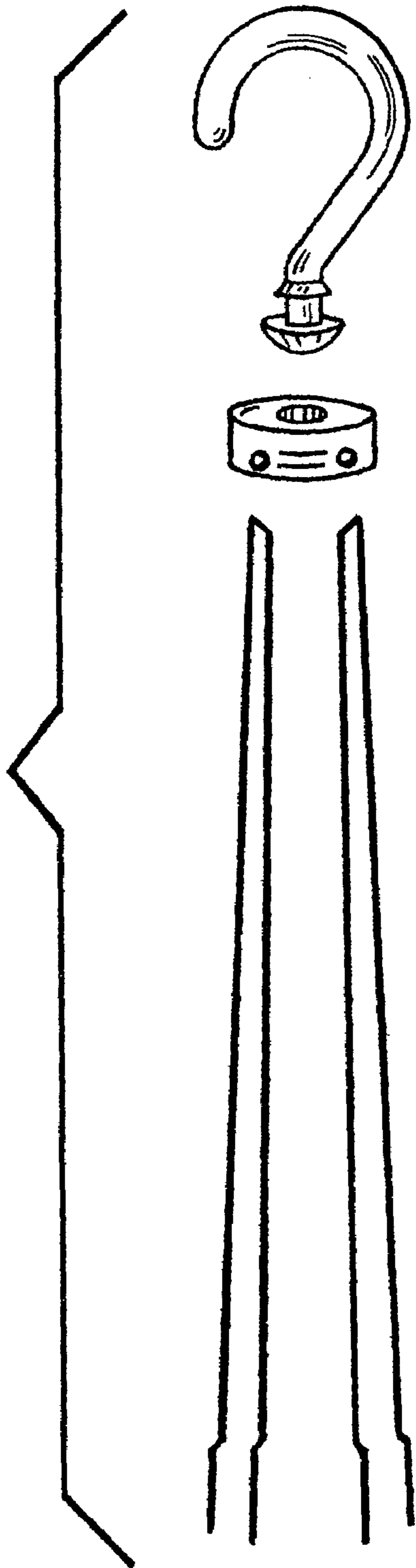


**FIG. 46**

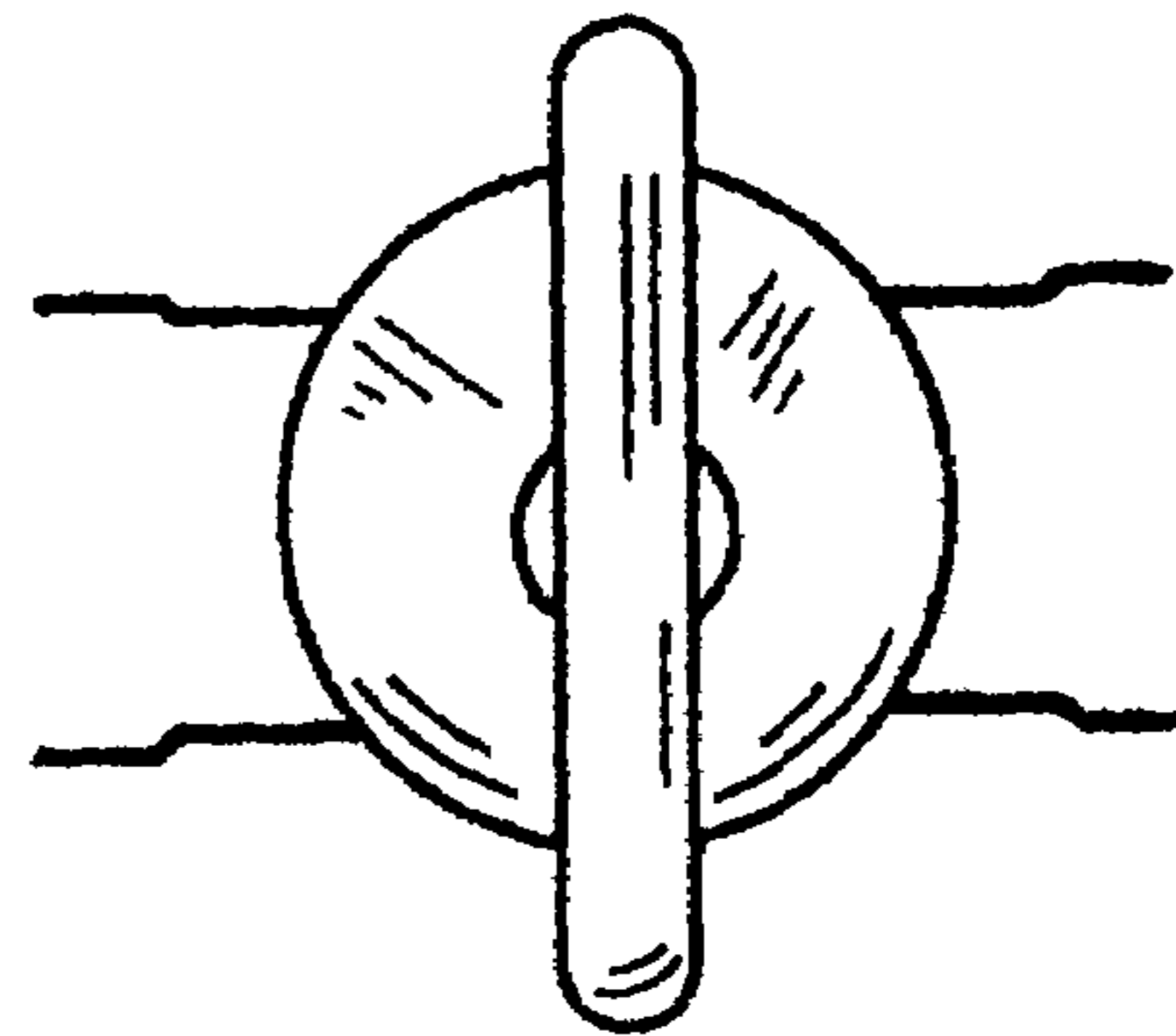


**FIG. 47**

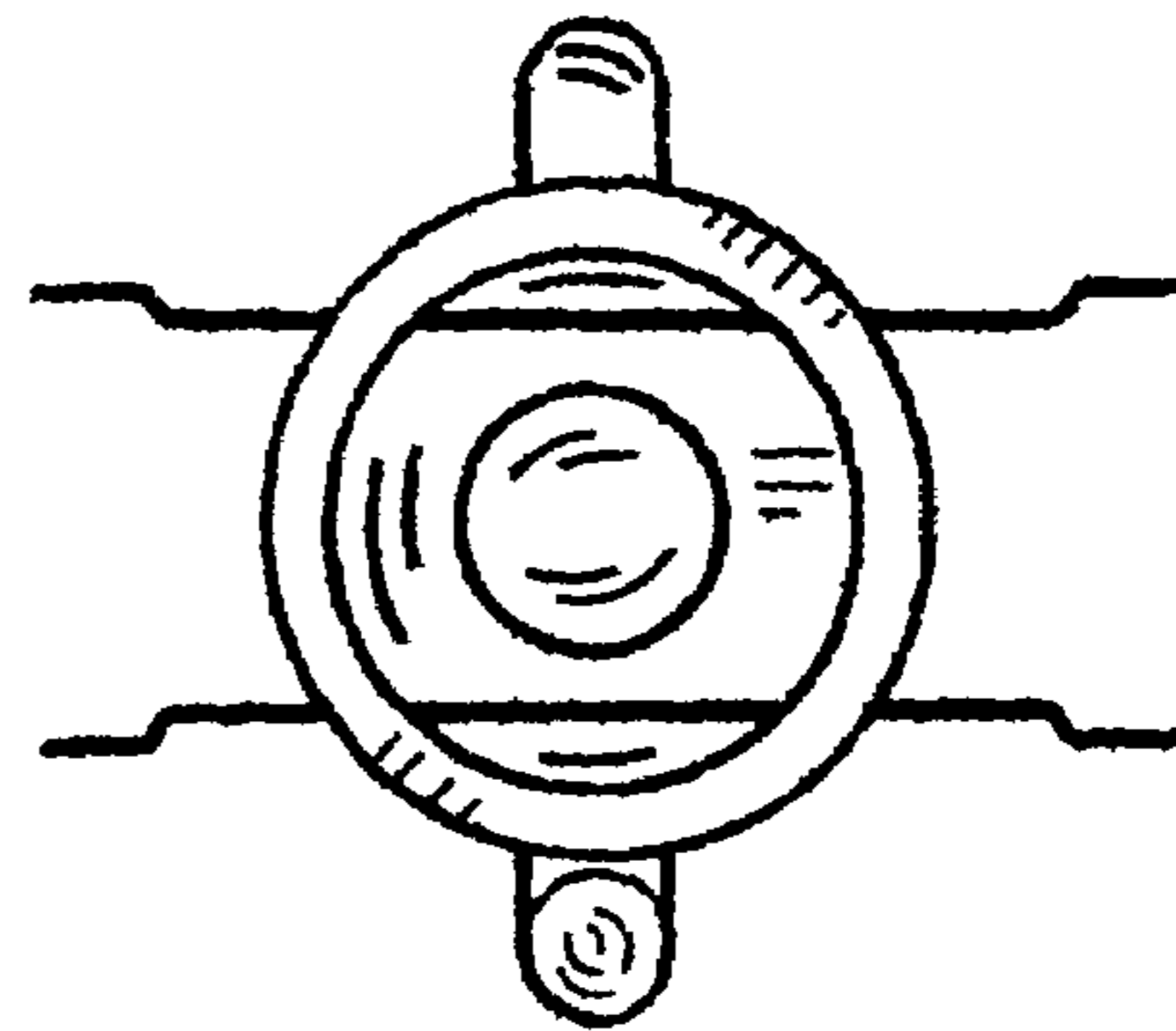
**FIG. 48**



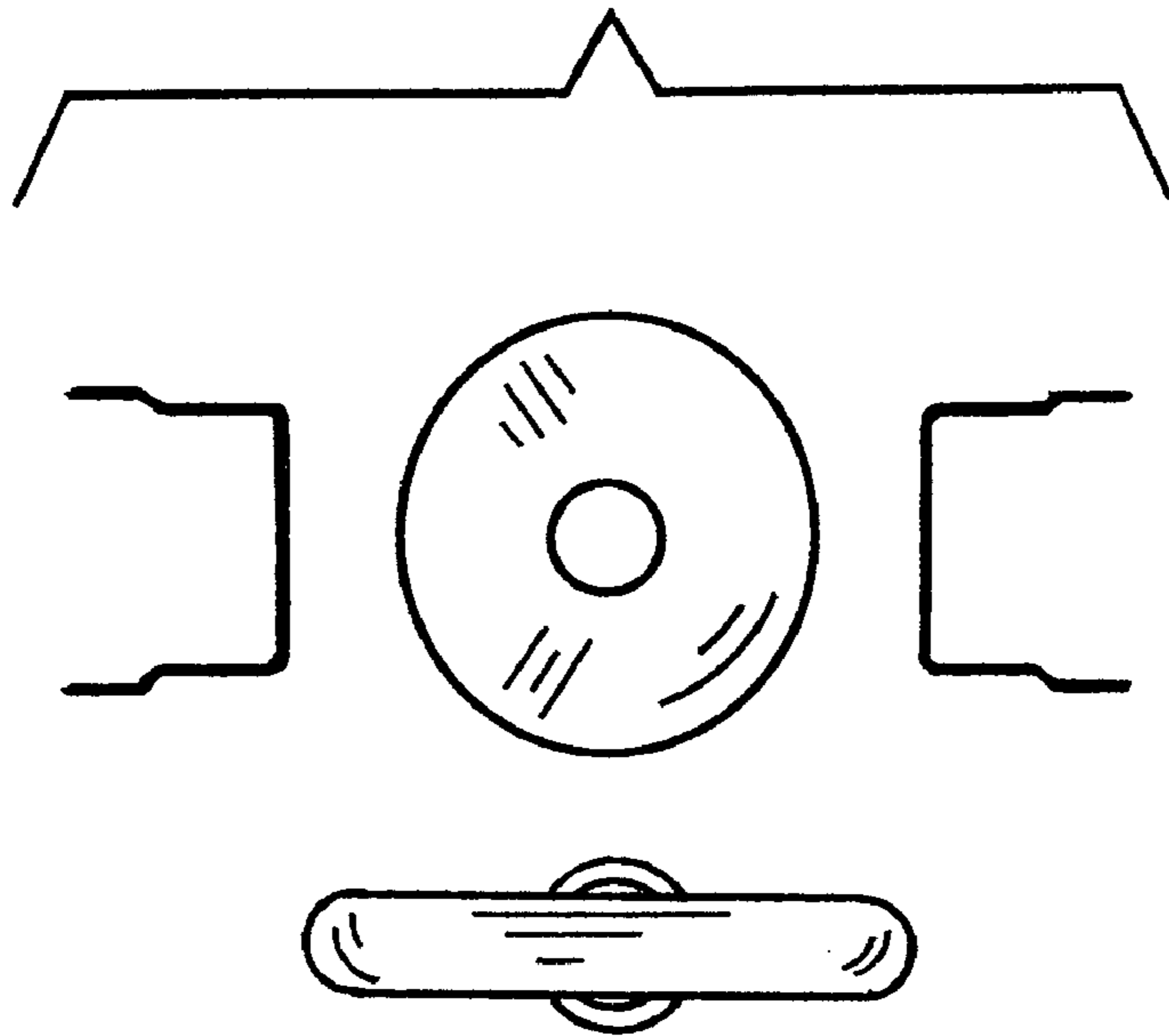
**FIG. 49**



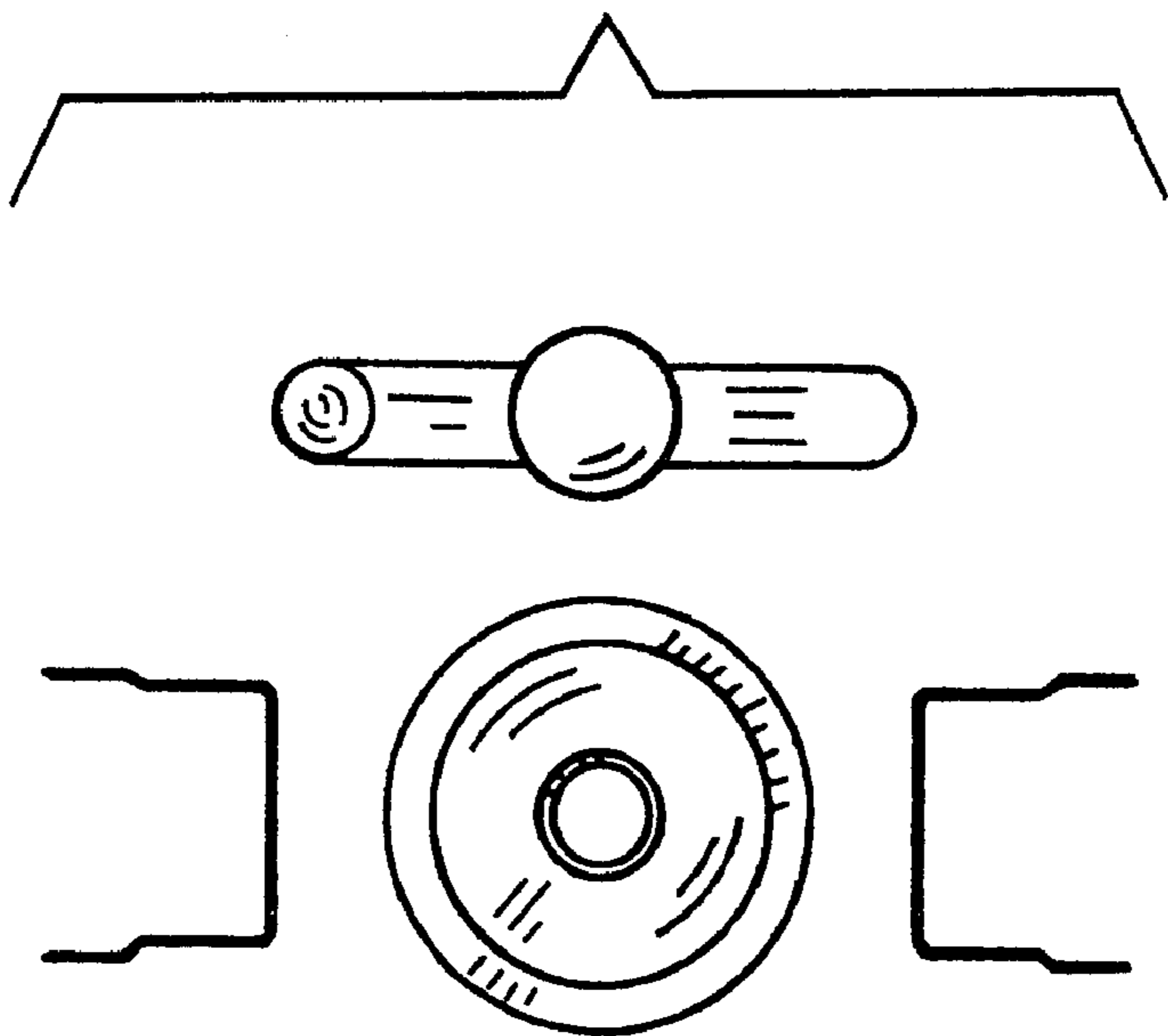
**FIG. 50**



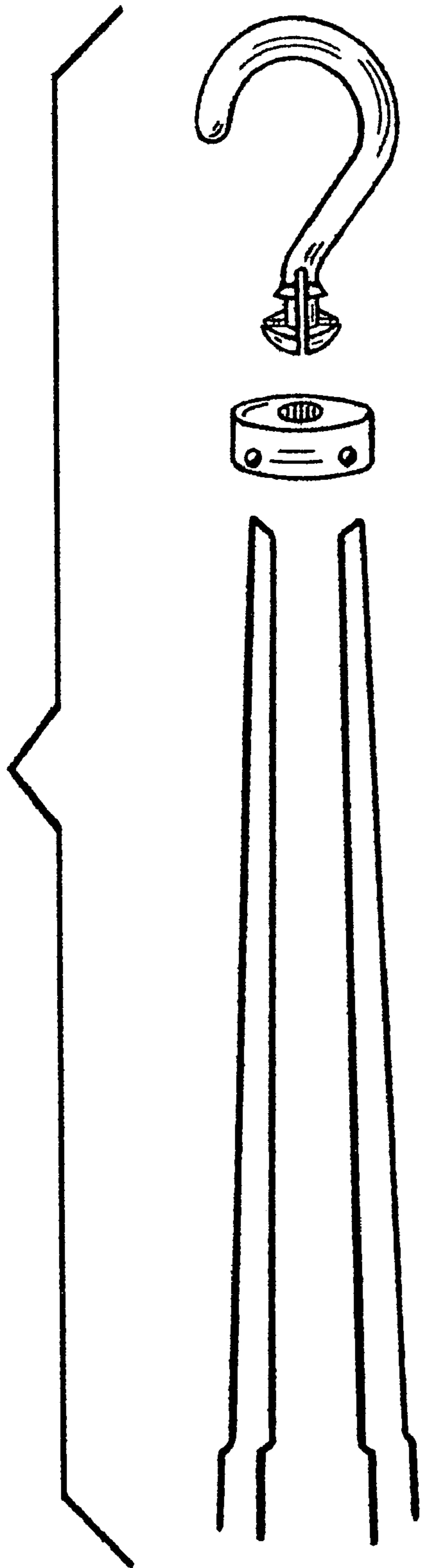
**FIG. 51**



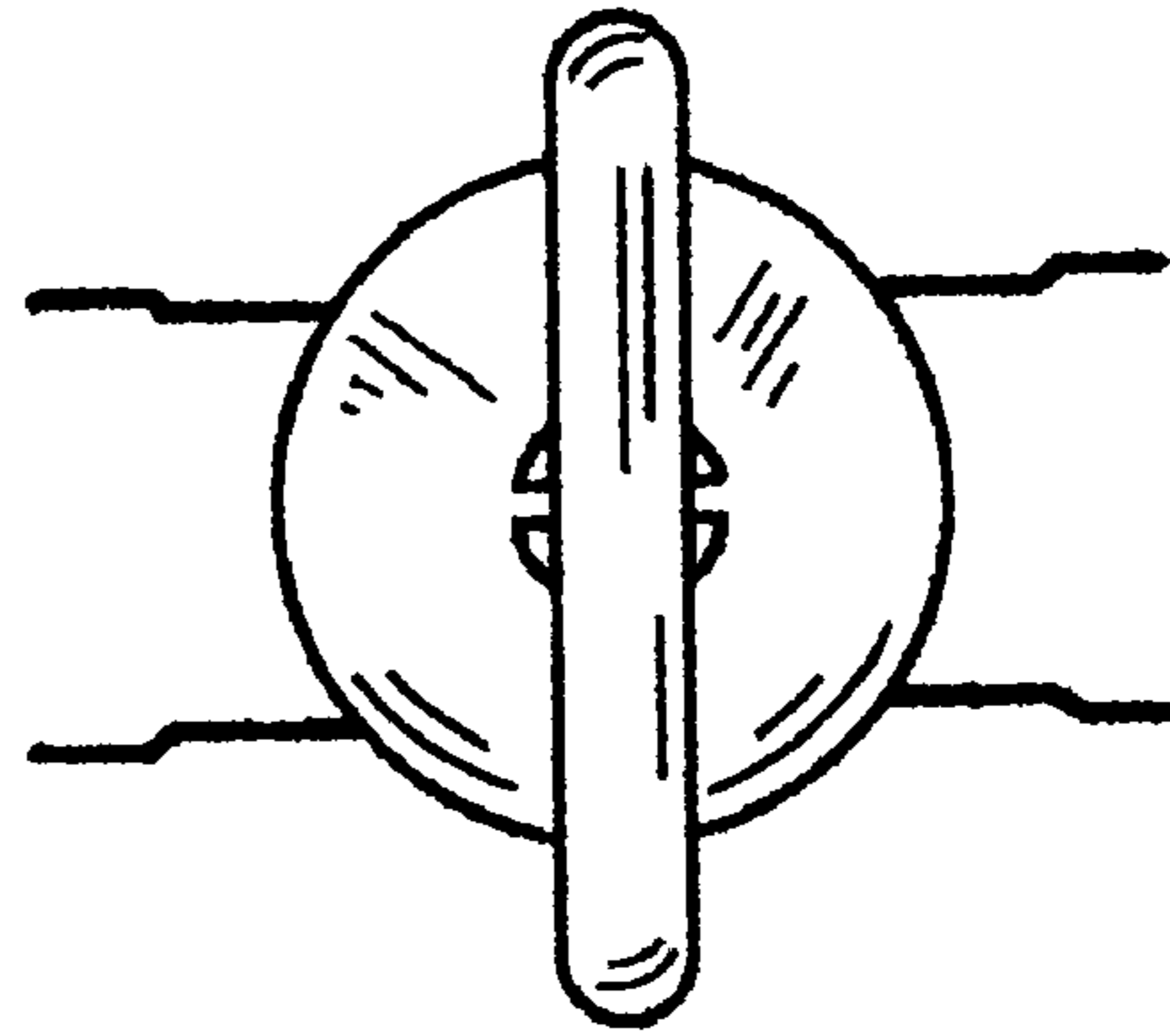
**FIG. 52**



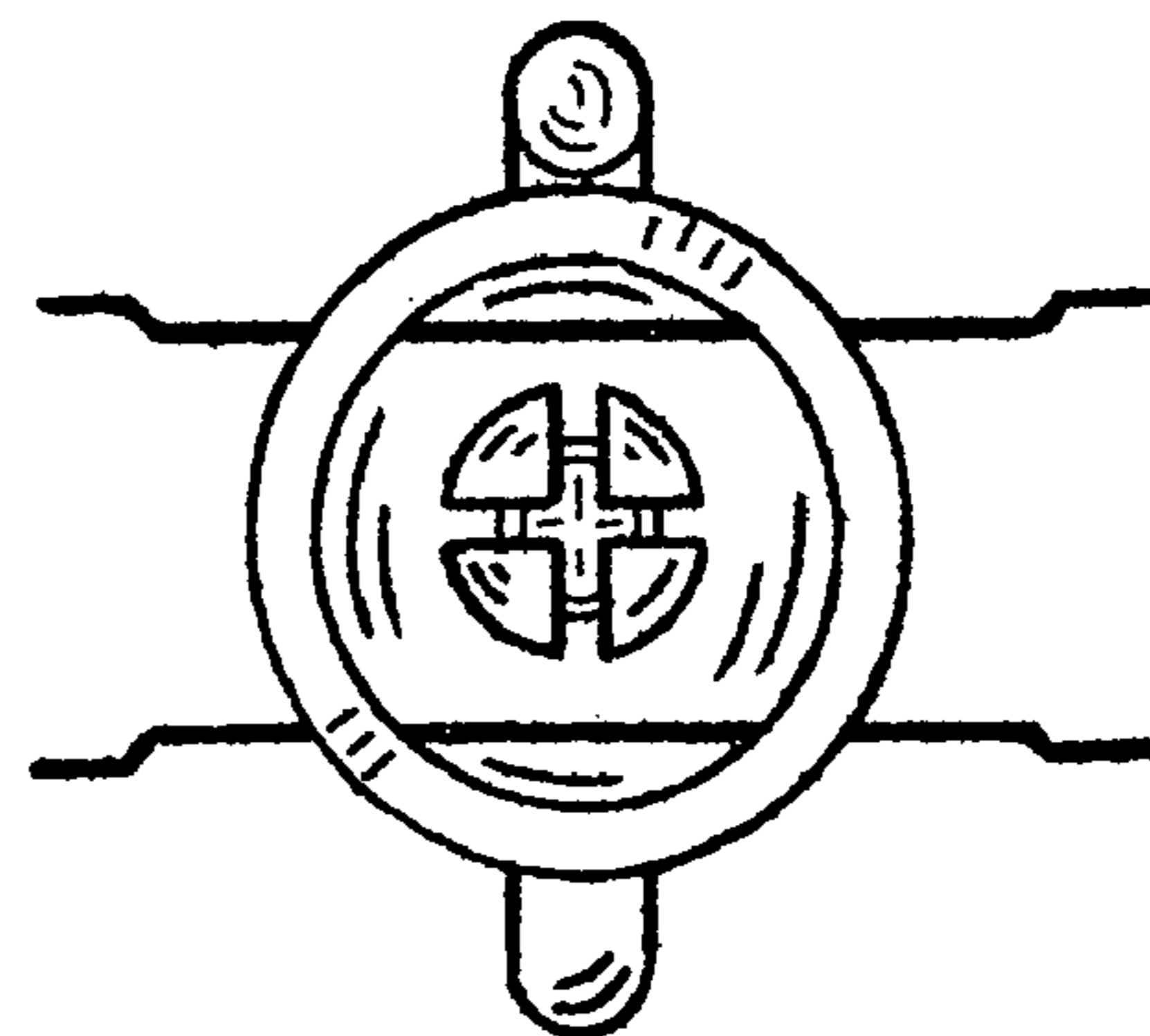
**FIG. 53**



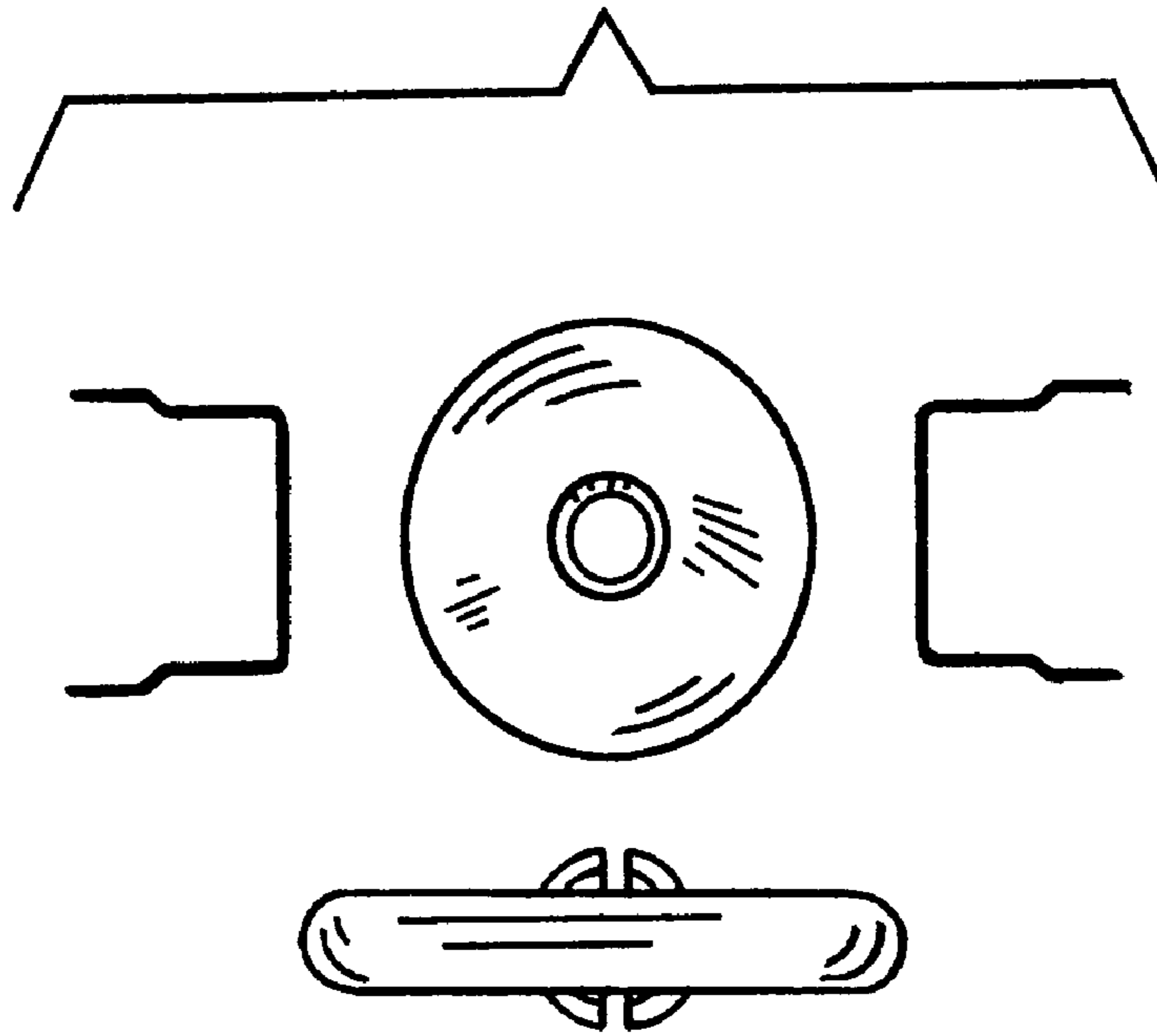
**FIG. 54**



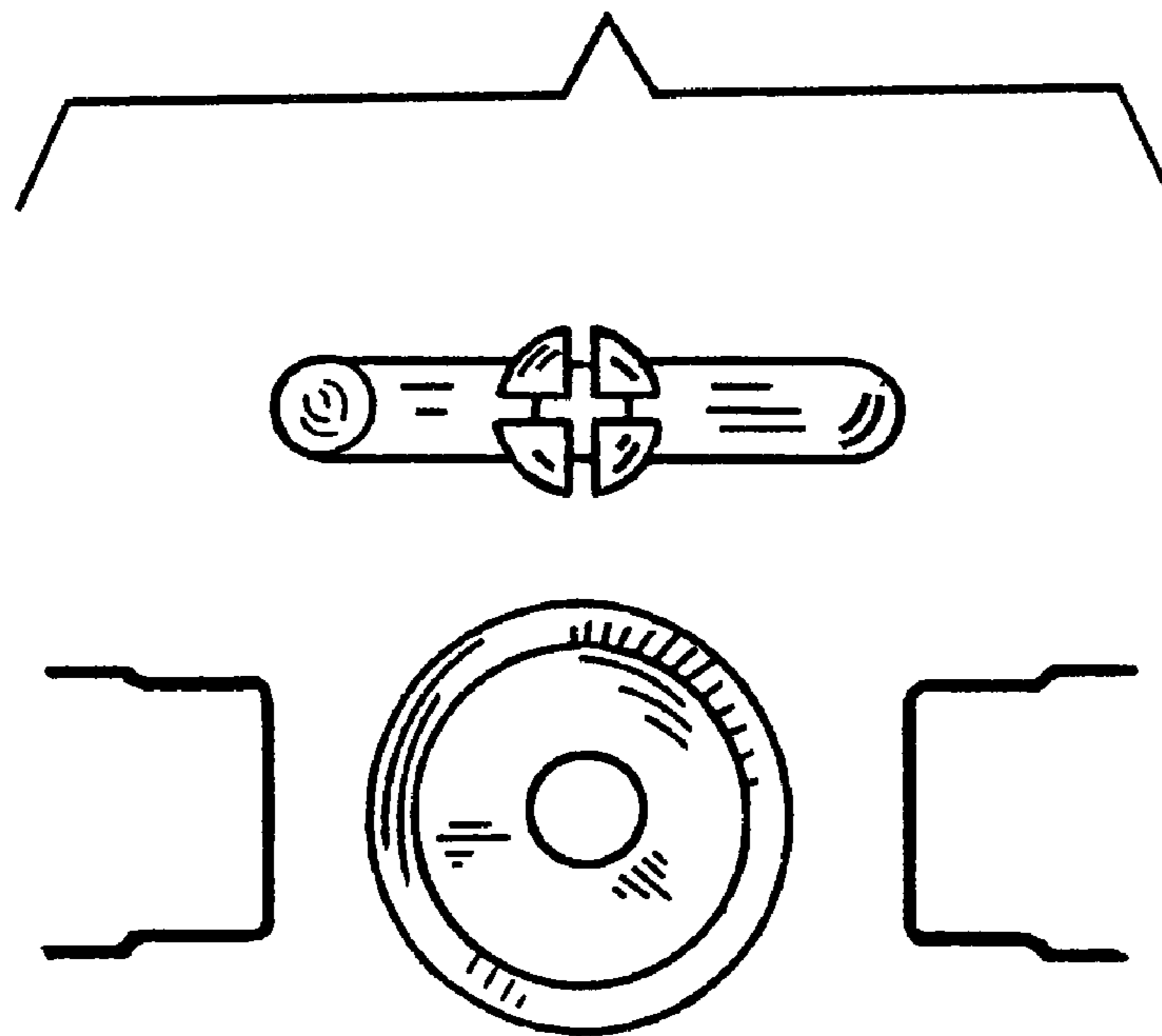
**FIG. 55**



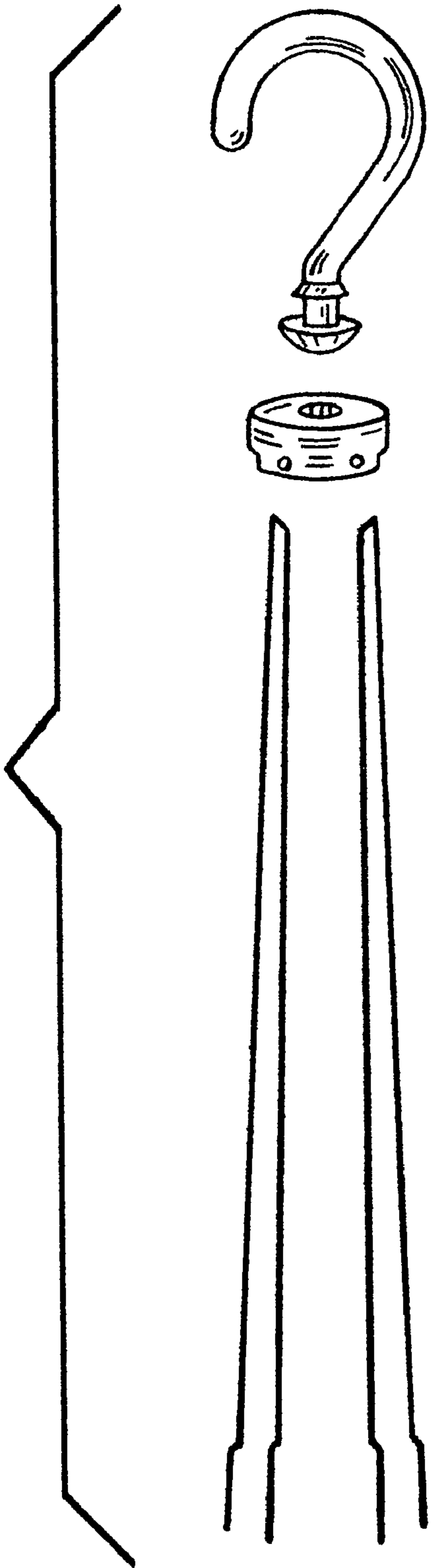
**FIG. 56**



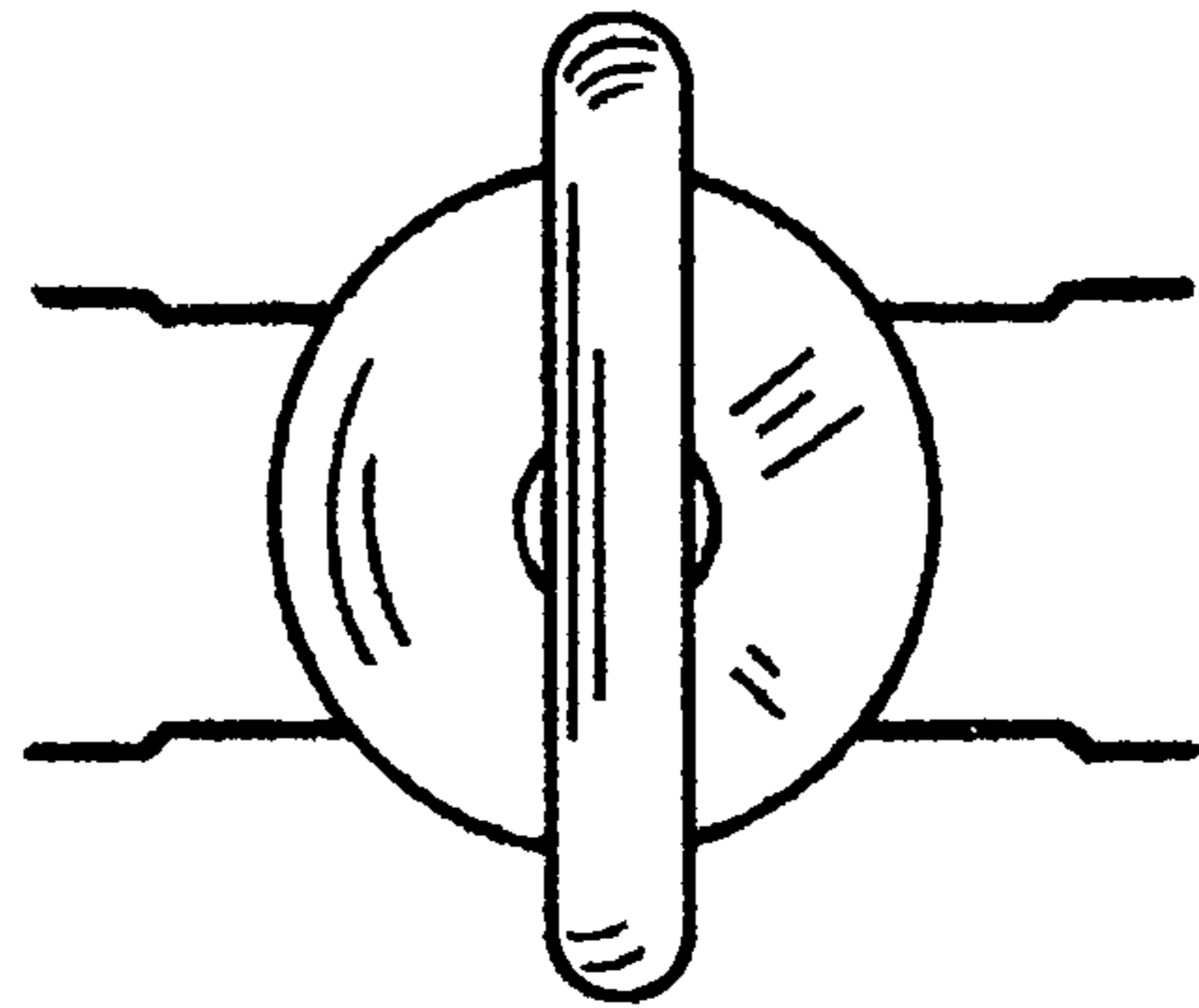
**FIG. 57**



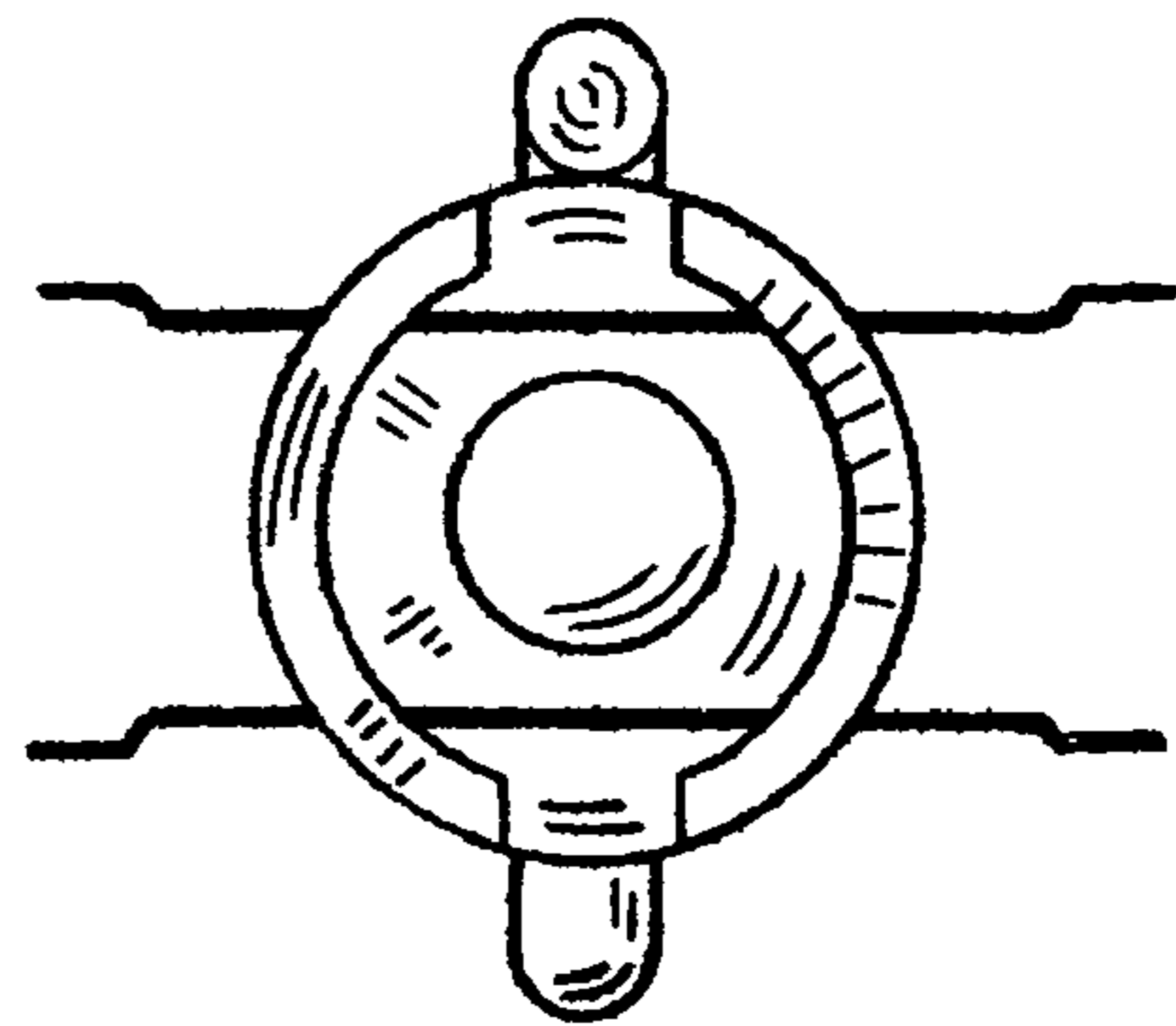
**FIG. 58**



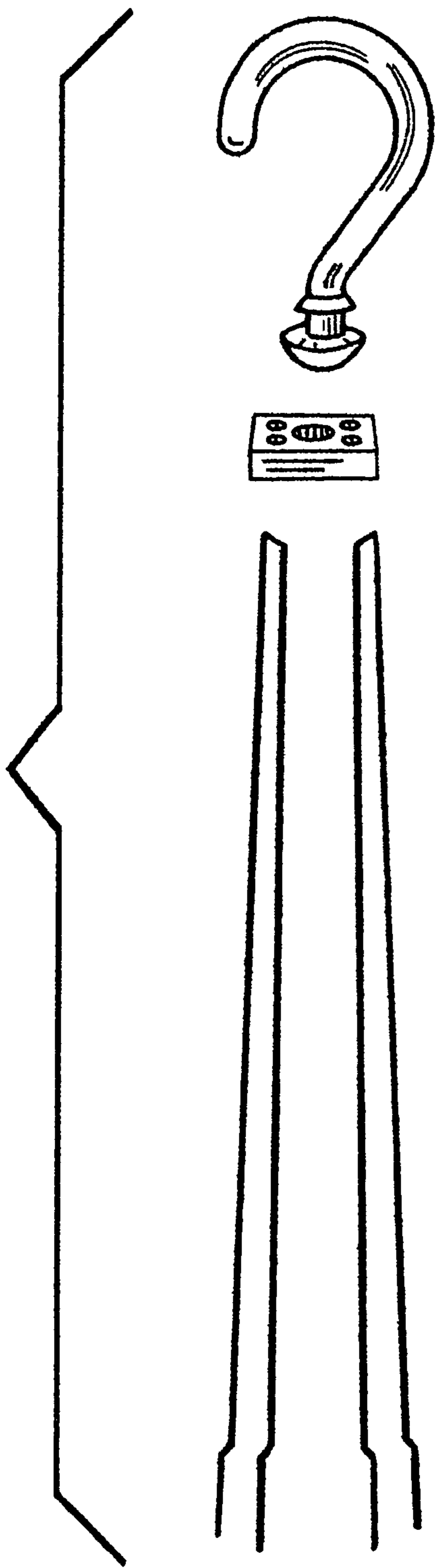
**FIG. 59**



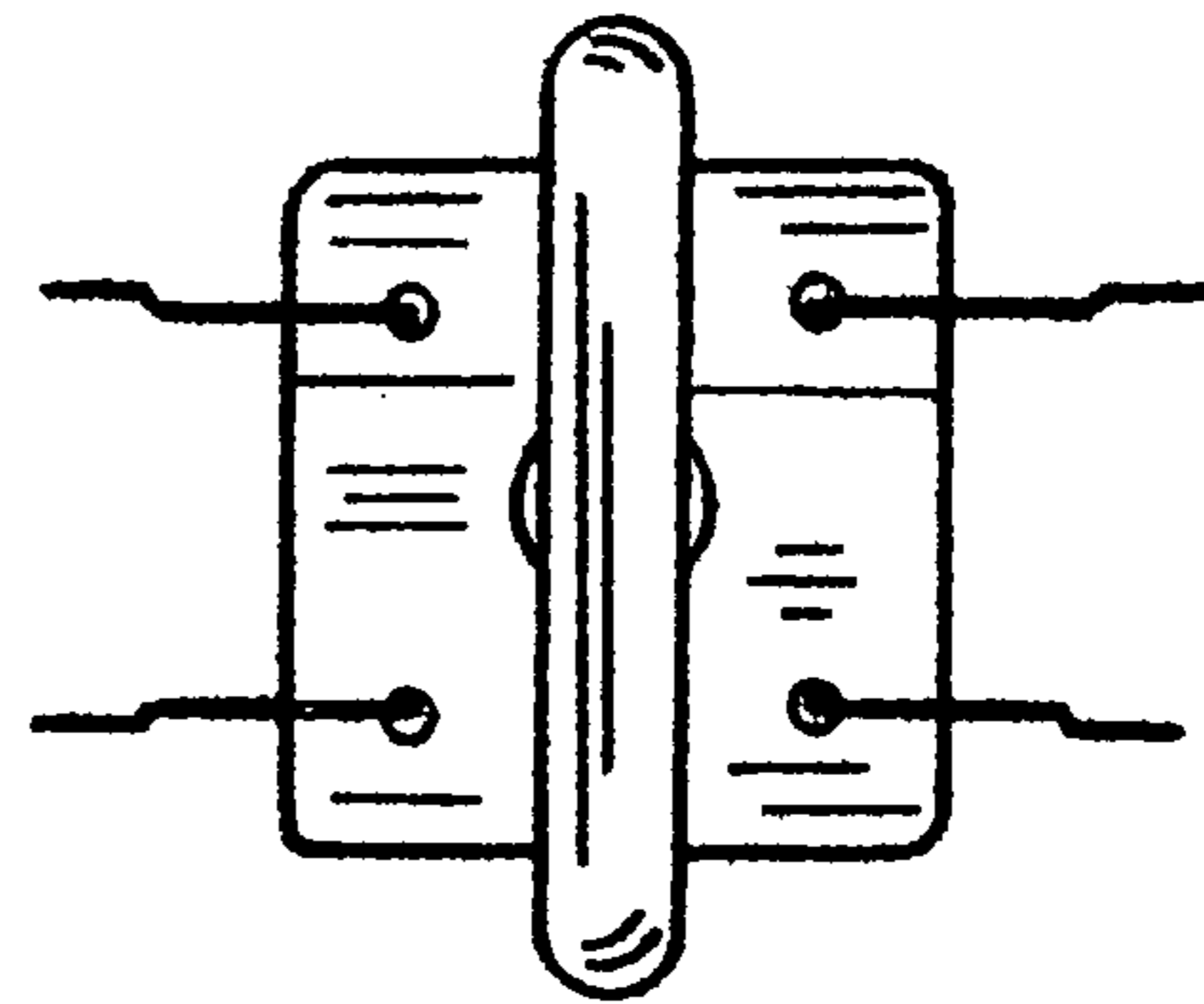
**FIG. 60**



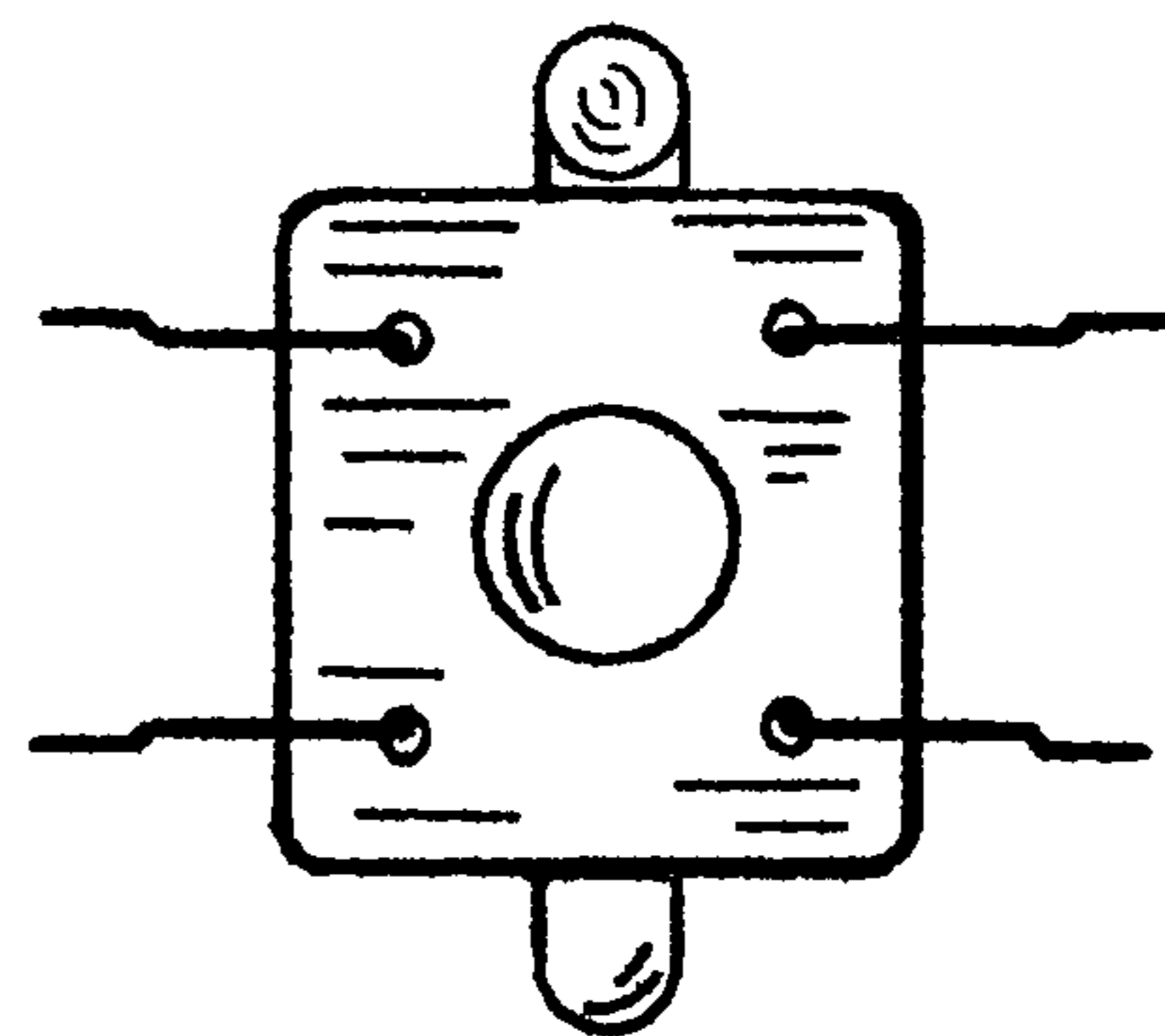
**FIG. 61**



**FIG. 62**

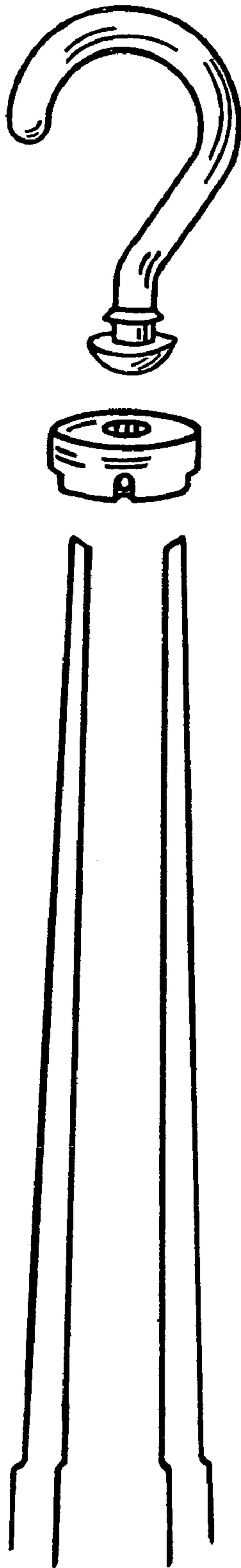


**FIG. 63**

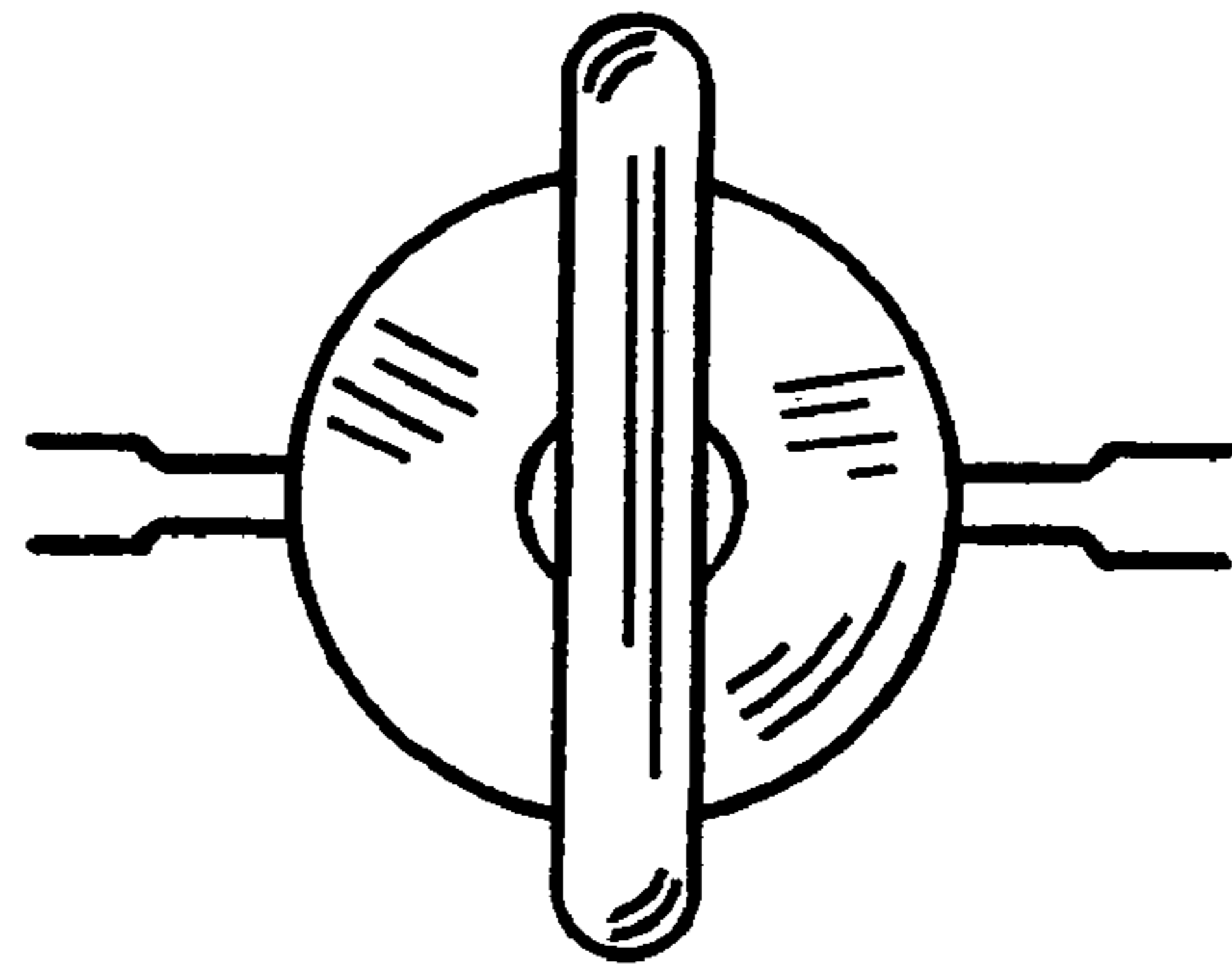


**FIG. 64**

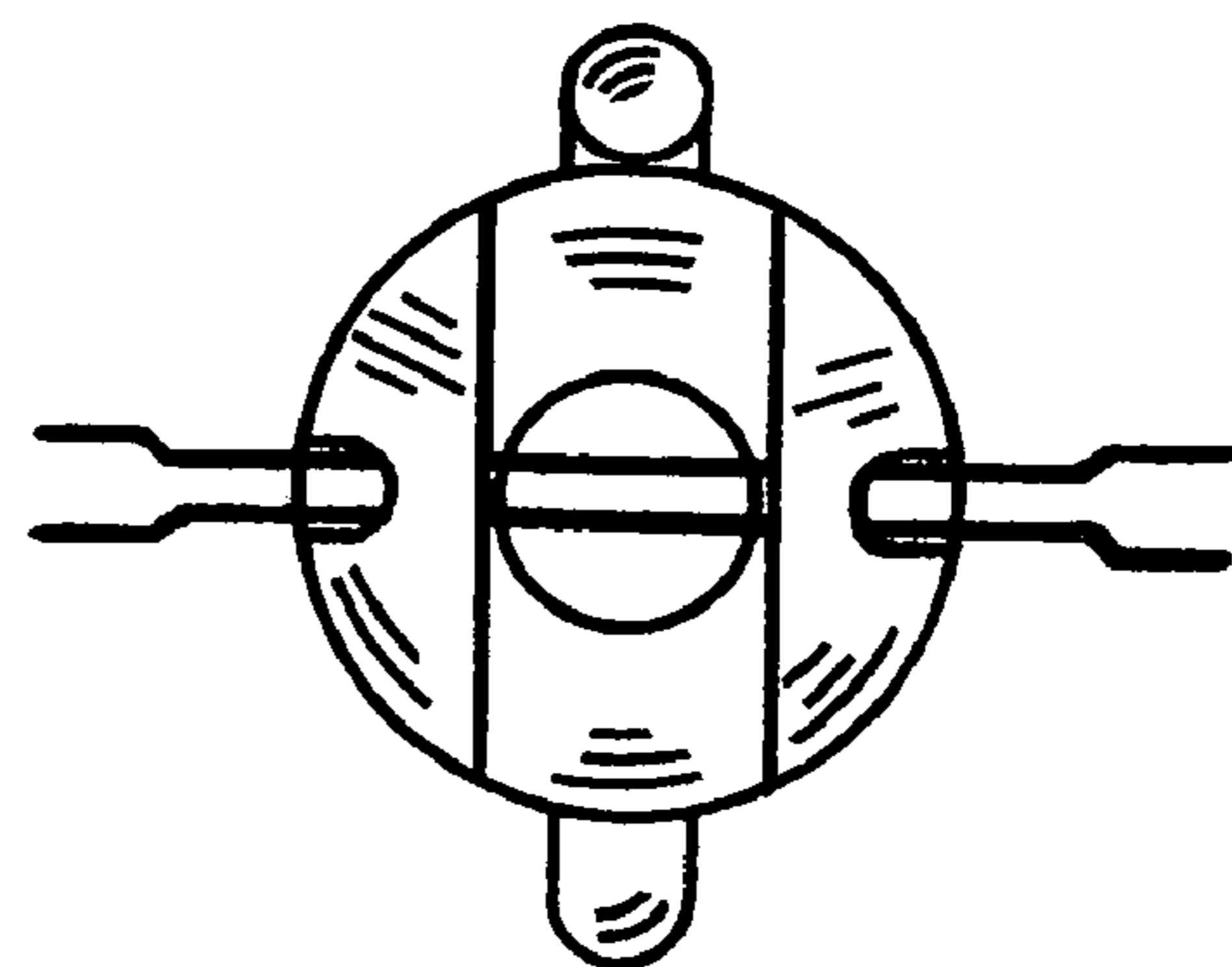




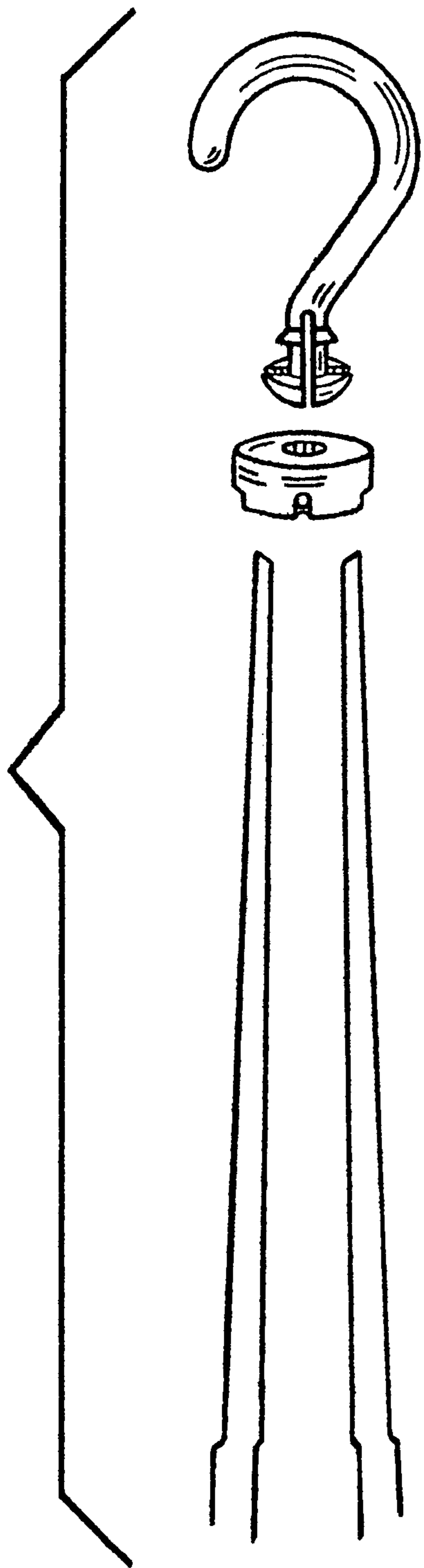
**FIG. 65**



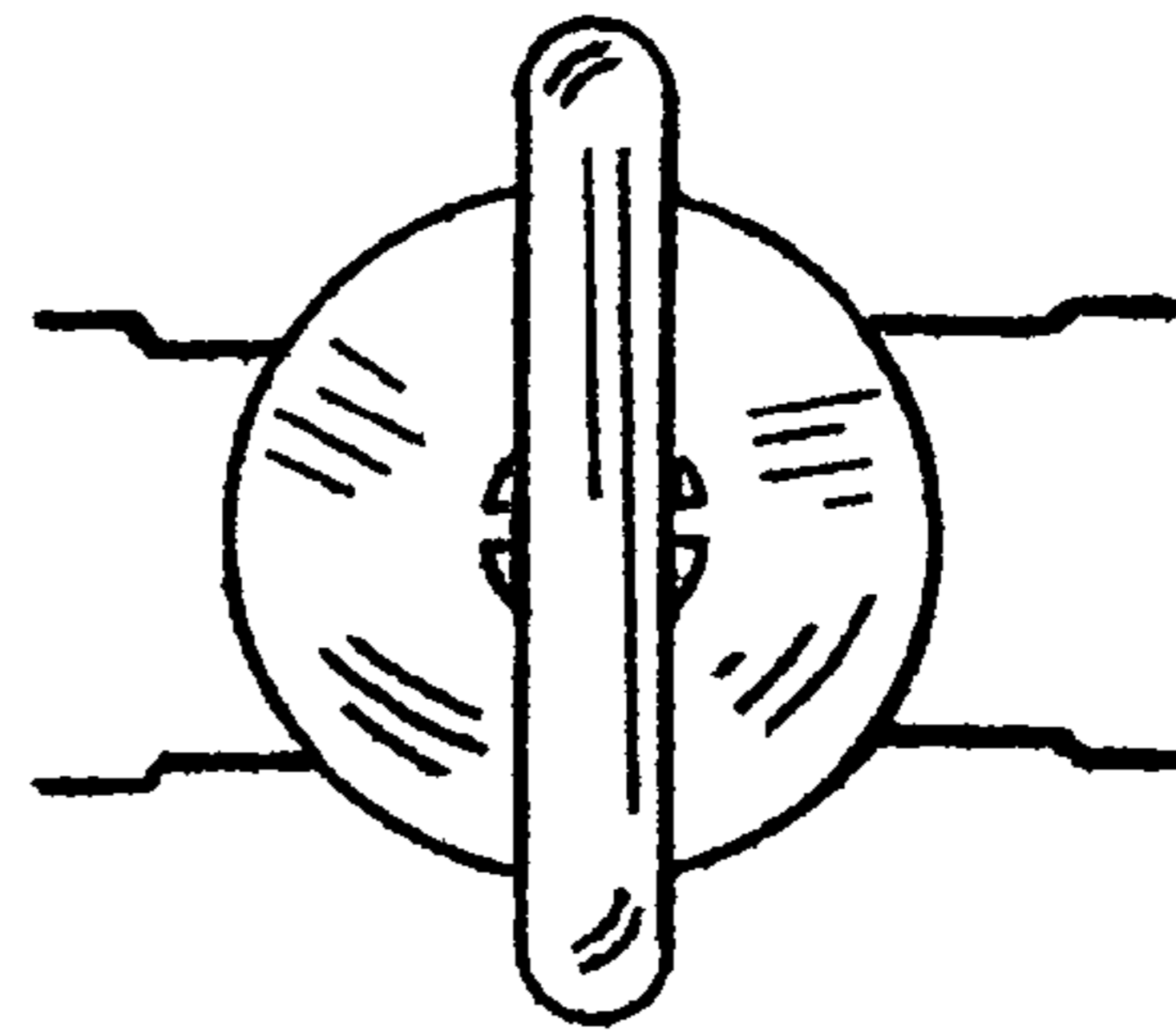
**FIG. 66**



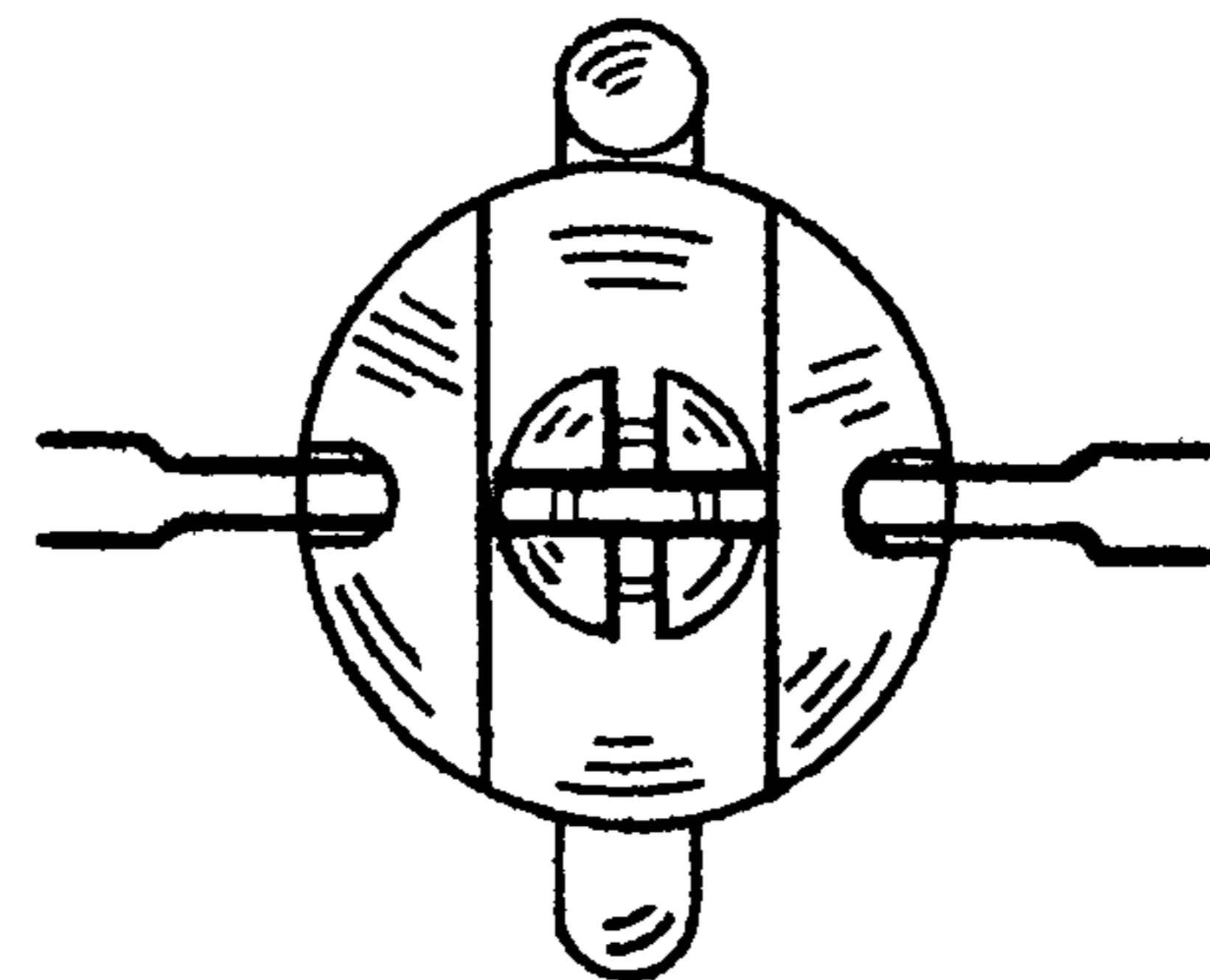
**FIG. 67**



**FIG. 68**



**FIG. 69**



**FIG. 70**