

US00D566601S

(12) **United States Design Patent**
Jones

(10) **Patent No.:** **US D566,601 S**
(45) **Date of Patent:** **** Apr. 15, 2008**

(54) **FIRE ALARM SOUNDER**

(75) Inventor: **Vivian T. Jones**, Great Wakering (GB)

(73) Assignee: **Vimpex Limited** (GB)

(**) Term: **14 Years**

(21) Appl. No.: **29/292,952**

(22) Filed: **Nov. 2, 2007**

Related U.S. Application Data

(62) Division of application No. 29/241,907, filed on Nov. 2, 2005.

(30) **Foreign Application Priority Data**

May 9, 2005	(EM)	000343199-0001
May 9, 2005	(EM)	000343199-0002
May 9, 2005	(EM)	000343199-0003
May 9, 2005	(EM)	000343199-0004

(51) **LOC (8) Cl.** **10-05**

(52) **U.S. Cl.** **D10/106**

(58) **Field of Classification Search** D10/104,
D10/116, 121; 340/287, 562; 439/709;
D13/158, 168

See application file for complete search history.

(56) **References Cited**

U.S. PATENT DOCUMENTS

D144,235	S *	3/1946	Brass	D10/106
3,253,272	A *	5/1966	Schuchard et al.	340/307
D265,802	S *	8/1982	Vickery	D10/118

D276,708	S *	12/1984	Simpson	D10/104
4,551,707	A *	11/1985	Simpson	340/287
D428,351	S *	7/2000	Hohlfelder	D10/106
D429,696	S *	8/2000	Taylor	D13/158
D433,644	S *	11/2000	Sakurai et al.	D10/106
D437,298	S *	2/2001	Picozza et al.	D13/168
D478,832	S *	8/2003	Dipple	D10/106
6,632,108	B1 *	10/2003	Hohlfelder	439/709
6,903,654	B2 *	6/2005	Hansen et al.	340/562
2007/0063821	A1 *	3/2007	Finkle et al.	340/287

* cited by examiner

Primary Examiner—Robert M. Spear

Assistant Examiner—George D Kirschbaum

(74) *Attorney, Agent, or Firm*—Renner Kenner Greive
Bobak Taylor & Weber

(57) **CLAIM**

The ornamental design for a fire alarm sounder, as shown and described.

DESCRIPTION

FIG. 1 is a perspective view of a fire alarm sounder showing my new design;

FIG. 2 is a front elevational view thereof;

FIG. 3 is a side elevational view, the opposite side elevational view being a mirror image thereof;

FIG. 4 is a top plan view thereof;

FIG. 5 is a bottom plan view thereof; and,

FIG. 6 is a rear elevational view thereof.

1 Claim, 3 Drawing Sheets

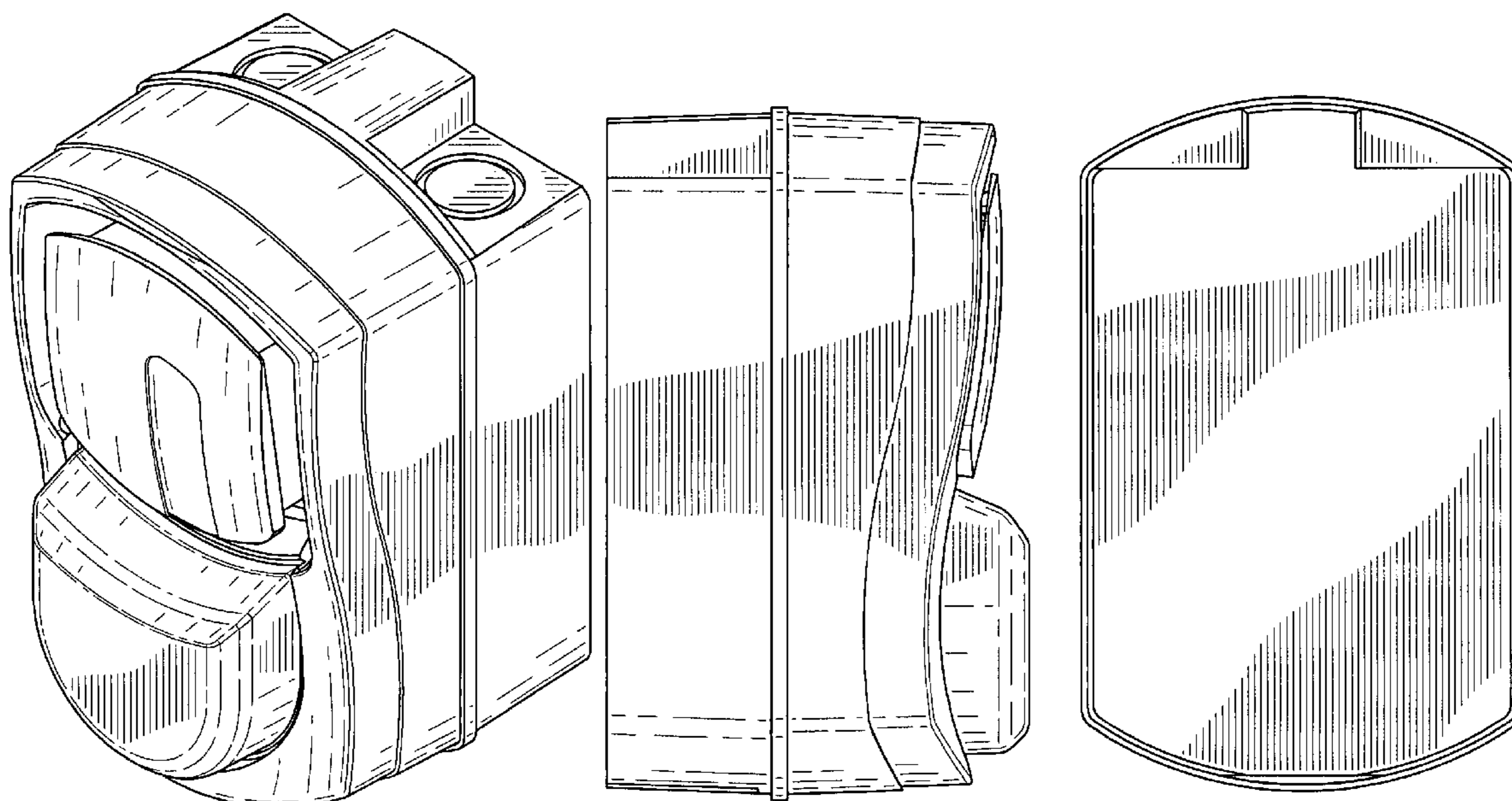

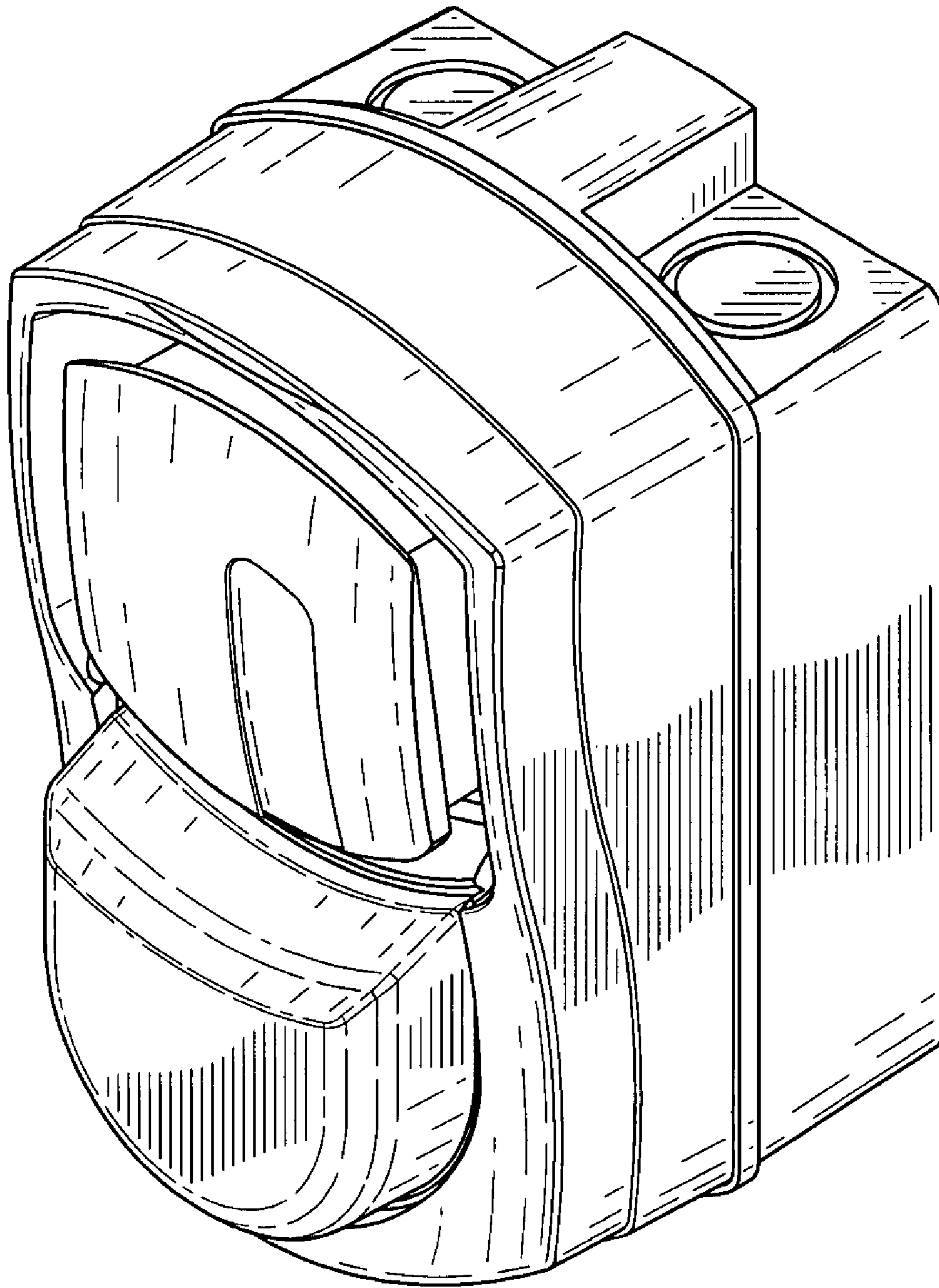

FIG-1

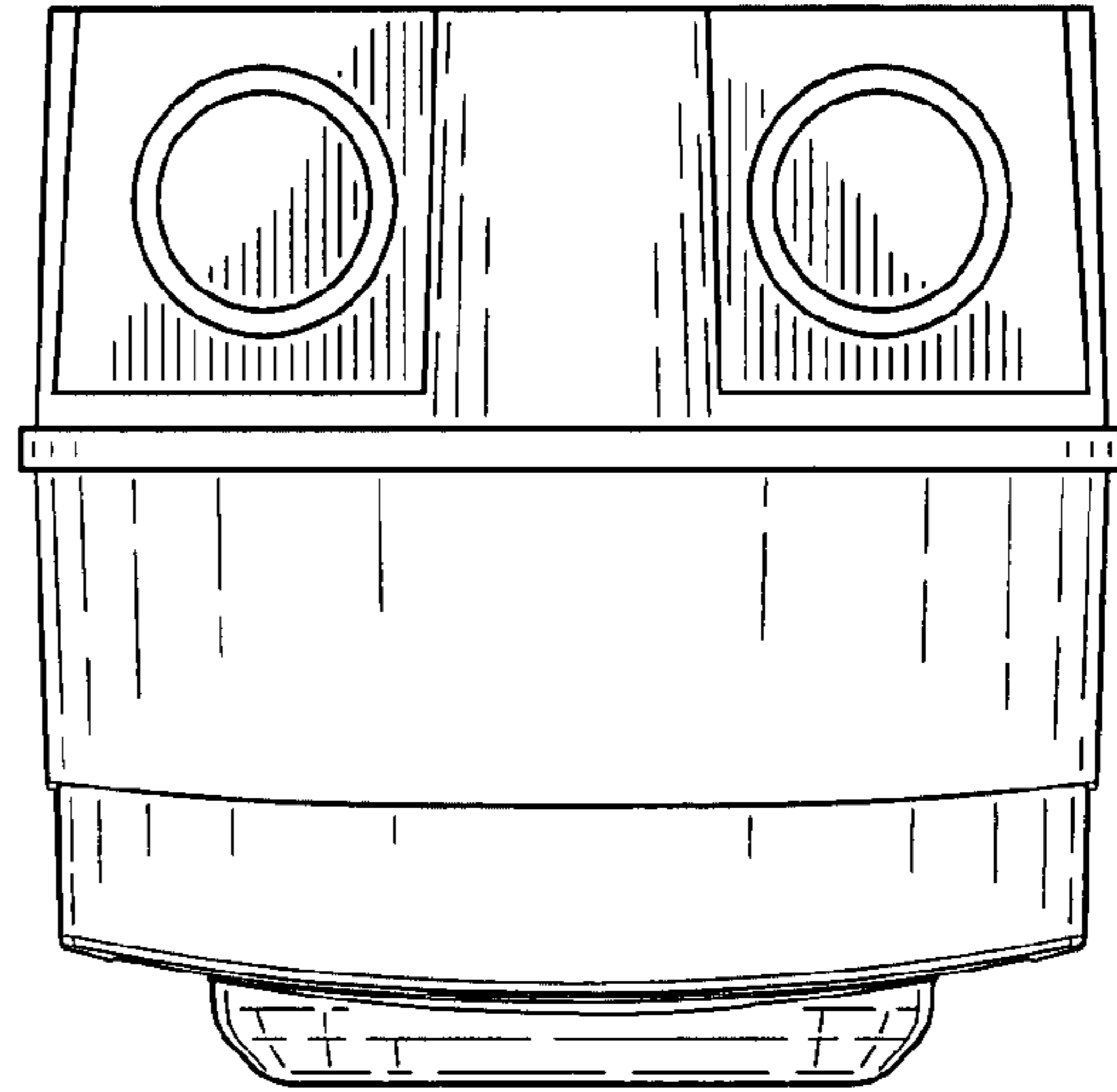

FIG-4

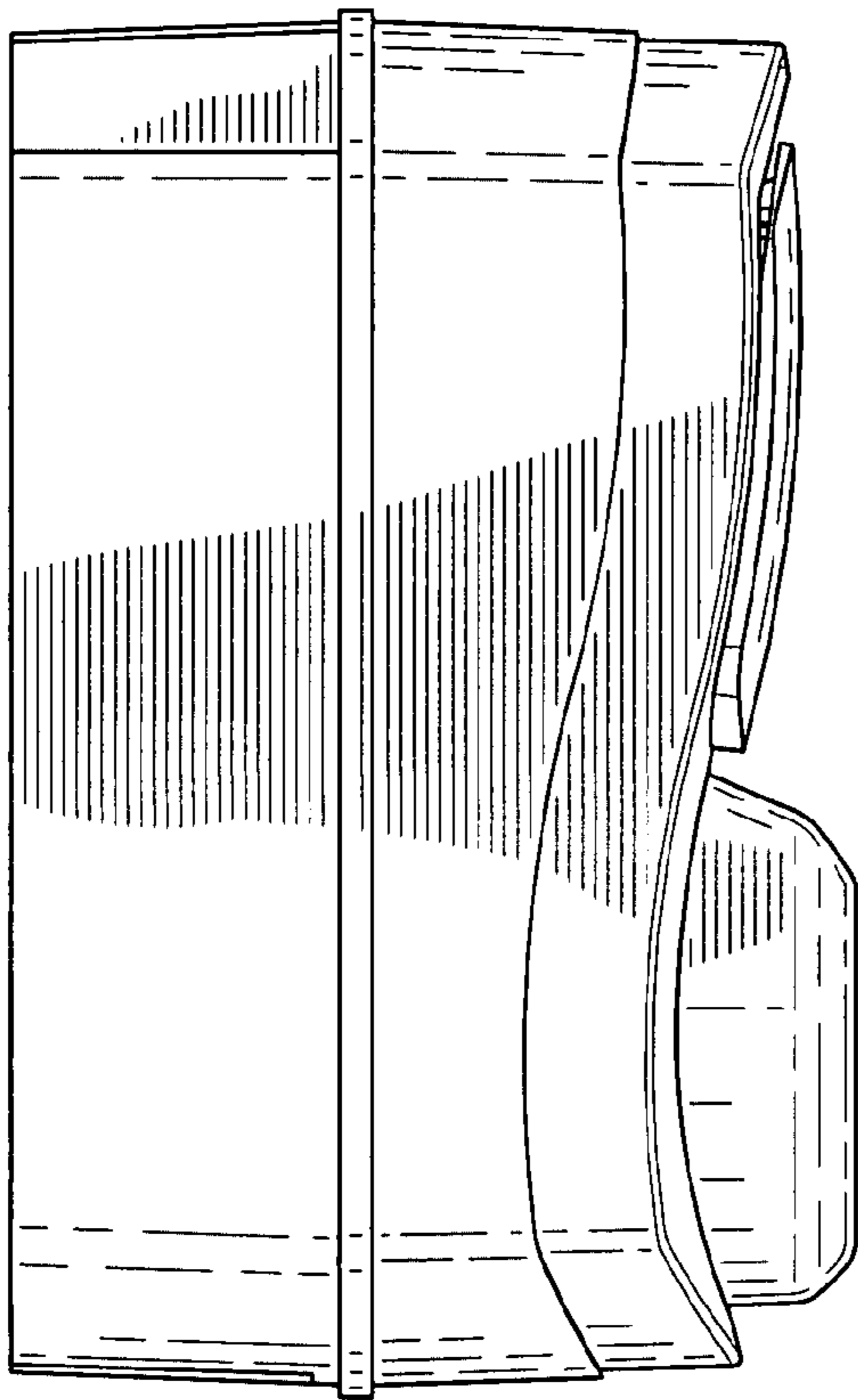

FIG-3

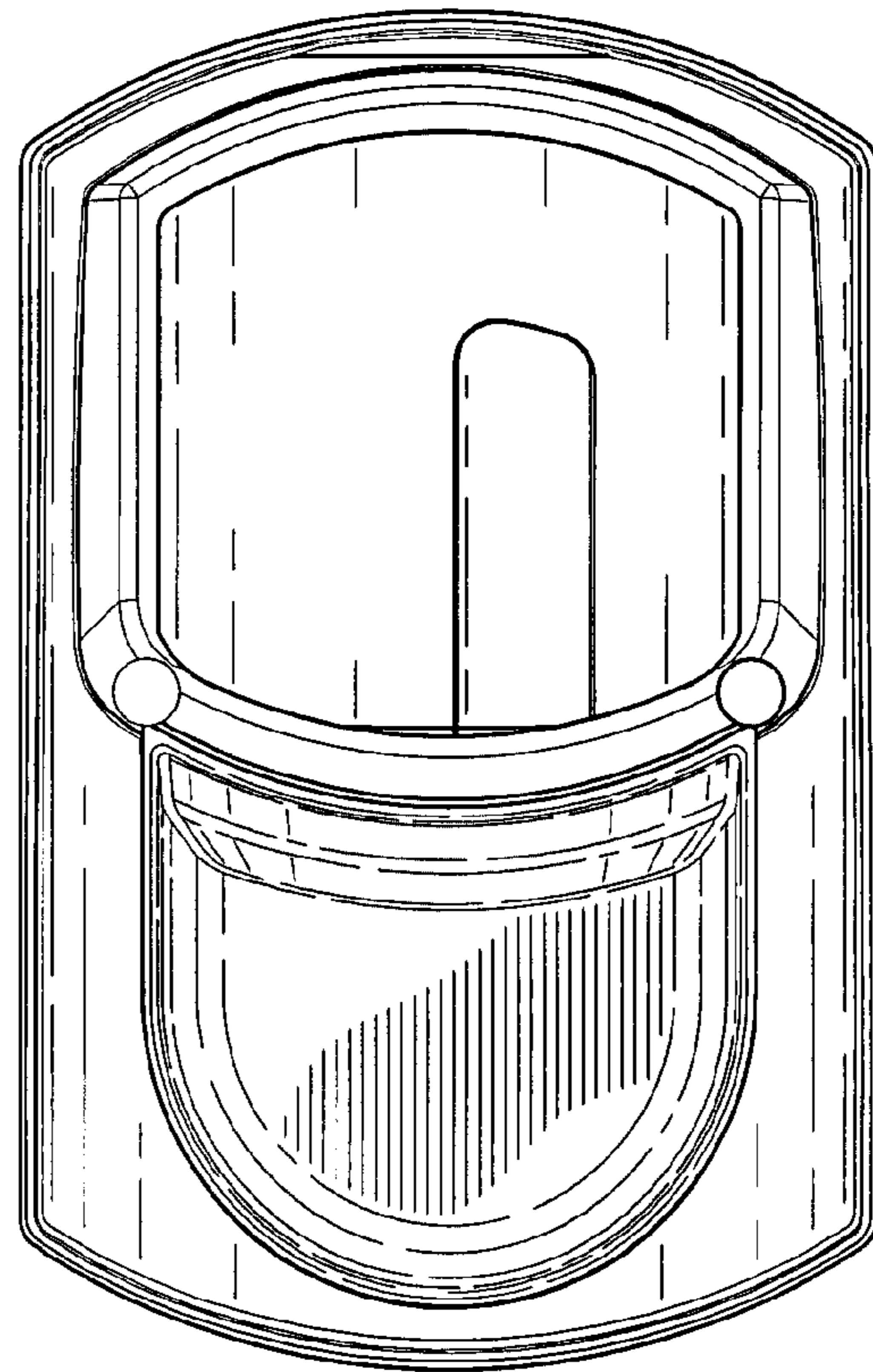

FIG-2

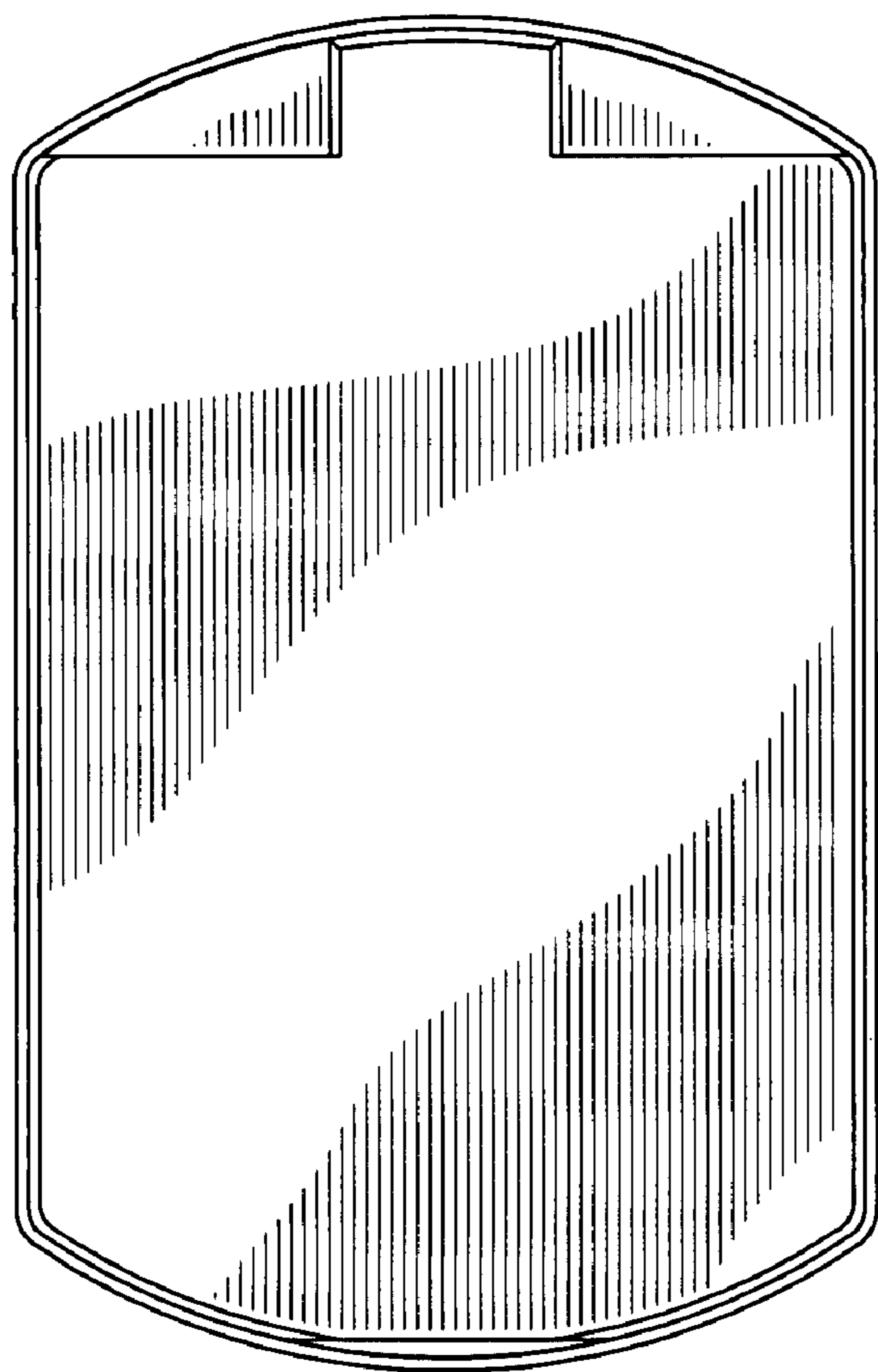

FIG-6

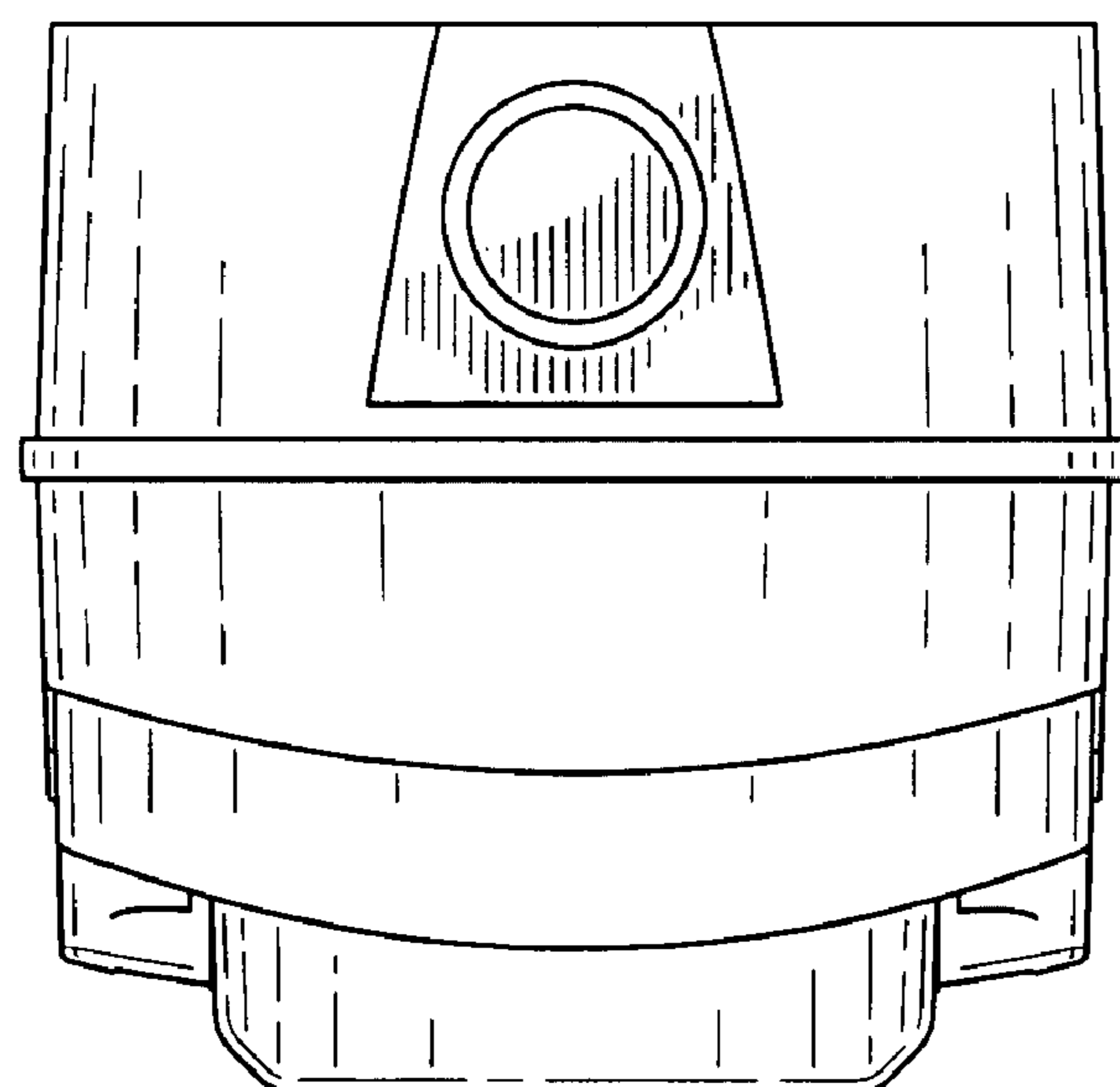

FIG-5