

US00D566595S

(12) **United States Design Patent** (10) **Patent No.:** **US D566,595 S**
Benning et al. (45) **Date of Patent:** **** Apr. 15, 2008**

(54) **TOTAL AIR TEMPERATURE PROBE**

5,628,565 A 5/1997 Hagen et al.

(Continued)

(75) Inventors: **Kevin J. Benning**, Lakeville, MN (US);
Fred A. Steffen, Shakopee, MN (US);
Charles R. Willcox, Eden Prairie, MN
(US); **Paul A. Ice**, Apple Valley, MN
(US)

FOREIGN PATENT DOCUMENTS

FR 2 808 874 5/2000
WO 94/02814 2/1994
WO 01/44821 A1 6/2001

(73) Assignee: **Rosemount Aerospace Inc.**, Burnsville,
MN (US)

OTHER PUBLICATIONS

Stickney, T. M. "Total Temperature Sensors, Technical Report 5755,
Revision C", Rosemount Aerospace/BFGoodrich, pp. 2-28, Jan.
1994.

(**) Term: **14 Years**

Primary Examiner—Antoine D. Davis

(21) Appl. No.: **29/279,816**

(74) *Attorney, Agent, or Firm*—John D. Veldhuis-Kroeze;
Westman, Champlin & Kelly, P.A.

(22) Filed: **May 8, 2007**

(57) **CLAIM**

Related U.S. Application Data

The ornamental design for a total air temperature probe, as
shown and described.

(62) Division of application No. 29/238,755, filed on Sep.
20, 2005, now Pat. No. Des. 545,227.

DESCRIPTION

(51) **LOC (8) Cl.** **10-04**

FIG. 1 is a perspective view as seen from the front, side and
top of a second embodiment of a total air temperature probe
of the present invention;

(52) **U.S. Cl.** **D10/96**

(58) **Field of Classification Search** D10/96;
73/861.65, 861.66, 861.67, 861.68; 374/139,
374/135, 148

FIG. 2 is a top plan view of the total air temperature probe
of FIG. 1;

See application file for complete search history.

FIG. 3 is a bottom plan view of the total air temperature
probe of FIG. 1;

(56) **References Cited**

U.S. PATENT DOCUMENTS

2,970,475 A 2/1961 Werner
3,167,960 A 2/1965 Miesiak
3,368,406 A 2/1968 Himbaugh
3,512,414 A 5/1970 Rees
4,036,054 A 7/1977 Goulet
4,047,379 A 9/1977 Brookes et al.
4,206,645 A 6/1980 Orcutt
4,403,872 A 9/1983 DeLeo
4,458,137 A 7/1984 Kirkpatrick
4,821,566 A 4/1989 Johnston et al.
5,043,558 A * 8/1991 Byles 73/861.68
5,302,026 A 4/1994 Phillips
5,466,067 A 11/1995 Hagen et al.

FIG. 4 is a front elevational view of the total air temperature
probe of FIG. 1;

FIG. 5 is a rear elevational view of the total air temperature
probe of FIG. 1;

FIG. 6 is a left side view of the total air temperature probe
of FIG. 1; and,

FIG. 7 is a right side view of the total air temperature probe
of FIG. 1.

The broken line showing of elements of the total air tem-
perature probe are included for the purpose of illustrating
non-claimed subject matter and forms no part of the claimed
design.

1 Claim, 4 Drawing Sheets

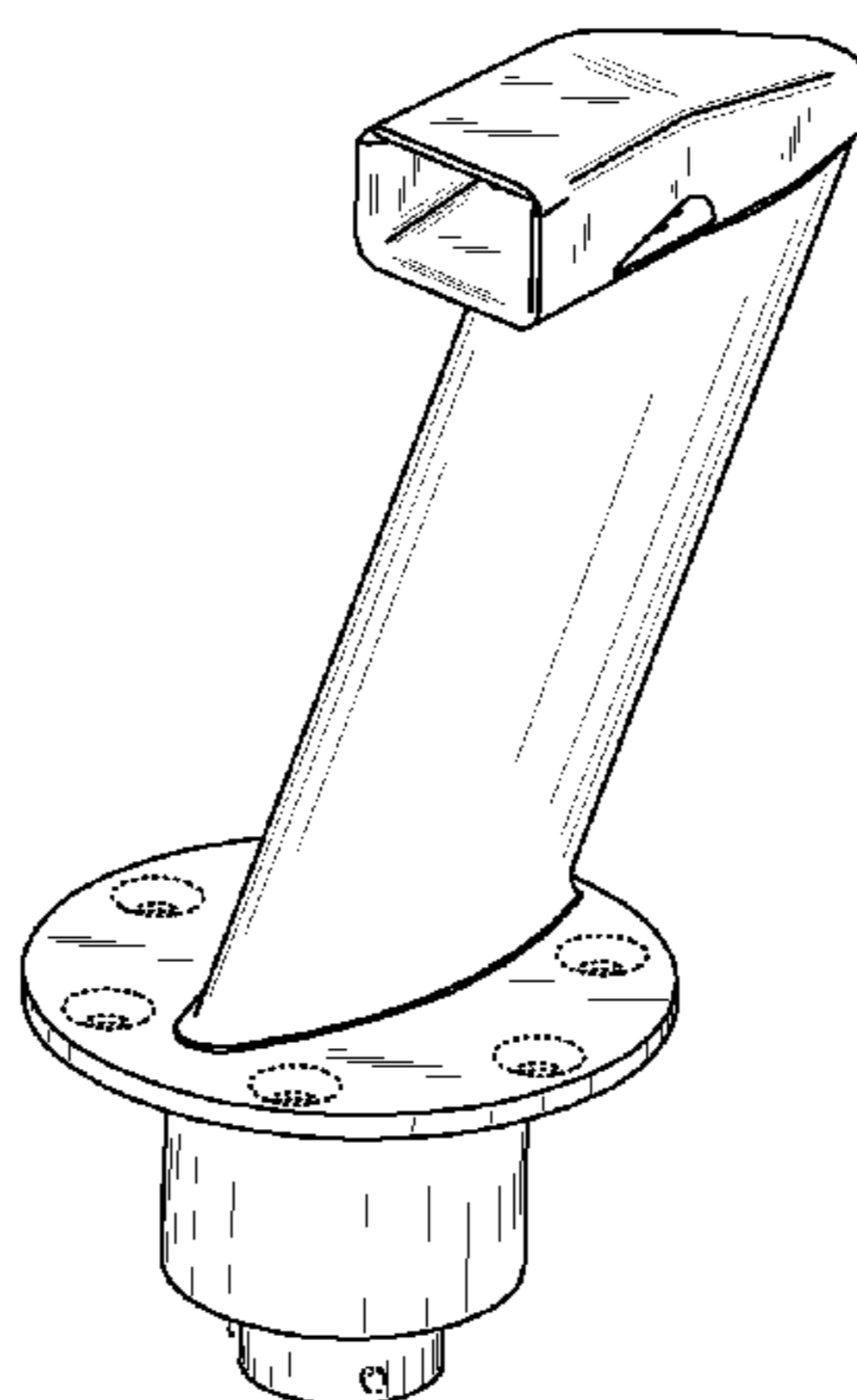

US D566,595 S

Page 2

U.S. PATENT DOCUMENTS

5,731,507	A	3/1998	Hagen et al.	6,651,515	B2	11/2003	Bernard
6,070,475	A	6/2000	Muehlhauser et al.	D497,114	S	10/2004	Willcox
6,076,963	A	6/2000	Menzies et al.	6,840,672	B2	1/2005	Ice et al.
6,609,825	B2	8/2003	Ice et al.	D545,227	S	6/2007	Benning et al.
6,622,556	B1	9/2003	May	2007/0064766	A1	3/2007	Benning

* cited by examiner

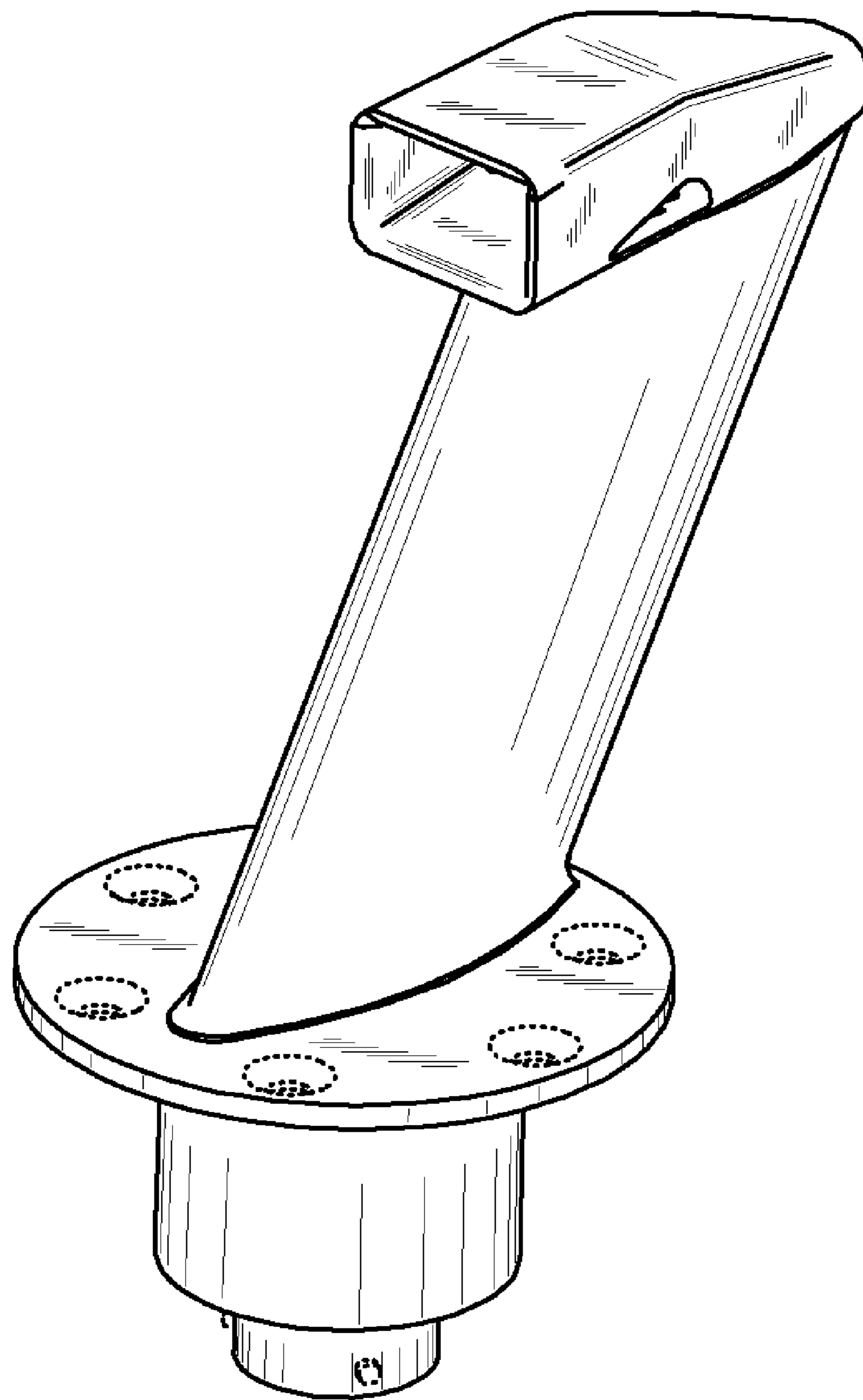

FIG. 1

FIG. 2

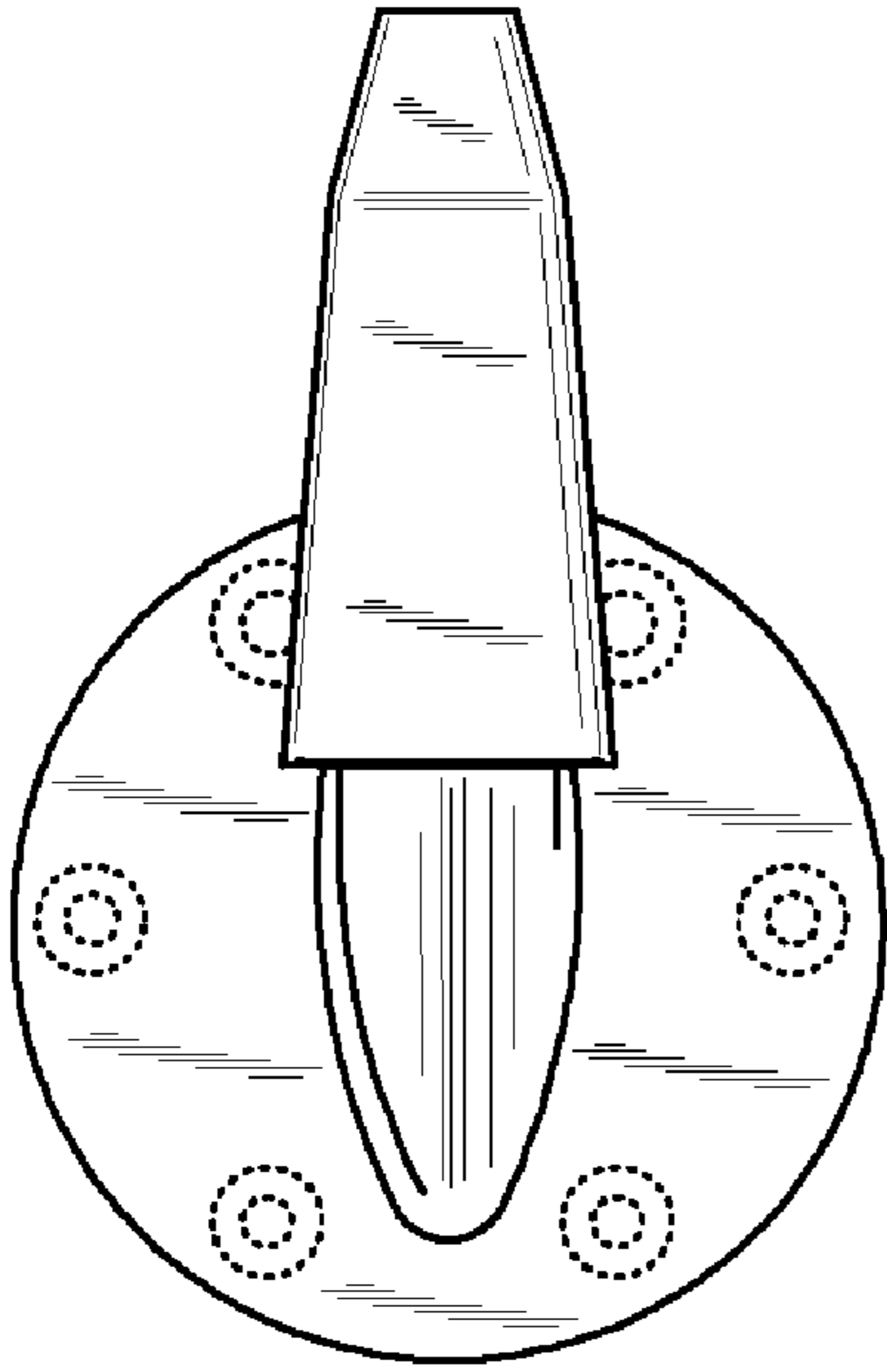
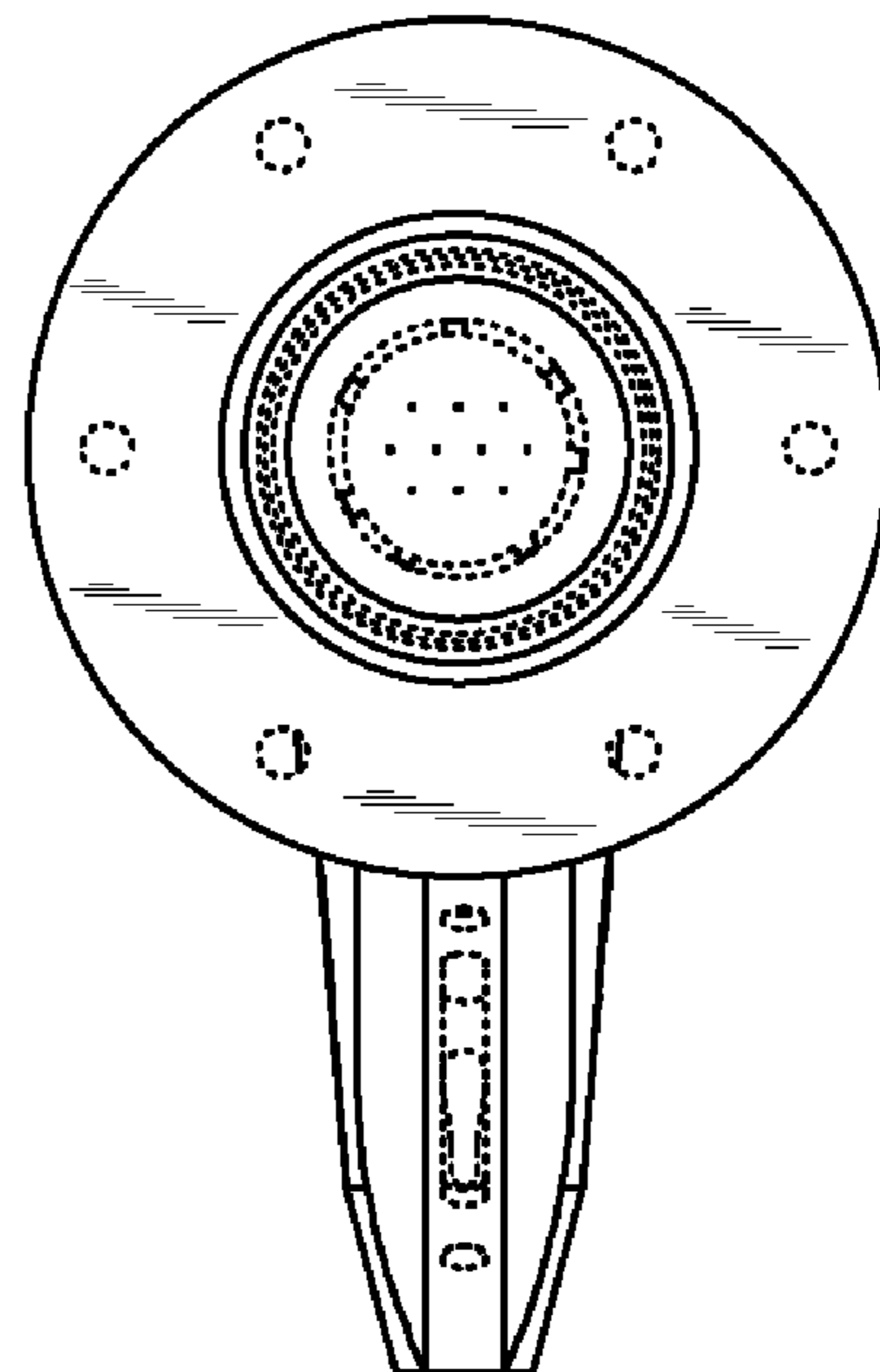

FIG. 3



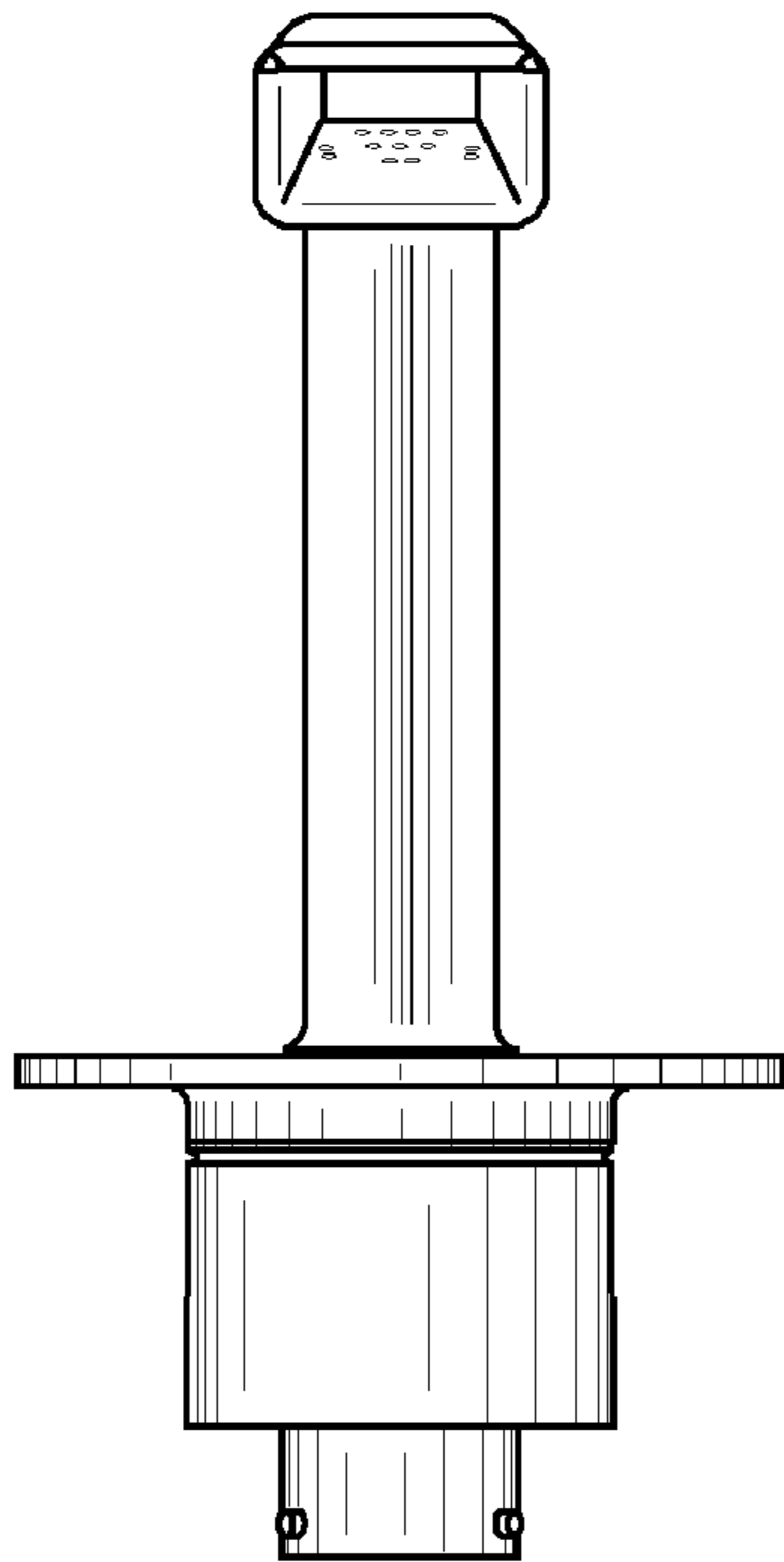
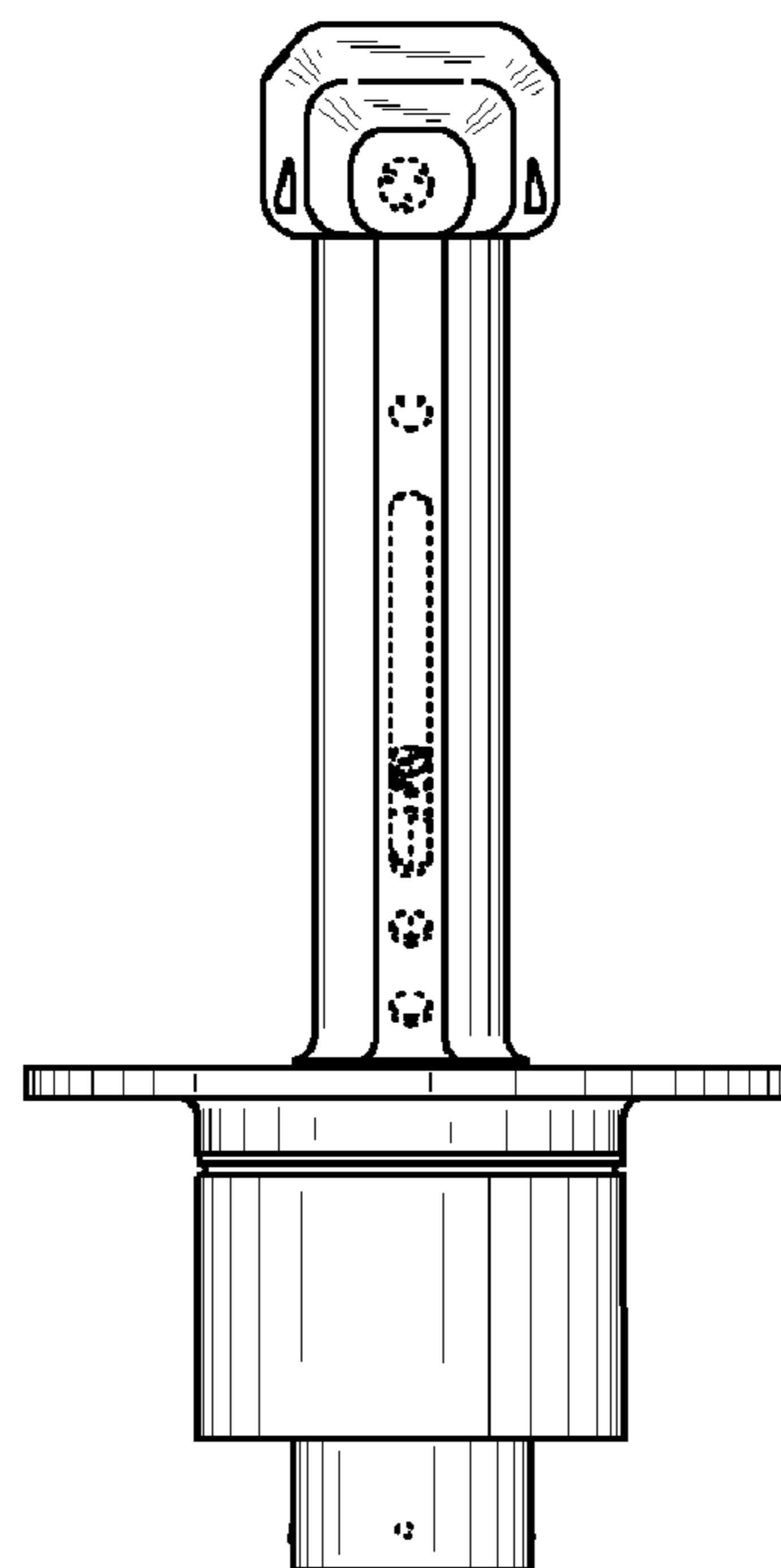

FIG. 4

FIG. 5



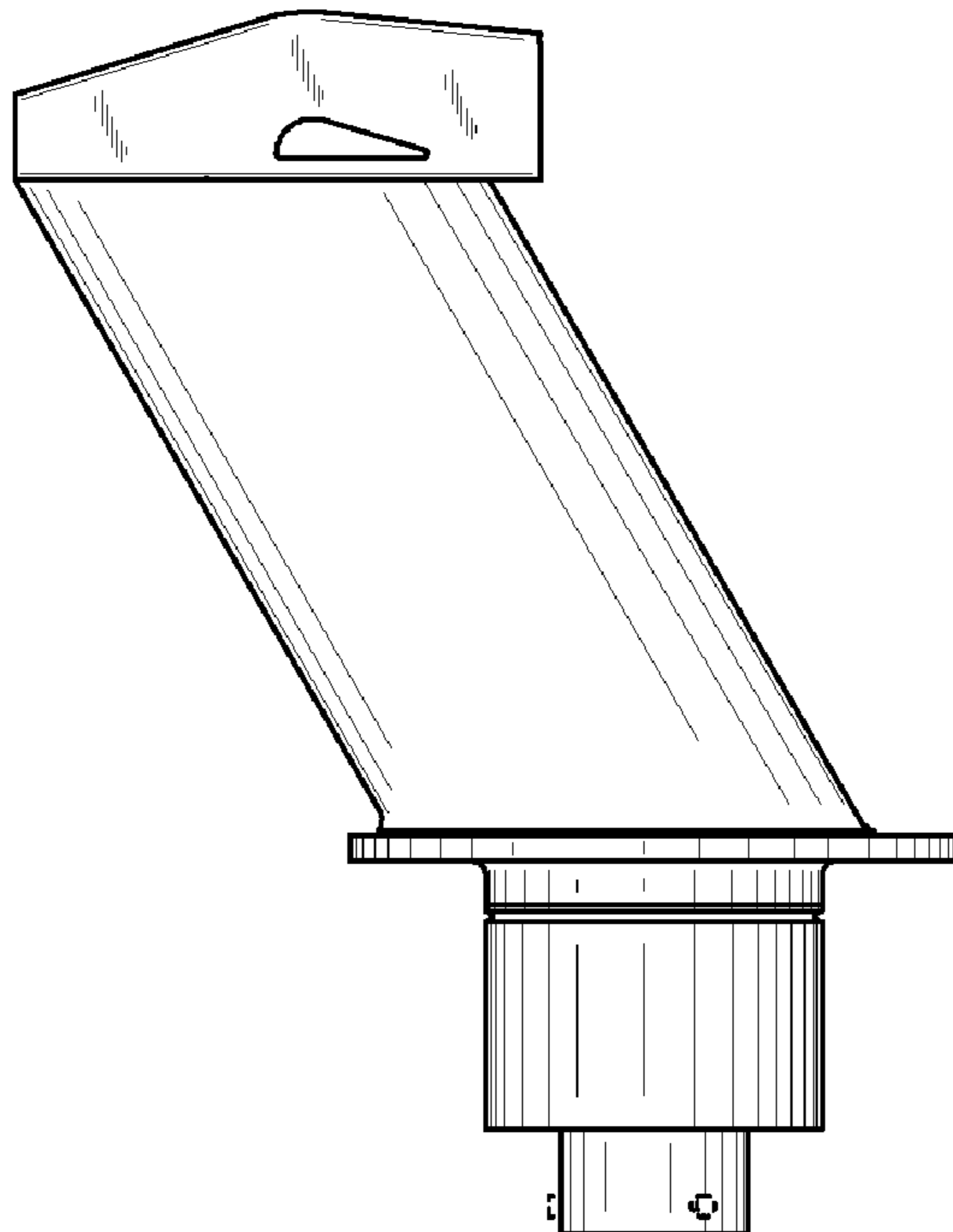

FIG. 6

FIG. 7

