



US00D566532S

(12) **United States Design Patent**
Wolff

(10) **Patent No.:** **US D566,532 S**

(45) **Date of Patent:** **** Apr. 15, 2008**

(54) **HOOK**

D482,600 S * 11/2003 Dretzka D8/367

(76) Inventor: **Stephen H. Wolff**, Wolff Medical Marketing and Design, LLC, 110 E. 42nd St., Suite 1418, New York, NY (US) 10017

* cited by examiner

Primary Examiner—T. Chase Nelson
Assistant Examiner—Barbara B Lohr
(74) *Attorney, Agent, or Firm*—Lerner, David, Littenberg, Krumholz & Mentlik, LLP

(**) Term: **14 Years**

(21) Appl. No.: **29/291,381**

(57) **CLAIM**

(22) Filed: **Aug. 27, 2007**

The ornamental design for a hook, as shown and described.

(51) **LOC (8) Cl.** **08-05**

DESCRIPTION

(52) **U.S. Cl.** **D8/367**

FIG. 1 is a perspective view of hook, with the present invention;

(58) **Field of Classification Search** D8/323,

FIG. 2 is a front elevational view of the hook shown in FIG. 1;

D8/354, 367, 371, 373; D6/323, 524, 552, D6/553; D3/228; 248/205.3, 220.41, 220.43, 248/222.12, 223.4, 304, 340, 301, 215; 211/59.1, 211/65, 66, 70.2, 70.8; 40/642.01

FIG. 3 is a top plan view of the hook shown in FIG. 1;

See application file for complete search history.

FIG. 4 is a bottom plan view of the hook shown in FIG. 1;

(56) **References Cited**

FIG. 5 is a right side elevational view of the hook shown in FIG. 1; and,

U.S. PATENT DOCUMENTS

FIG. 6 is a perspective view of the hook shown in FIG. 1, but shown in a condition of use.

- D289,139 S * 4/1987 Chasen D8/367
- D322,361 S * 12/1991 Goodman et al. D6/323
- D349,447 S * 8/1994 Daniller D8/367
- D374,602 S * 10/1996 Protz, Jr. D8/367
- D377,896 S * 2/1997 Mesna et al. D8/367
- D393,412 S * 4/1998 Bries et al. D8/367
- D415,673 S * 10/1999 Hampshire D8/367
- D455,065 S * 4/2002 Berg D8/371
- D467,791 S * 12/2002 Goodman et al. D8/371
- D469,250 S * 1/2003 Armstrong D3/228

The broken line depiction of a magnet shown in FIG. 2, 3, 4, and 5 views as well as the broken line depiction of environmental structure in the FIG. 6 view are both for illustrative purposes only and form no part of the claimed design. The back of the hook, which has not been depicted, also forms no part of the claimed design.

1 Claim, 3 Drawing Sheets

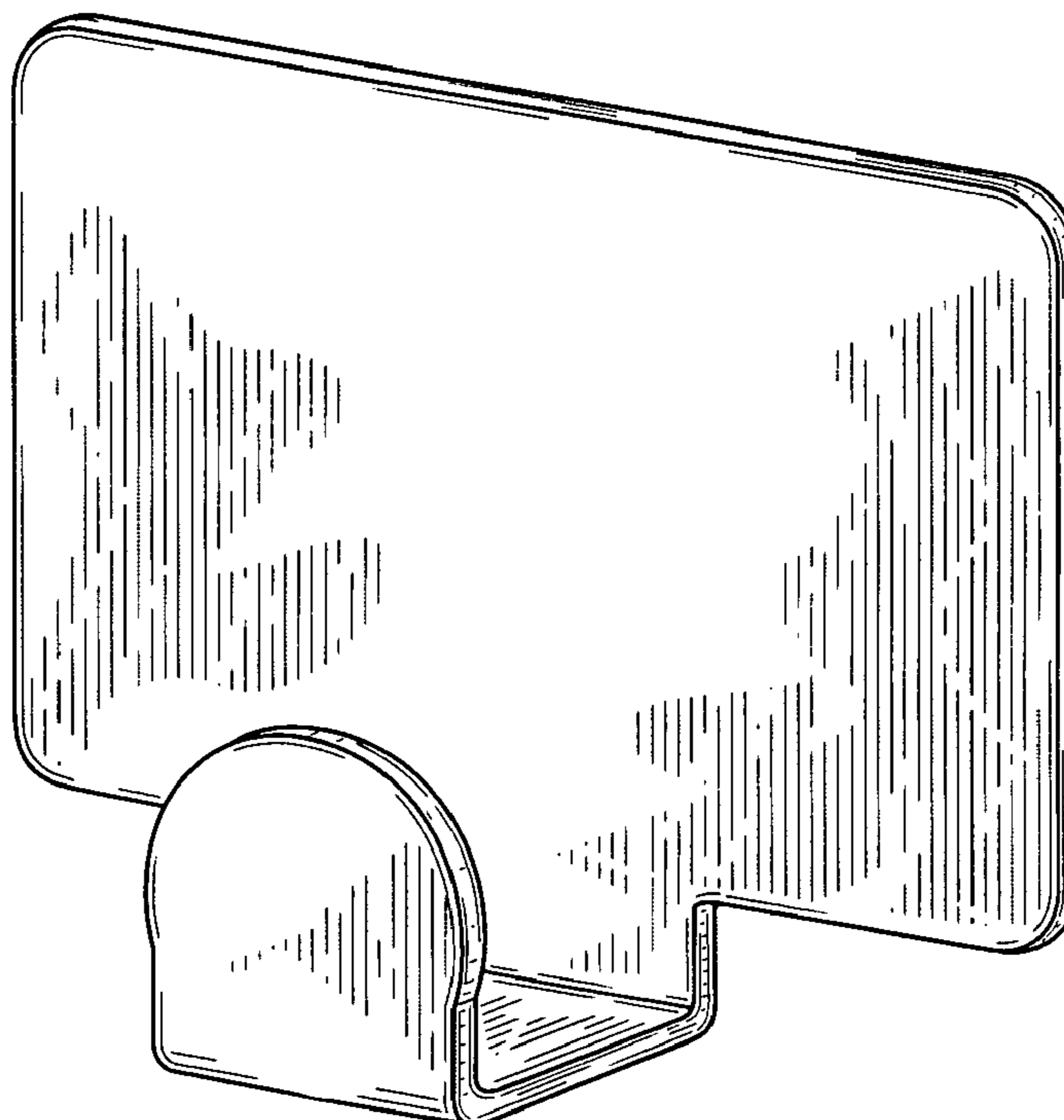

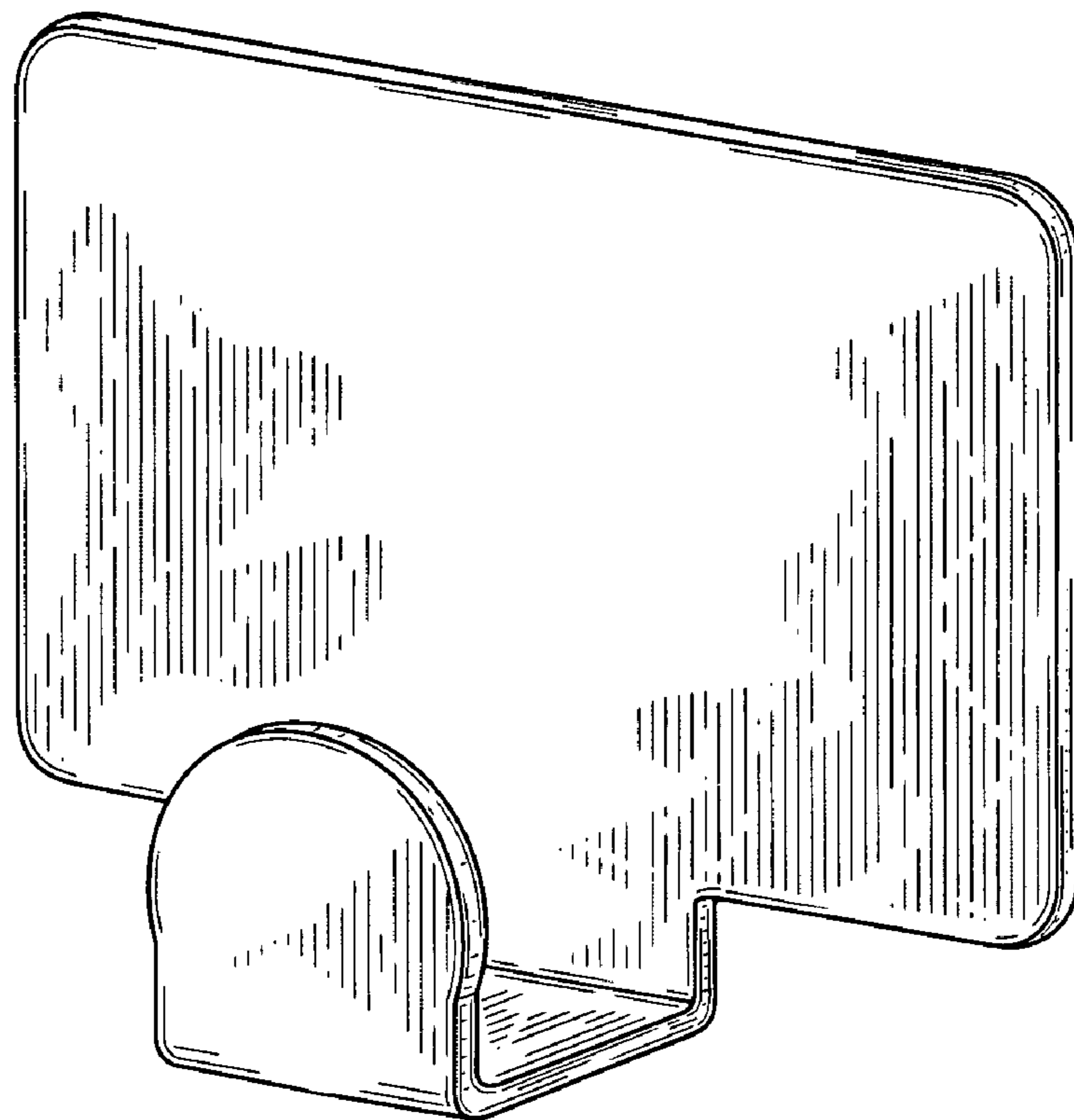

FIG. 1

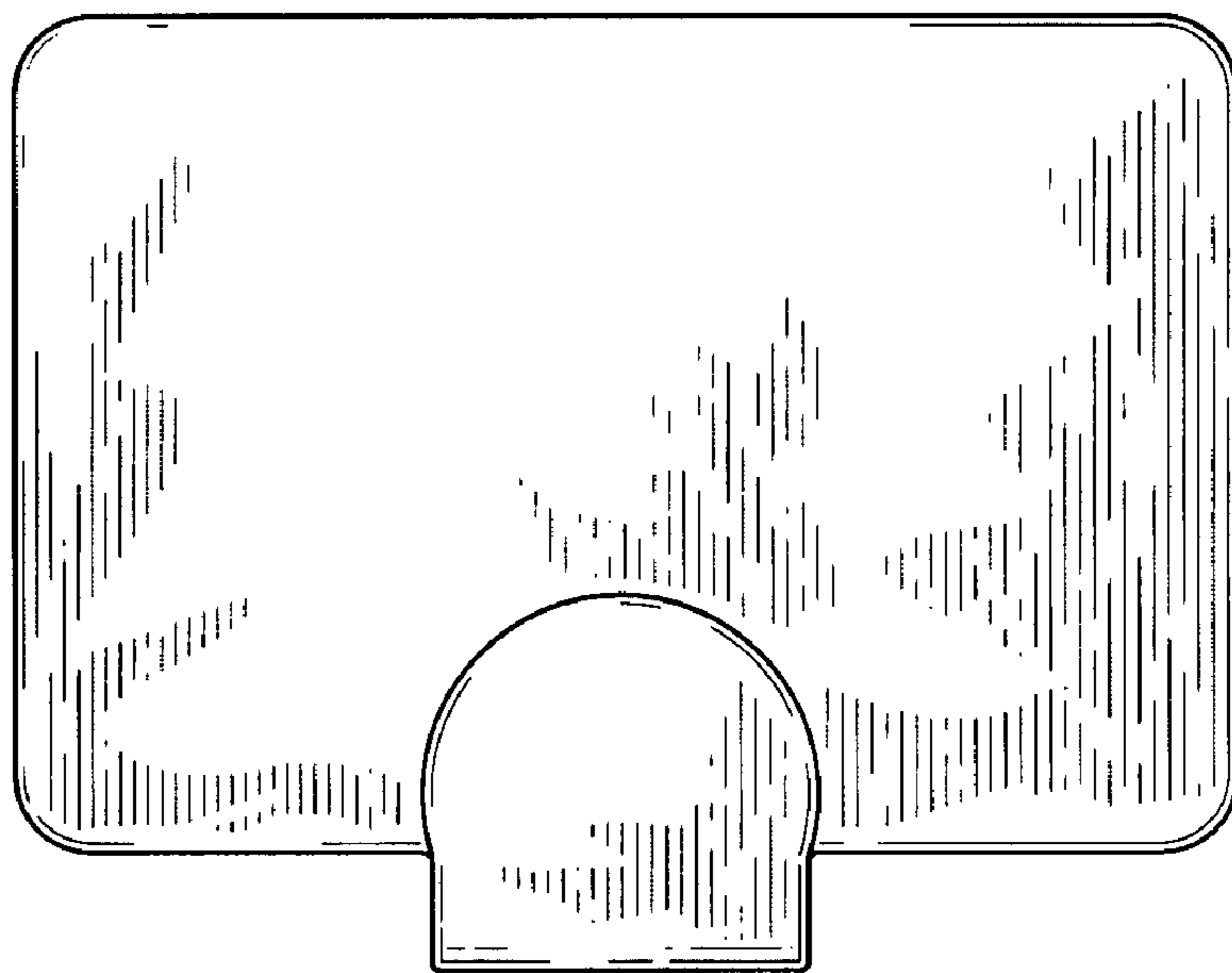

FIG. 2

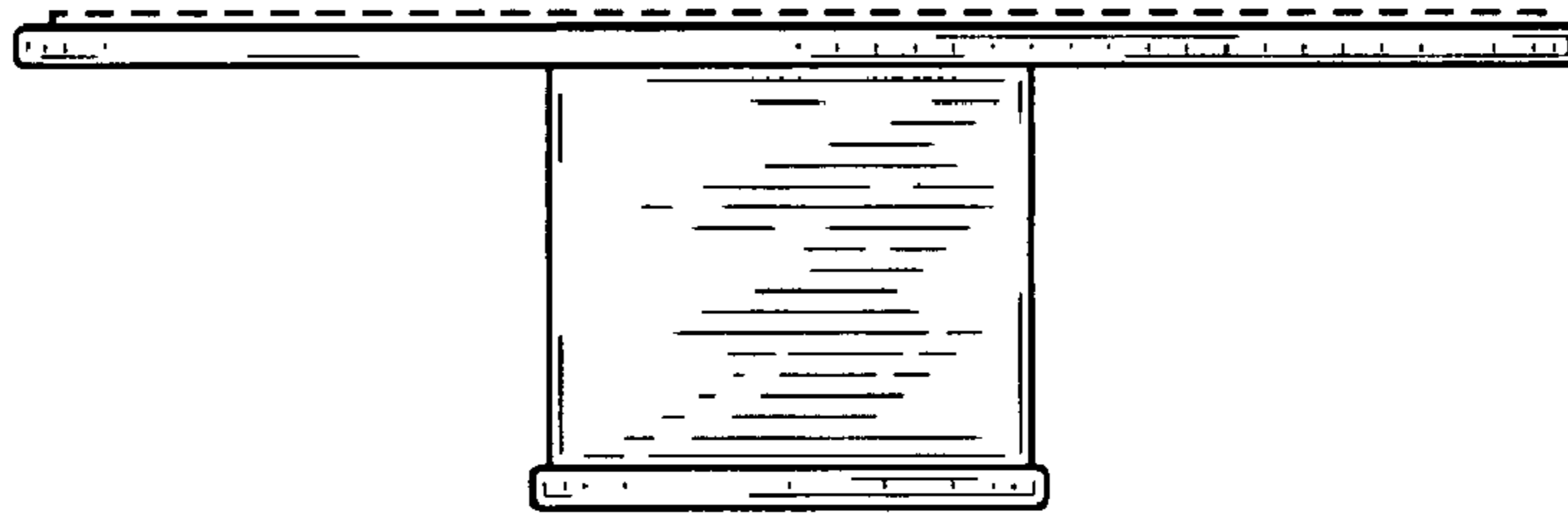

FIG. 3

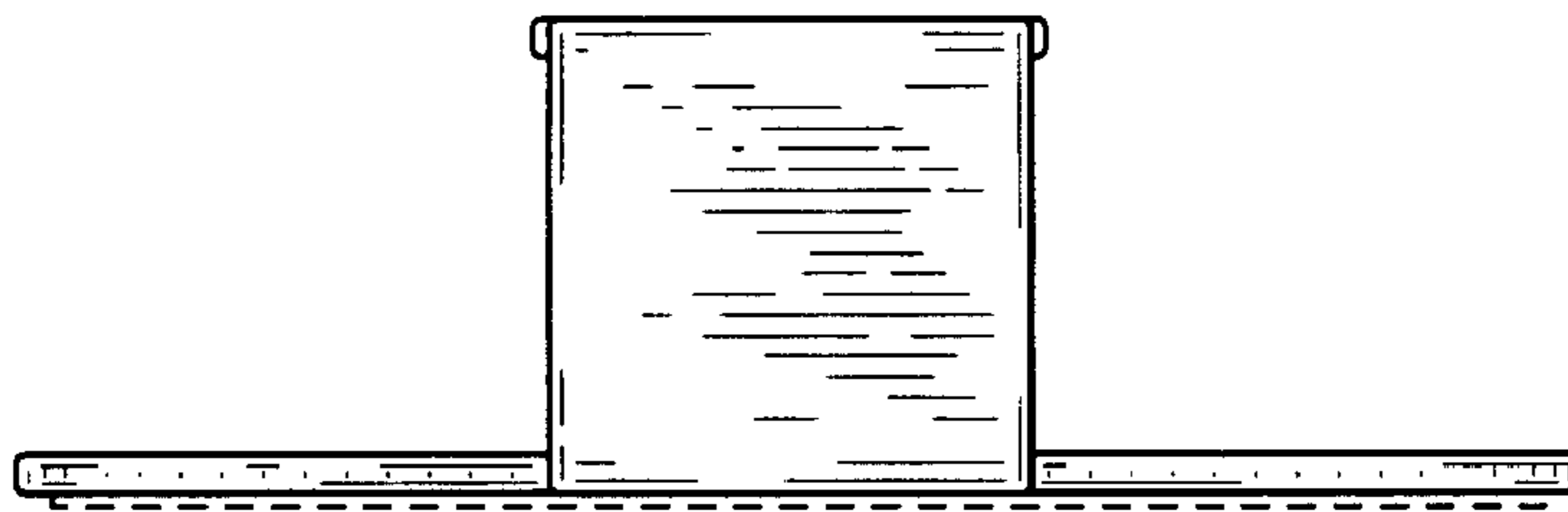

FIG. 4

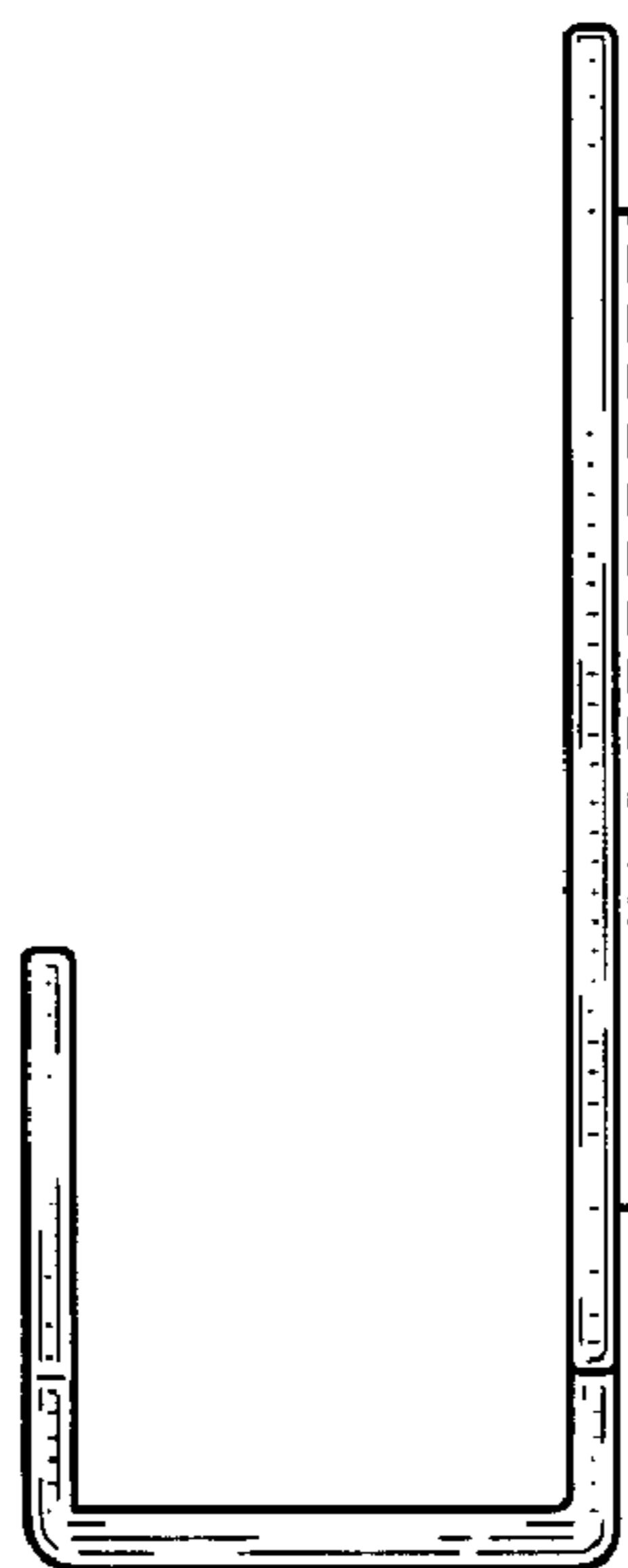

FIG. 5

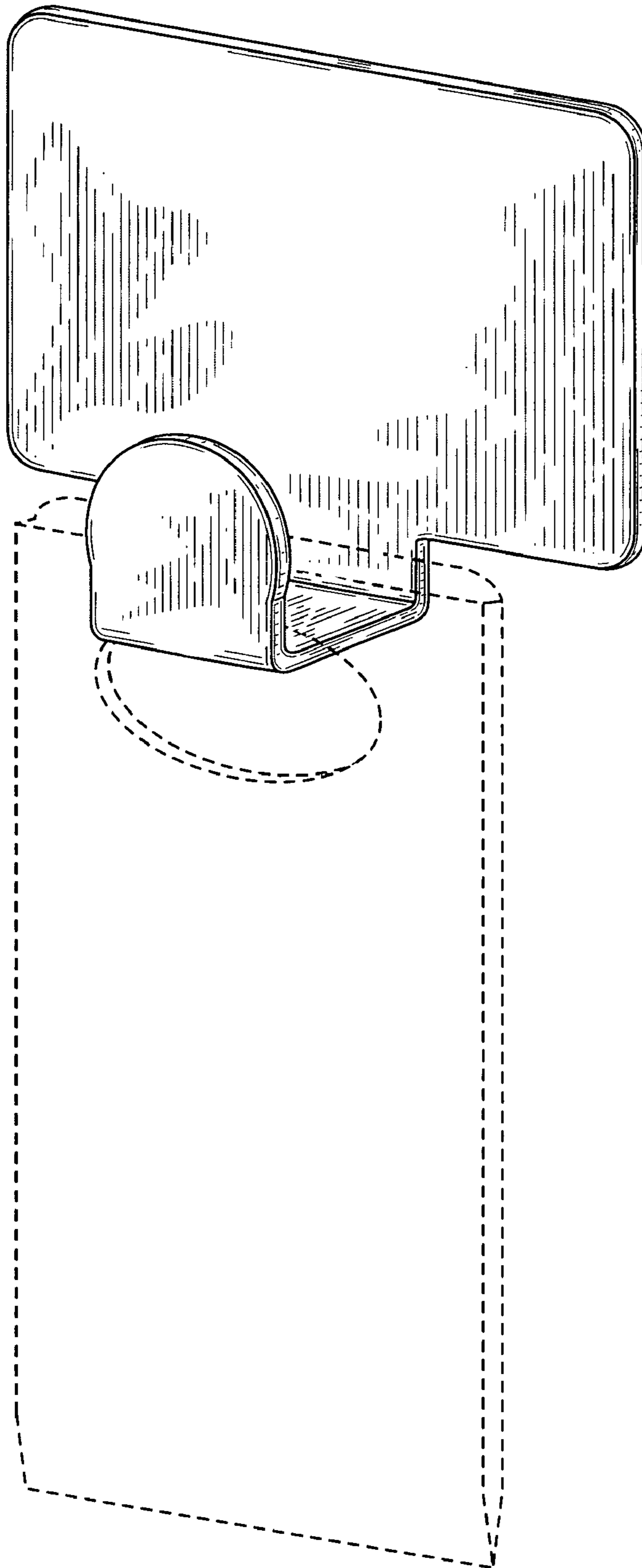

FIG. 6

UNITED STATES PATENT AND TRADEMARK OFFICE
CERTIFICATE OF CORRECTION

PATENT NO. : Des. 566,532 S
APPLICATION NO. : 29/291381
DATED : April 15, 2008
INVENTOR(S) : Stephen H. Wolff

Page 1 of 1

It is certified that error appears in the above-identified patent and that said Letters Patent is hereby corrected as shown below:

On the first page under DESCRIPTION, in Fig. 1, please insert -- the -- before -- perspective view of --.

On the first page under DESCRIPTION, in Fig. 1, please delete “, with the present invention”.

On the first page under DESCRIPTION, in Fig. 6, please delete “but” before -- shown --.

Signed and Sealed this

Eighteenth Day of August, 2009



David J. Kappos
Director of the United States Patent and Trademark Office