

US00D566510S

(12) **United States Design Patent**
Nielsen

(10) **Patent No.:** **US D566,510 S**

(45) **Date of Patent:** **** Apr. 15, 2008**

(54) **AXE HEAD WITH NOTCHES FOR RECEIVING THE FORKED END OF A HOOLIGAN TOOL**

D378,656 S * 4/1997 Maine D8/78
D510,691 S * 10/2005 Storm D8/76
D549,065 S * 8/2007 Chen D8/78

(75) Inventor: **Peter K. Nielsen**, Frankford, IL (US)

* cited by examiner

(73) Assignee: **Paratech Incorporated**, Frankford, IL (US)

Primary Examiner—Philip S. Hyder

(74) *Attorney, Agent, or Firm*—Jon Carl Gealow

(**) Term: **14 Years**

(57) **CLAIM**

(21) Appl. No.: **29/267,936**

The ornamental design for a axe head with notches for receiving the forked end of a hooligan tool, as shown and described.

(22) Filed: **Oct. 25, 2006**

DESCRIPTION

(51) **LOC (8) Cl.** **08-02**

(52) **U.S. Cl.** **D8/78; D8/76**

(58) **Field of Classification Search** D8/75,
D8/76, 77, 78, 79, 80, 81; 30/308.1, 308.2;
254/26 R, 26 E; 7/144, 145, 146

See application file for complete search history.

FIG. 1 is a perspective view of an axe head with notches for receiving the forked end of a hooligan tool showing my new design;

FIG. 2 is a right side elevation view thereof;

FIG. 3 is a left side elevation view thereof;

FIG. 4 is a front elevation view thereof;

FIG. 5 is a bottom elevation view thereof;

FIG. 6 is a top elevation view thereof; and,

FIG. 7 is a rear elevation view thereof.

The broken line showing of the axe handle in FIG. 1, and a portion of the axe handle in FIGS. 2 and 3 is included for the purpose of illustrating environmental structure and forms no part of the claimed design.

(56) **References Cited**

U.S. PATENT DOCUMENTS

D115,256 S * 6/1939 Vaughan D8/76
D243,314 S * 2/1977 Hedvall D8/76
D257,826 S * 1/1981 Jones D8/78
D266,141 S * 9/1982 Nannen D8/76
4,412,572 A * 11/1983 Clark 30/308.1
4,445,555 A * 5/1984 Klempirik 144/195.7
4,932,127 A * 6/1990 Burke 30/308.1
D340,177 S * 10/1993 Key D8/75
5,482,097 A * 1/1996 Maine 144/195.5

1 Claim, 3 Drawing Sheets

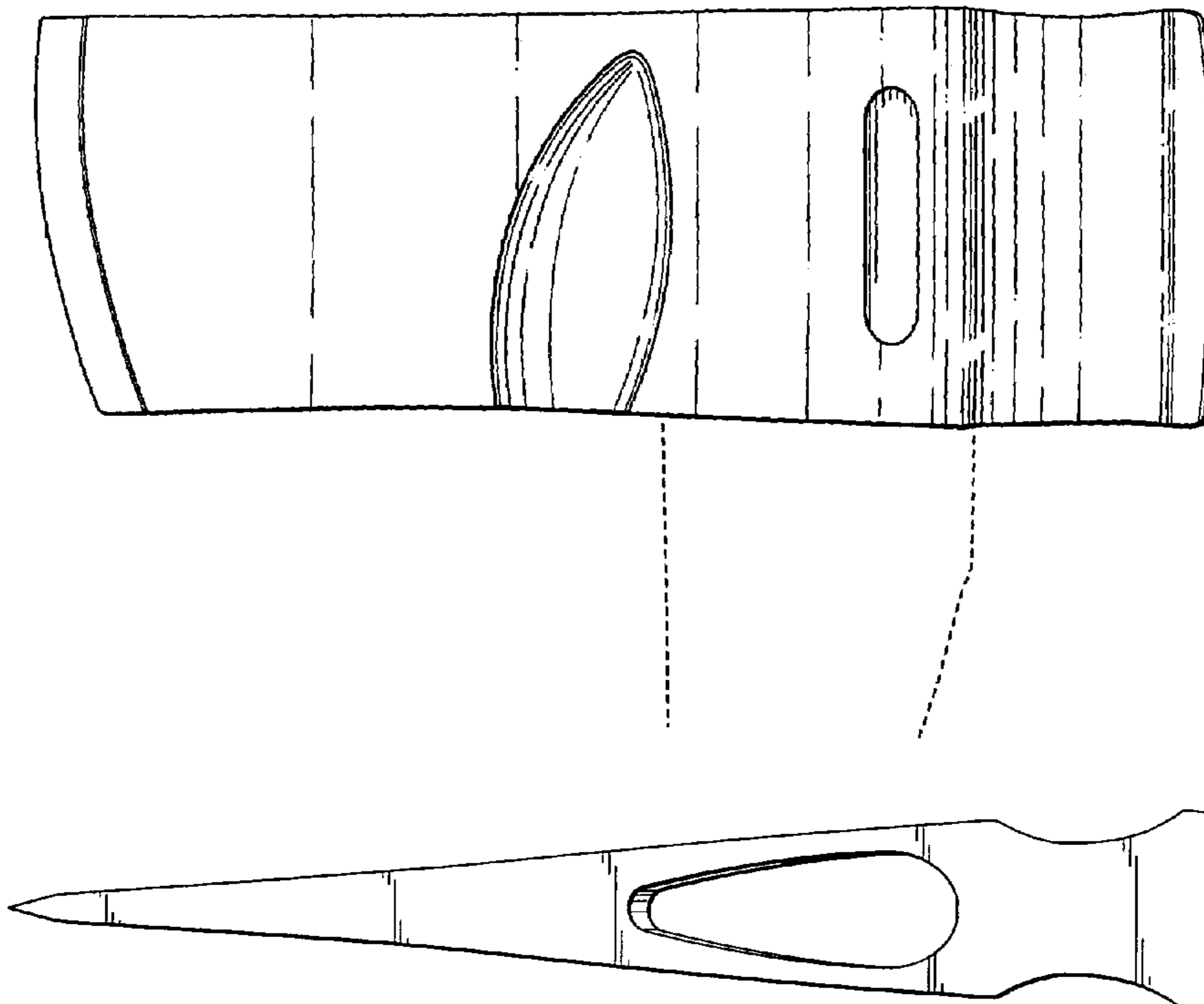

Fig. 1

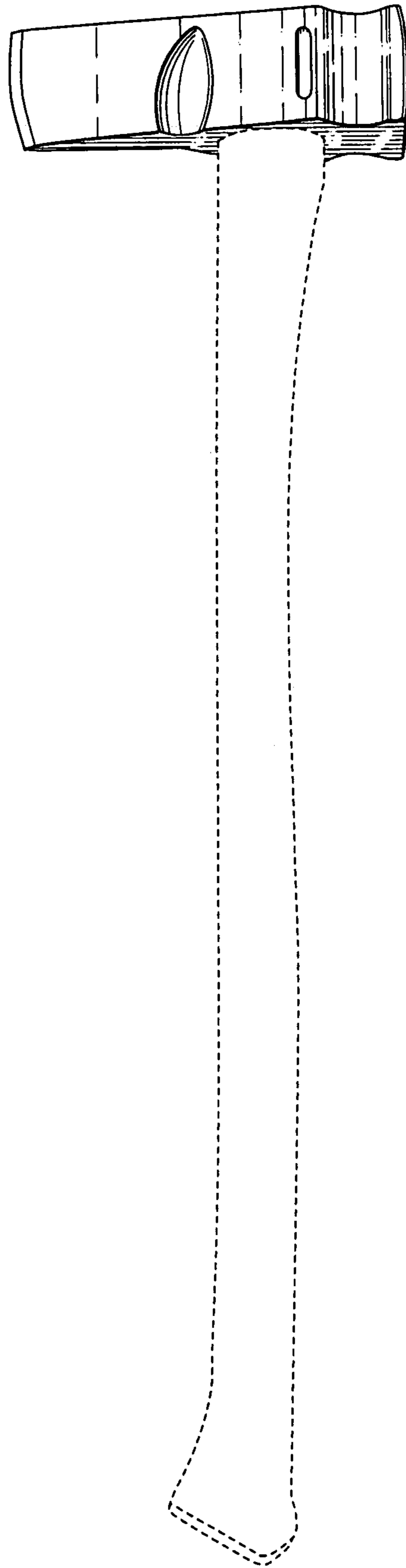

Fig. 2

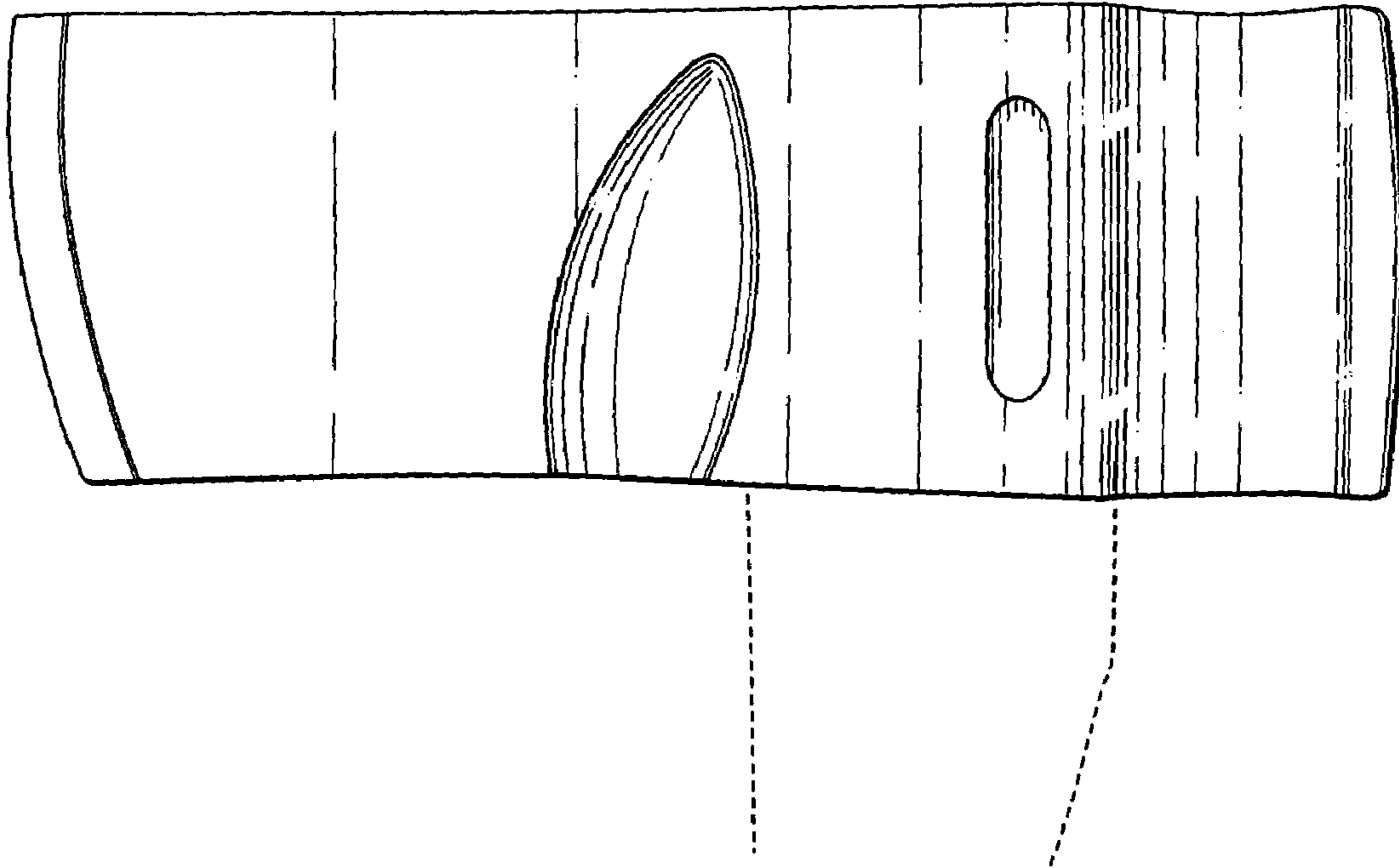

Fig. 3

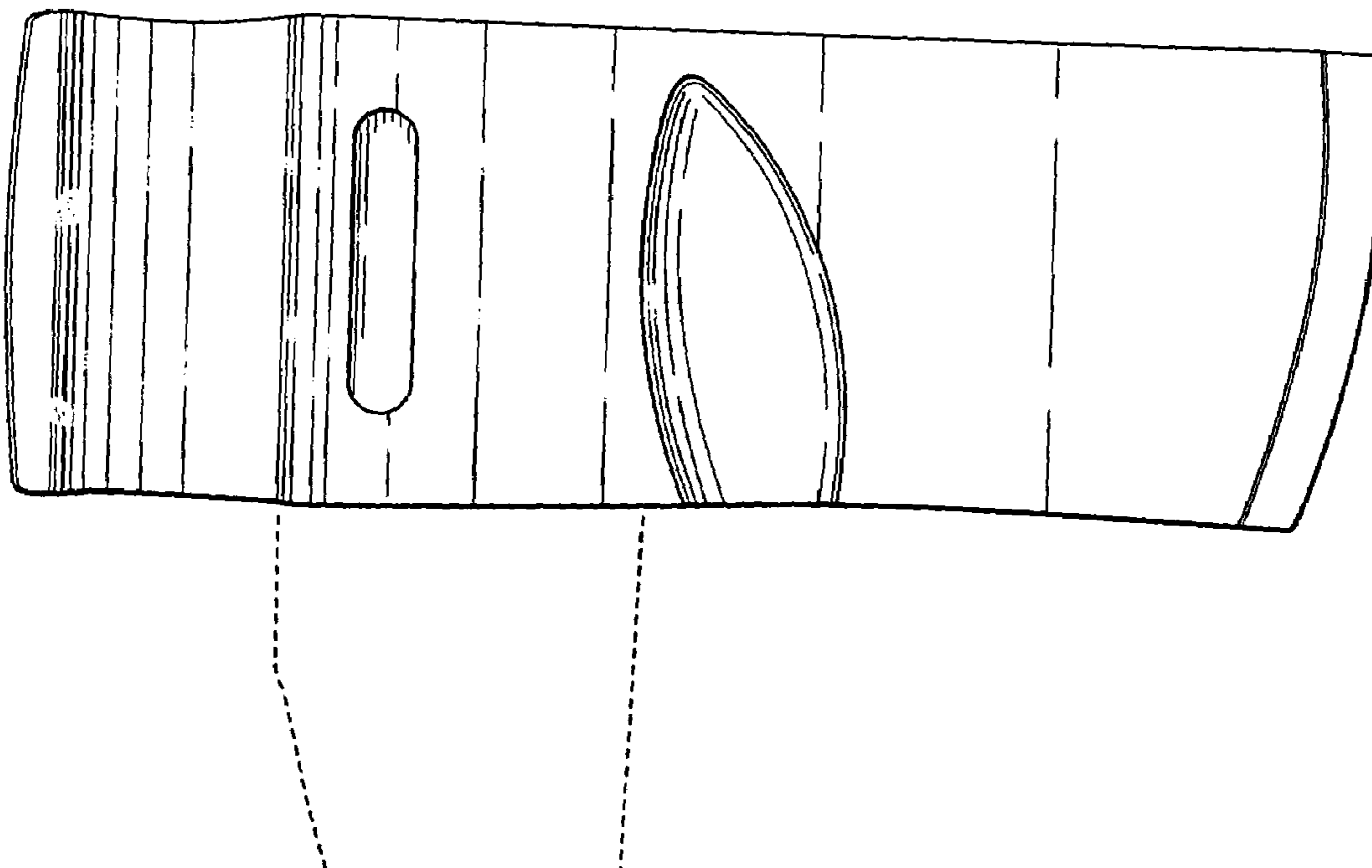

Fig. 4

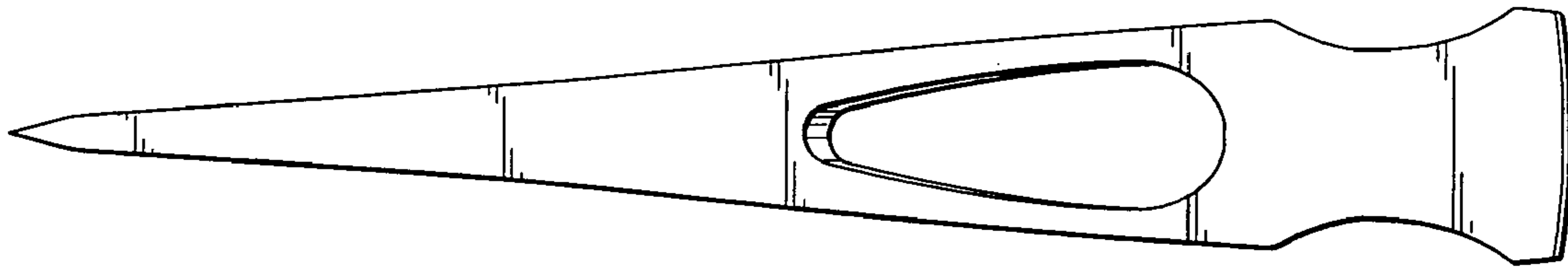

Fig. 5

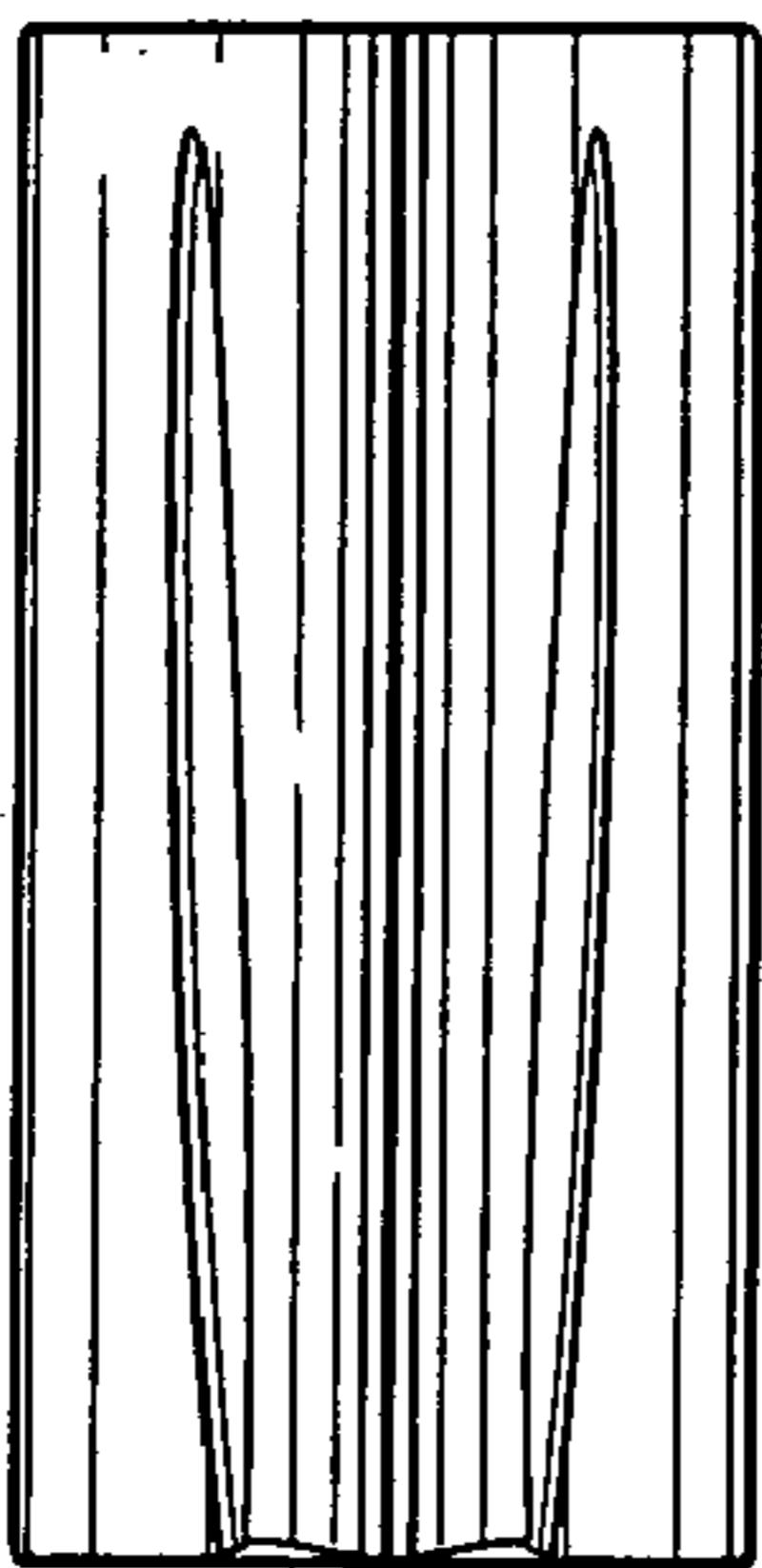

Fig. 6

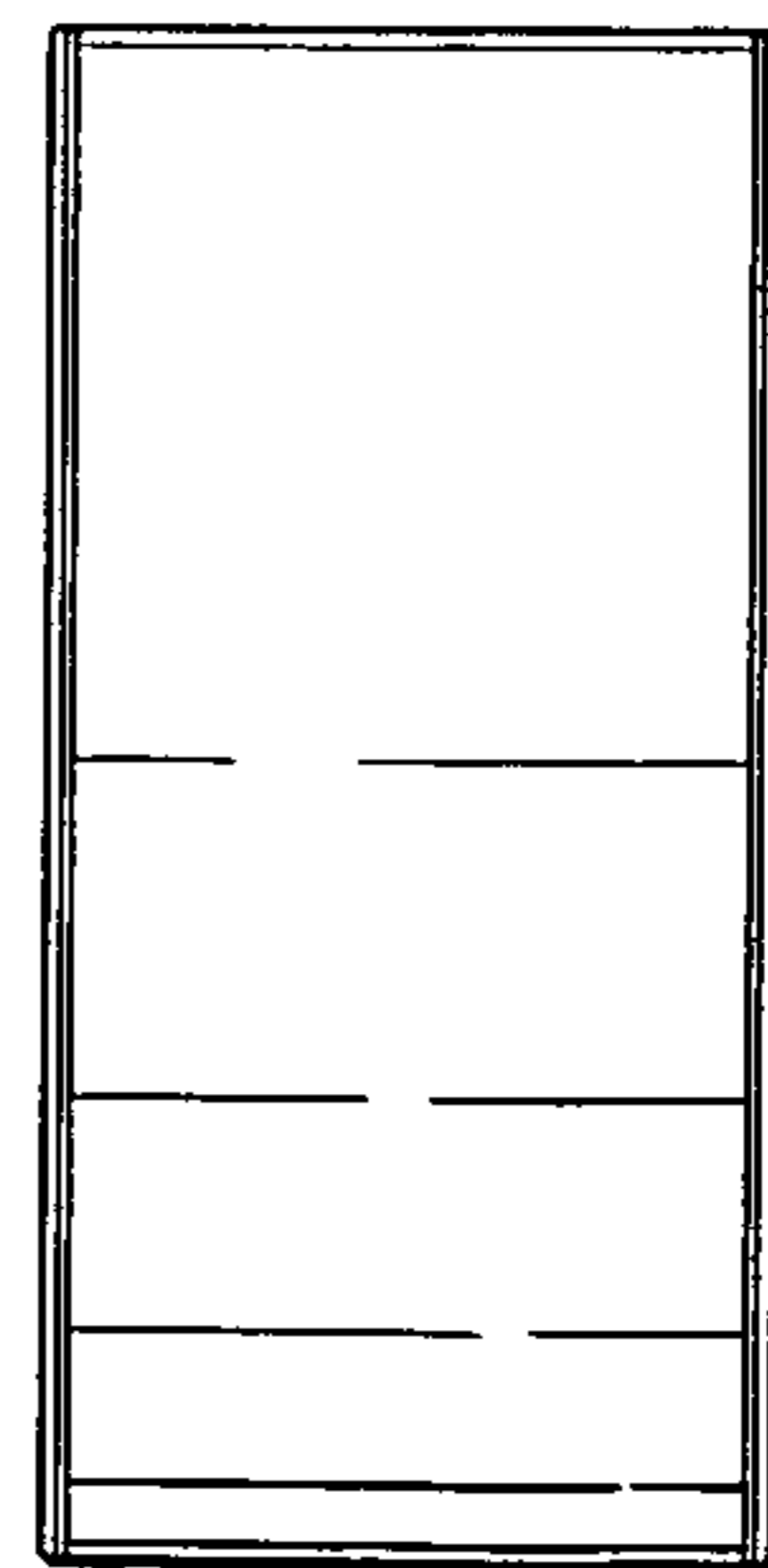

Fig. 7

