



US00D566488S

(12) **United States Design Patent**  
**Griffith et al.**

(10) **Patent No.:** **US D566,488 S**

(45) **Date of Patent:** **\*\* Apr. 15, 2008**

(54) **CONDIMENT GRINDER**

6,871,808 B2 \* 3/2005 Holcomb et al. .... 241/169.1  
6,877,684 B2 \* 4/2005 Wu ..... 241/169.1  
7,007,875 B2 \* 3/2006 Cheng ..... 241/169.1

(75) Inventors: **Jonah S. Griffith**, Seattle, WA (US);  
**David A. Holcomb**, Seattle, WA (US)

\* cited by examiner

(73) Assignee: **Chef'n Corporation**, Seattle, WA (US)

*Primary Examiner*—Terry A Wallace

(\*\*) Term: **14 Years**

(74) *Attorney, Agent, or Firm*—Seed IP Law Group PLLC

(21) Appl. No.: **29/282,357**

(57) **CLAIM**

(22) Filed: **Jul. 17, 2007**

The ornamental design for a condiment grinder, as shown and described.

(51) **LOC (8) Cl.** ..... **07-06**

(52) **U.S. Cl.** ..... **D7/679**

(58) **Field of Classification Search** ..... D7/679,  
D7/372, 373, 590–598, 401.1; 222/142.1–142.9,  
222/452, 480–482; 241/93, 168, 169.1, 285.3  
See application file for complete search history.

**DESCRIPTION**

(56) **References Cited**

U.S. PATENT DOCUMENTS

4,697,749 A \* 10/1987 Holcomb et al. .... 241/169  
D392,517 S \* 3/1998 Holcomb et al. .... D7/679  
5,988,543 A \* 11/1999 Wu ..... 241/168  
D464,852 S \* 10/2002 Tang ..... D7/679  
6,568,616 B1 \* 5/2003 Tang ..... 241/168  
D484,371 S \* 12/2003 Tang et al. .... D7/679

FIG. 1 is a perspective view of a condiment grinder showing our new design.

FIG. 2 is a front elevation view thereof.

FIG. 3 is a rear elevation view thereof.

FIG. 4 is a right side elevation view thereof.

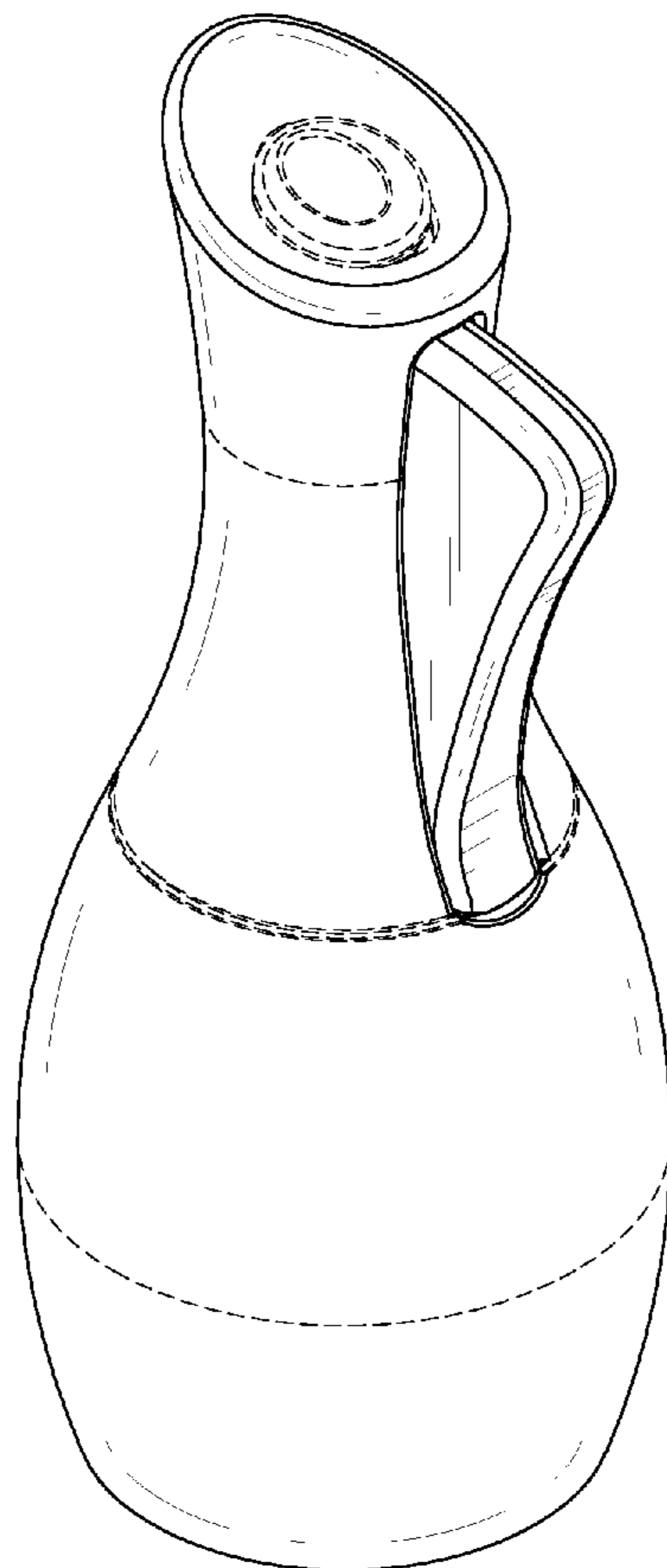
FIG. 5 is a left side elevational view thereof.

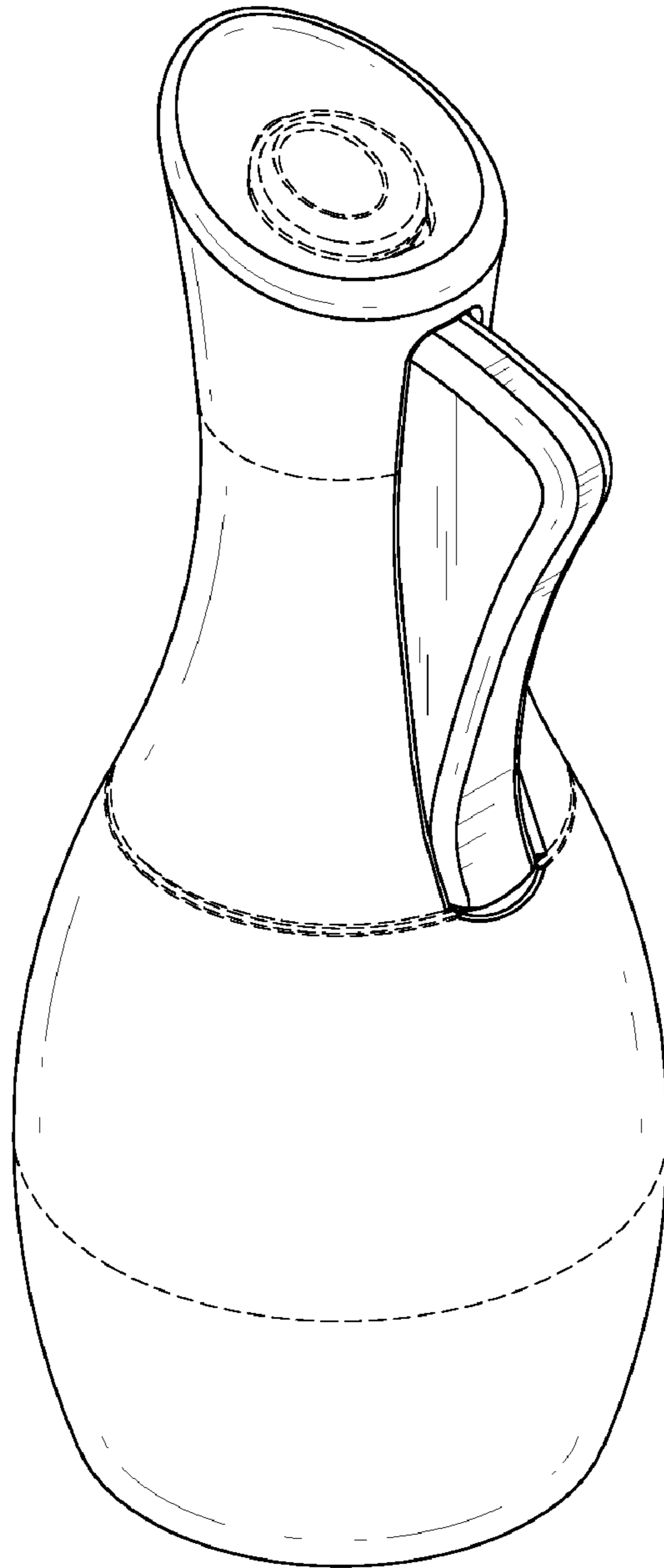
FIG. 6 is a top plan view thereof; and,

FIG. 7 is a bottom plan view thereof.

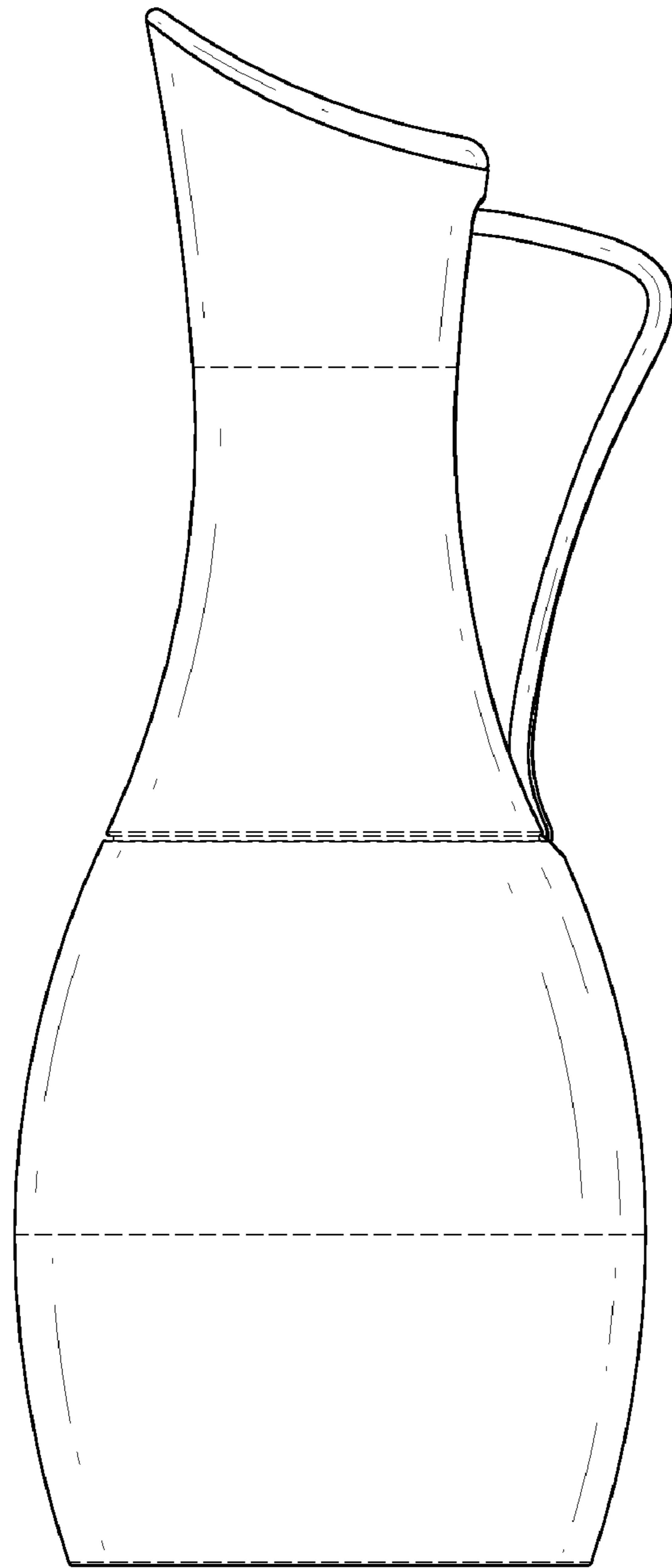
The broken lines in the figures are for illustrative purposes only and form no part of the claimed design.

**1 Claim, 6 Drawing Sheets**

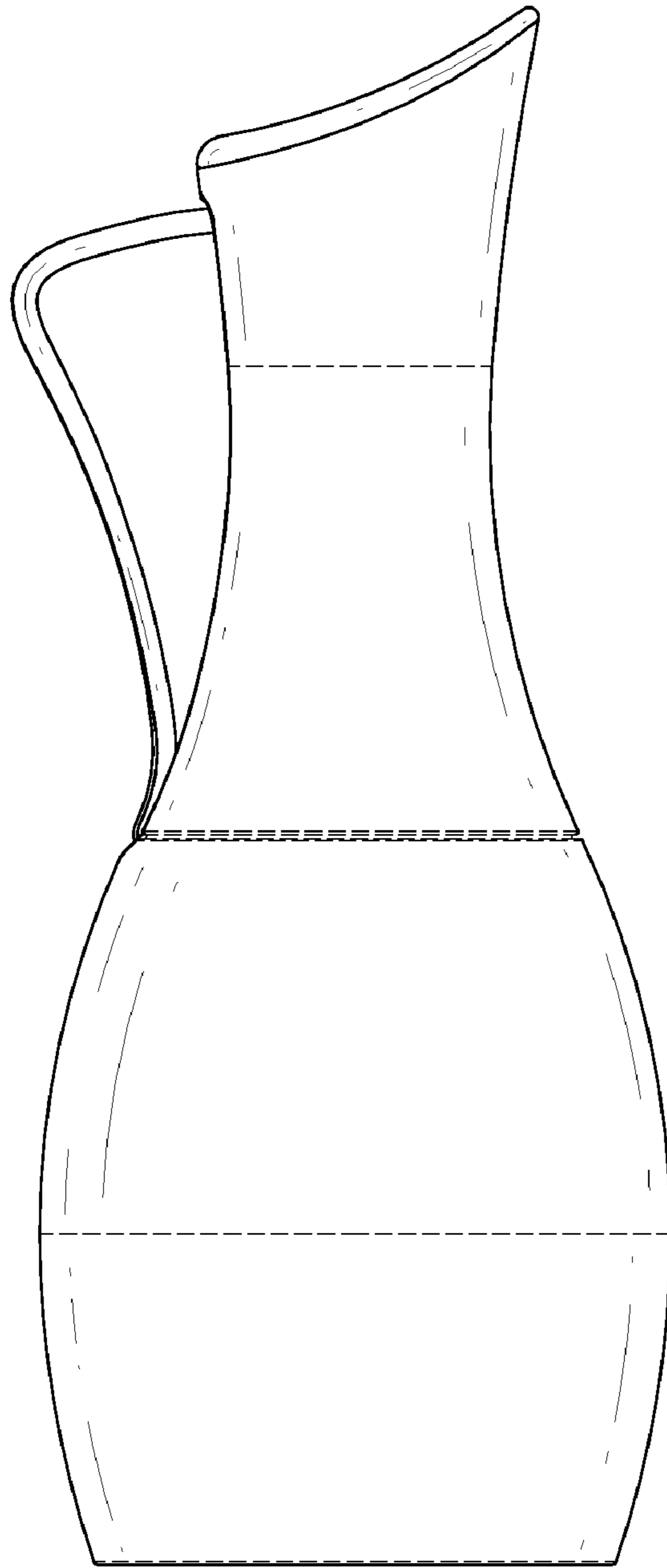




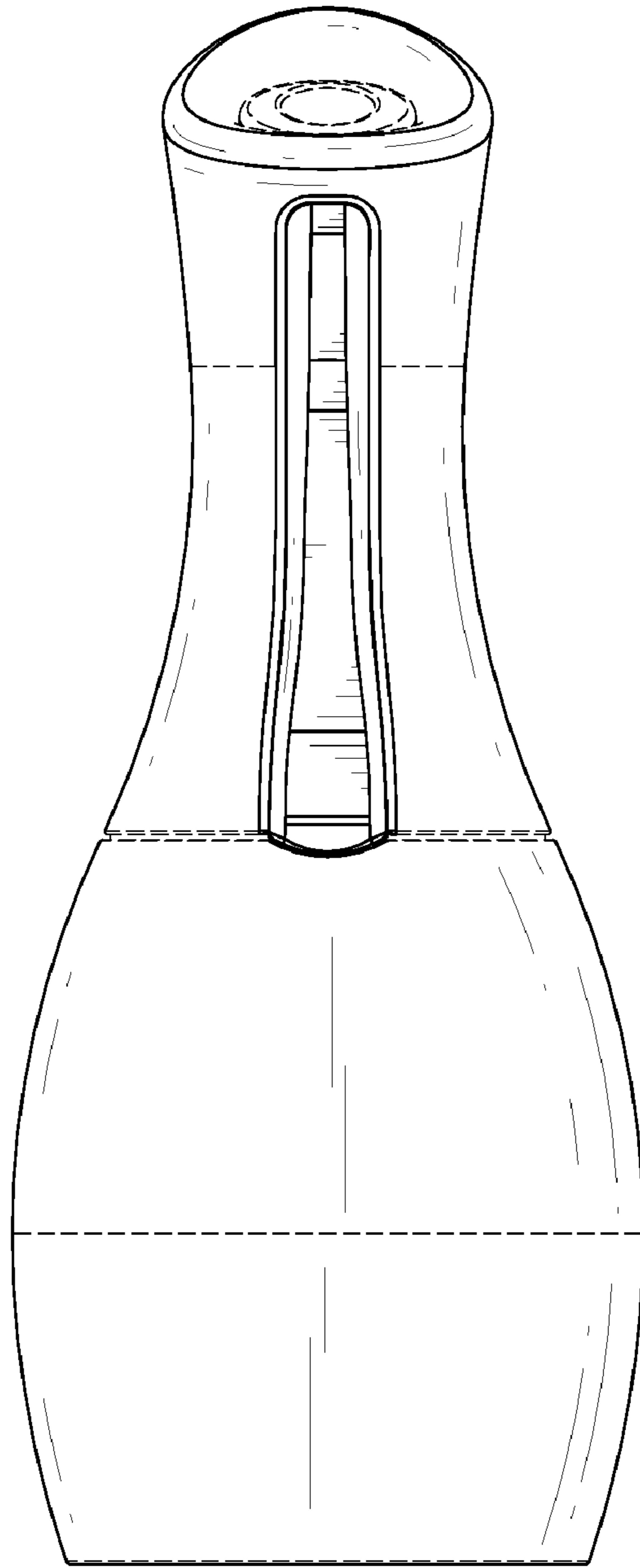
*FIG. 1*



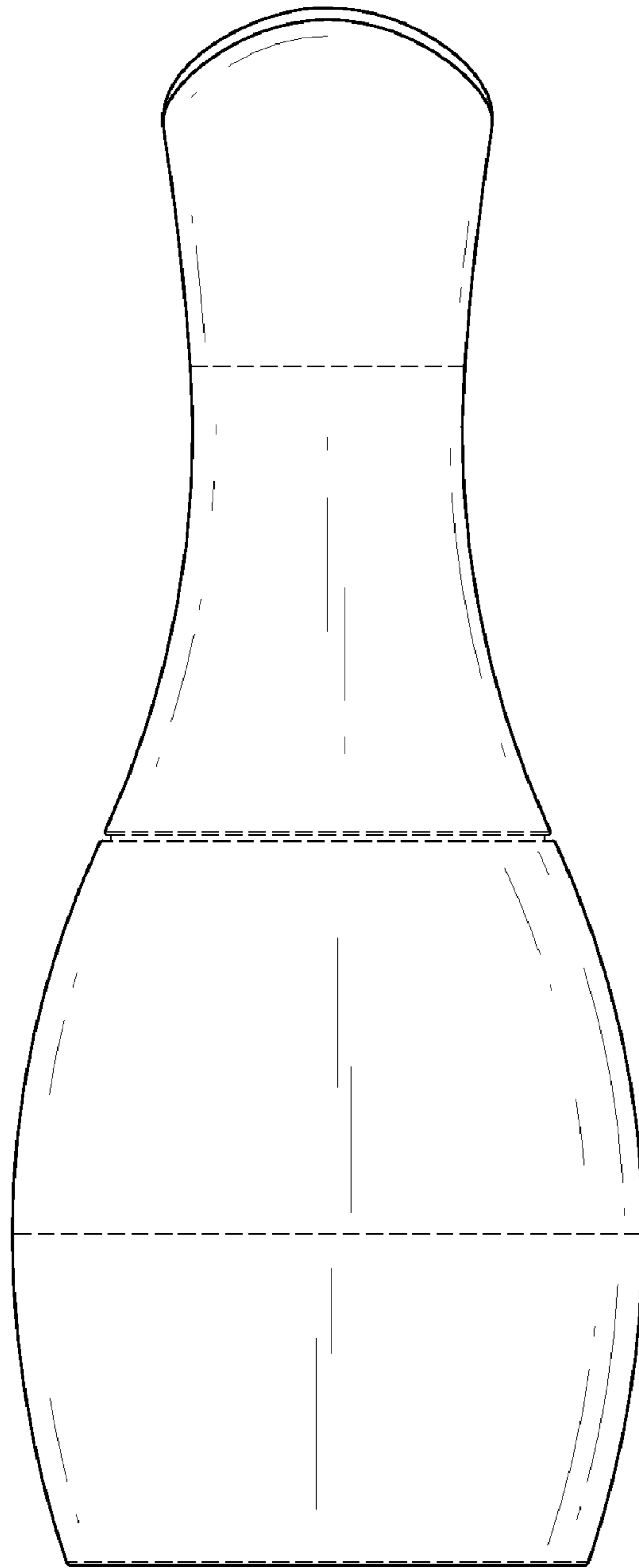
*FIG. 2*



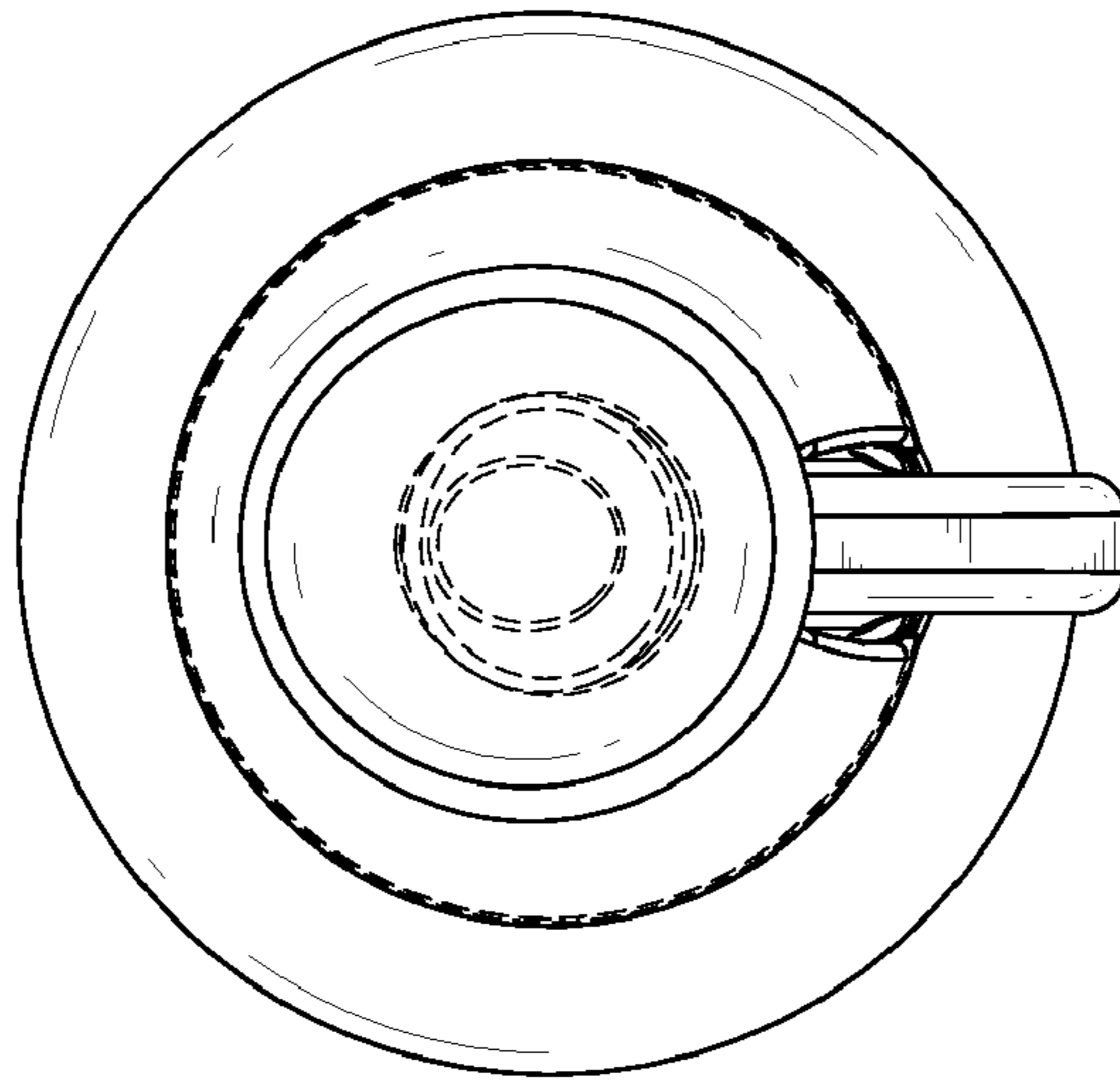
*FIG. 3*



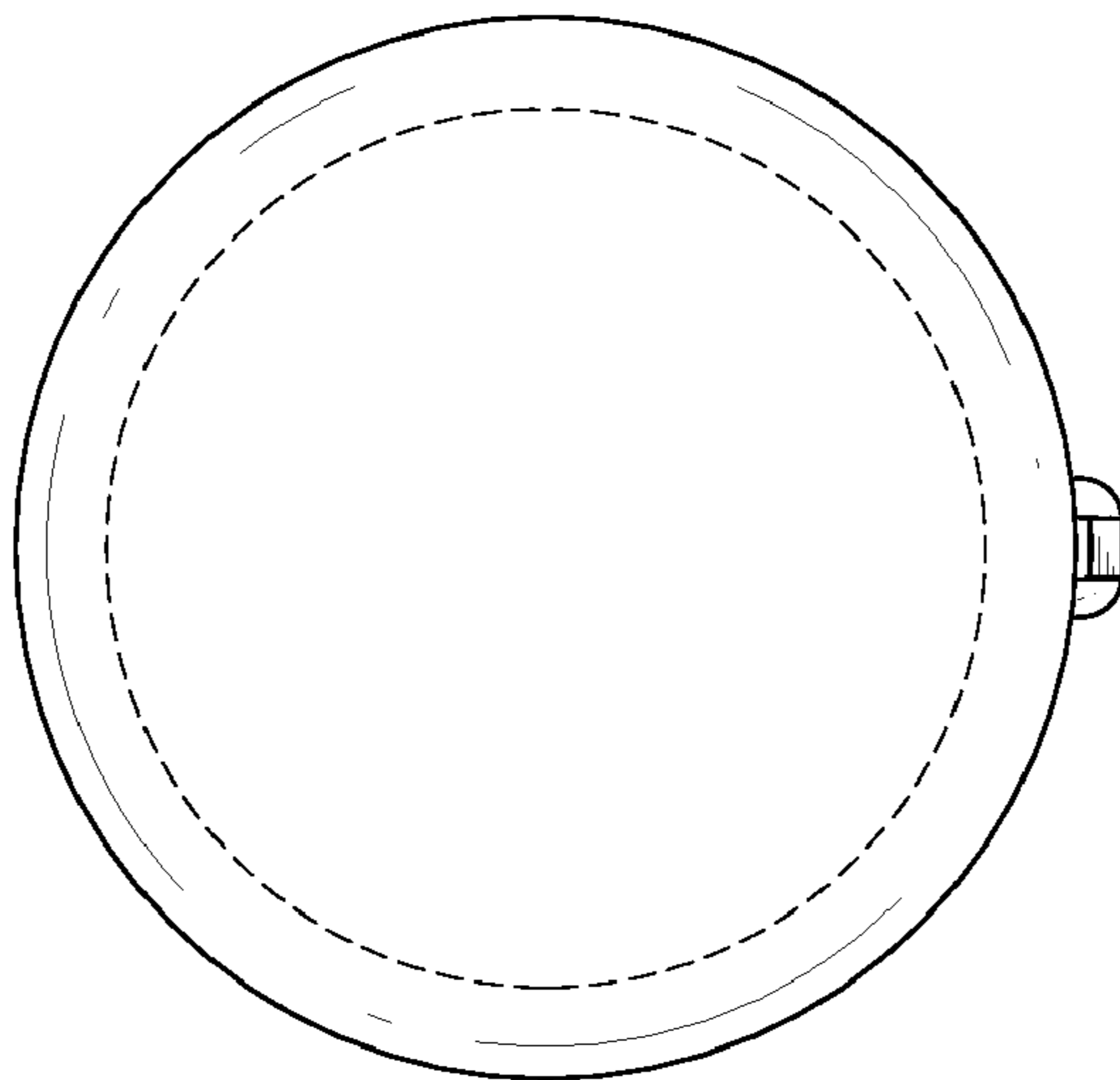
*FIG. 4*



*FIG. 5*



*FIG. 6*



*FIG. 7*