



US00D566484S

(12) **United States Design Patent**
George

(10) **Patent No.:** **US D566,484 S**
(45) **Date of Patent:** **** Apr. 15, 2008**

(54) **FOOD CONTAINER**

(57) **CLAIM**

(75) Inventor: **Sarah Danger George**, Seattle, WA
(US)

The ornamental design for a food container, as shown and described.

(73) Assignee: **Pacific Market International, LLC**,
Seattle, WA (US)

DESCRIPTION

(**) Term: **14 Years**

FIG. 1 is a top perspective view of a food container showing my new design.

(21) Appl. No.: **29/280,989**

FIG. 2 is a rear elevational view thereof.

(22) Filed: **Jun. 12, 2007**

FIG. 3 is a front elevational view thereof.

(51) **LOC (8) Cl.** **07-07**

FIG. 4 is a left side rear elevational view thereof.

(52) **U.S. Cl.** **D7/629; D3/294; D7/709**

FIG. 5 is a right side rear elevational view thereof.

(58) **Field of Classification Search** D7/601,
D7/602, 629, 630, 709, 710; D3/201, 204–206,
D3/273, 274, 276, 294, 281; 190/100, 115–118,
190/900; 206/216, 223, 541–549

FIG. 6 is a top plan view thereof.

FIG. 7 is a bottom plan view thereof.

See application file for complete search history.

FIG. 8 is a top perspective view of a second embodiment thereof.

FIG. 9 is a rear elevational view thereof.

FIG. 10 is a front elevational view thereof.

(56) **References Cited**

U.S. PATENT DOCUMENTS

FIG. 11 is a left side rear elevational view thereof.

FIG. 12 is a right side rear elevational view thereof.

4,456,105	A *	6/1984	Seynhaeve	190/115
D302,904	S *	8/1989	Dunkfeld, Jr.	D7/709
D309,981	S *	8/1990	French et al.	D3/295
D319,947	S *	9/1991	Ryan	D7/709
D349,633	S *	8/1994	Krupa	D7/709
5,390,797	A *	2/1995	Smalley et al.	206/542
D363,197	S *	10/1995	Burnett	D7/710
5,595,302	A *	1/1997	Maydwell et al.	206/541
5,671,846	A *	9/1997	Frank	206/541
5,839,553	A *	11/1998	Dorsam	190/109
5,881,850	A *	3/1999	Murdoch	190/110
D472,774	S *	4/2003	Pelstring et al.	D7/629
D522,811	S *	6/2006	Martinez et al.	D7/607

FIG. 13 is a top plan view thereof.

FIG. 14 is a bottom plan view thereof.

FIG. 15 is a top perspective view of a third embodiment thereof.

FIG. 16 is a rear elevational view thereof.

FIG. 17 is a front elevational view thereof.

FIG. 18 is a left side rear elevational view thereof.

FIG. 19 is a right side rear elevational view thereof.

FIG. 20 is a top plan view thereof; and,

FIG. 21 is a bottom plan view thereof.

* cited by examiner

The broken lines are for illustrative purposes only and form no part of the claimed design.

Primary Examiner—Terry A Wallace

(74) *Attorney, Agent, or Firm*—Davis Wright Tremaine
LLP; George C. Rondeau, Jr.

1 Claim, 15 Drawing Sheets

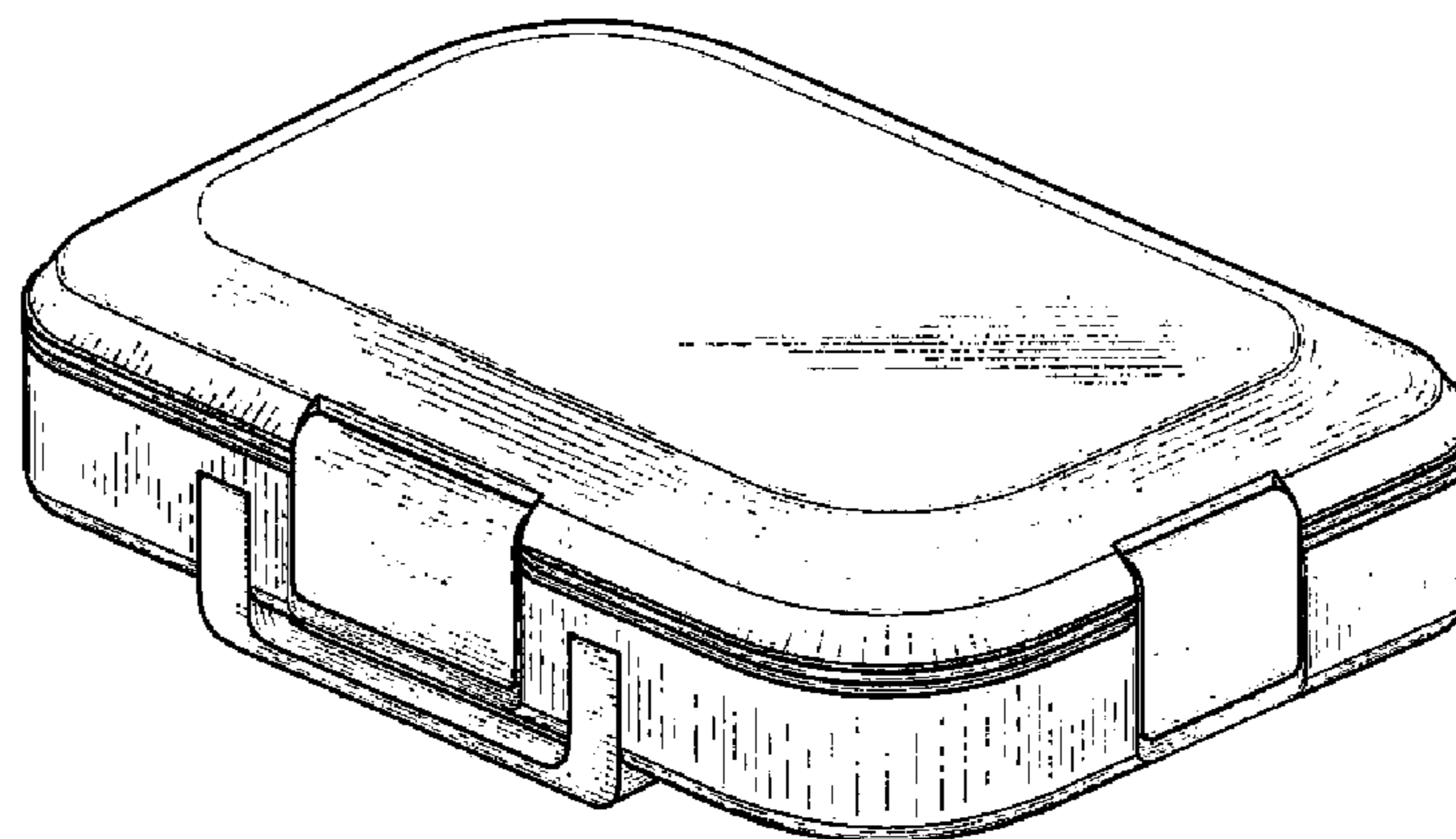

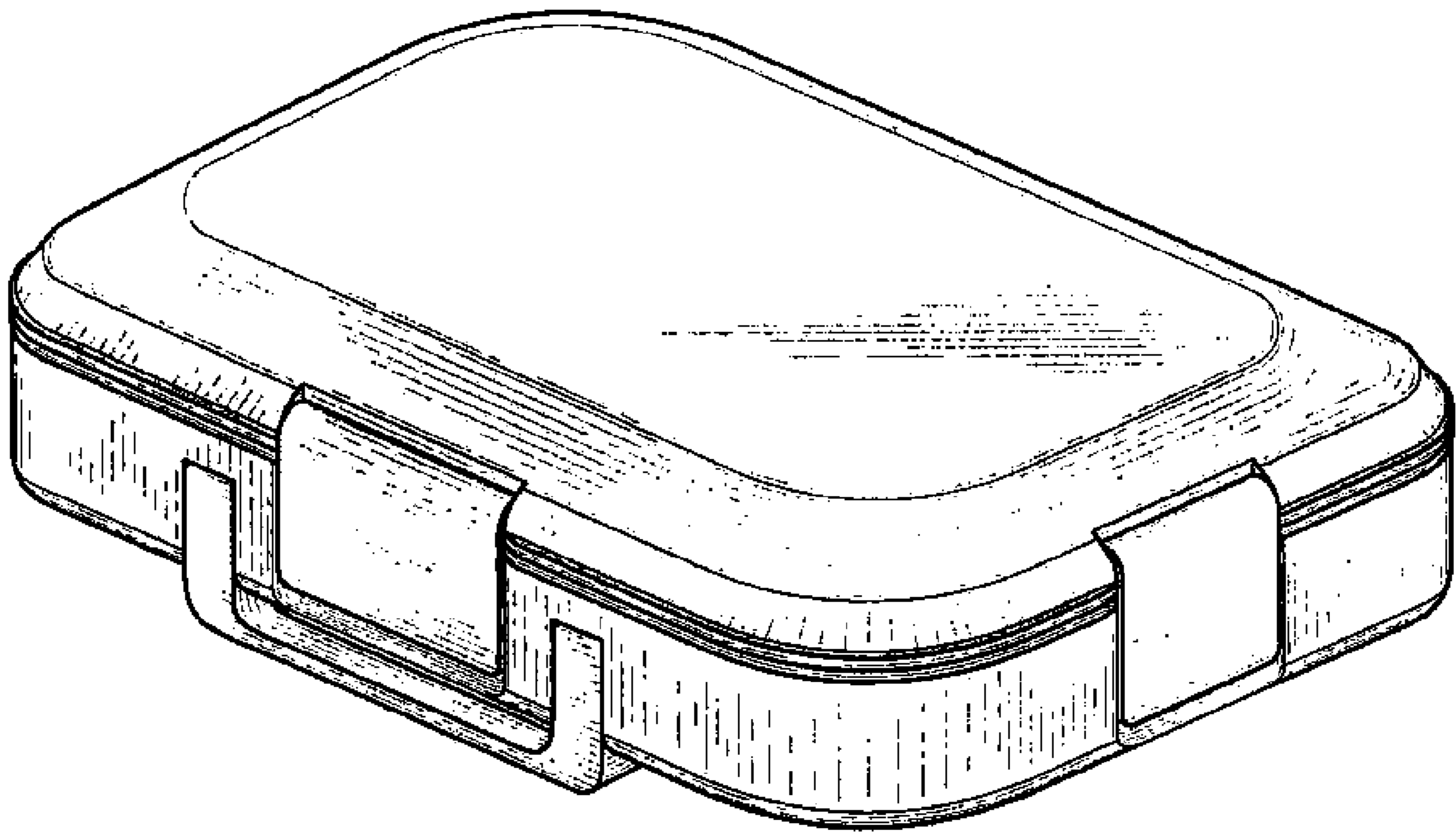

Fig. 1

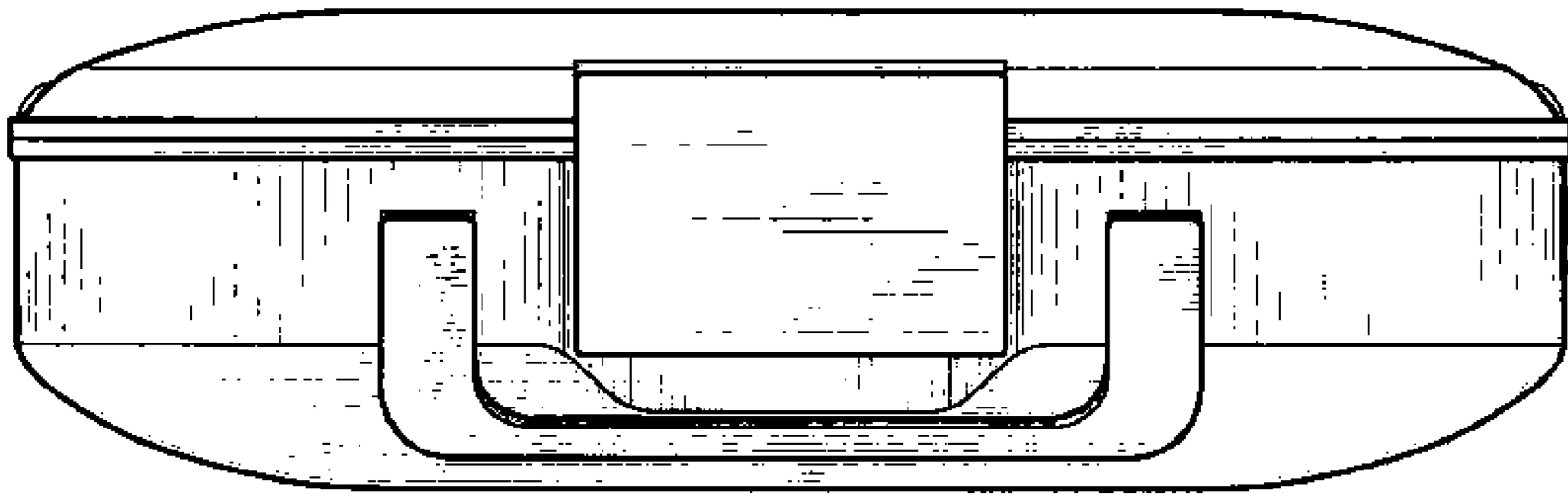

Fig. 2

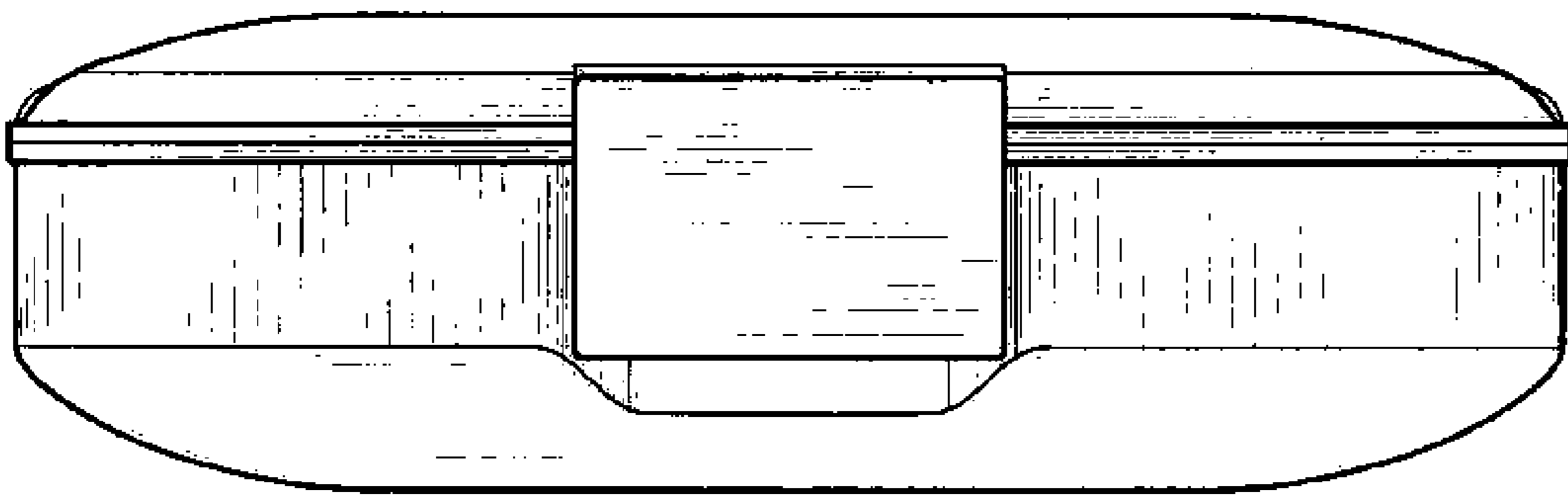

Fig. 3

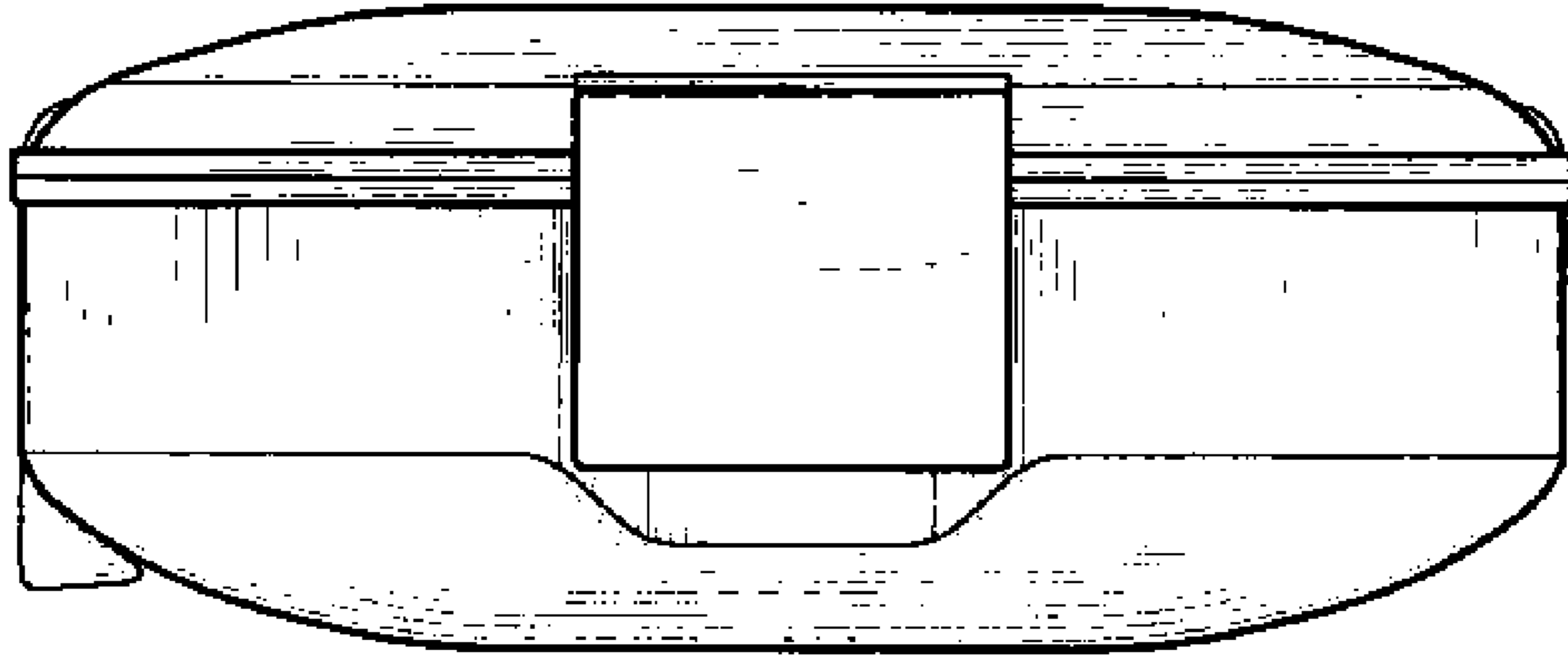

Fig. 4

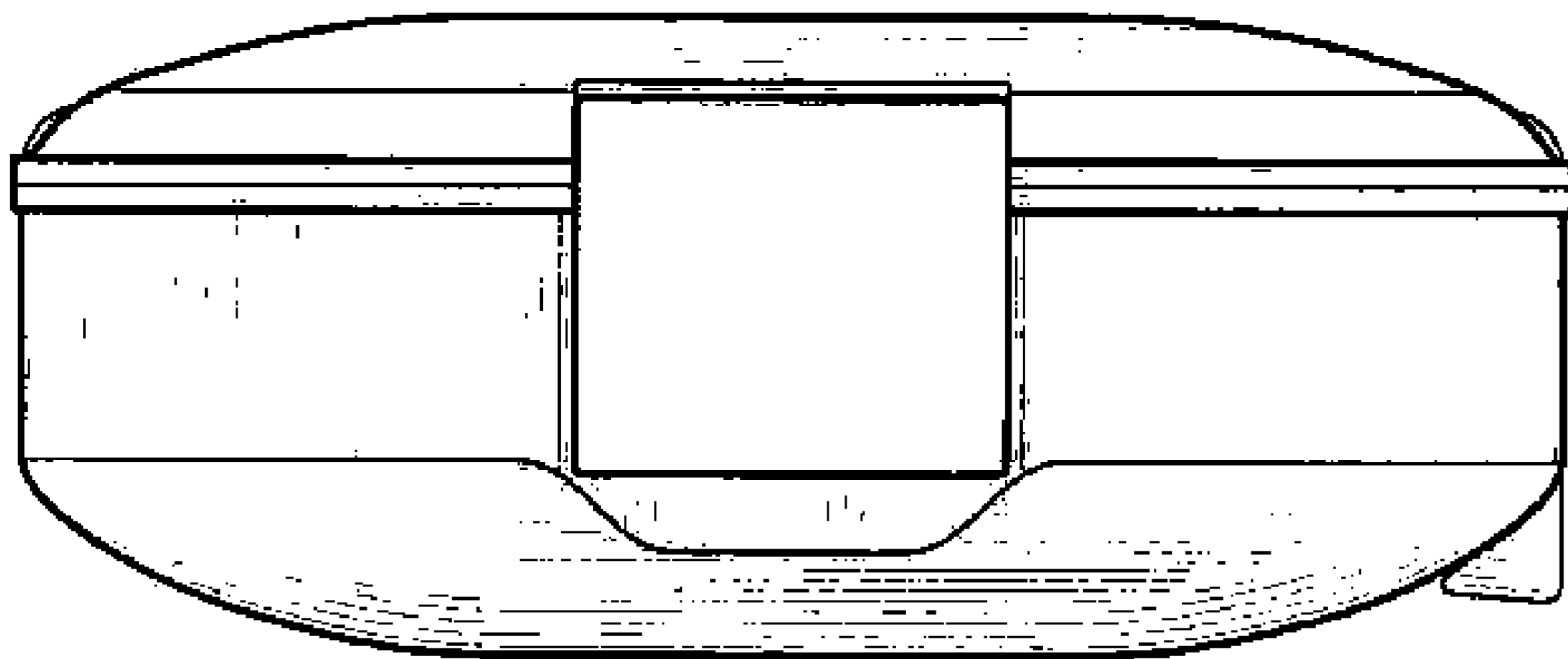

Fig. 5

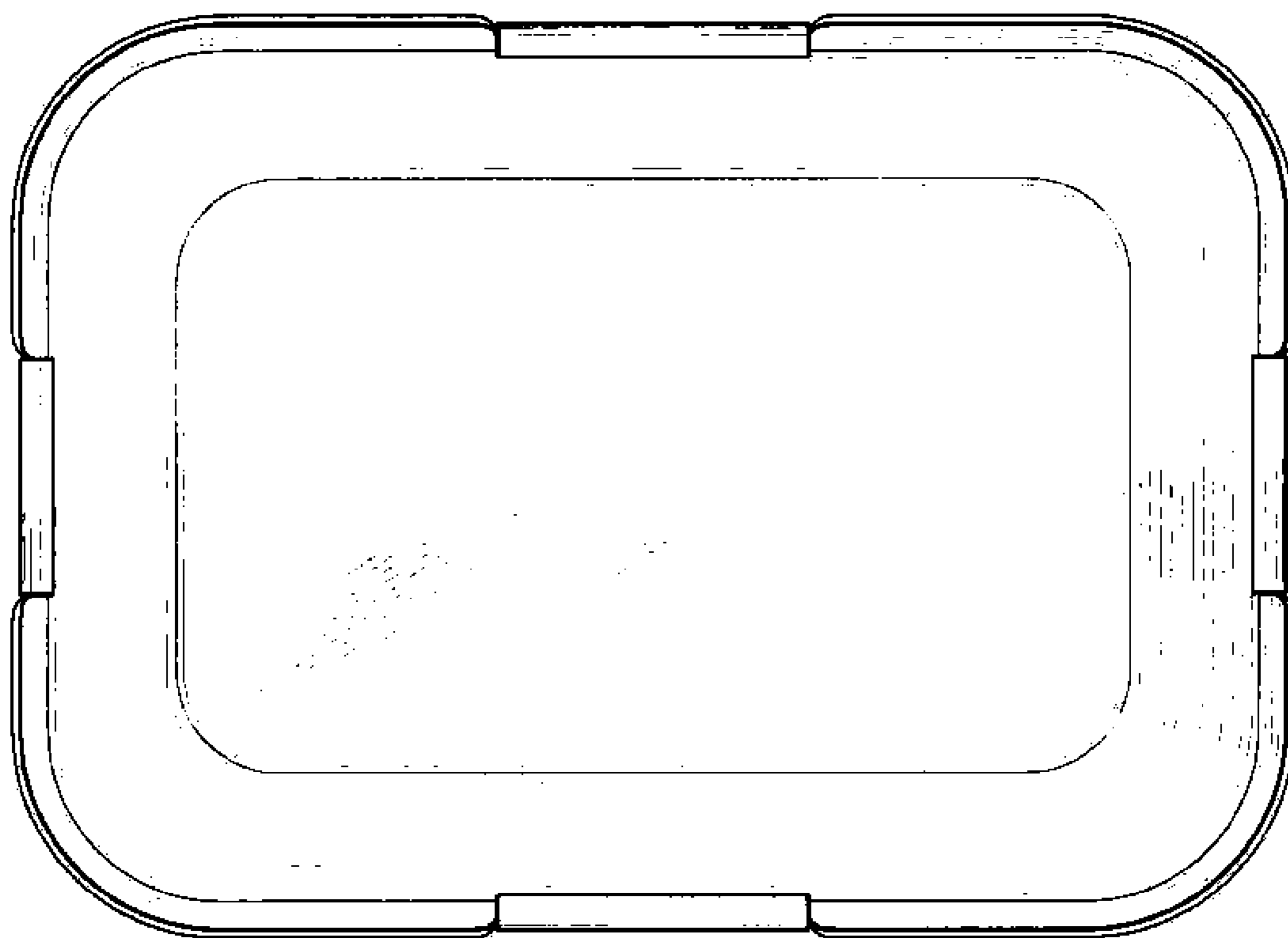

Fig. 6

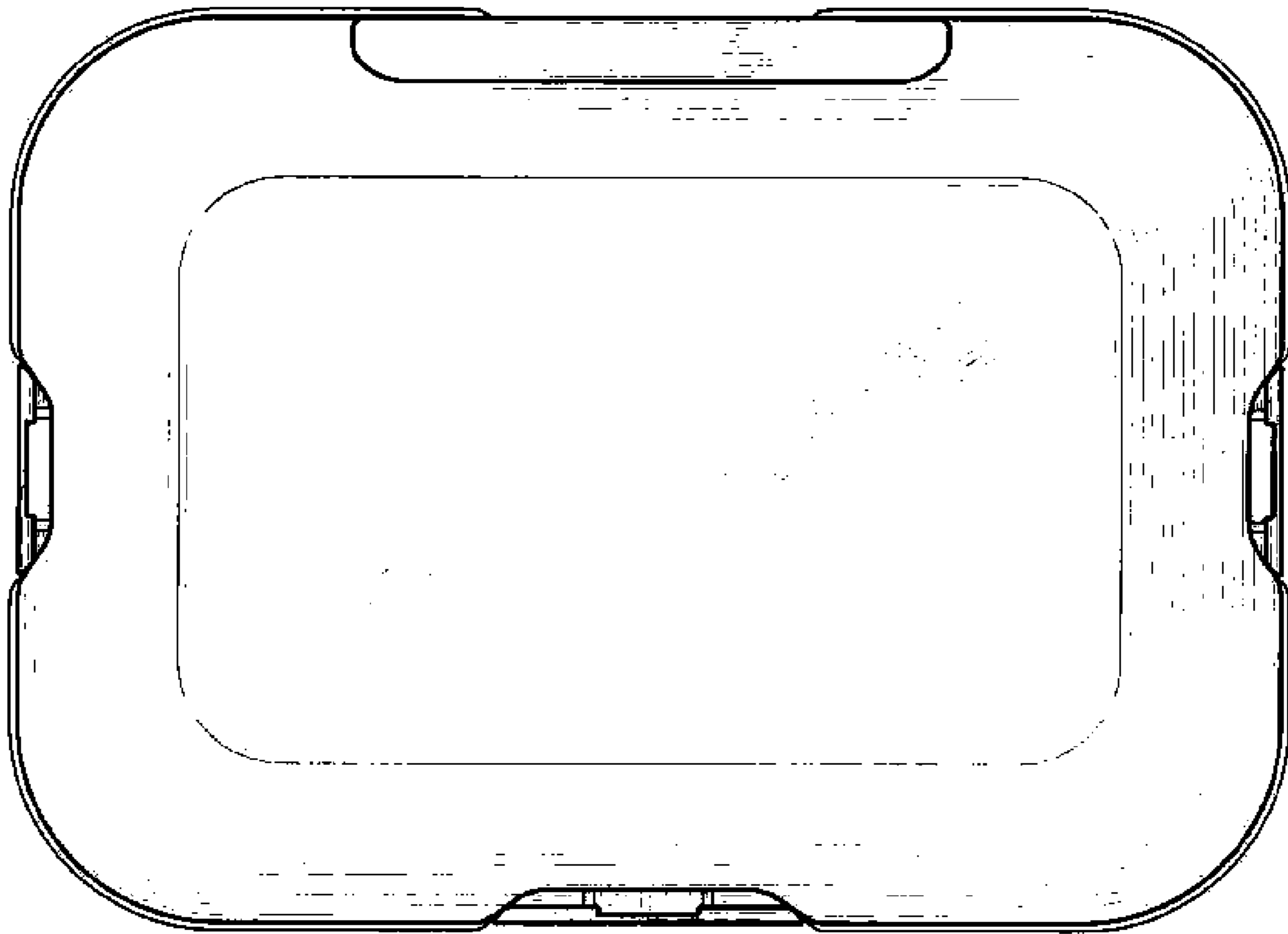

Fig. 7

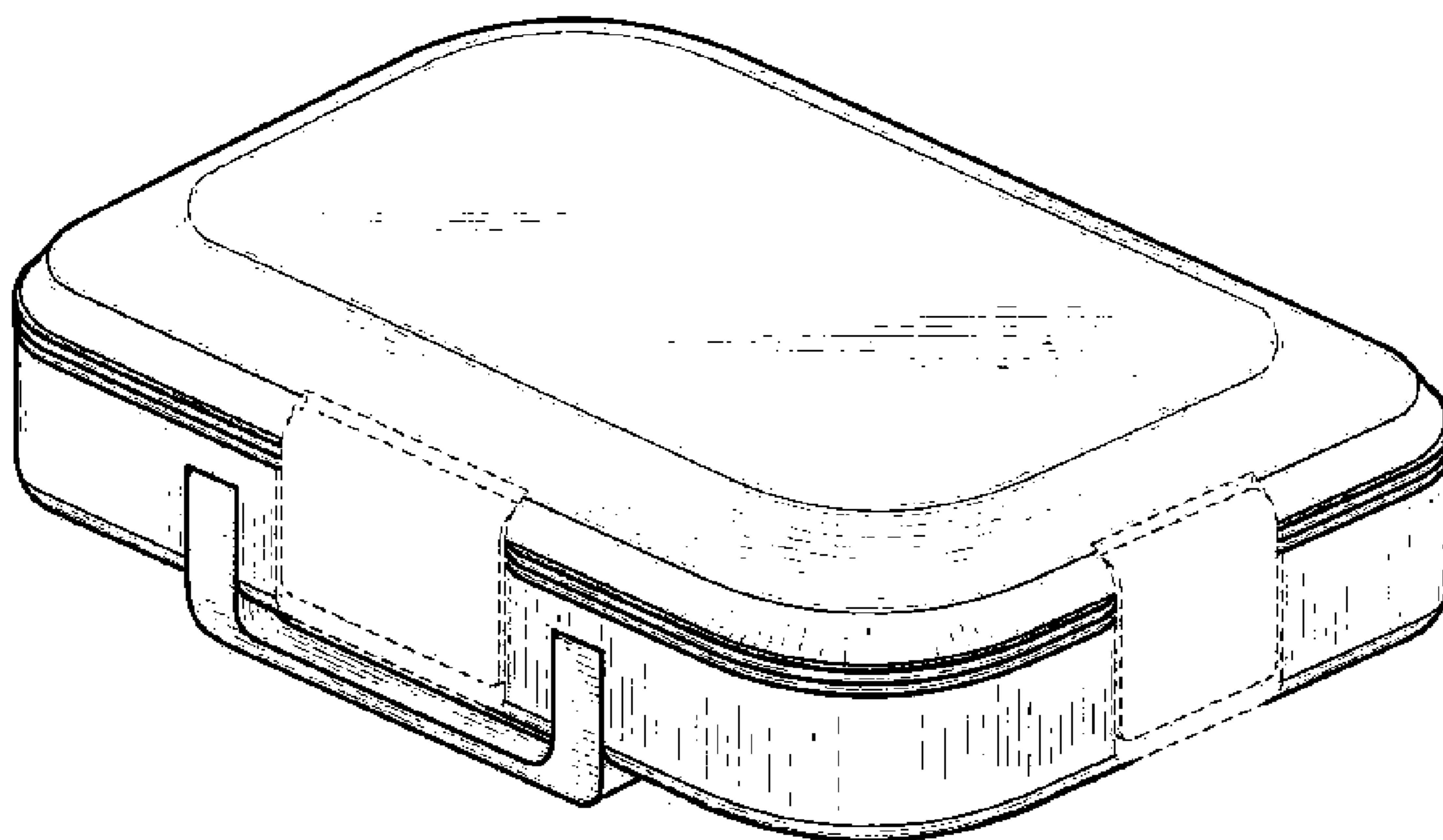

Fig. 8

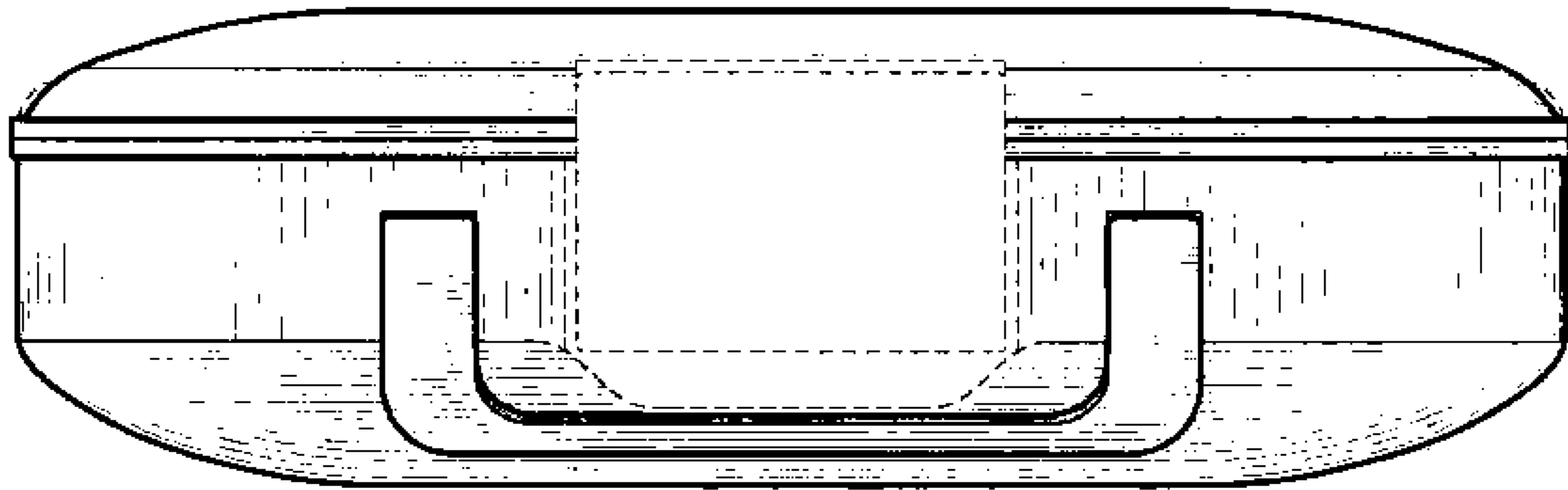

Fig. 9

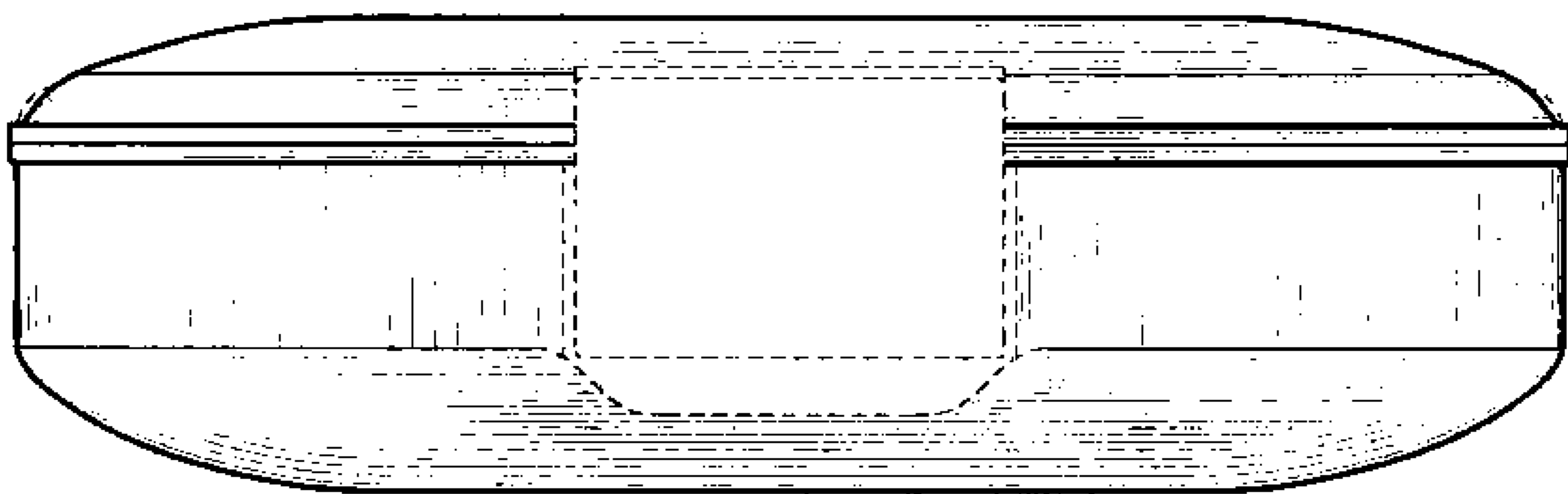

Fig. 10

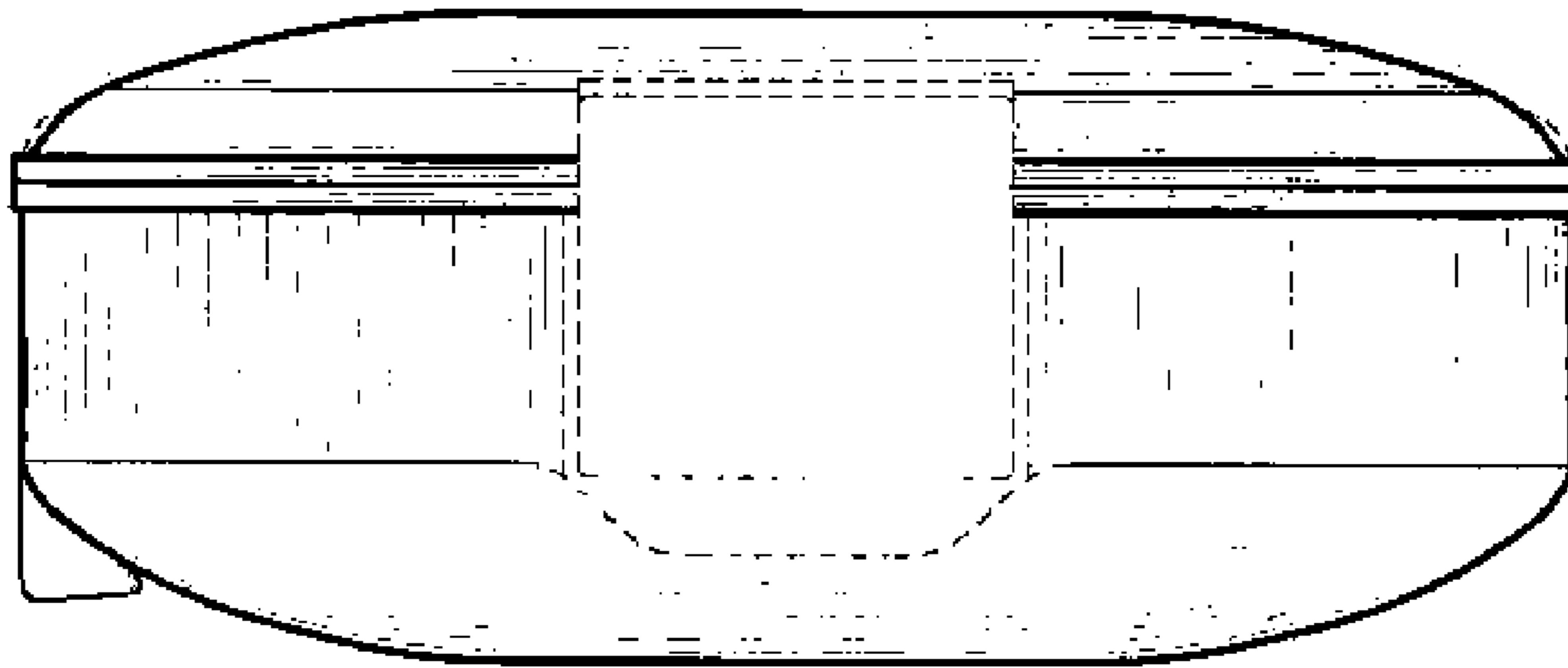

Fig. 11

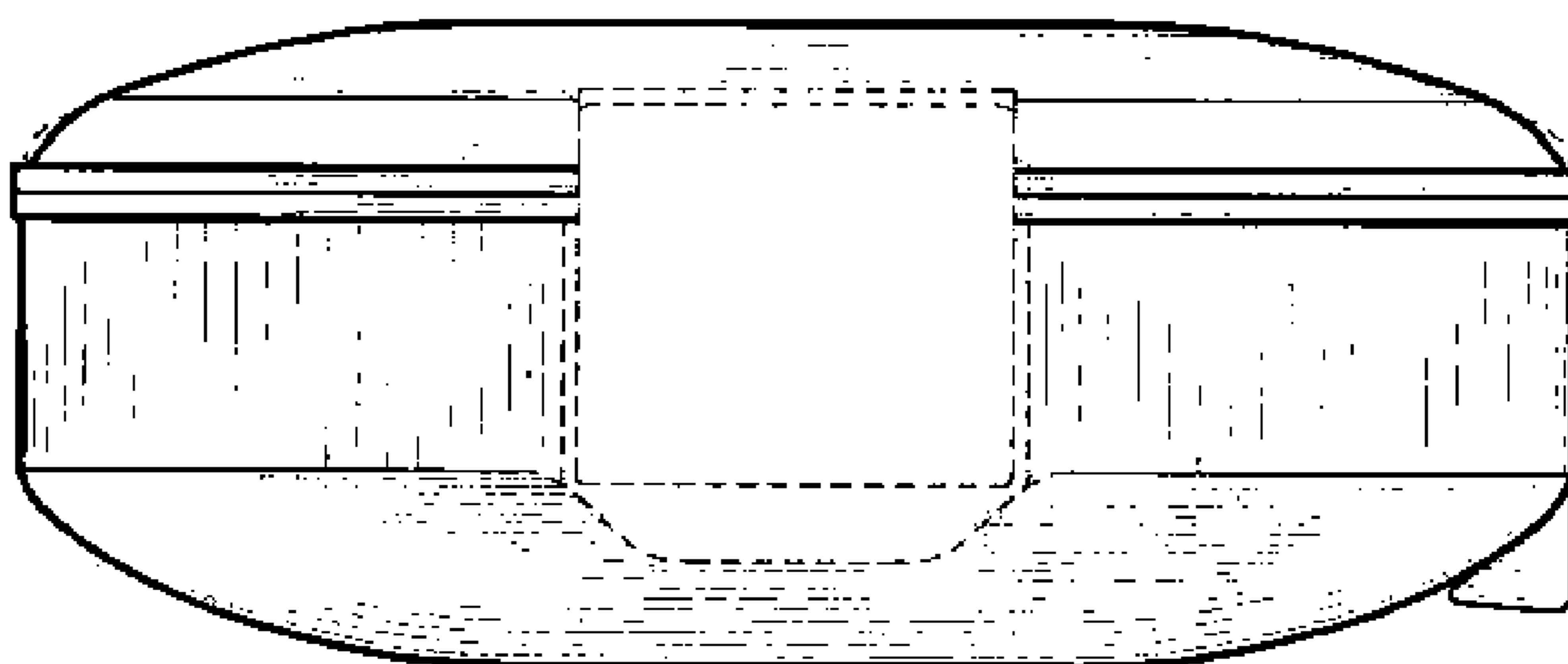

Fig. 12

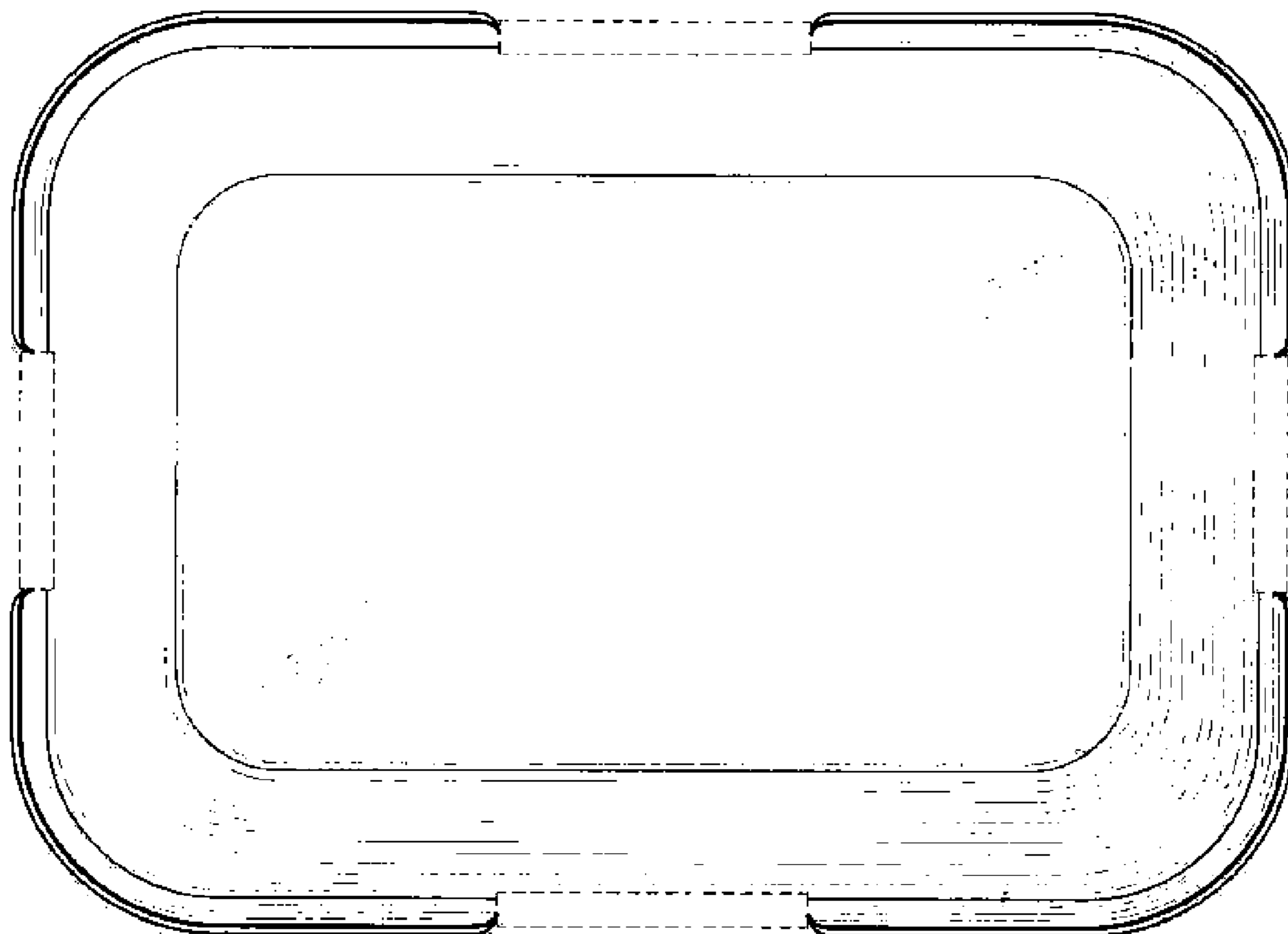

Fig. 13

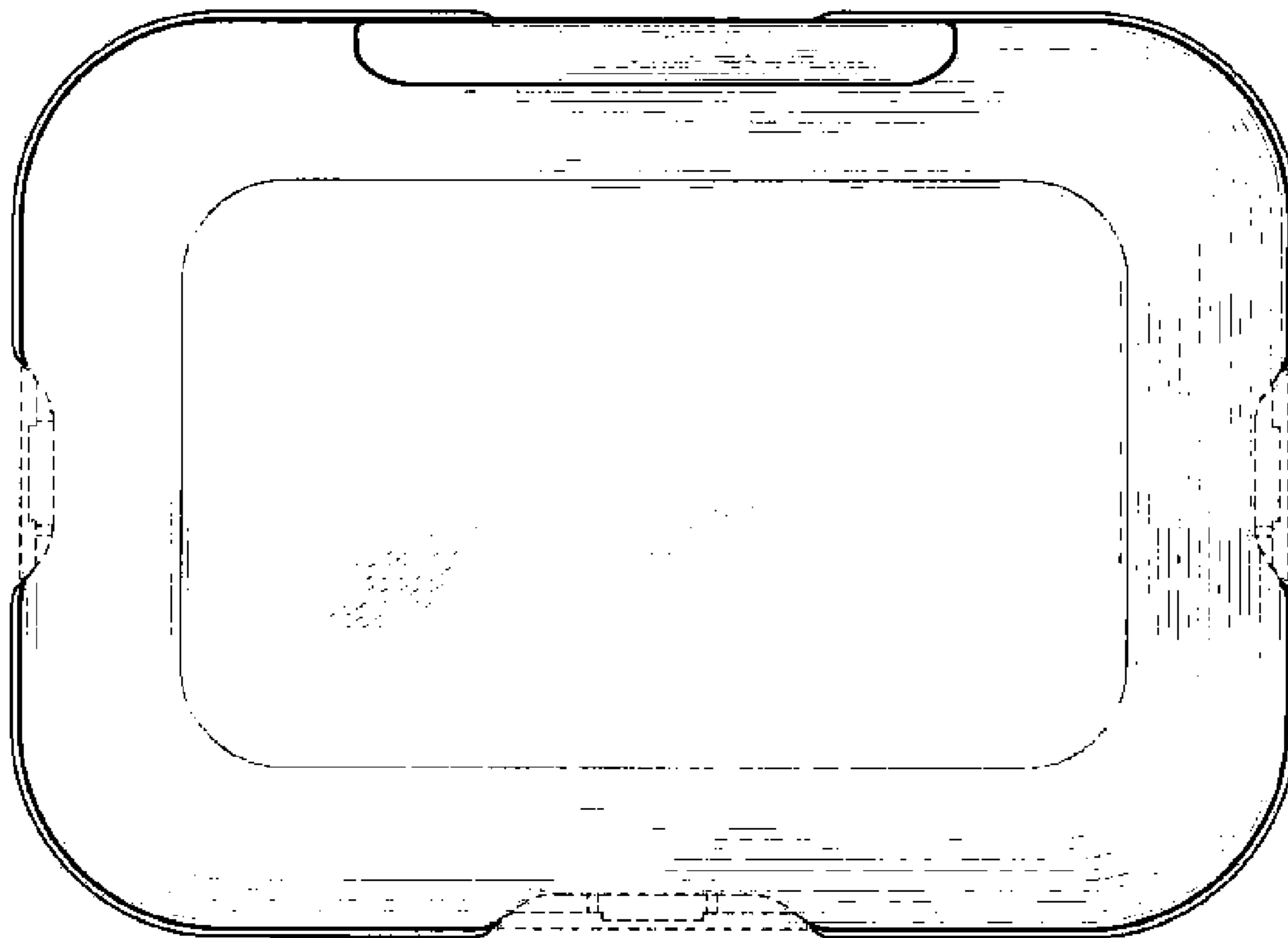

Fig. 14

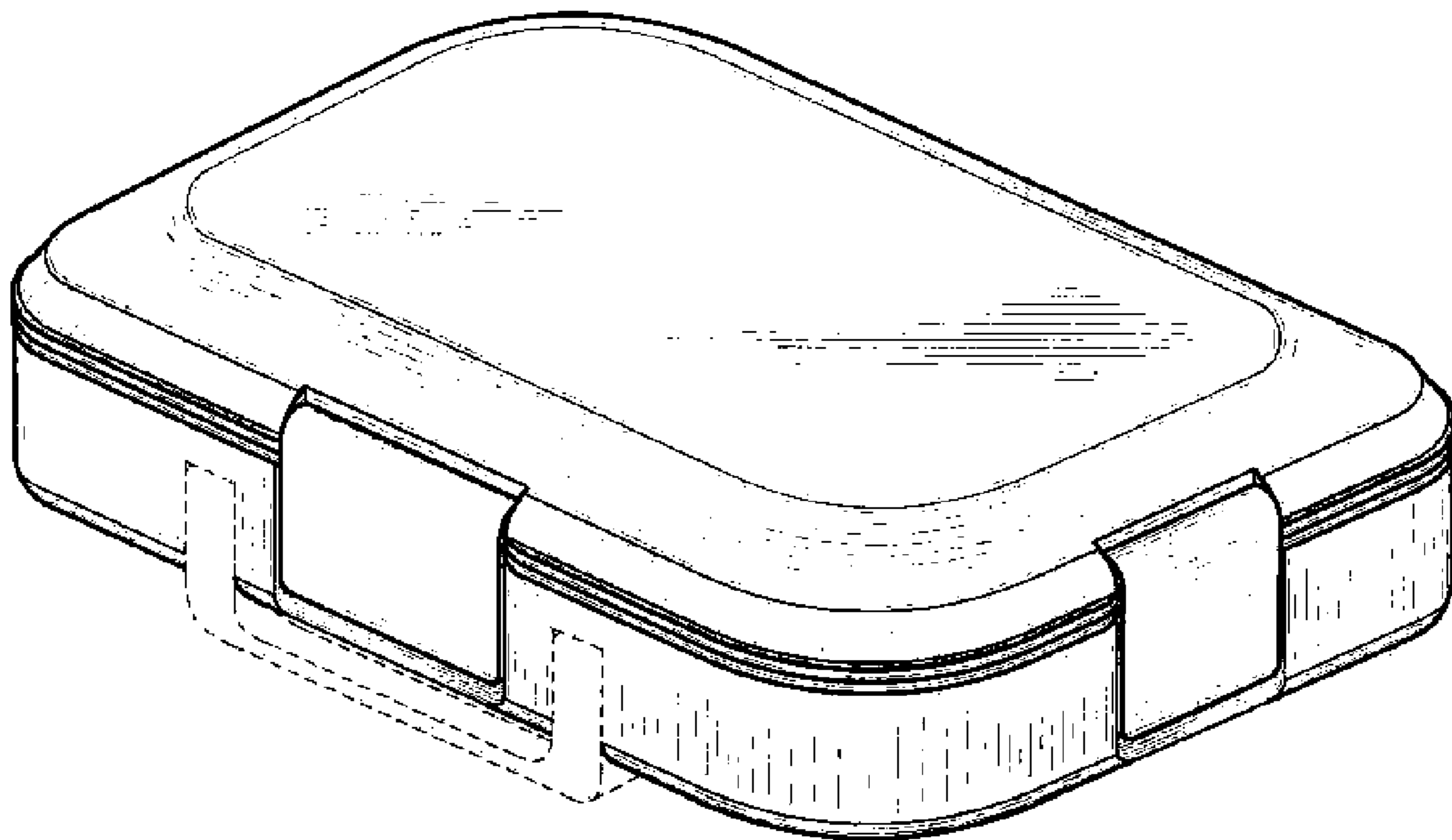

Fig. 15

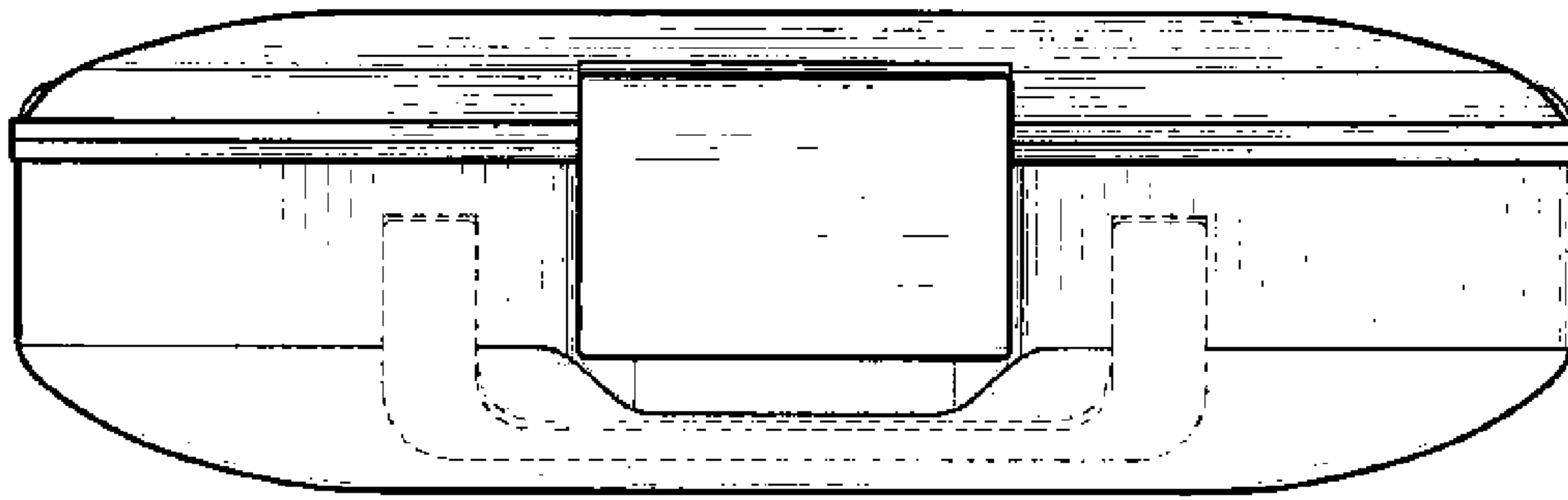

Fig. 16

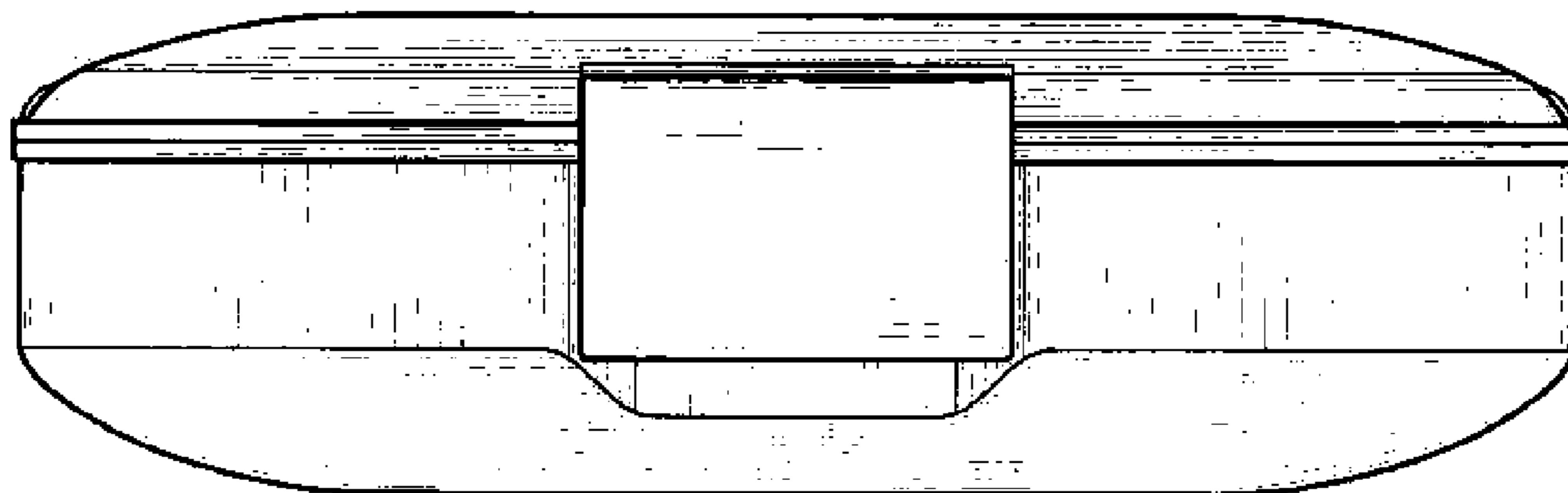

Fig. 17

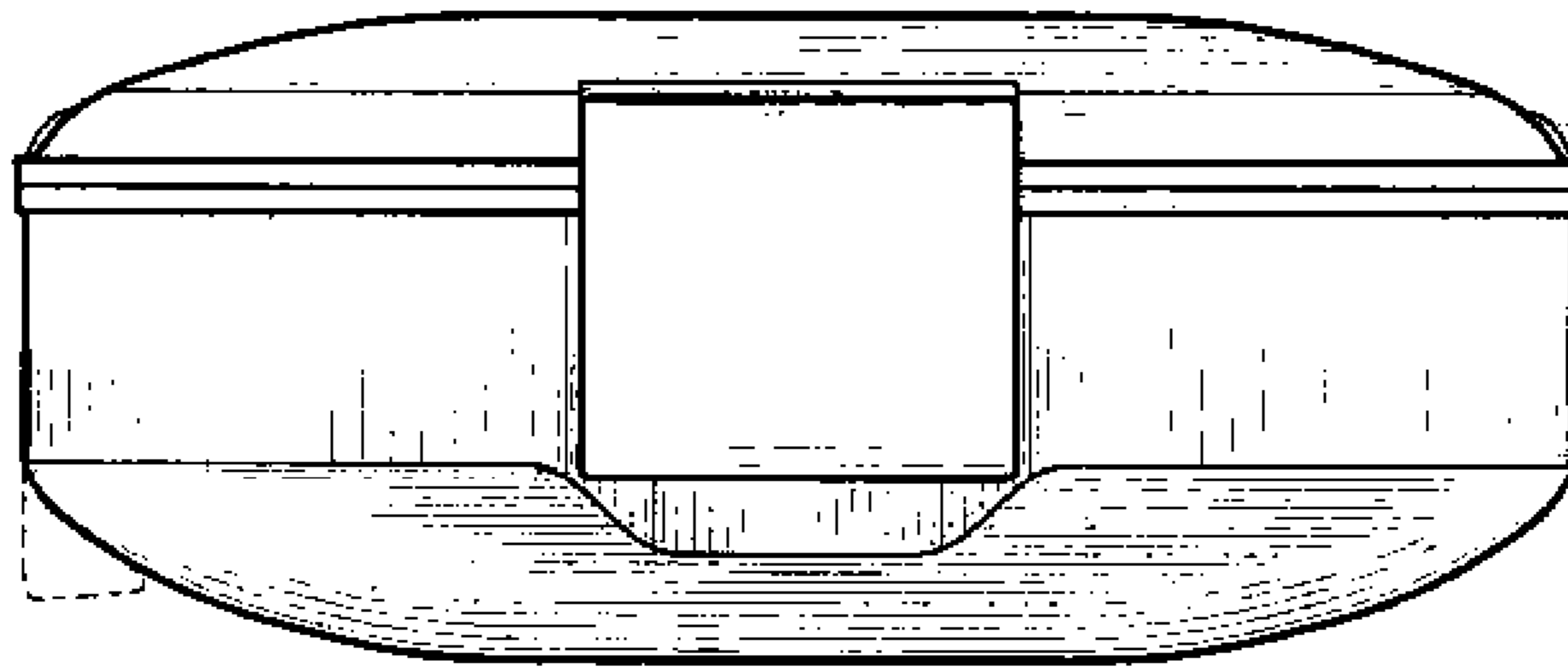

Fig. 18

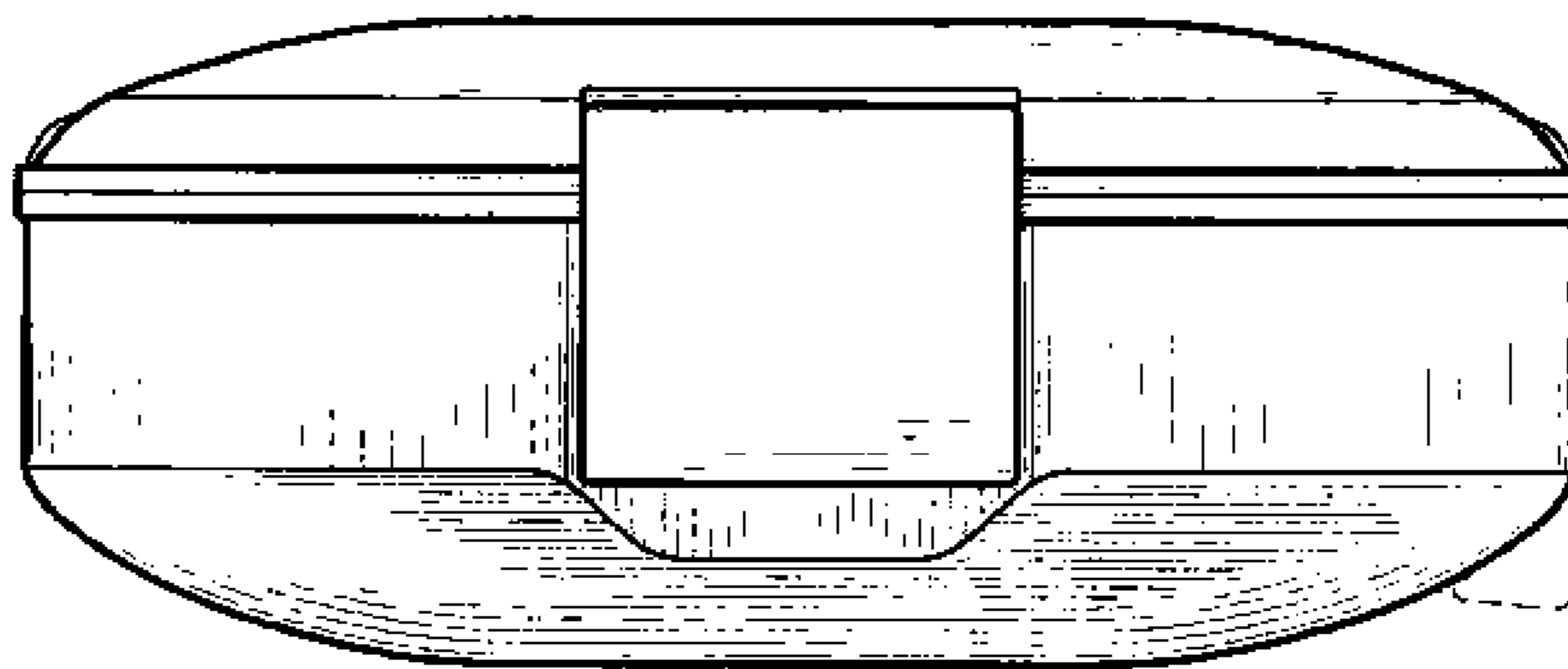

Fig. 19

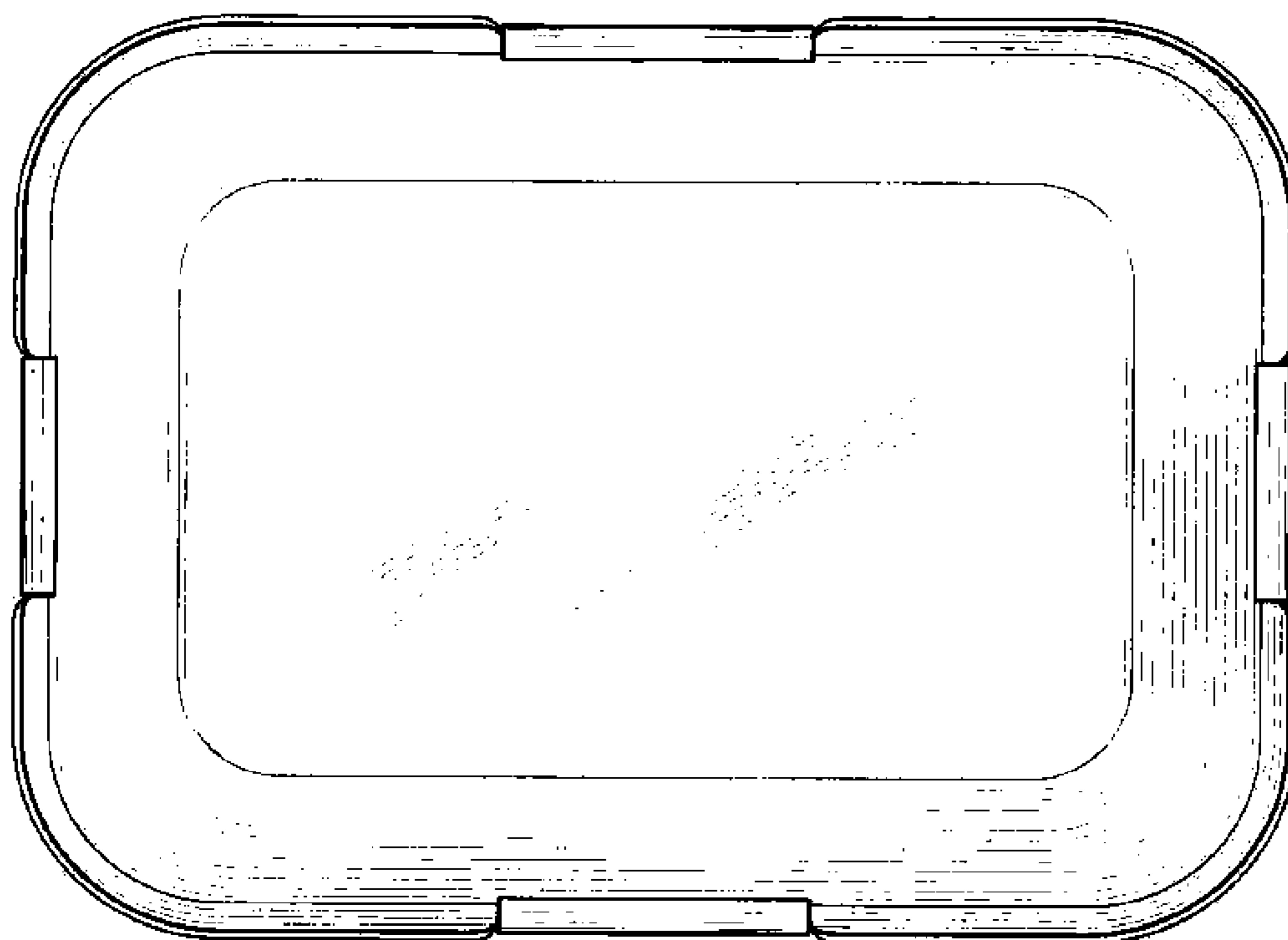

Fig. 20

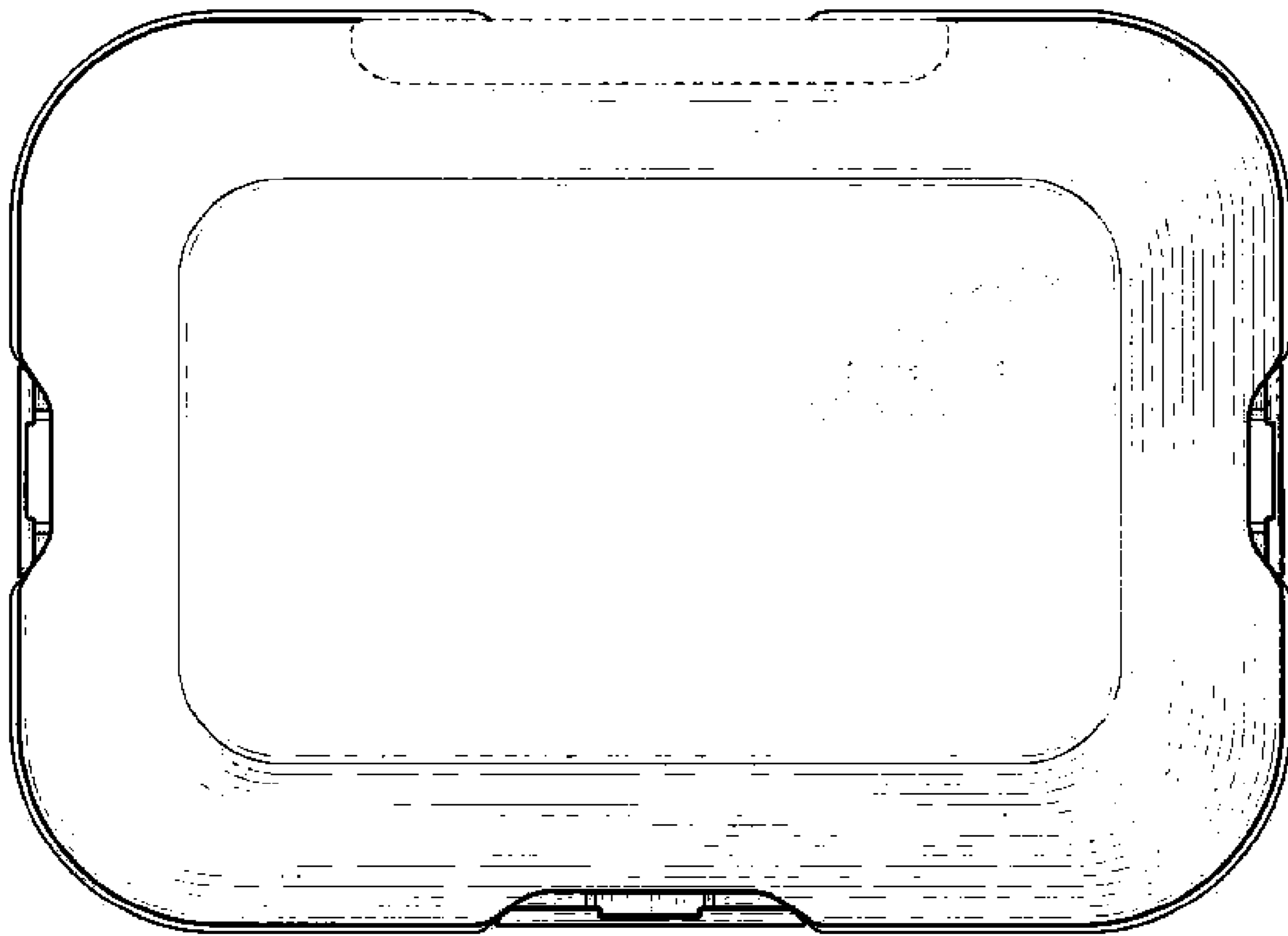

Fig. 21