

US00D566443S

(12) **United States Design Patent**
Hutchins

(10) **Patent No.:** **US D566,443 S**

(45) **Date of Patent:** **** Apr. 15, 2008**

(54) **TOOTHBRUSH CADDY**

Primary Examiner—Brian N Vinson

(76) **Inventor:** **Lorraine Hutchins**, 8759 37th. Ave.,
Kenosha, WI (US) 53142

(57) **CLAIM**

The ornamental design for a toothbrush caddy, as shown and described.

(**) **Term:** **14 Years**

(21) **Appl. No.:** **29/267,357**

DESCRIPTION

(22) **Filed:** **Oct. 12, 2006**

FIG. 1 is a front elevational view of a toothbrush caddy showing my new design;

(51) **LOC (8) Cl.** **23-04**

FIG. 2 is a right side elevational view thereof;

(52) **U.S. Cl.** **D6/534**

FIG. 3 is a top plan view thereof;

(58) **Field of Classification Search** D6/526–528,
D6/534; 206/208, 209, 228, 209.1, 361,
206/362.1, 362.2, 362.3; 211/13.1, 65–66,
211/70.6, 86.01, 87.01

FIG. 4 is a top, front, and right side isometric view thereof;

FIG. 5 is a front elevational view of the insert for the toothbrush caddy, with the exterior portion of the caddy omitted for clarity of illustration;

See application file for complete search history.

FIG. 6 is a right side elevational view thereof;

(56) **References Cited**

FIG. 7 is a top plan view thereof; and,

U.S. PATENT DOCUMENTS

FIG. 8 is a top, front, and right side isometric view thereof.

D324,792 S *	3/1992	McElroy	D6/528
5,769,245 A *	6/1998	Butler	211/13.1
D502,623 S *	3/2005	Minard et al.	D6/534

The broken-line disclosure is understood to be for illustrative purposes only and forms no part of the claimed design.

* cited by examiner

1 Claim, 2 Drawing Sheets

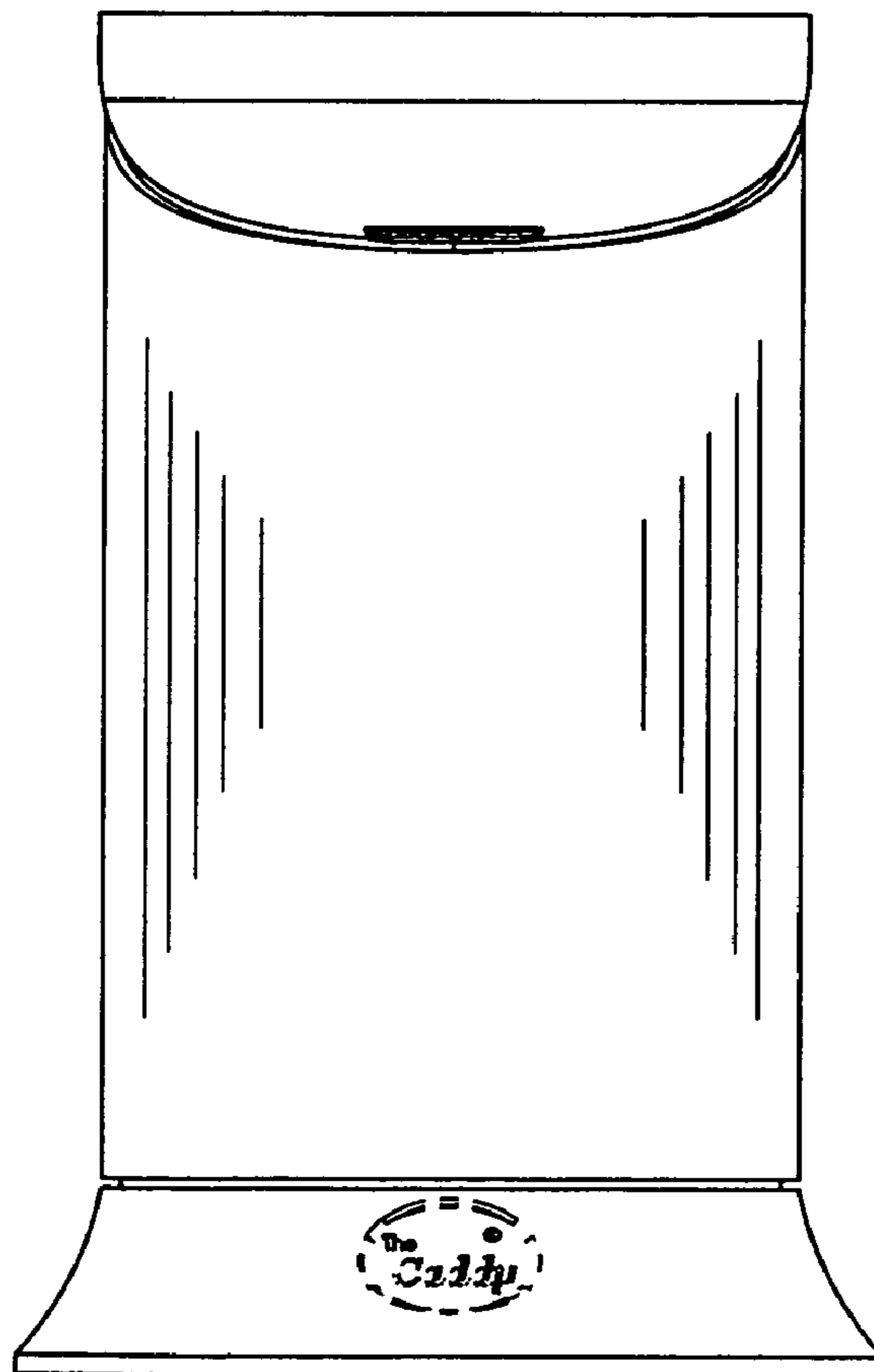

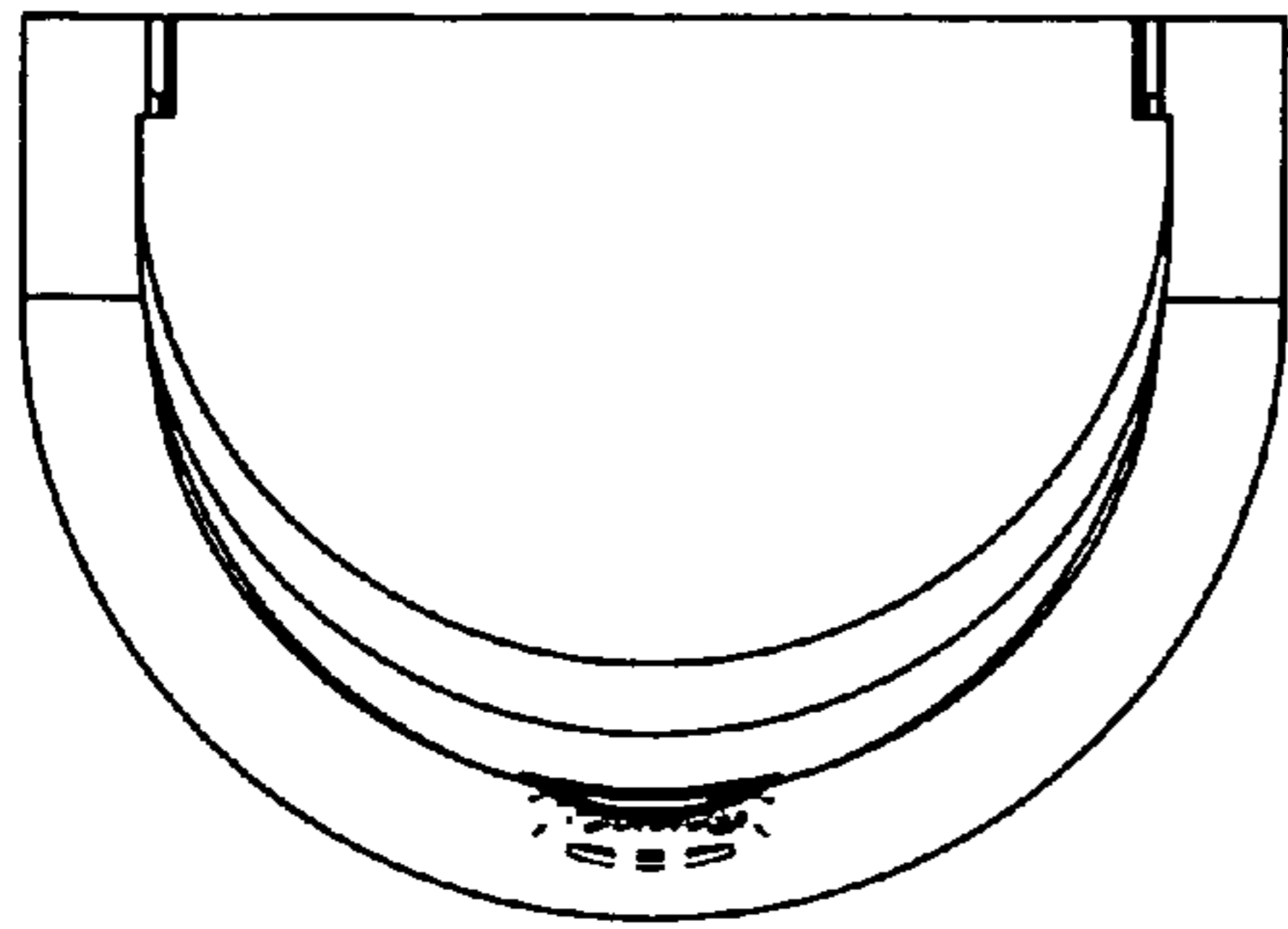

FIG. 3

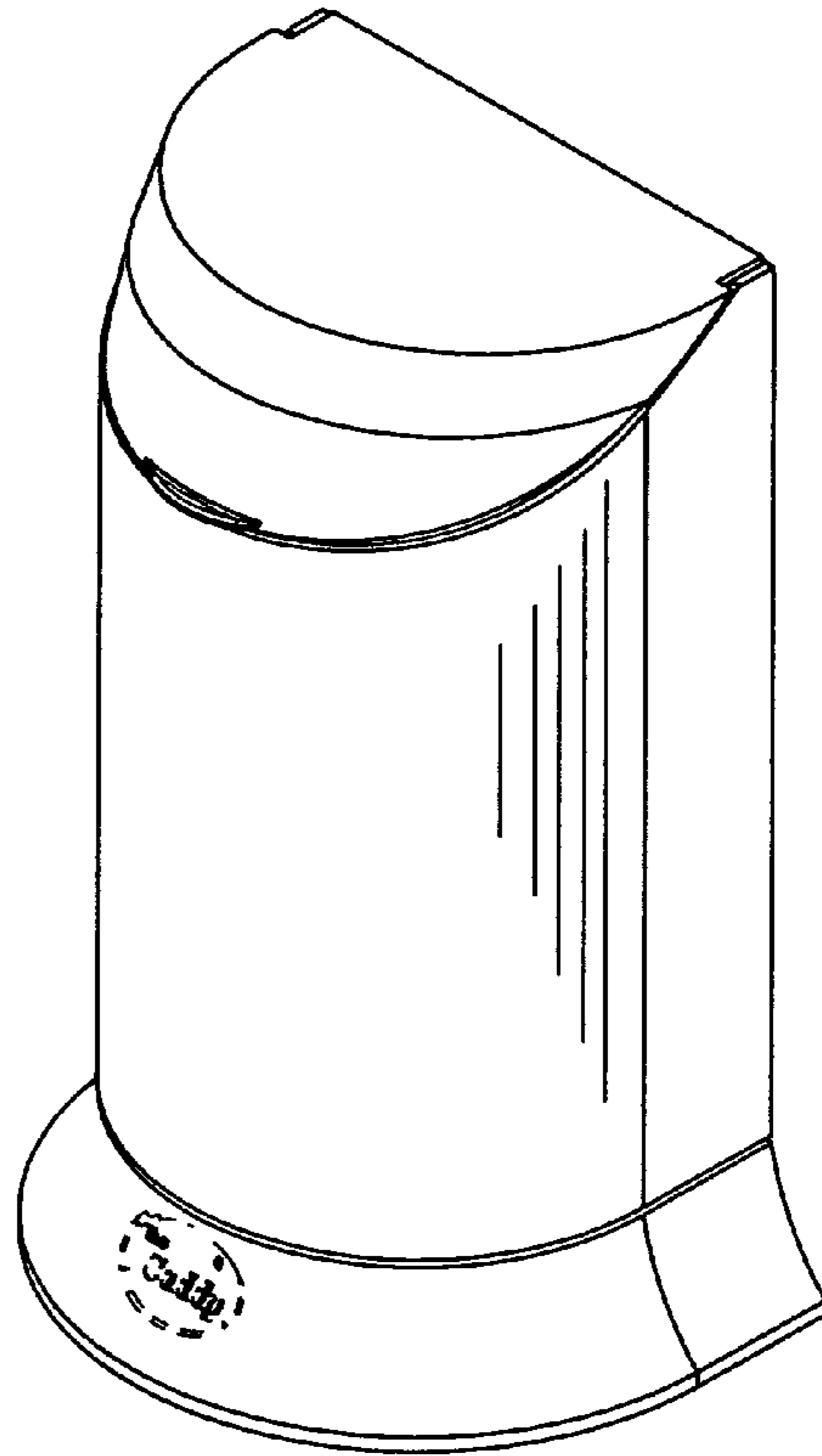

FIG. 4

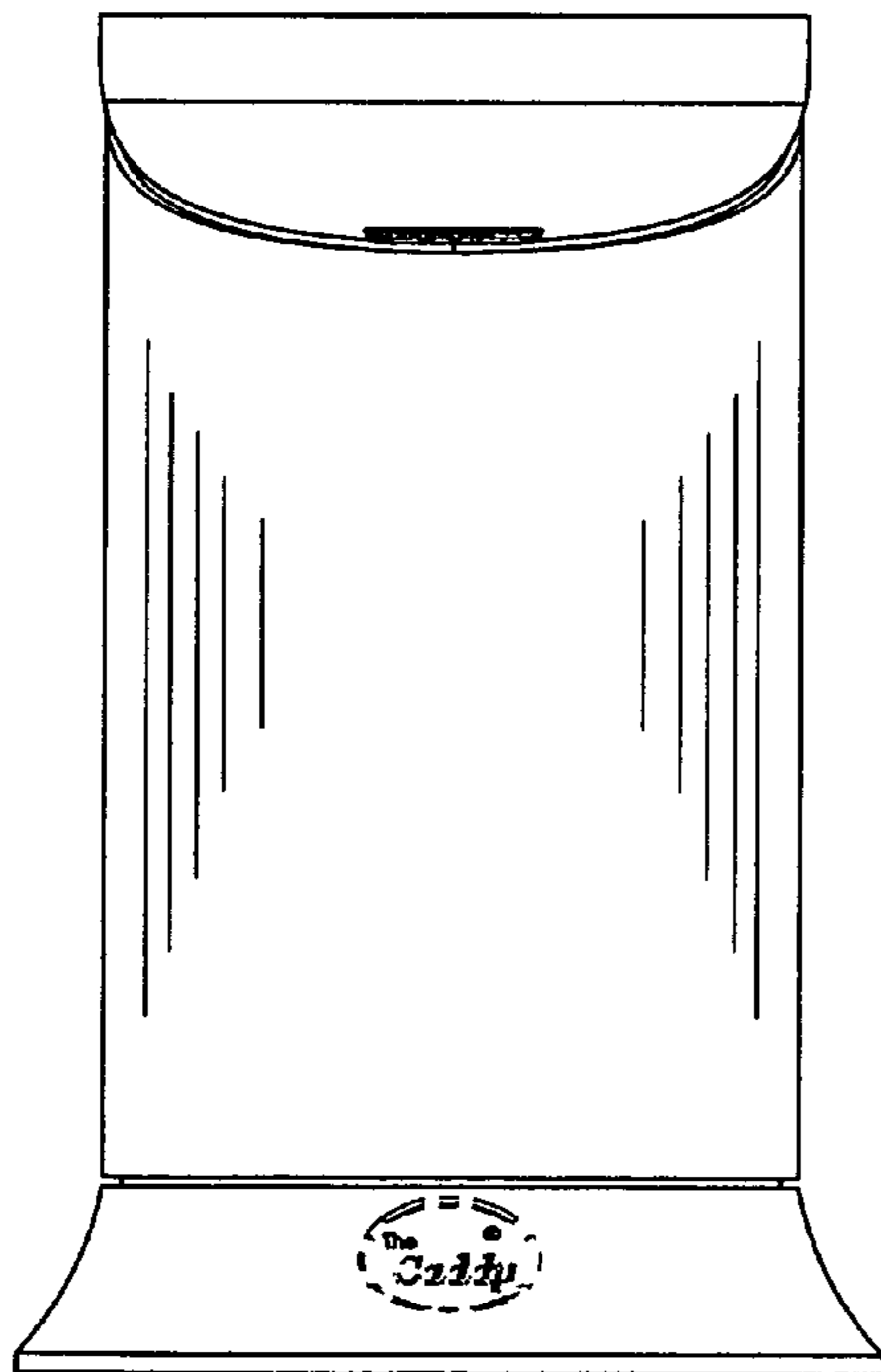

FIG. 1

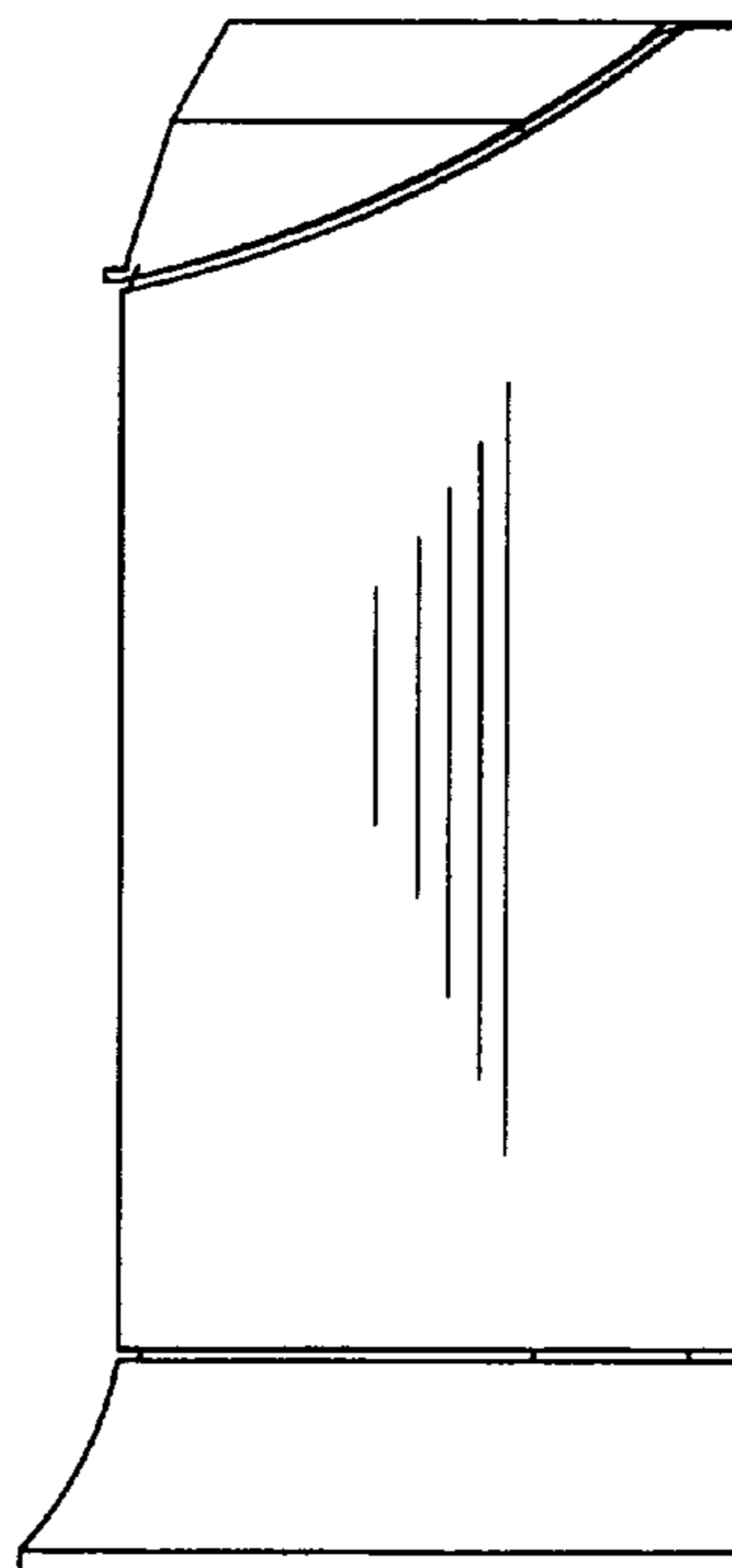

FIG. 2

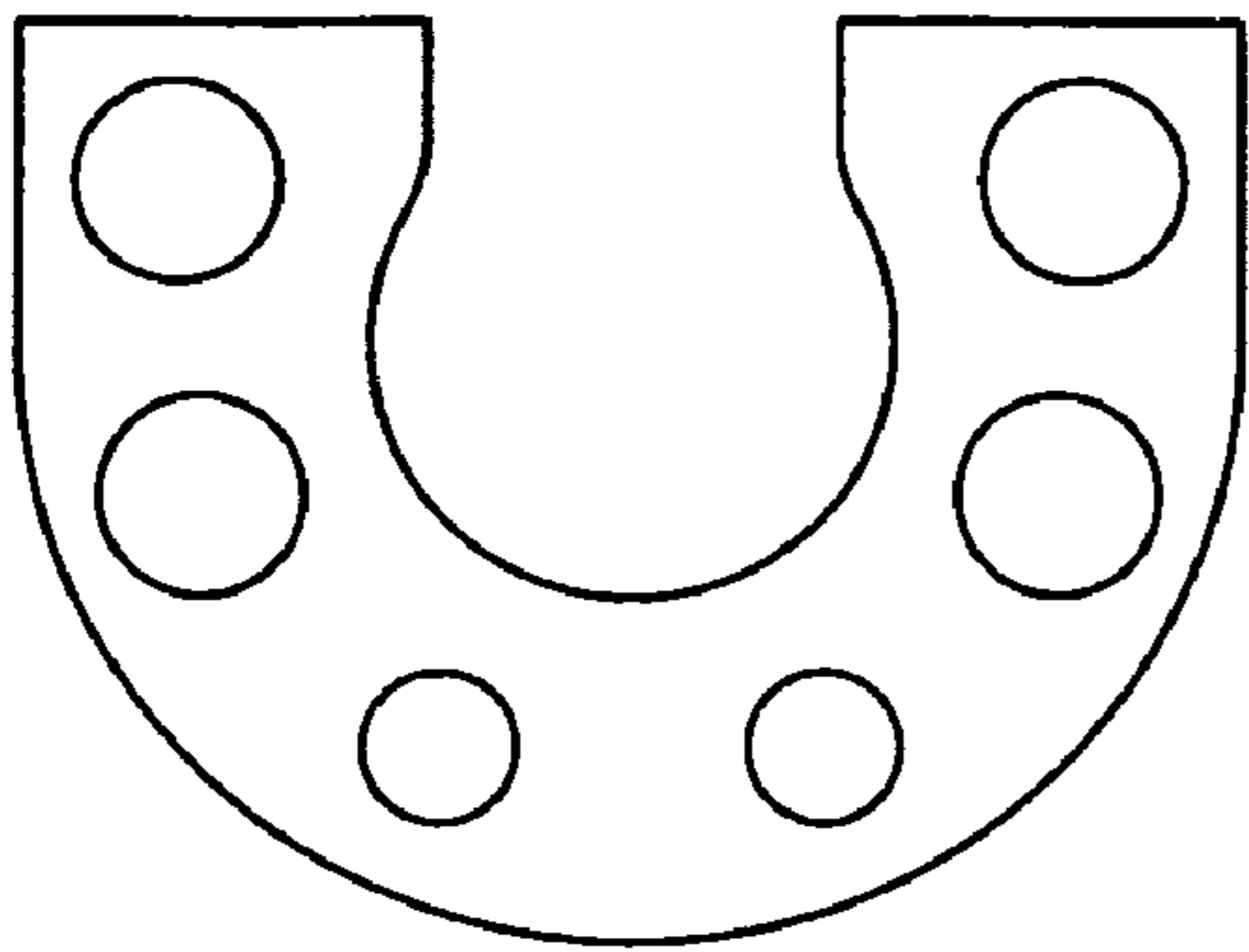

FIG. 7

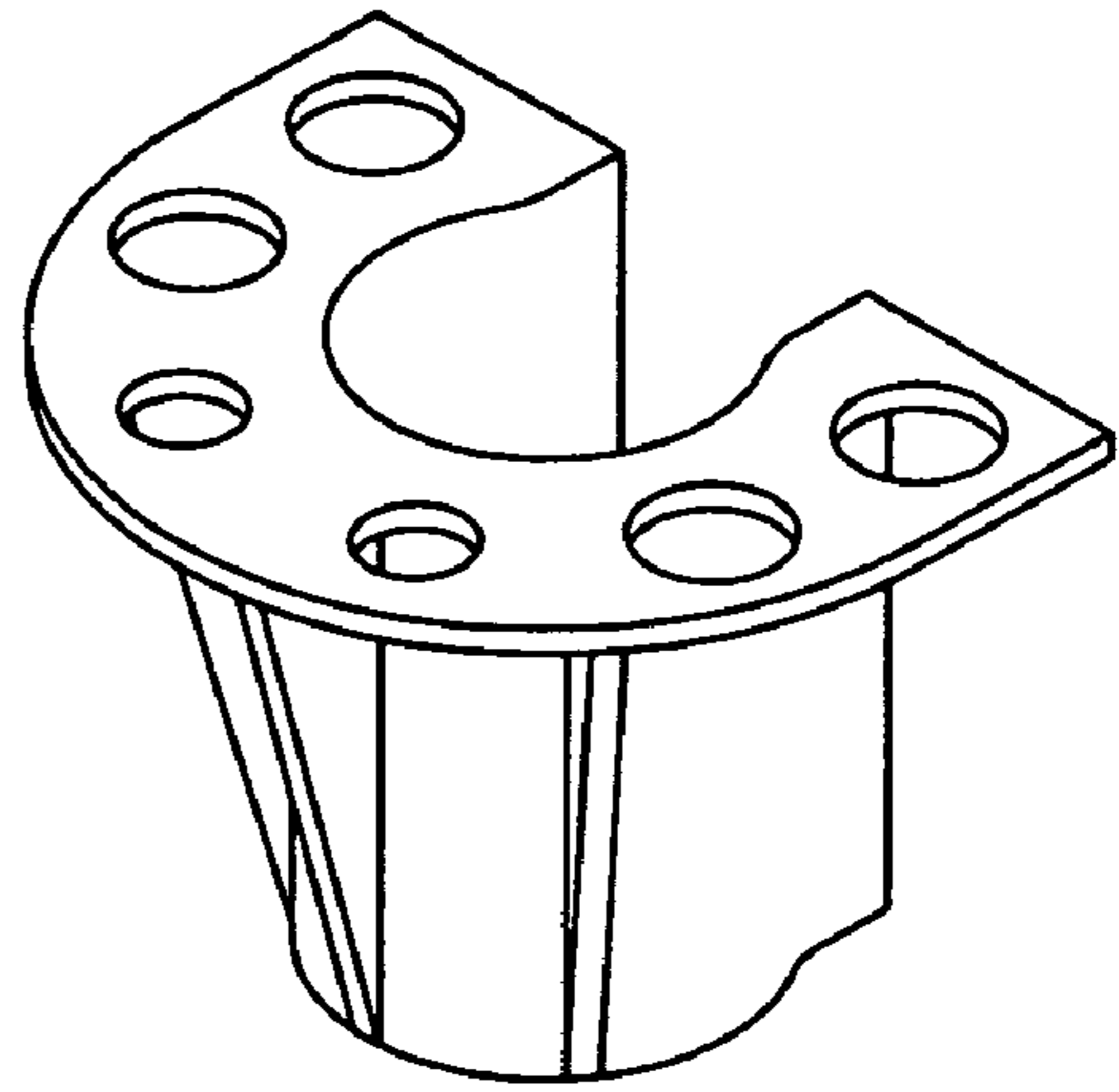

FIG. 8

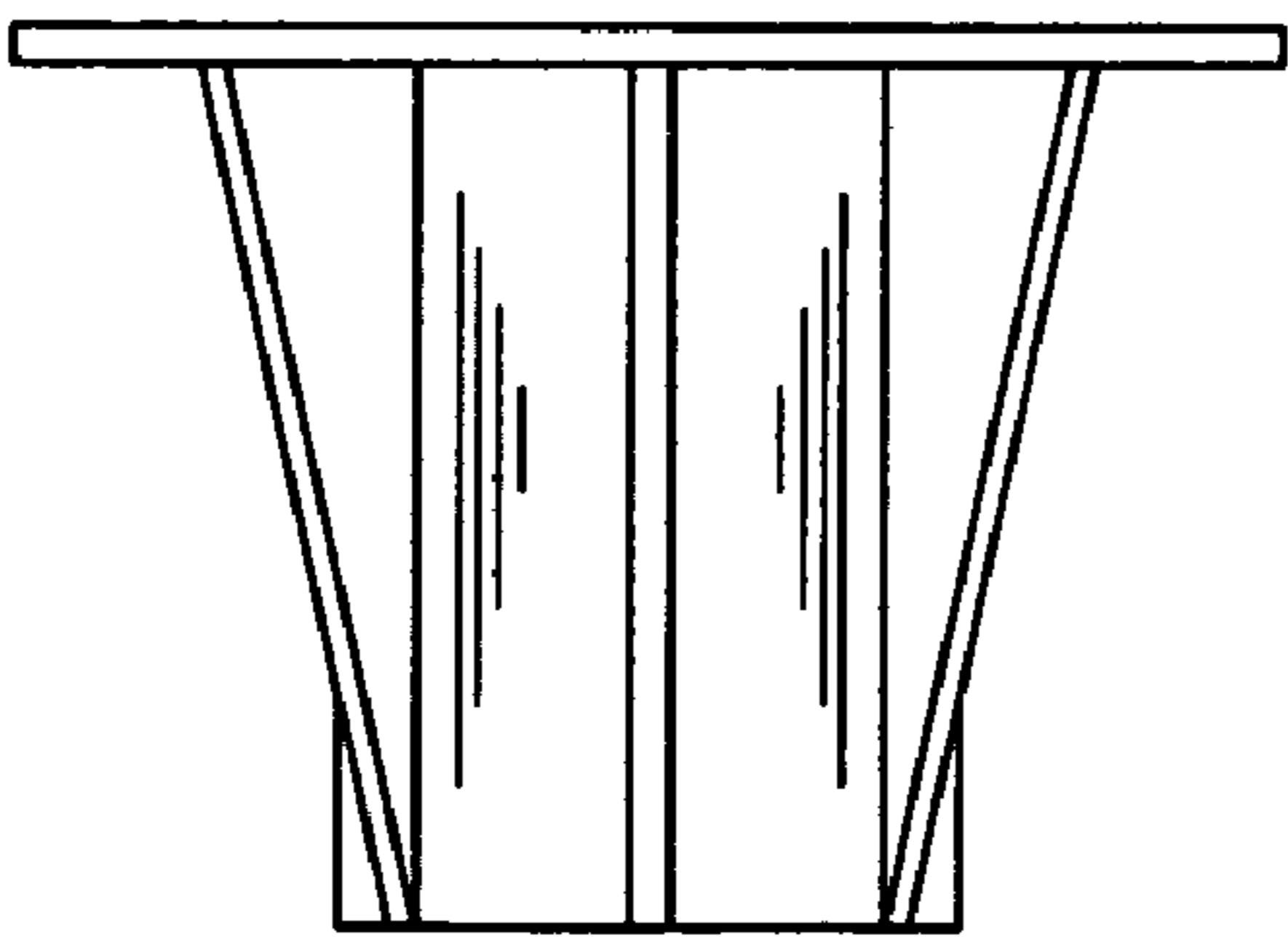

FIG. 5

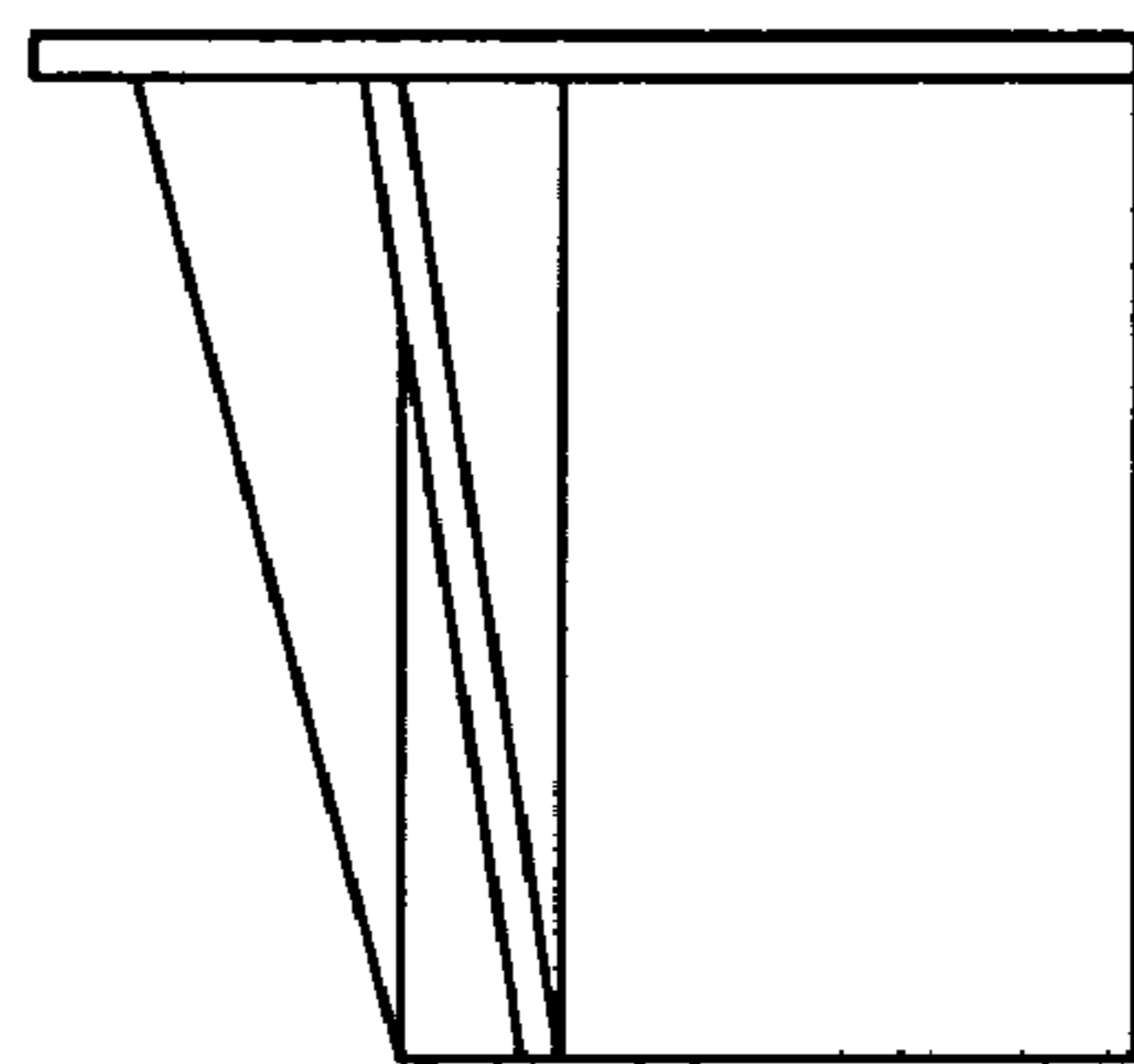

FIG. 6