



US00D566414S

(12) **United States Design Patent**
Gallahan

(10) **Patent No.:** **US D566,414 S**

(45) **Date of Patent:** **** Apr. 15, 2008**

(54) **PORTABLE WAXING CHAIR**

(76) Inventor: **Millie M. Gallahan**, 36933 Freds La.,
Purcellville, VA (US) 20132

(**) Term: **14 Years**

(21) Appl. No.: **29/287,293**

(22) Filed: **Jul. 19, 2007**

(51) **LOC (8) Cl.** **06-01**

(52) **U.S. Cl.** **D6/380; D6/379**

(58) **Field of Classification Search** D6/334-336,
D6/360, 370, 374-376, 379, 380, 500-502;
297/239, 396, 445.1, 446.1, 411.42

See application file for complete search history.

(56) **References Cited**

U.S. PATENT DOCUMENTS

| | | | | |
|--------------|---------|------------------|-------|--------|
| D308,143 S * | 5/1990 | Lohmeyer | | D6/379 |
| D344,196 S * | 2/1994 | Snodgrass et al. | | D6/380 |
| D355,308 S * | 2/1995 | Marini | | D6/379 |
| D360,539 S * | 7/1995 | Cretcher | | D6/379 |
| D361,675 S * | 8/1995 | Ruy | | D6/379 |
| D401,455 S | 11/1998 | Pate | | |
| D409,409 S * | 5/1999 | Muller | | D6/380 |

| | | | | |
|--------------|---------|---------------|-------|--------|
| D420,821 S * | 2/2000 | Barile et al. | | D6/360 |
| D431,385 S * | 10/2000 | Barile et al. | | D6/370 |
| D431,725 S * | 10/2000 | Barile et al. | | D6/370 |
| D482,887 S * | 12/2003 | Chen | | D6/380 |

* cited by examiner

Primary Examiner—Mimosa De

(74) *Attorney, Agent, or Firm*—Richard C. Litman

(57) **CLAIM**

The ornamental design for a portable waxing chair, as shown and described.

DESCRIPTION

FIG. 1 is a perspective view of a portable waxing chair showing my new design;

FIG. 2 is a front elevational view thereof;

FIG. 3 is a rear elevational view thereof;

FIG. 4 is a right side elevational view with the left side being a mirror image thereof;

FIG. 5 is a top view thereof; and,

FIG. 6 is a bottom view thereof.

1 Claim, 6 Drawing Sheets

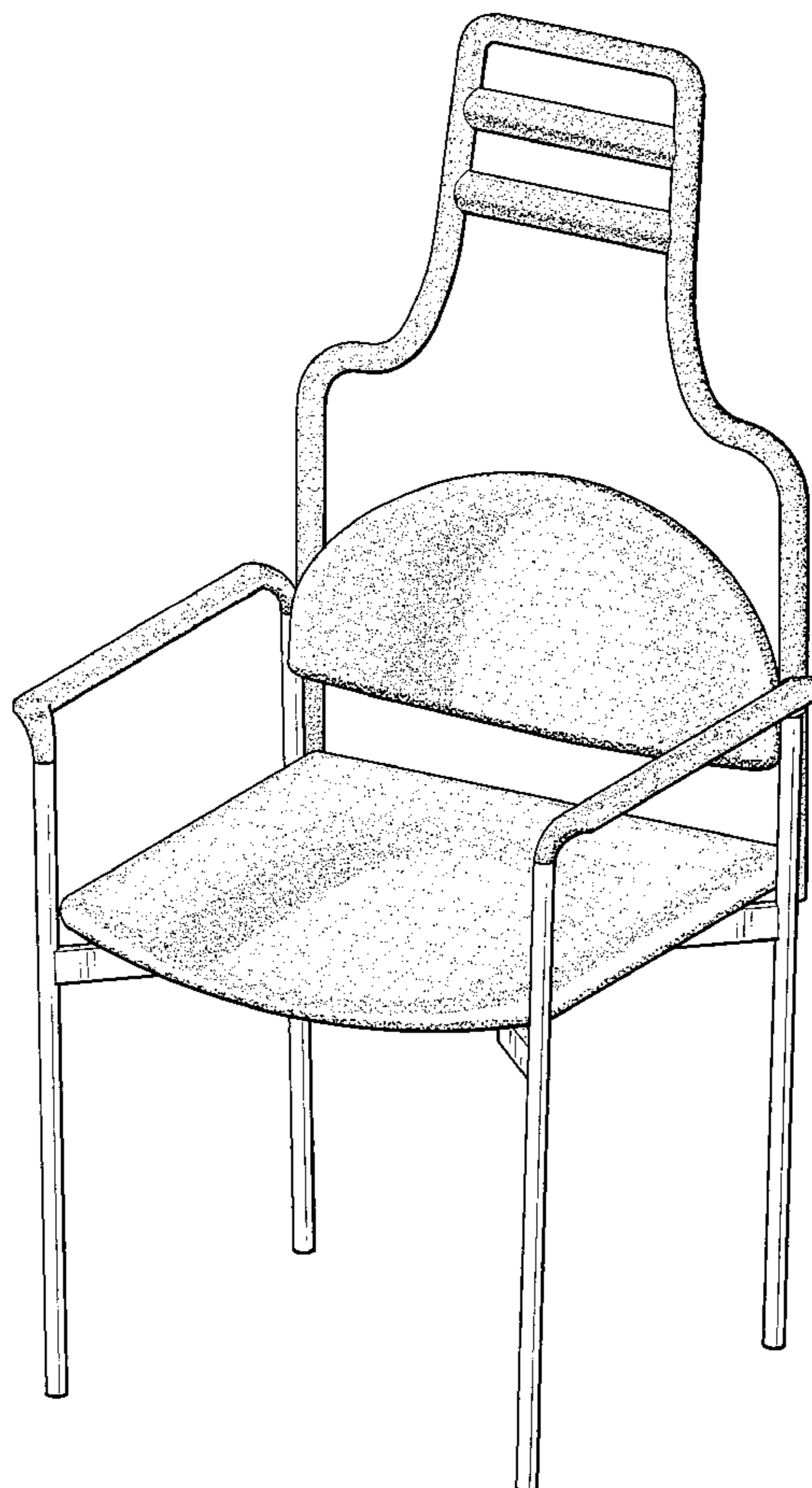

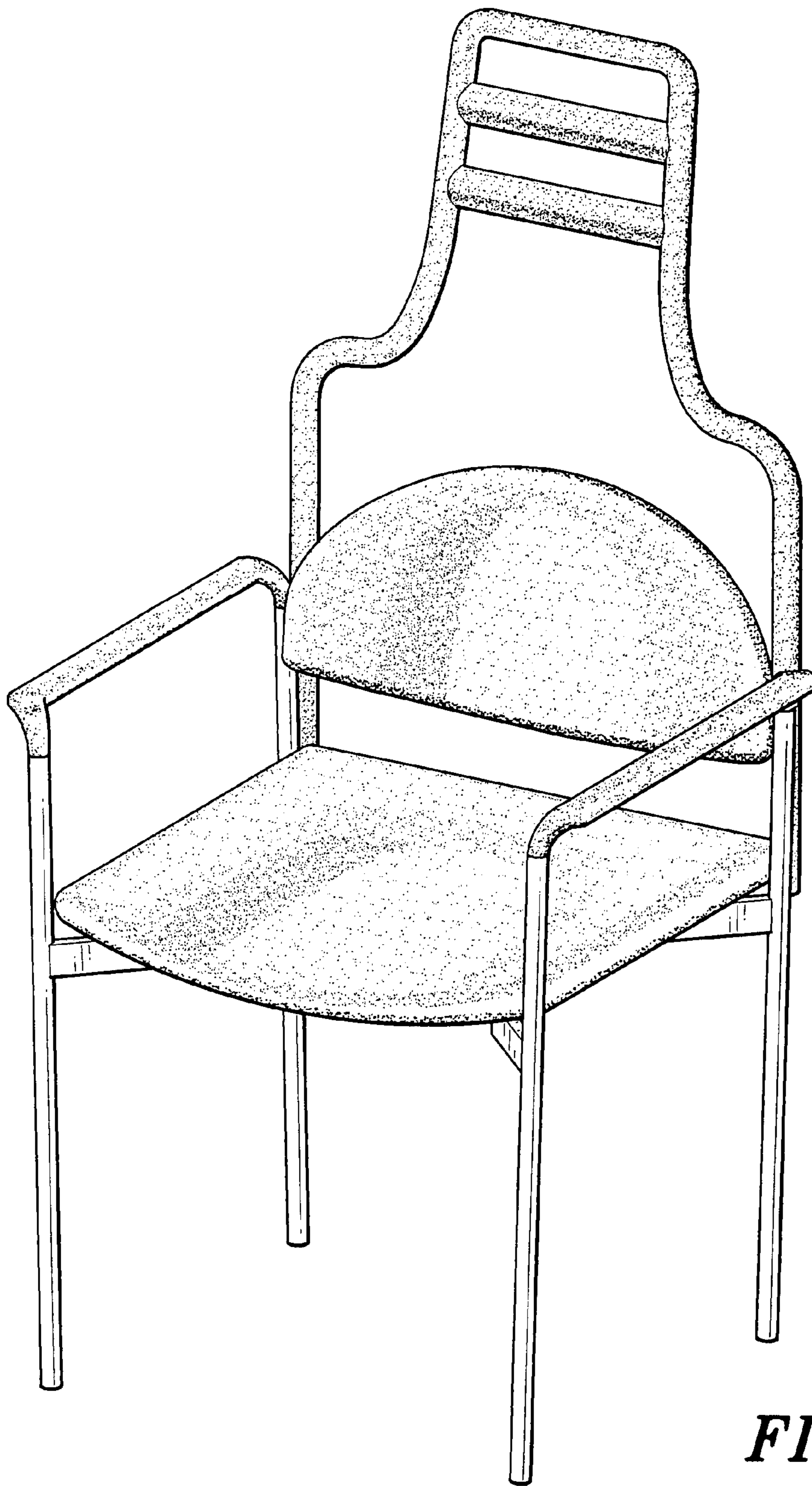

FIG. 1

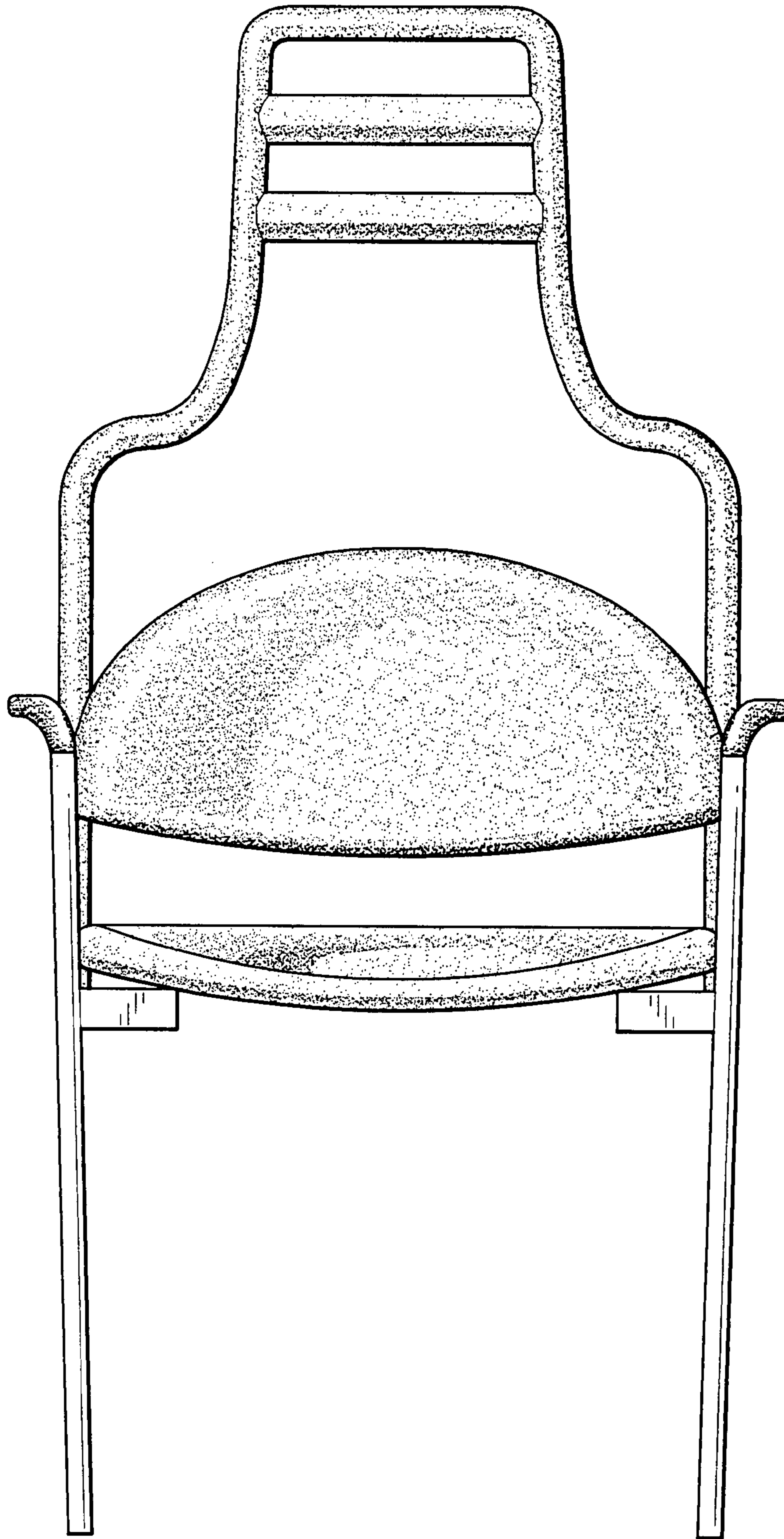

FIG. 2

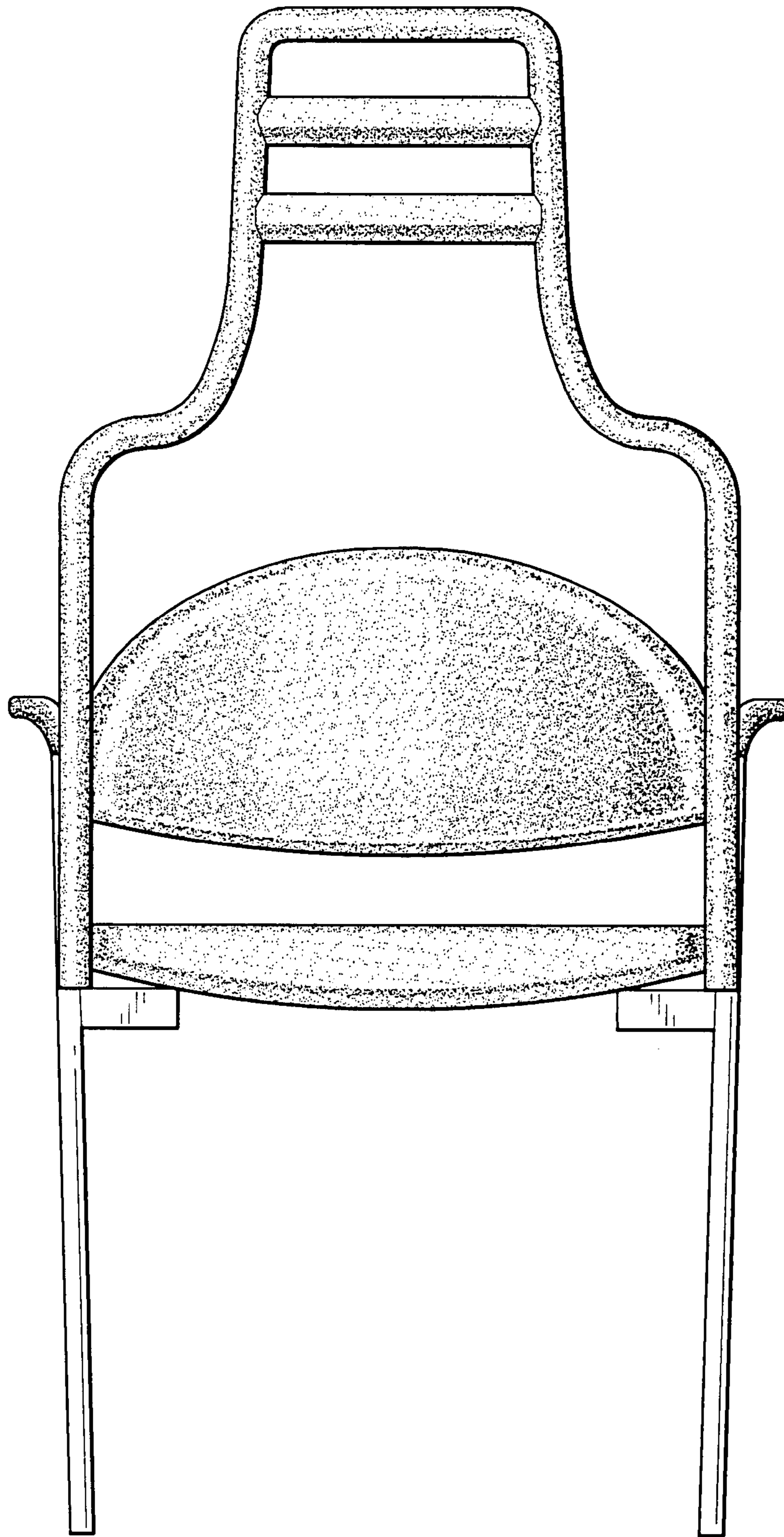

FIG. 3

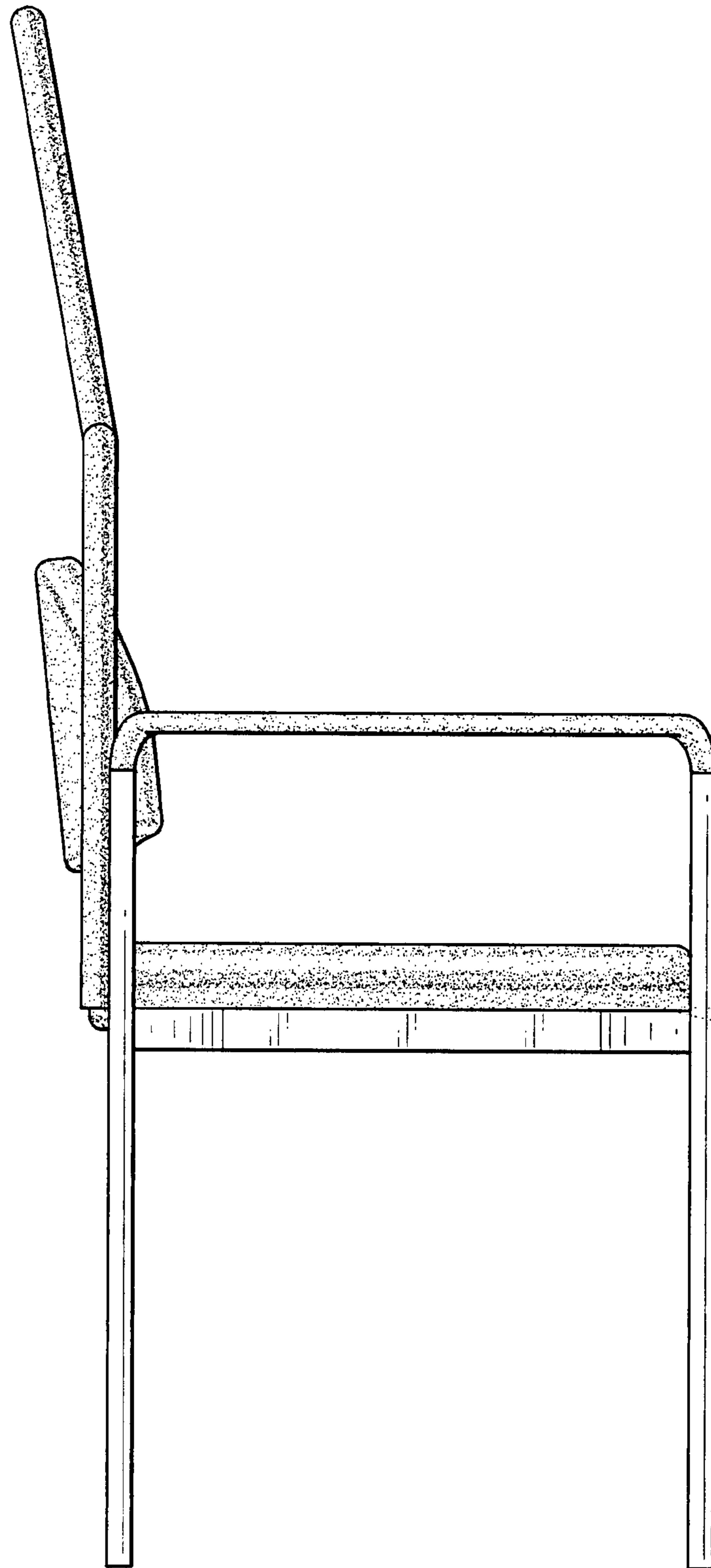

FIG. 4

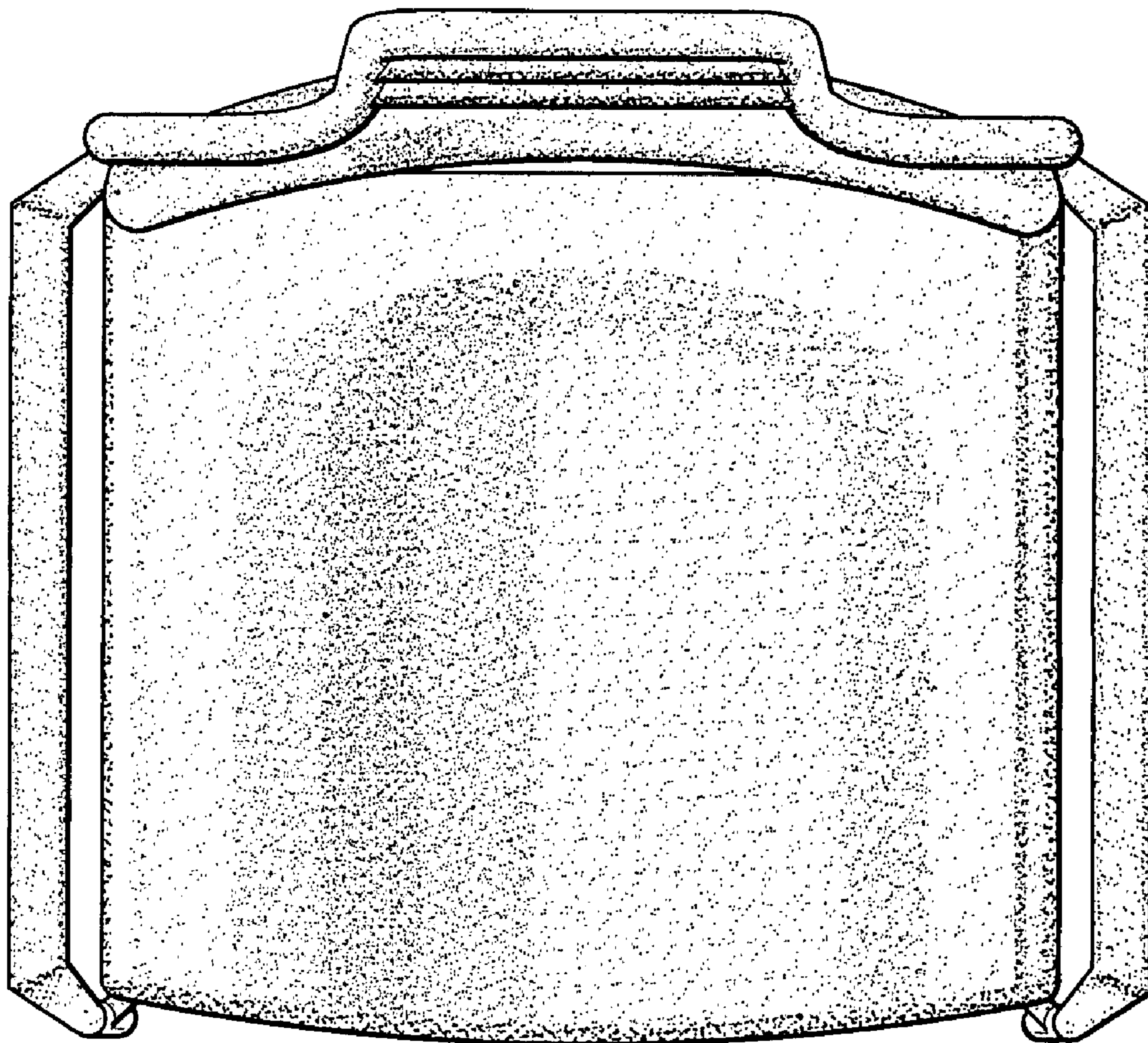

FIG. 5

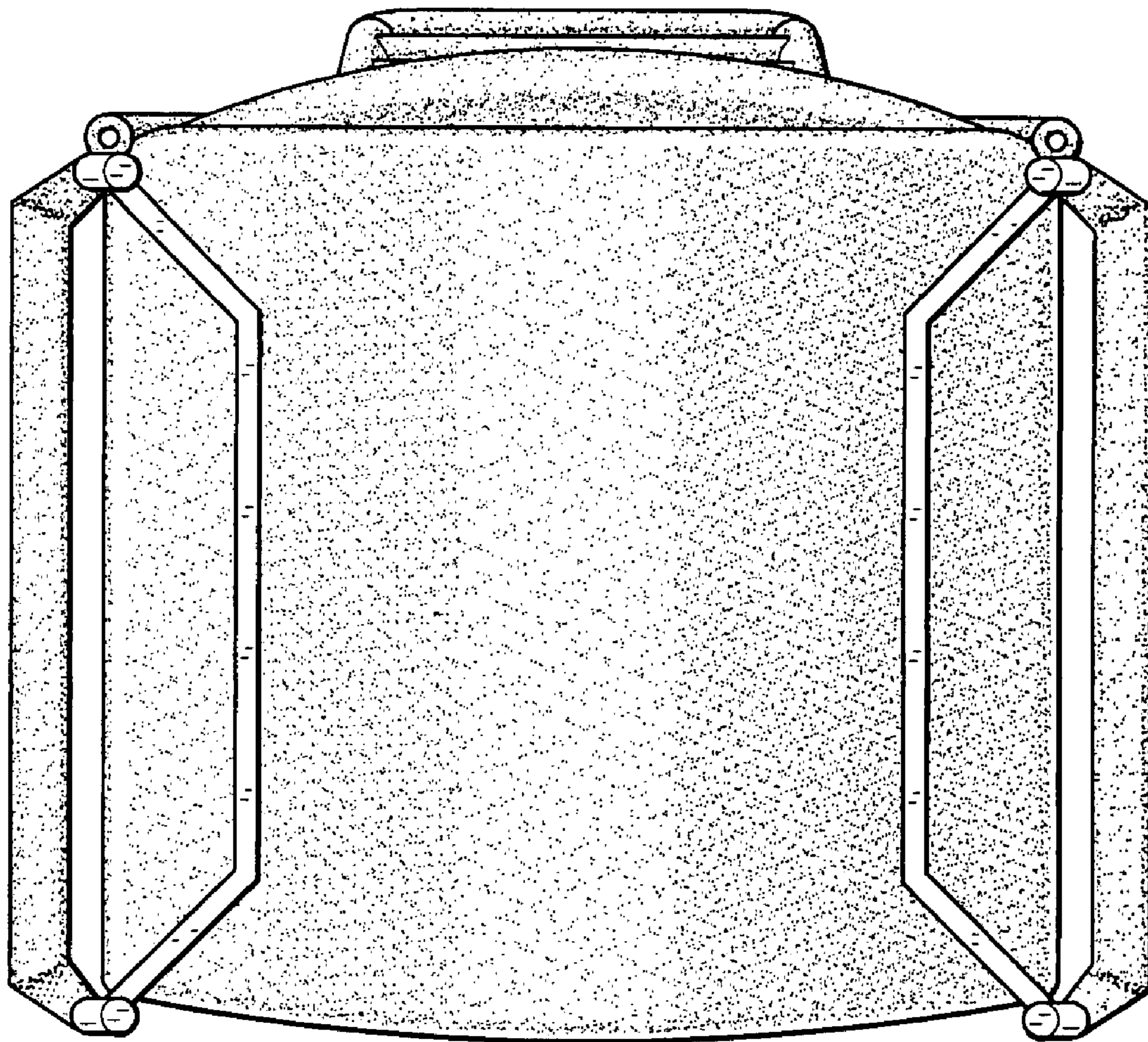

FIG. 6