



US00D566164S

(12) **United States Design Patent**
Sato et al.

(10) **Patent No.:** **US D566,164 S**
(45) **Date of Patent:** **** Apr. 8, 2008**

(54) **ELECTRONIC PIANO**

2006/0229165 A1* 10/2006 Michelson et al. 482/44

(75) Inventors: **Daizo Sato**, Hamamatsu (JP); **Takashi Honda**, Aichi-gun (JP)

FOREIGN PATENT DOCUMENTS

(73) Assignee: **Yamaha Corporation**, Shizuoka (JP)

EP 1005014 A2 * 5/2000
JP 2001296868 A * 10/2001
JP 2007025444 A * 2/2007

(**) Term: **14 Years**

* cited by examiner

(21) Appl. No.: **29/274,196**

Primary Examiner—Ian Simmons

(22) Filed: **Apr. 4, 2007**

Assistant Examiner—R. Johnson

(74) *Attorney, Agent, or Firm*—Sughrue Mion, PLLC

(30) **Foreign Application Priority Data**

(57) **CLAIM**

Dec. 28, 2006 (JP) 2006-036231

The ornamental design for an electronic piano, as shown and described.

(51) **LOC (8) Cl.** **17-01**

DESCRIPTION

(52) **U.S. Cl.** **D17/1**

(58) **Field of Classification Search** D17/1,
D17/2, 7, 8, 9; 84/13, 15, 17, 26, 72, 172,
84/174, 178, 184, 192, 225, 239, 240, 243,
84/423 R, 426, 429, 743–746; D21/409
See application file for complete search history.

FIG. 1 is a perspective view of the top, front, and left side of an electronic piano showing our new design;

FIG. 2 is a top plan view thereof;

FIG. 3 is a front elevational view thereof;

FIG. 4 is a right side elevational view thereof;

FIG. 5 is a left side elevational view thereof;

FIG. 6 is a rear elevational view thereof; and,

FIG. 7 is a bottom plan view thereof.

The portions shown in broken lines are for illustrative purposes only and form no part of the claimed design.

(56) **References Cited**

U.S. PATENT DOCUMENTS

1,719,016 A * 7/1929 MacDow 84/180
3,149,528 A * 9/1964 Von Gunten 84/425
4,593,593 A * 6/1986 Bellini 84/177
D313,034 S * 12/1990 Koide D17/1
5,492,291 A * 2/1996 Otani 248/118.1
D510,381 S * 10/2005 Okamura et al. D17/1

1 Claim, 4 Drawing Sheets

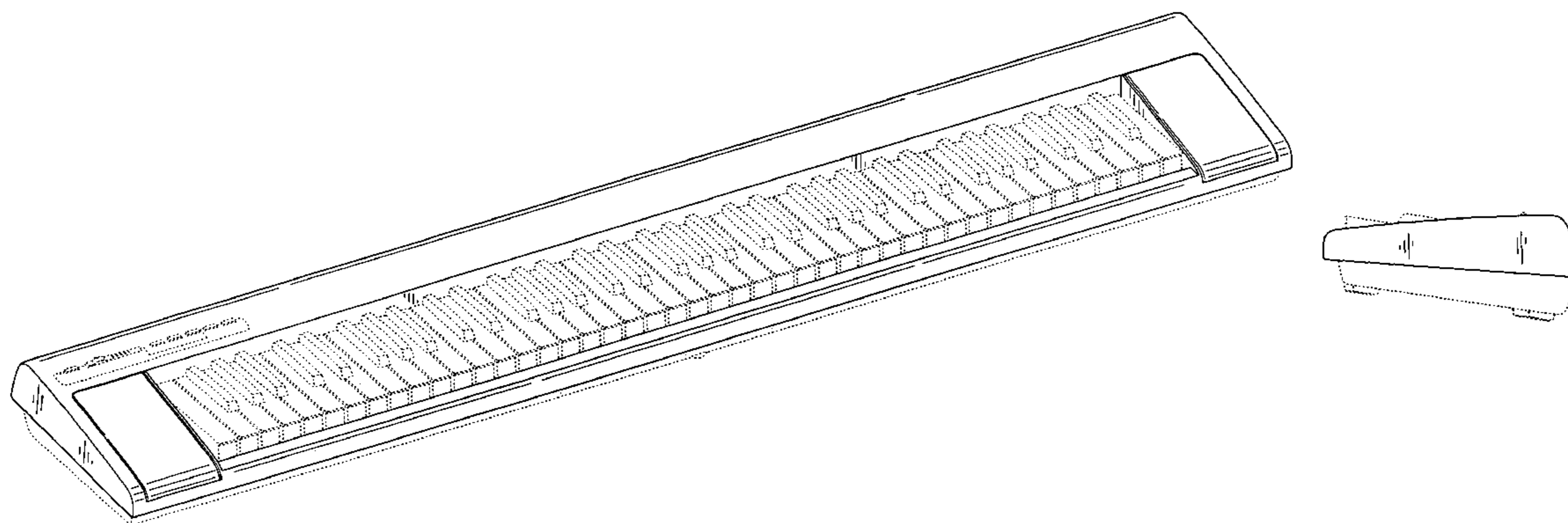

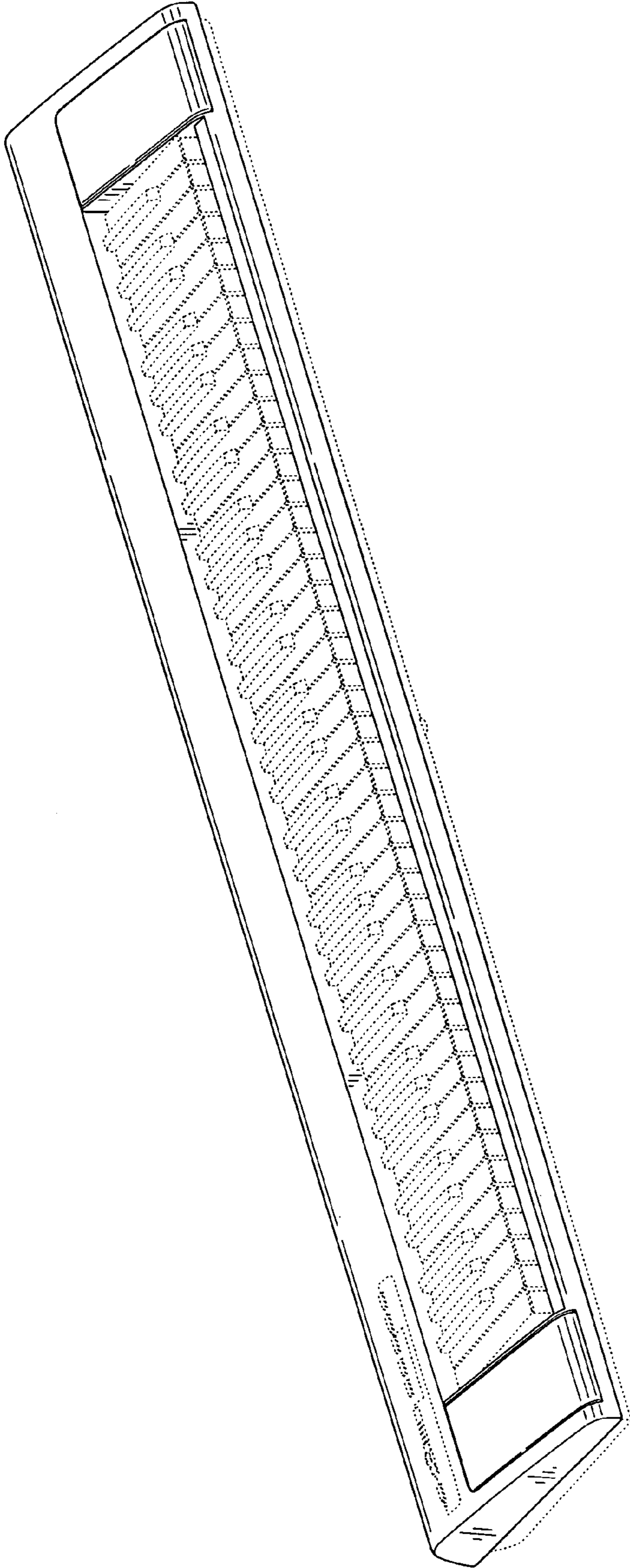

FIG. 1

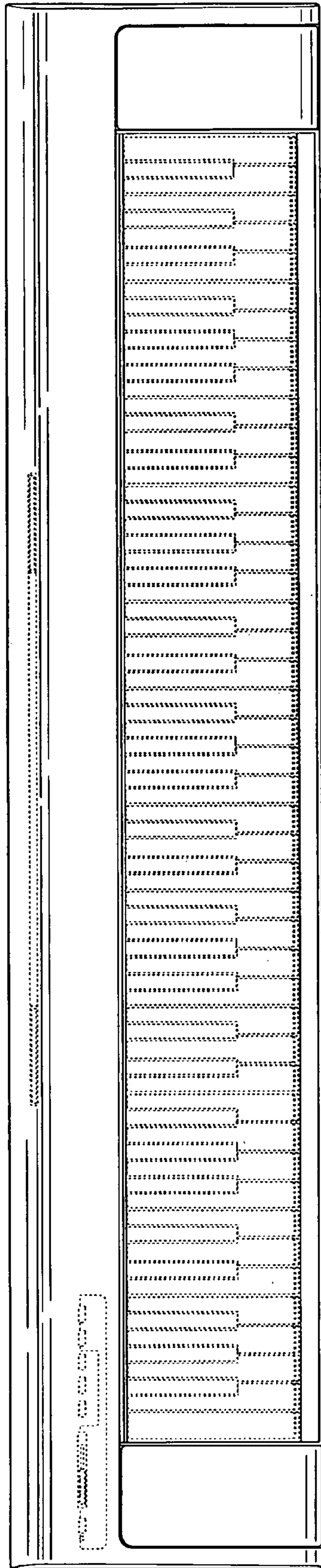

FIG. 2

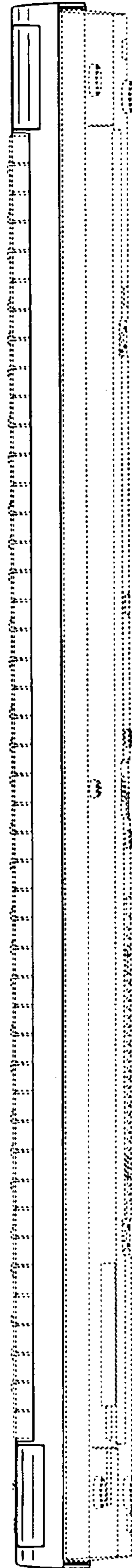

FIG. 3

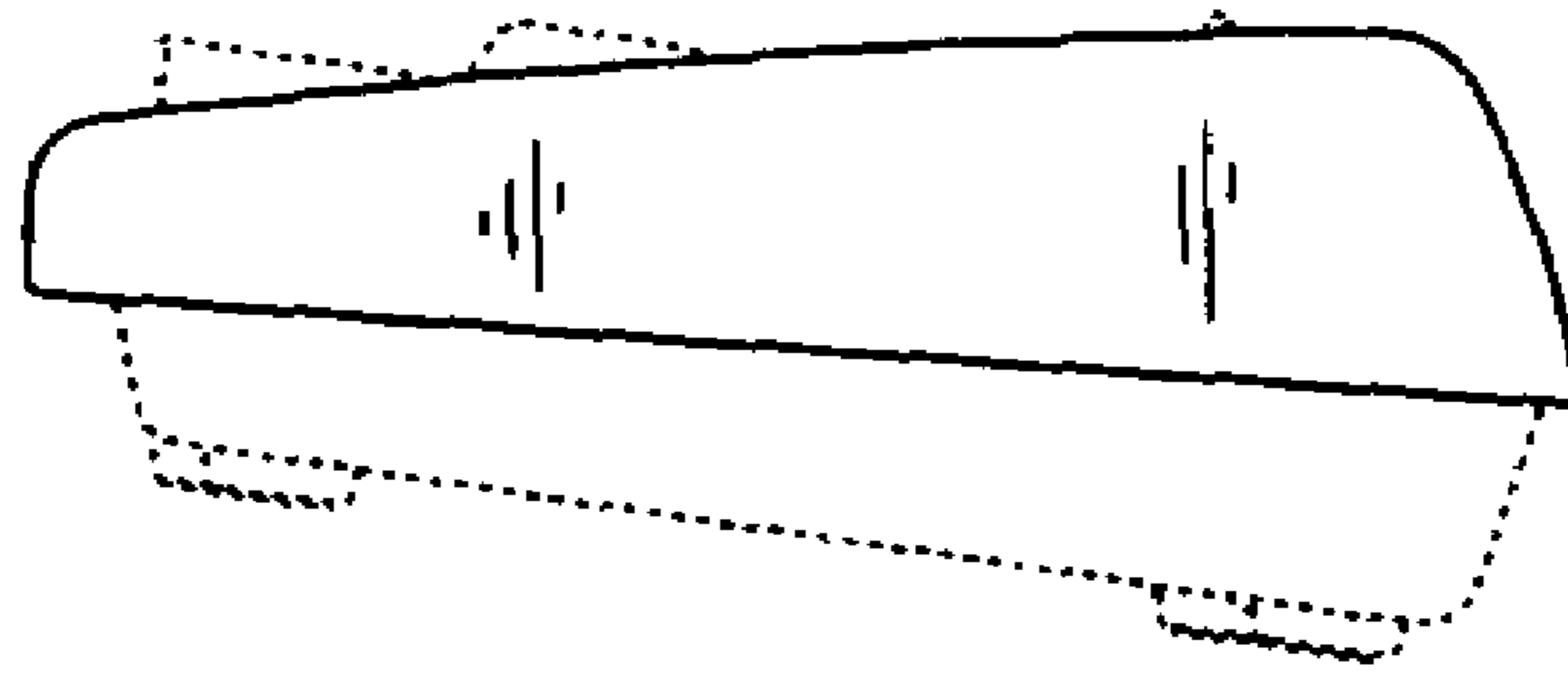

FIG. 4

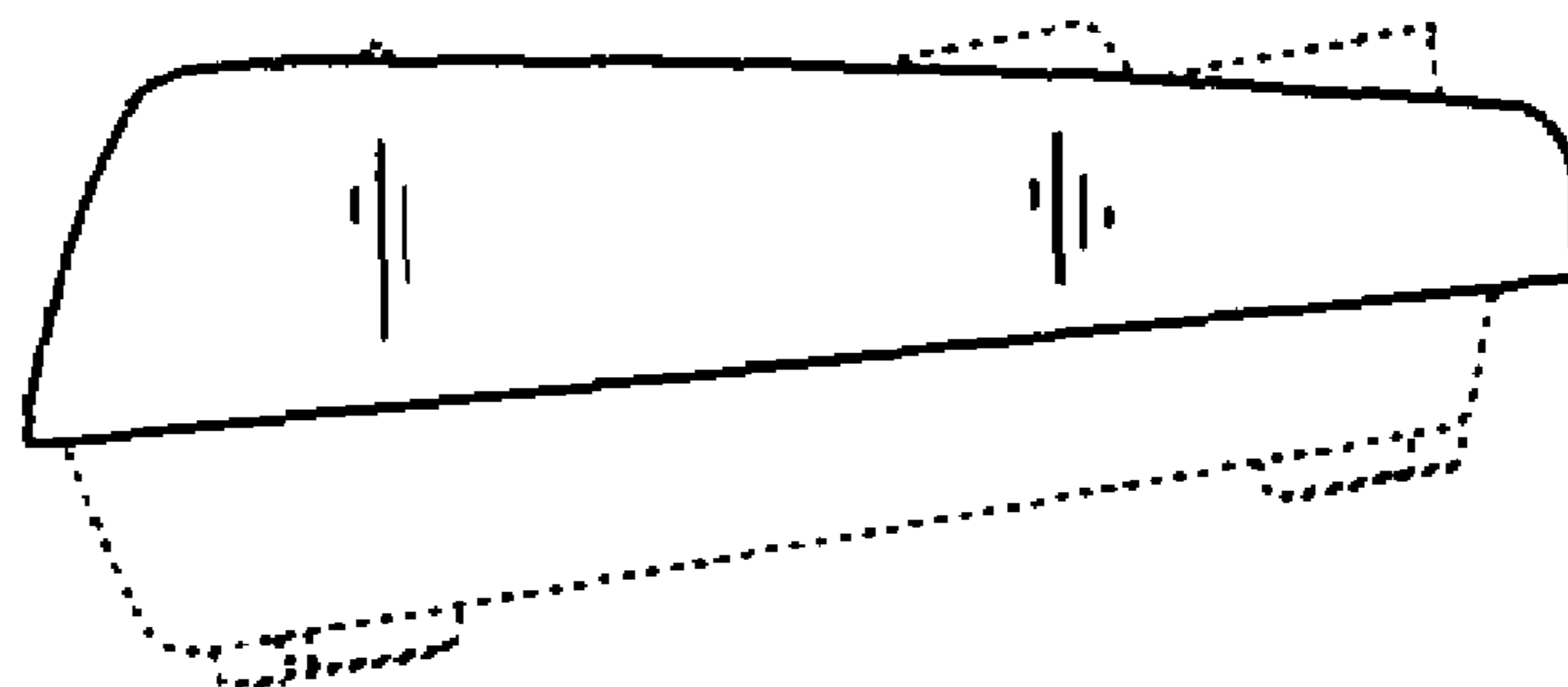

FIG. 5

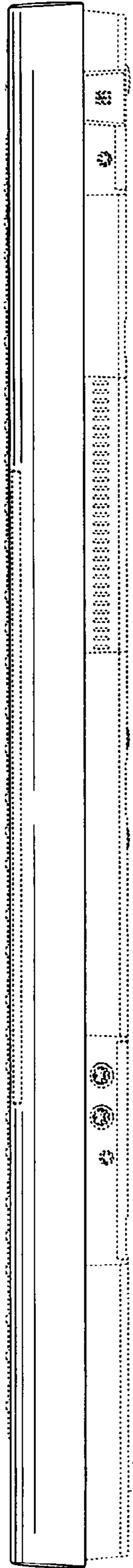

FIG. 6

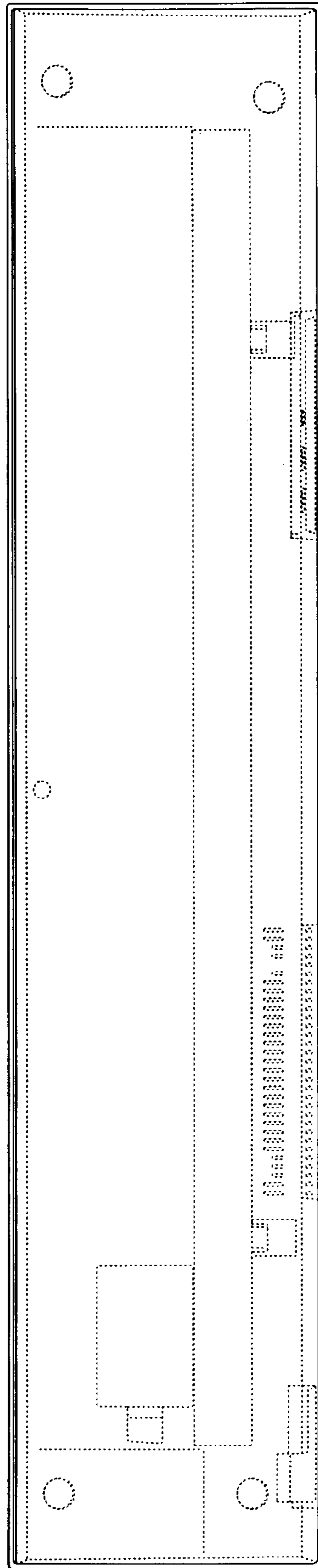

FIG. 7