



(12) **United States Design Patent** (10) **Patent No.:** **US D566,051 S**  
**Govindasamy** (45) **Date of Patent:** **\*\* Apr. 8, 2008**

(54) **CONTROL MODULE**

(75) Inventor: **Gururaj Govindasamy**, Glenview, IL (US)

(73) Assignee: **Shure Acquisition Holdings, Inc.**, Niles, IL (US)

(\*\*) Term: **14 Years**

(21) Appl. No.: **29/275,520**

(22) Filed: **Dec. 28, 2006**

(51) **LOC (8) Cl.** ..... **13-03**

(52) **U.S. Cl.** ..... **D13/168; D14/218**

(58) **Field of Classification Search** ..... D13/158, D13/162, 168, 171; D14/218, 223, 240; D10/104, 106; D3/207, 208, 218; 455/151.1–151.4, 455/152.1, 352–355

See application file for complete search history.

(56) **References Cited**

**U.S. PATENT DOCUMENTS**

D451,077 S	*	11/2001	Montagnino et al. ....	D13/168
D451,483 S	*	12/2001	Montagnino et al. ....	D13/168
D456,366 S	*	4/2002	Montagnino et al. ....	D13/168
D462,945 S	*	9/2002	Skulley .....	D14/218
D463,787 S	*	10/2002	Beraut et al. ....	D14/218
D465,477 S	*	11/2002	Beraut et al. ....	D14/218
D473,545 S	*	4/2003	Rivera .....	D14/223
D481,364 S	*	10/2003	Kosumsuppamala et al. ...	D13/168
D511,145 S	*	11/2005	Donofrio et al. ....	D13/168
D520,464 S	*	5/2006	Strong et al. ....	D13/171
D538,789 S	*	3/2007	Naruki et al. ....	D14/218

**OTHER PUBLICATIONS**

Printout of web pages regarding Seidioonline: 2-in-1 Adaptors (Standard or H2RSOVTR650-BK Retractable (retrieved Dec. 14, 2006) <URL:http://www.seidioonline.com/index.asp?PageAction=VIEWPROD&ProdID=230>.

Printout of web pages regarding Sony Ericsson Stereo Portable Handsfree HPM-70 (retrieved Dec. 14, 2006) <URL:http://www.

sonyericsson.com/spg.jsp?ec=us&lo=en&ver=4000 &template=pip1&zzone=pp&pid=10254>.  
 Printout of web page regarding Verizon Wireless: Stereo Adapter 2.5 mm to 3.5 mm with Call Answer/End Button (retrieved Dec. 14, 2006) <URL:http://www.verizonwireless.com/b2c/store/accessoryPopup?item=accessoryMart&accessoryId=21326>.  
 Printout of web page regarding Verizon Wireless: Stereo Headset with Call Answer/End Button (retrieved Dec. 14, 2006) <URL:http://www.verizonwireless.com/b2c/store/accessoryPopup?item=accessoryMart&accessoryId=21141>.  
 Printout of web pages regarding Bose: QuietComfort 2 Acoustic Noise Cancelling Headphones—Headphones and Headsets : QC 2 Cell Connect accessory kit (retrieved Dec. 14, 2006) <URL:http://www.bose.com/controller?event=VIEW\_PRODUCT\_PAGE\_EVENT &product=qc2\_headphones\_accessories#tabs>.  
 Printout of web pages regarding audio-technica: ATH-O66T (retrieved Dec. 14, 2006) <URL:http://www.audio-technica.co.jp/products/telacc/ath-q66t.html>.

(Continued)

*Primary Examiner*—Selina Sikder

*Assistant Examiner*—Thomas J Johannes

(74) *Attorney, Agent, or Firm*—Banner & Witcoff, Ltd.

(57) **CLAIM**

The ornamental design for a control module, as shown and described.

**DESCRIPTION**

FIG. 1 is a front right isometric view of a control module that shows my claimed design;

FIG. 2 is a rear right isometric view thereof;

FIG. 3 is a front view thereof;

FIG. 4 is a right side view thereof;

FIG. 5 is a rear view thereof;

FIG. 6 is a left side view thereof;

FIG. 7 is a top view thereof; and,

FIG. 8 is a bottom view thereof.

The broken lines in FIGS. 1 through 8 are for illustrative purposes only and form no part of the claimed design.

**1 Claim, 4 Drawing Sheets**

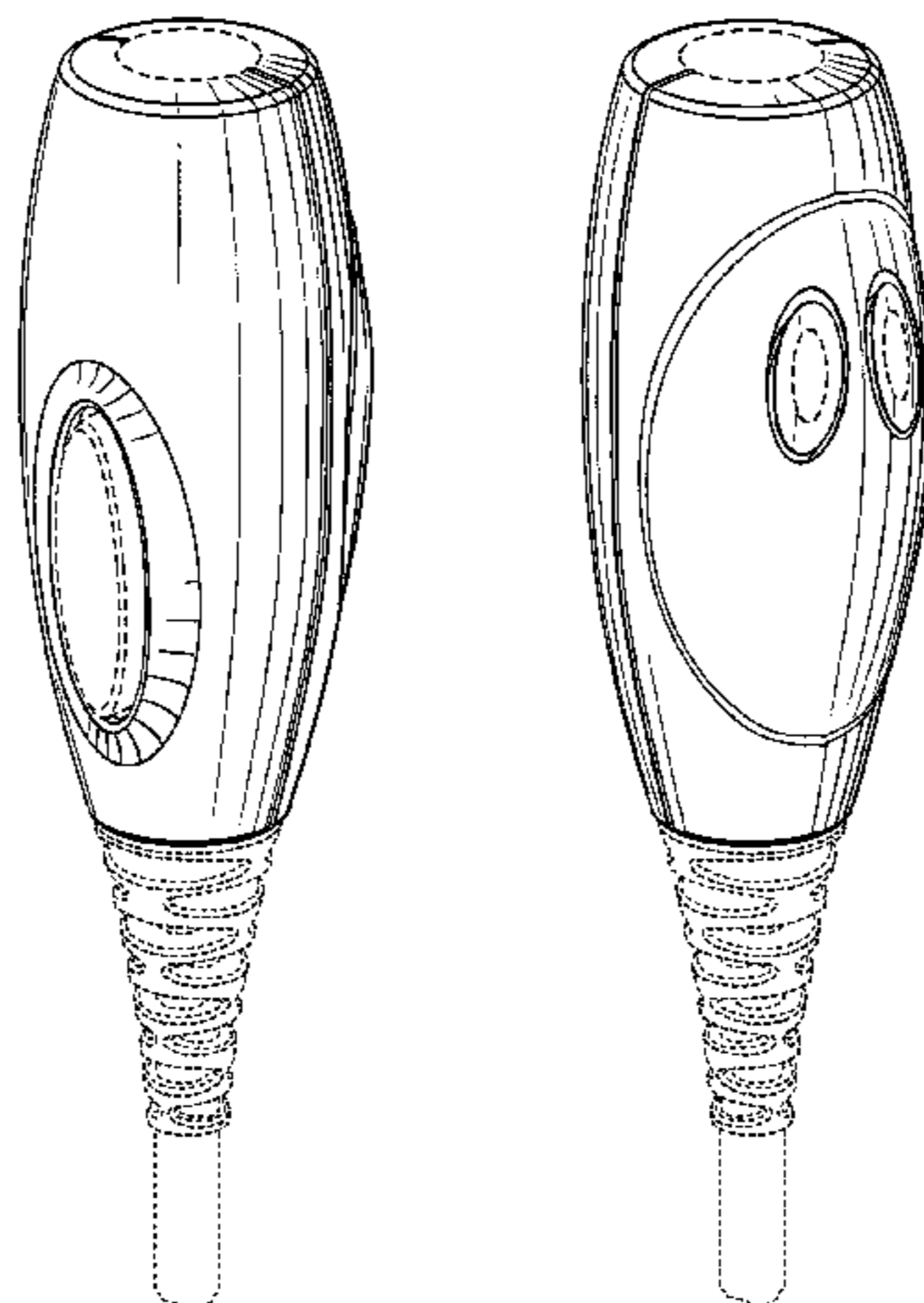

OTHER PUBLICATIONS

Printout of web pages regarding translated audio-technica: Product Information ATH-Q66T: Ear fitting headphone for portable telephone ATH-Q66T BK/WH (retrieved Dec. 14, 2006) <URL:[http://translate.google.com/translate?u=http%3A%2F%2Fwww.audio-technica.co.jp%2Fproducts%2Ftelacc%2Fath-q66t.html&langpair=ja%7Cen&hi=en&ie=UTF-8&oe=UTF-8&prev=%2Flanguage\\_tools](http://translate.google.com/translate?u=http%3A%2F%2Fwww.audio-technica.co.jp%2Fproducts%2Ftelacc%2Fath-q66t.html&langpair=ja%7Cen&hi=en&ie=UTF-8&oe=UTF-8&prev=%2Flanguage_tools)>.

Printout of web pages regarding Shure—Cases & Adapters: Attachable Volume Control : EA650 (formerly PA235) (retrieved Dec. 14, 2006) <URL:[http://www.shure.com/PersonalAudio/Products/Accessories/CasesAdapters/us\\_pa\\_pa235\\_level\\_attenuator](http://www.shure.com/PersonalAudio/Products/Accessories/CasesAdapters/us_pa_pa235_level_attenuator)>.

Print out of Plantronics MHS Stereo Mobile Headsets brochure 2006. MHS 113, MHS 123, MHS 213.

Print out of Shure Inc: PTH: Shure Personal Audio 2006 brochure.

\* cited by examiner

**Fig. 1**

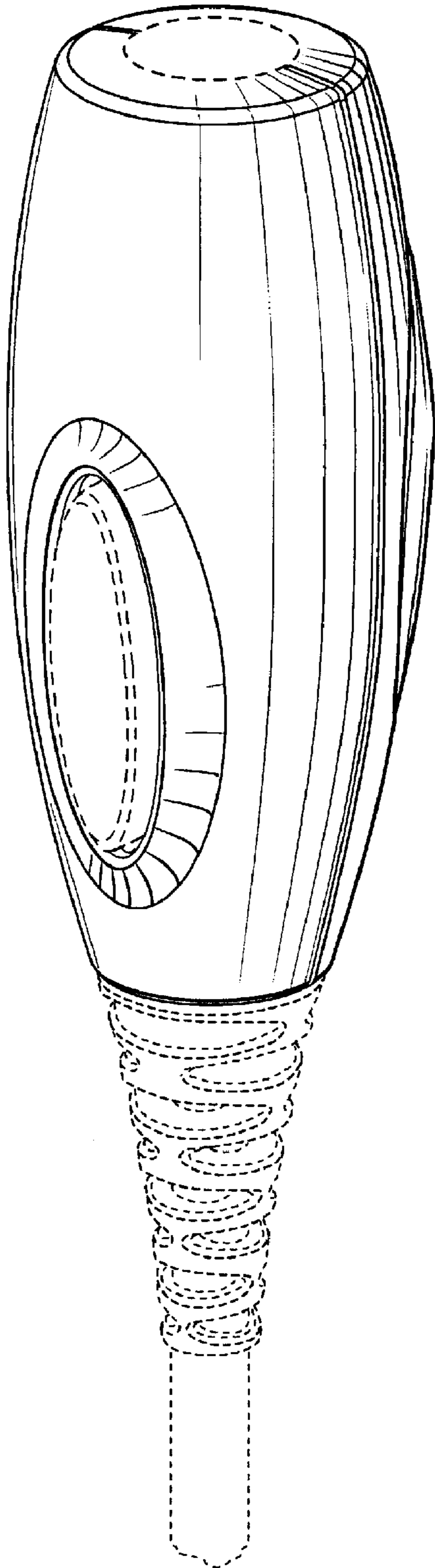

**Fig. 2**

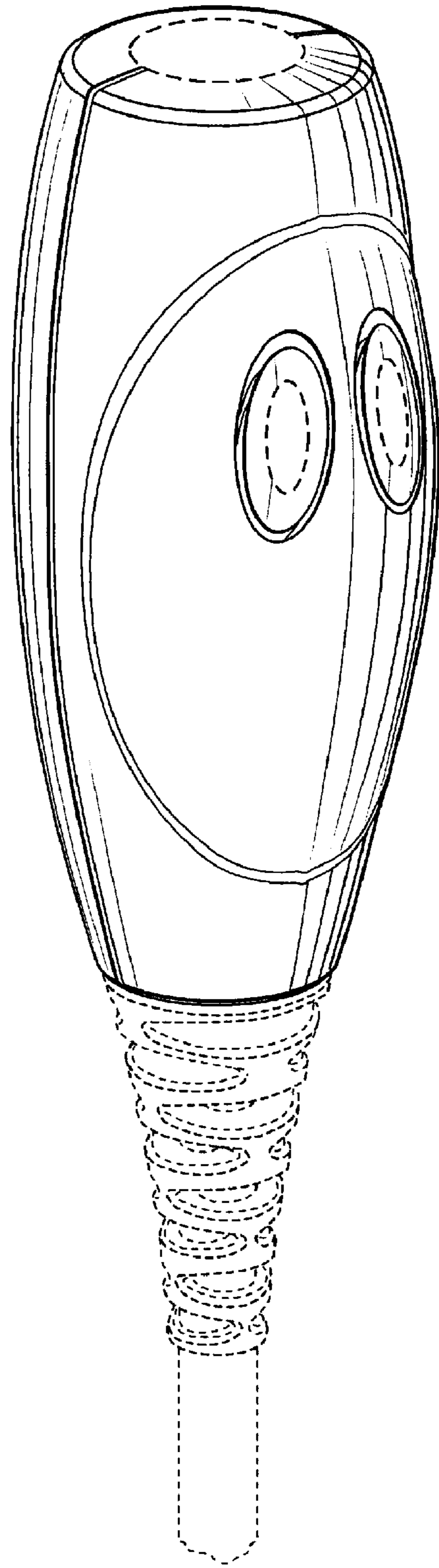

**Fig. 3**

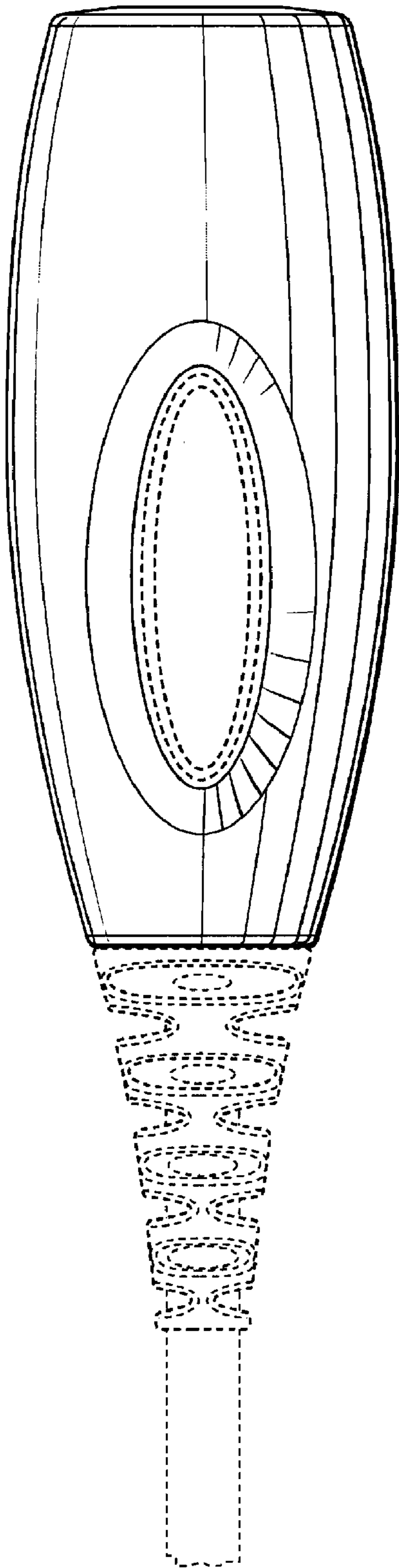

**Fig. 4**

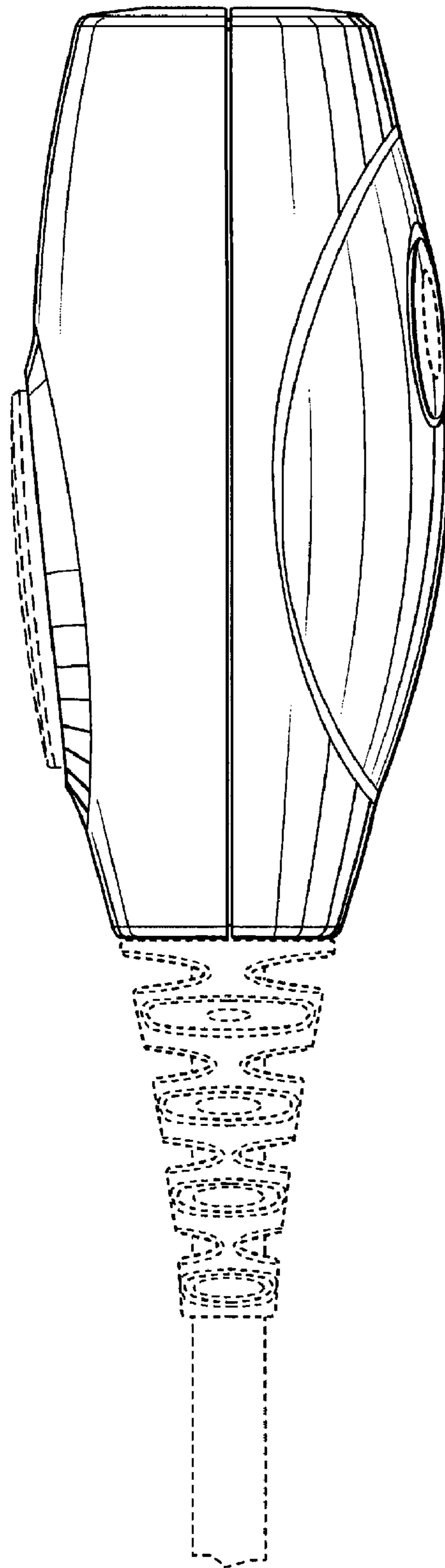

**Fig. 5**

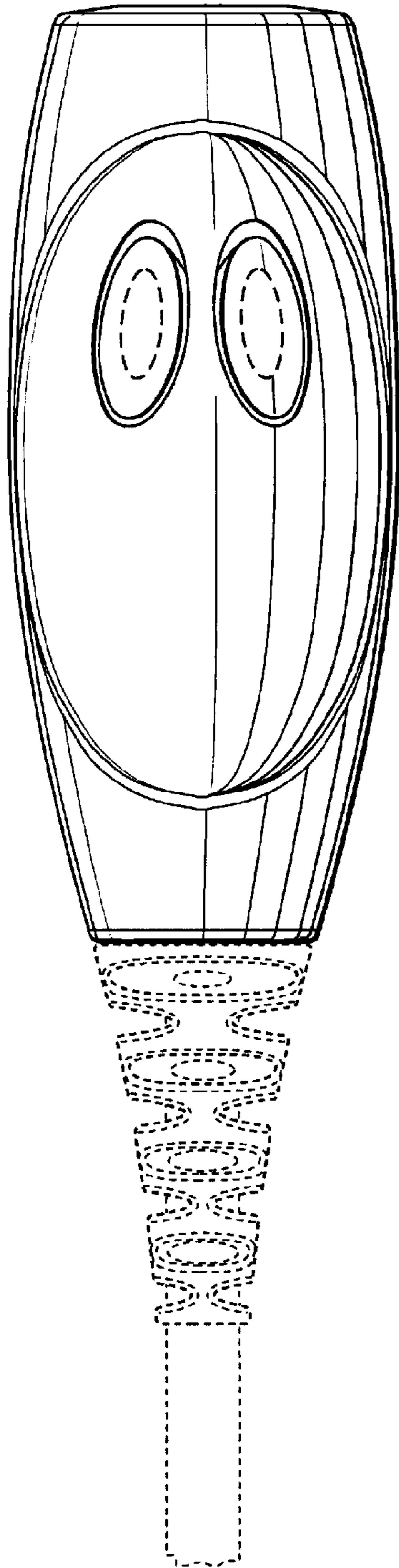

**Fig. 6**

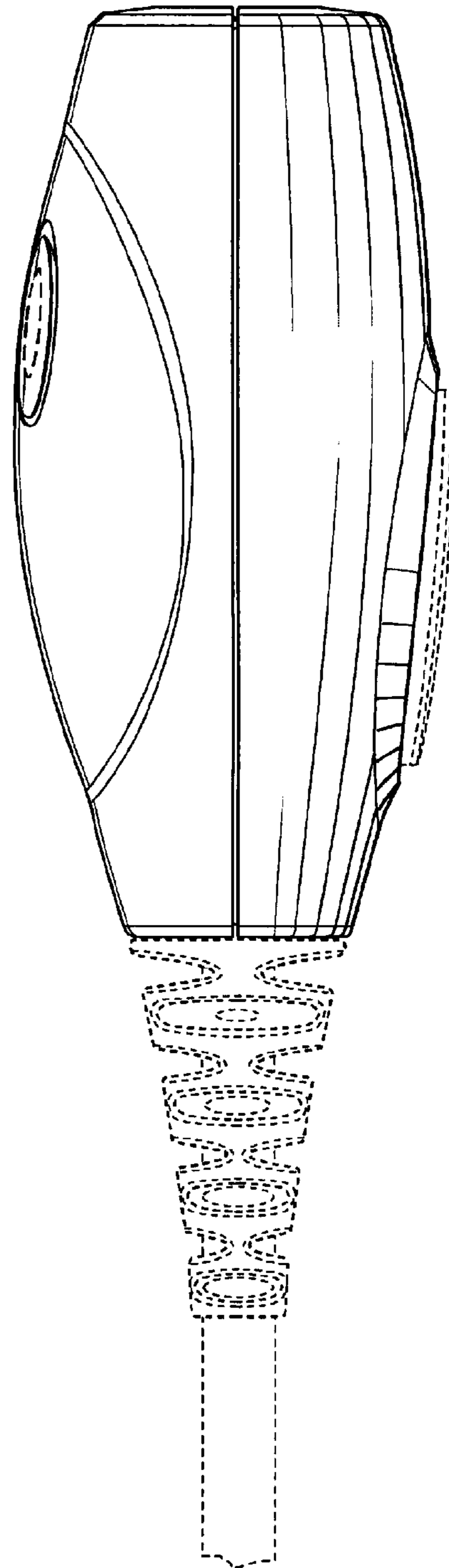

**Fig. 7**

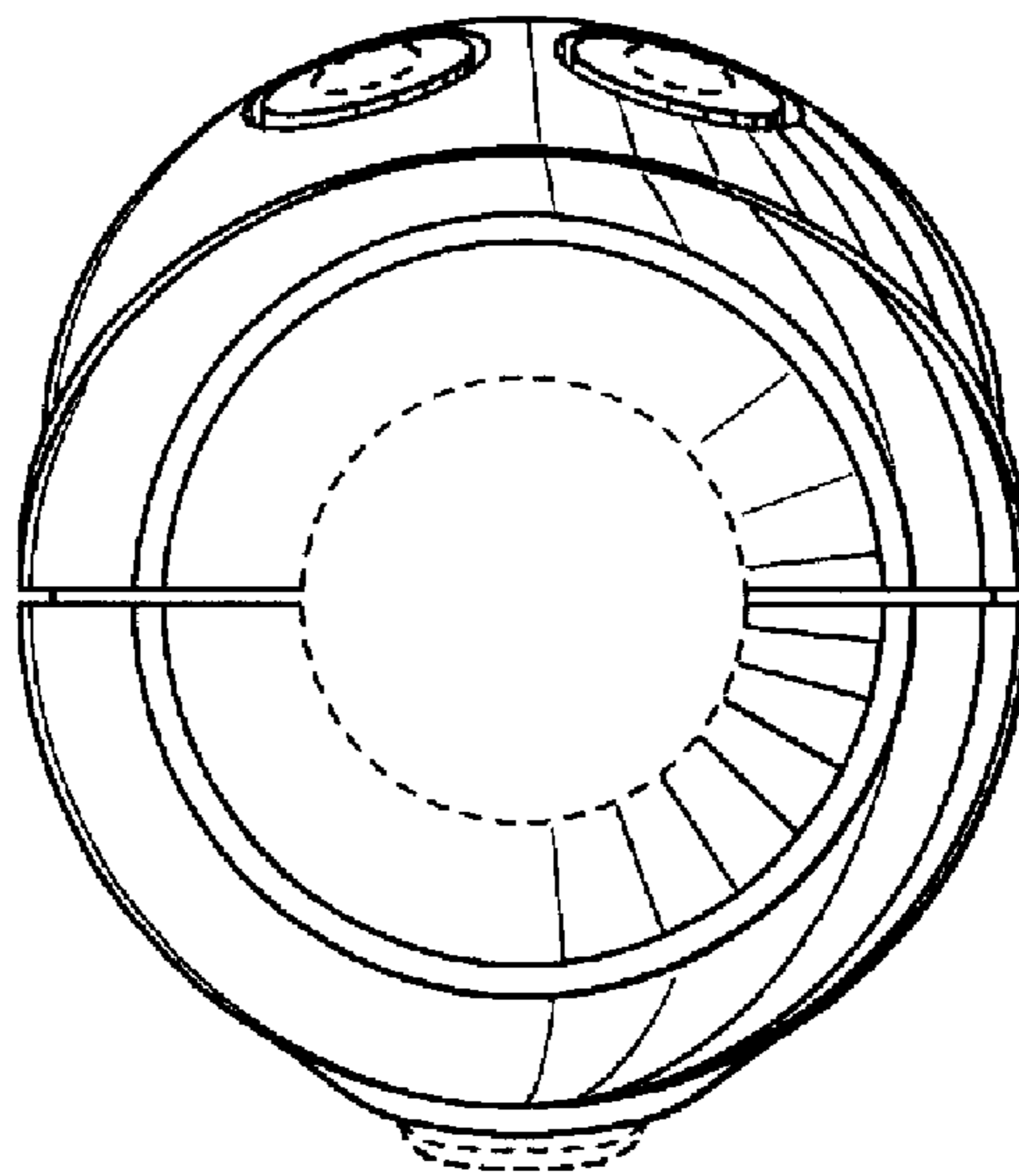

**Fig. 8**

