



US00D565925S

(12) **United States Design Patent**
Mattson et al.

(10) **Patent No.:** **US D565,925 S**

(45) **Date of Patent:** **** Apr. 8, 2008**

(54) **CABINET HANDLES**

(75) Inventors: **Deborah Mattson**, Plainwell, MI (US);
Scott A. Thor, Grand Rapids, MI (US);
Jonathan Lorenz, Grand Rapids, MI
(US); **Kevin Dewald**, Spring Lake, MI
(US)

(73) Assignee: **Hickory Hardware, Inc.**, Nashville,
TN (US)

(**) Term: **14 Years**

(21) Appl. No.: **29/279,870**

(22) Filed: **May 9, 2007**

Related U.S. Application Data

(62) Division of application No. 29/243,802, filed on Nov.
30, 2005.

(51) **LOC (8) Cl.** **08-06**

(52) **U.S. Cl.** **D8/307**

(58) **Field of Classification Search** D8/300,
D8/305, 307, 310, 313, 314, 317, 318, 319,
D8/DIG. 1, DIG. 2; D23/250–253; 16/330,
16/441, 443, 444, 446, 414, 417; D6/373,
D6/376; 70/452; 292/347, 348, 356
See application file for complete search history.

(56) **References Cited**

U.S. PATENT DOCUMENTS

434,650	A *	8/1890	Adams	16/417
885,687	A *	4/1908	Chenoweth	16/414
D64,095	S *	2/1924	Yates	D8/307
1,611,753	A *	12/1926	Keeler et al.	292/347
1,666,731	A *	4/1928	Broomhall	292/356
D208,690	S *	9/1967	Morgan	D8/316
4,193,166	A *	3/1980	Neff	16/441

D455,196	S *	4/2002	Caplow	D23/249
D473,932	S *	4/2003	Caplow	D23/252
D518,152	S *	3/2006	Theberge	D23/252
D542,622	S *	5/2007	Ricereto	D8/307

OTHER PUBLICATIONS

Rockler Woodworking and Hardware Summer 2002 p. 63.*

* cited by examiner

Primary Examiner—Paula A. Greene

(74) *Attorney, Agent, or Firm*—Perman & Green, LLP

(57) **CLAIM**

The ornamental design for cabinet handles, as shown and described.

DESCRIPTION

FIG. 1 is perspective view of a first handle.
 FIG. 2 is a perspective view of a second handle
 FIG. 3 is a perspective view a third handle.
 FIG. 4 is a front view of the handle shown in FIG. 3.
 FIG. 5 is a bottom view of the handle shown in 3.
 FIG. 6 is a side view of the handle shown in 3.
 FIG. 7 is front view of the handle shown in FIG. 2.
 FIG. 8 is a bottom view of the handle shown in 2.
 FIG. 9 is a side view of the handle shown in 2.
 FIG. 10 is a front view of the handle shown in FIG. 1.
 FIG. 11 is a bottom view of the handle shown in FIG. 1; and,
 FIG. 12 is a side view of the handle shown in FIG. 1.
 Portions of FIGS. 1–12 that are shown as broken lines are for illustrative purposes only and form no part of the claimed design.

1 Claim, 4 Drawing Sheets

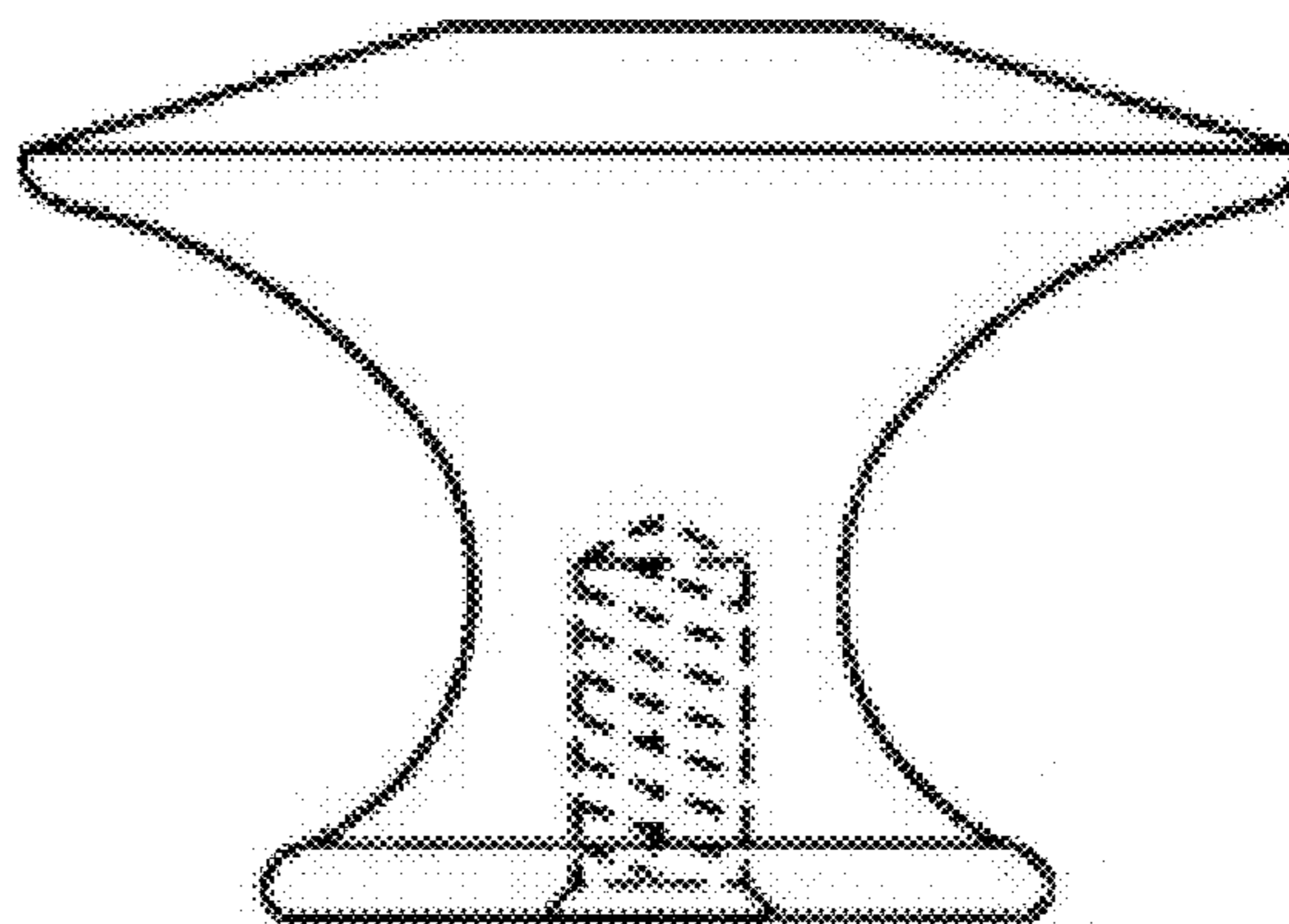
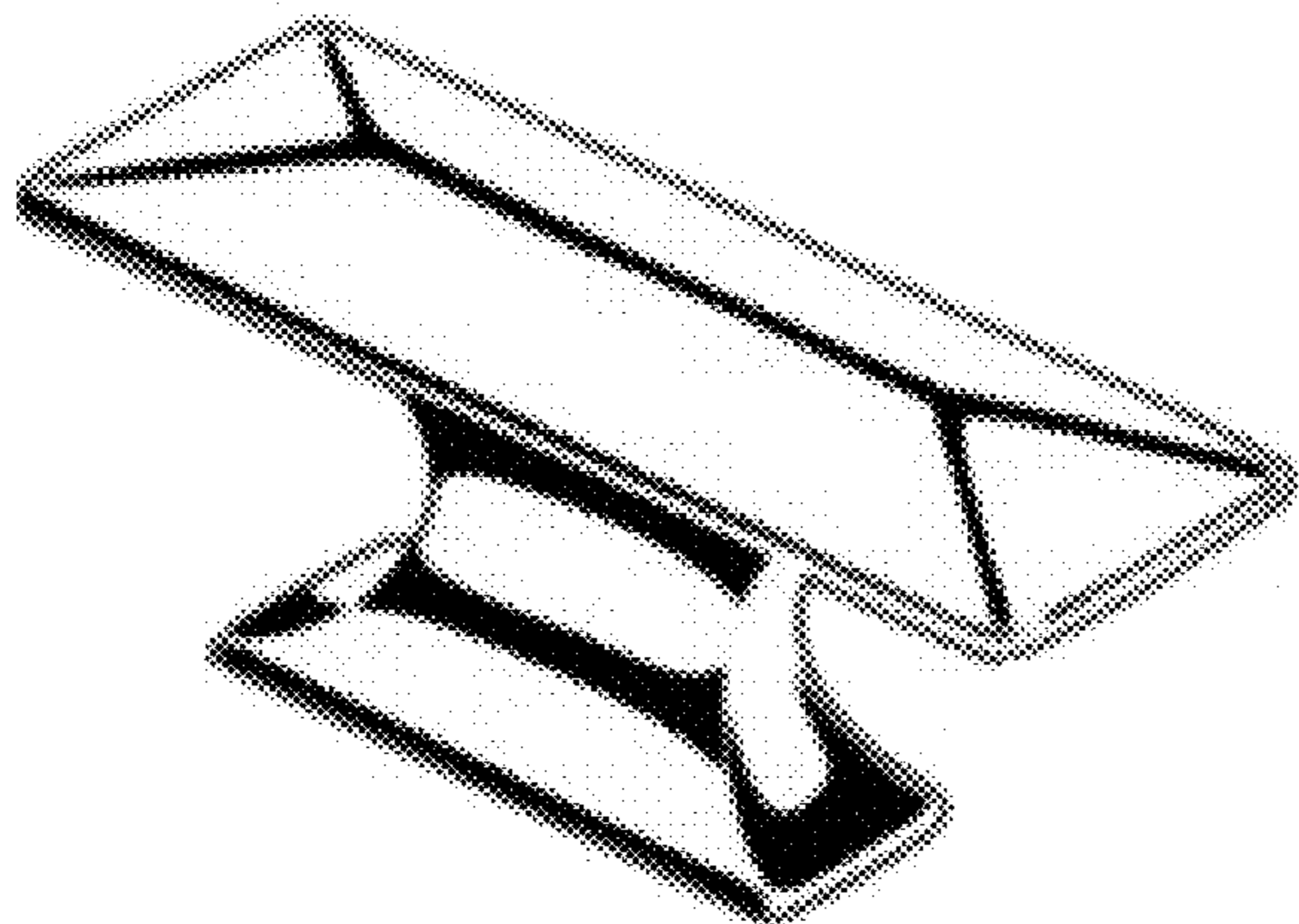

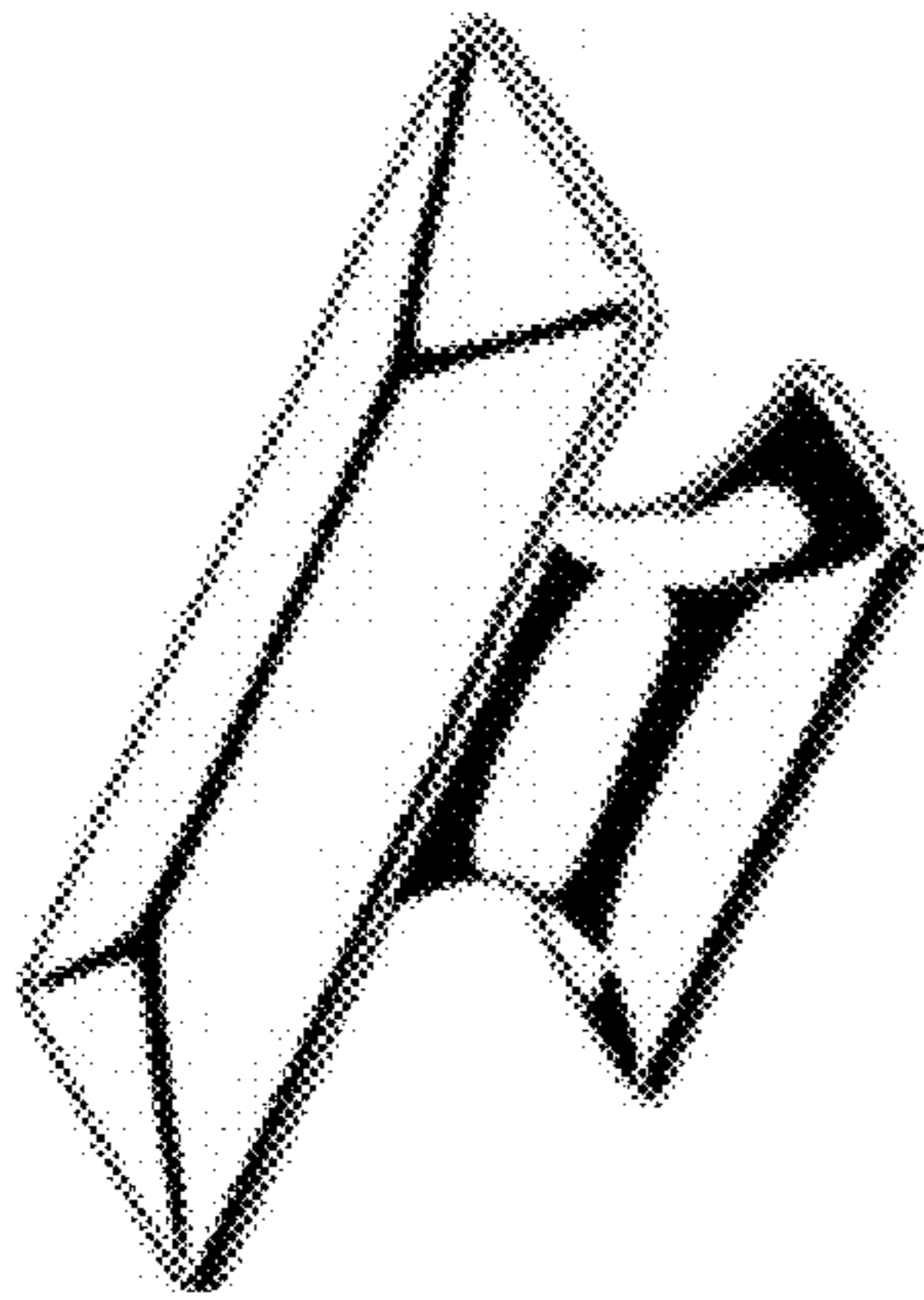

FIG. 1

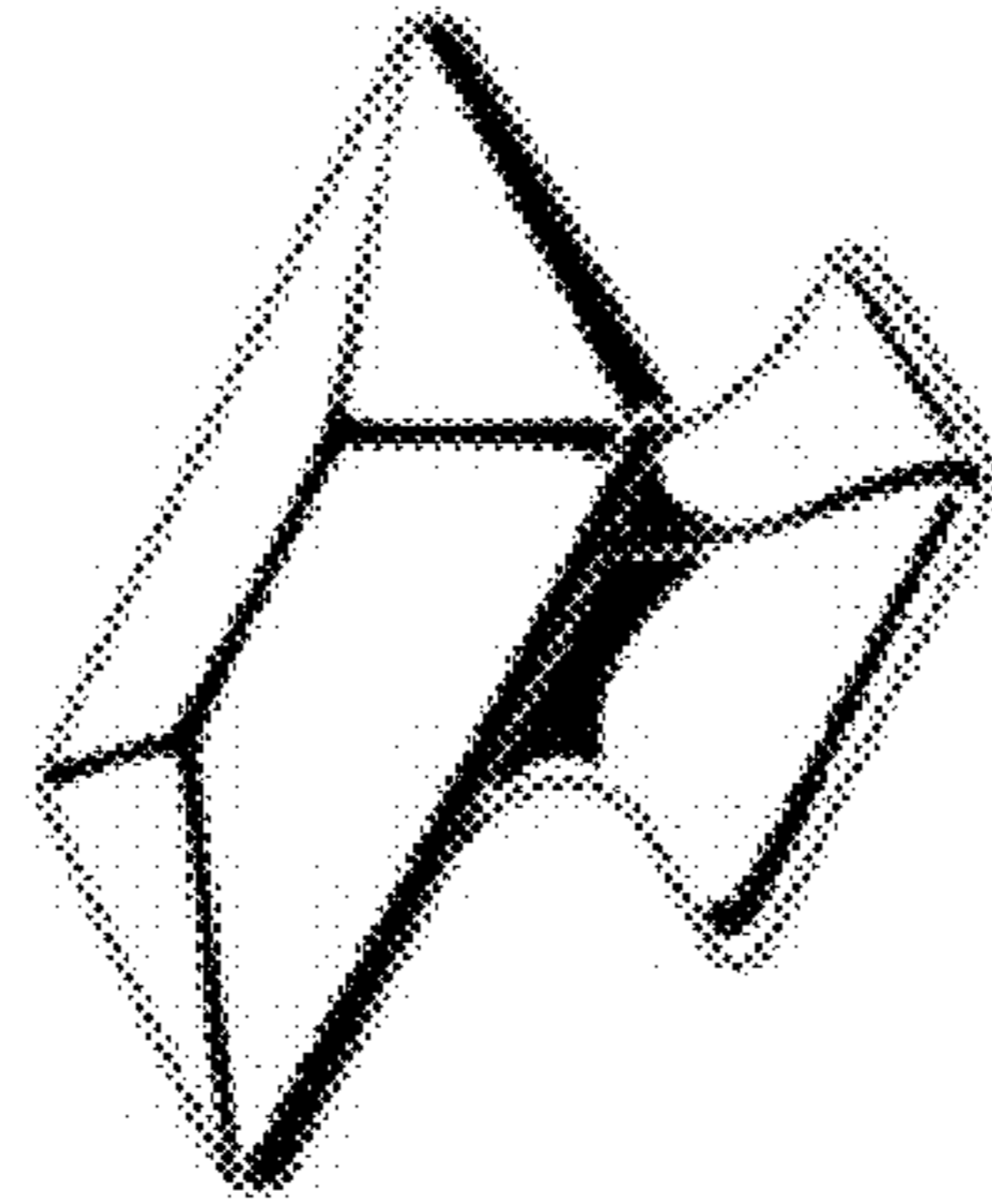

FIG. 2

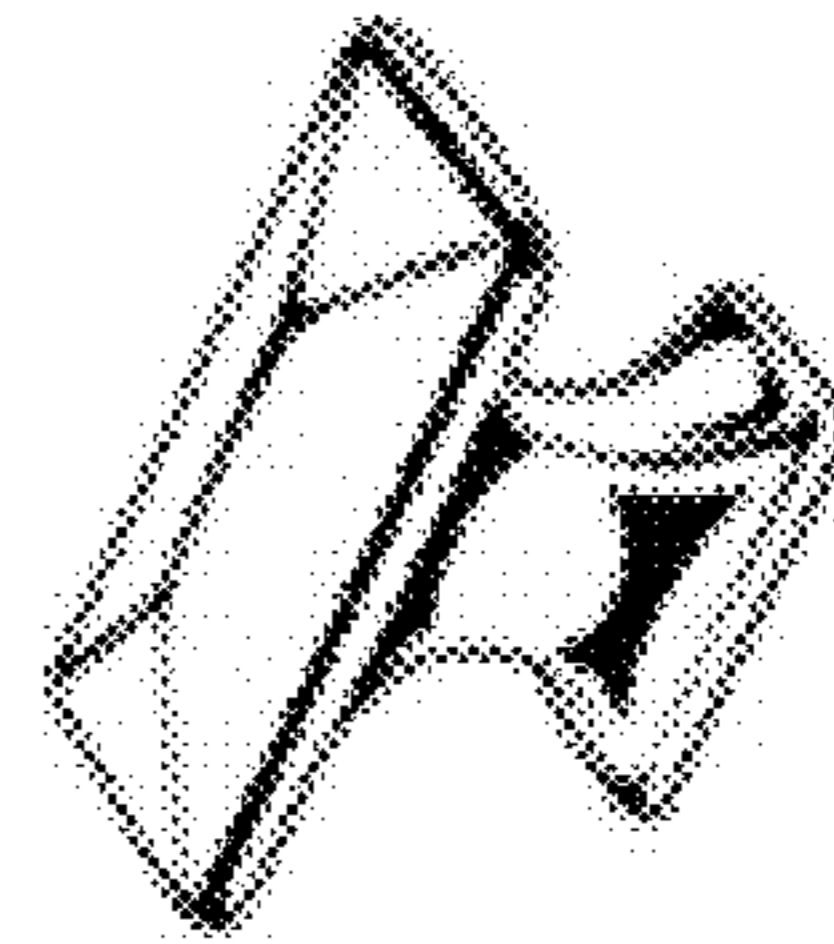

FIG. 3

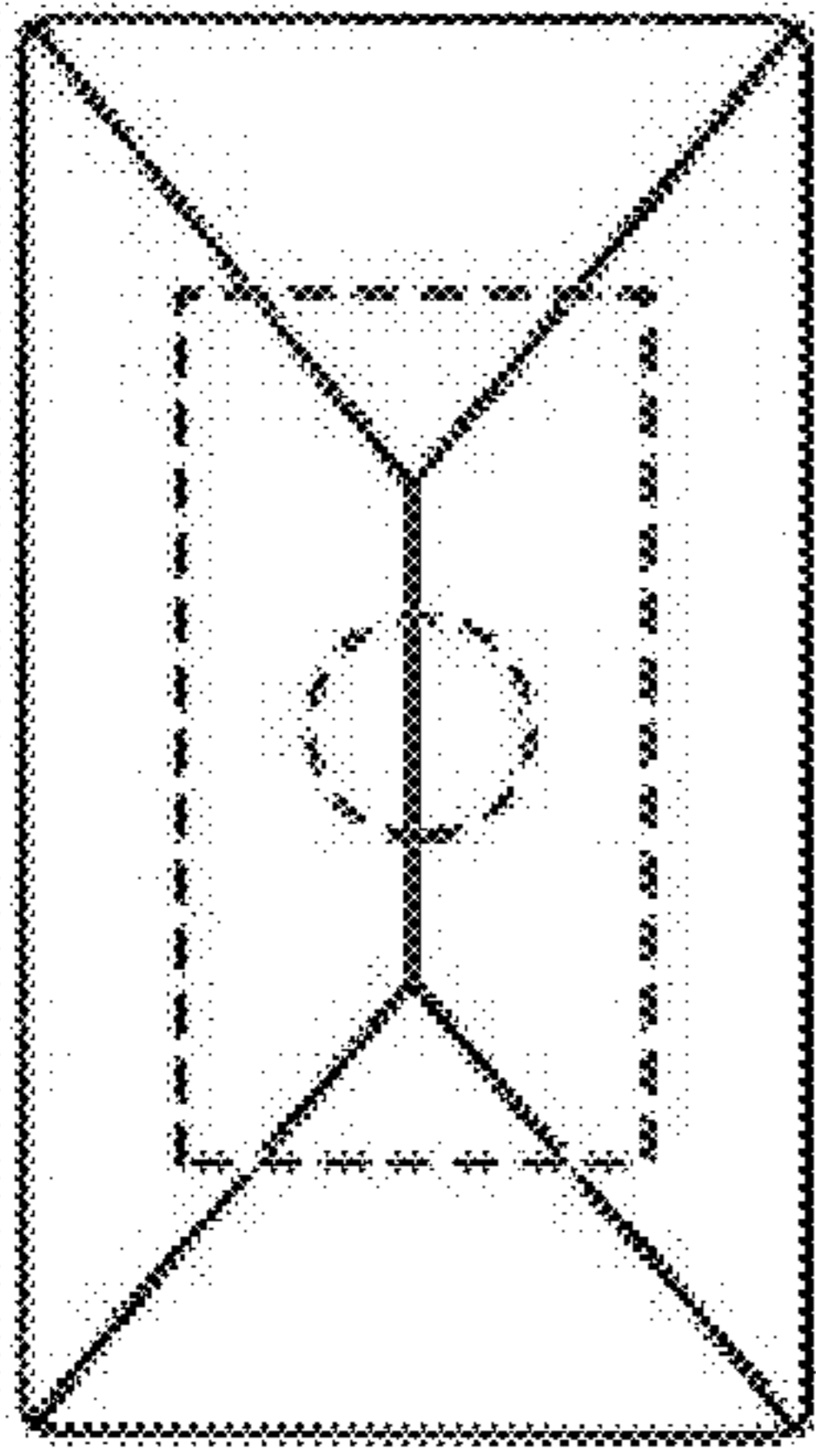

FIG. 4

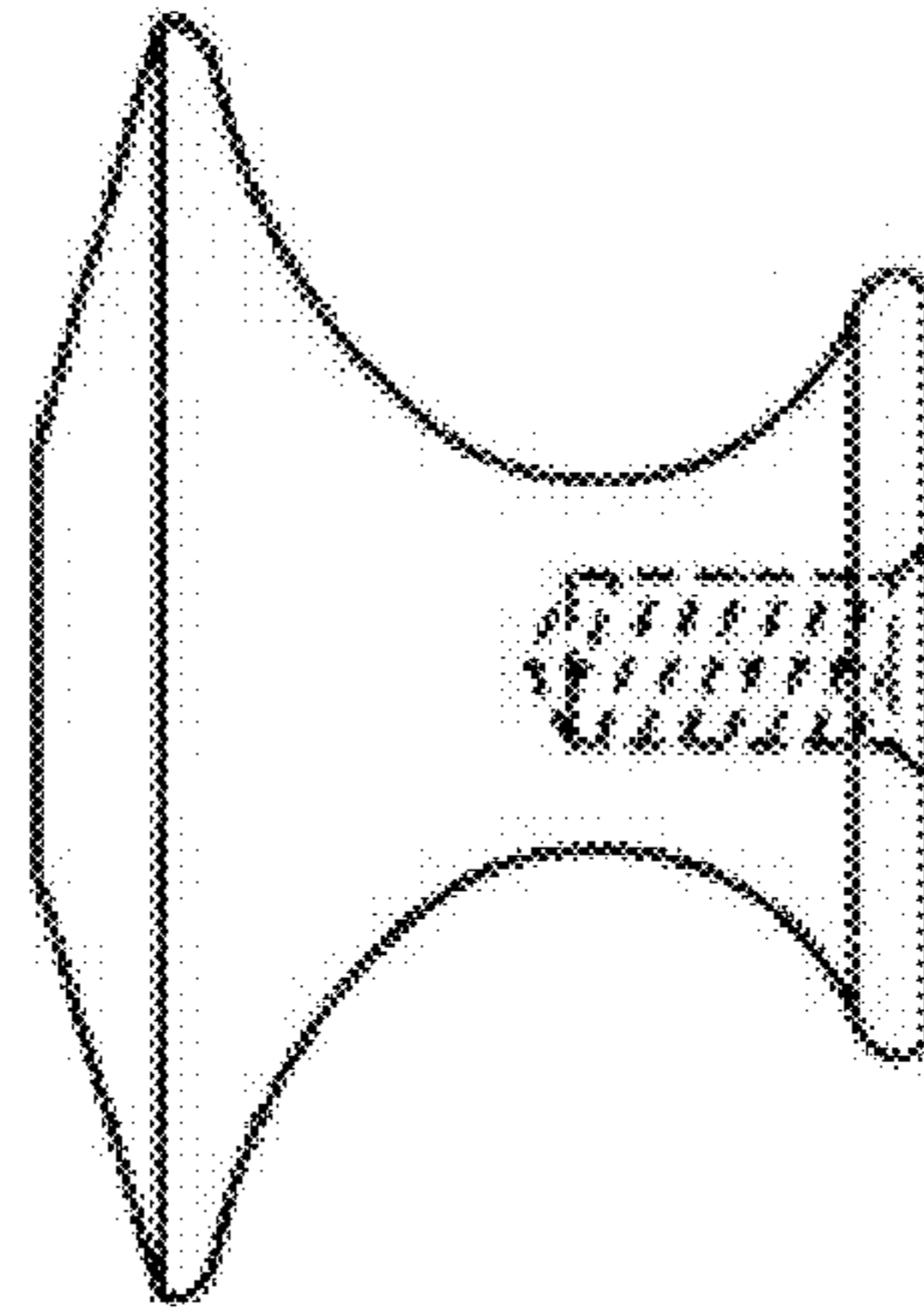

FIG. 5

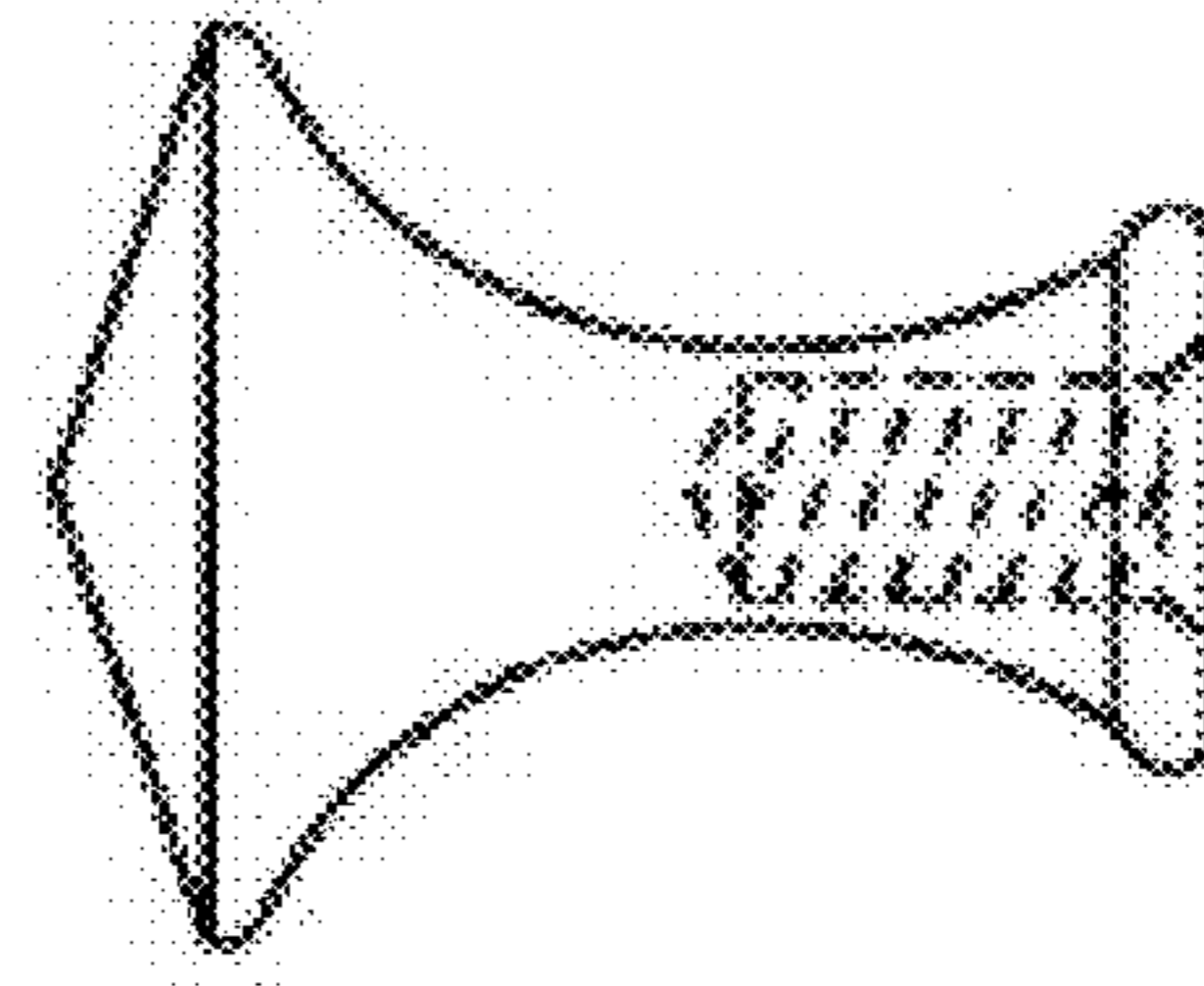

FIG. 6

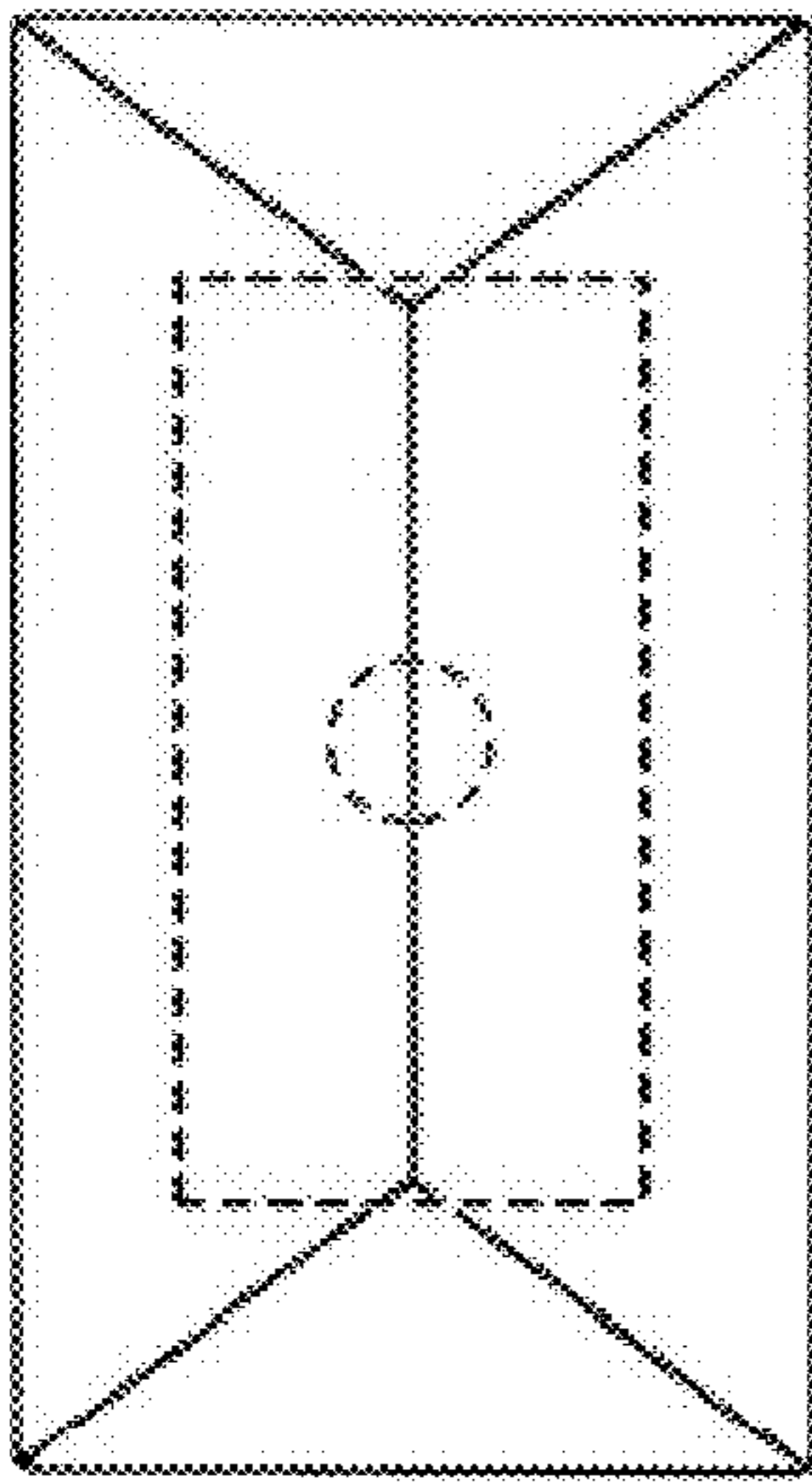

FIG. 7

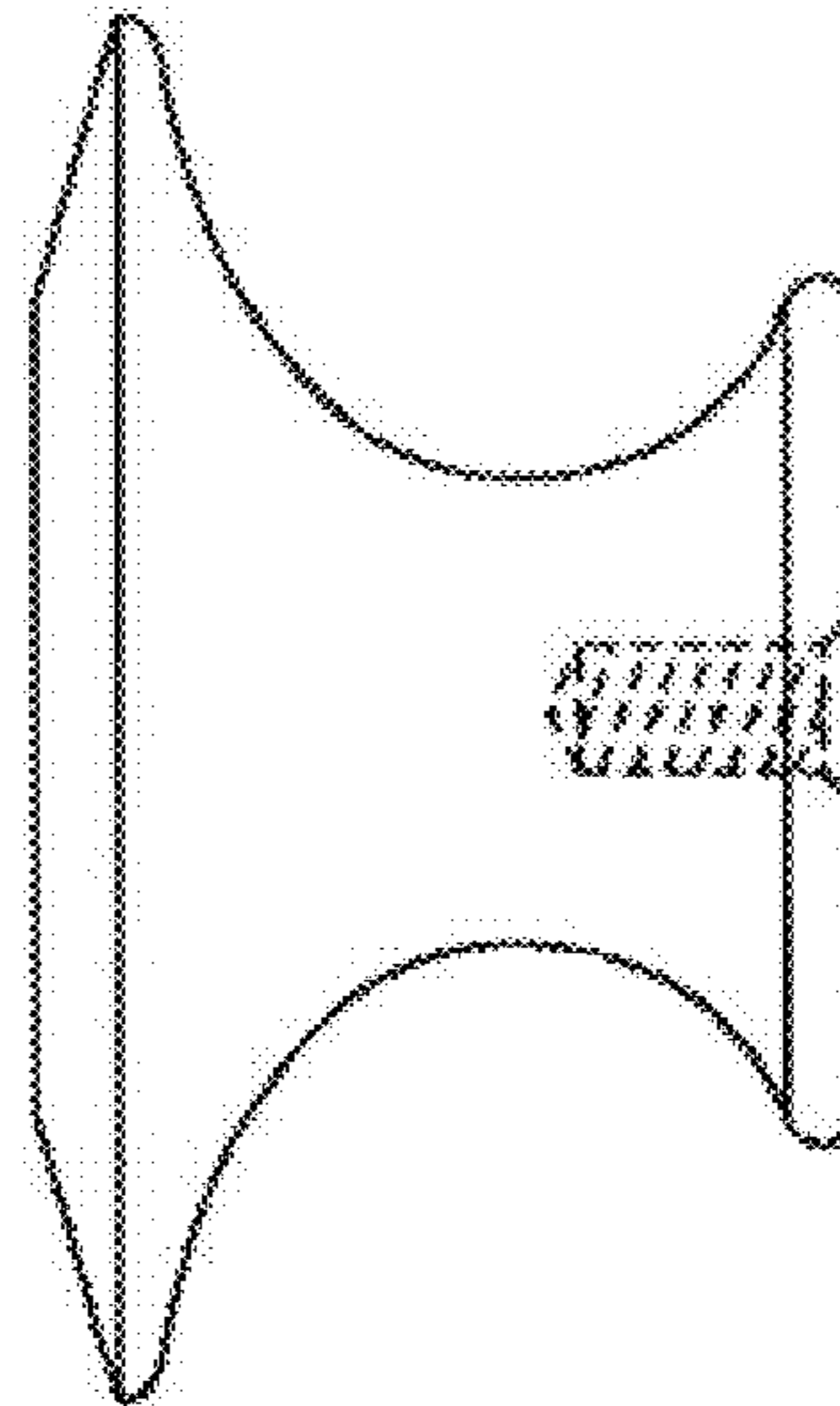

FIG. 8

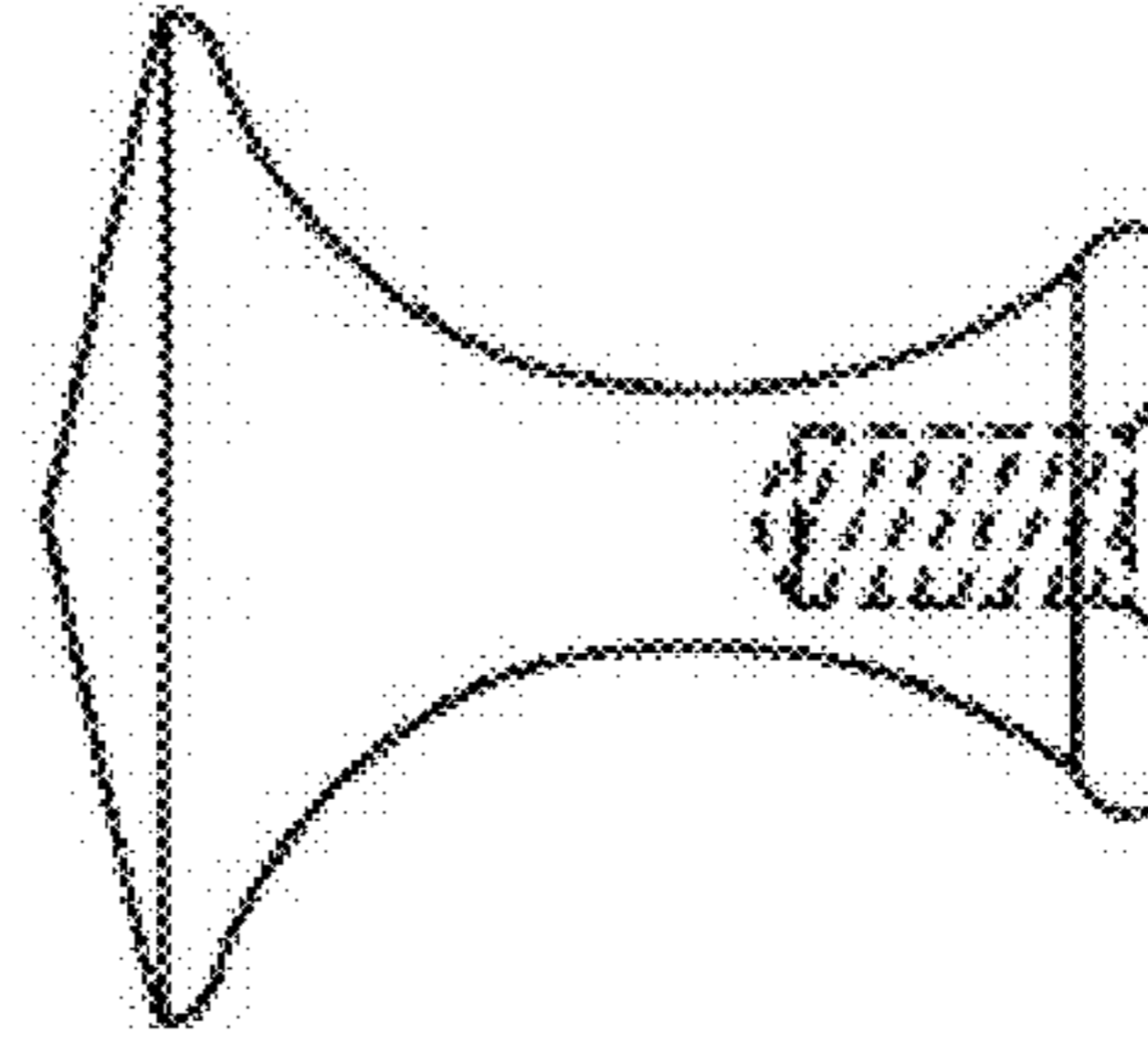

FIG. 9

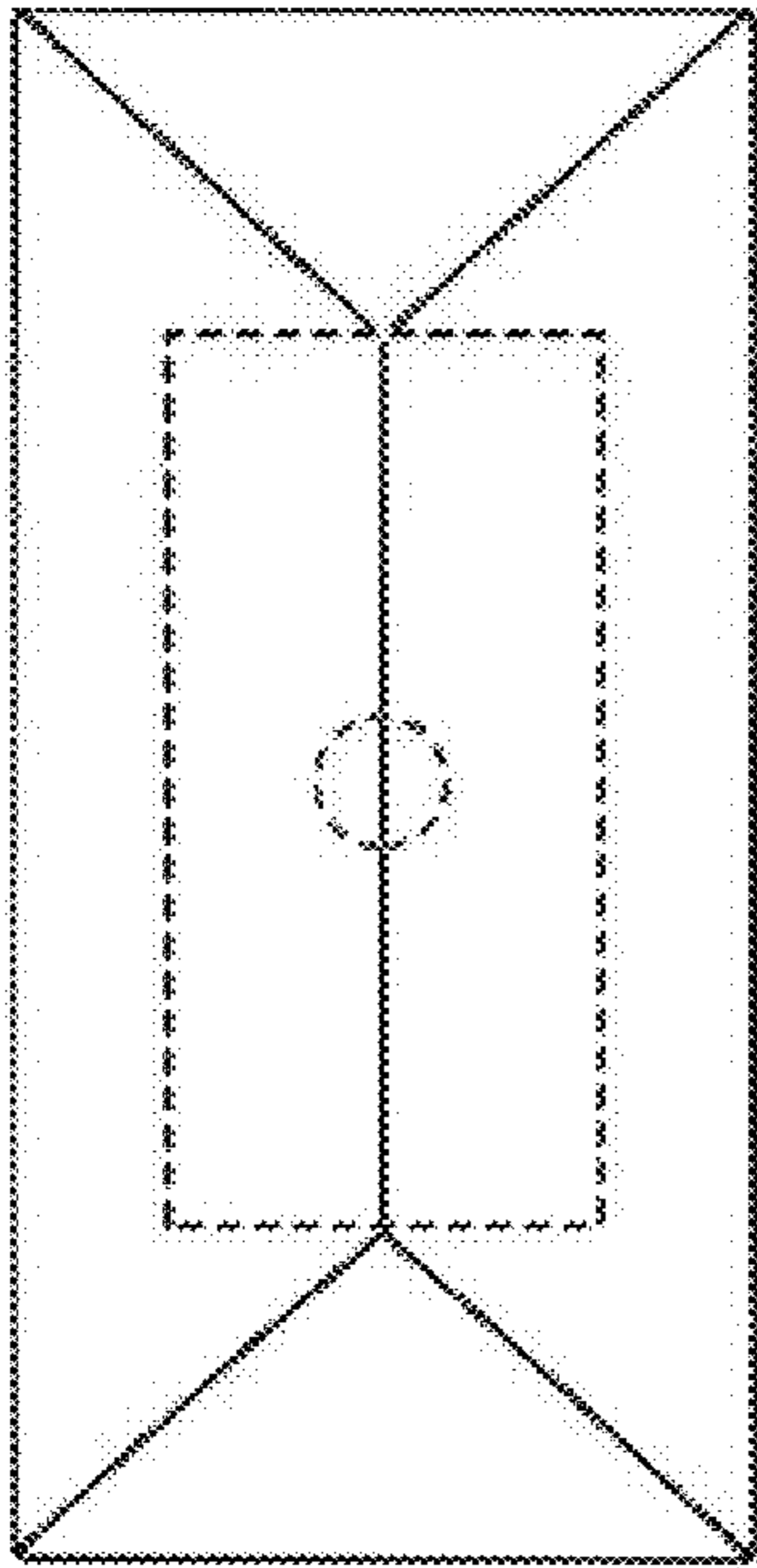

FIG. 10

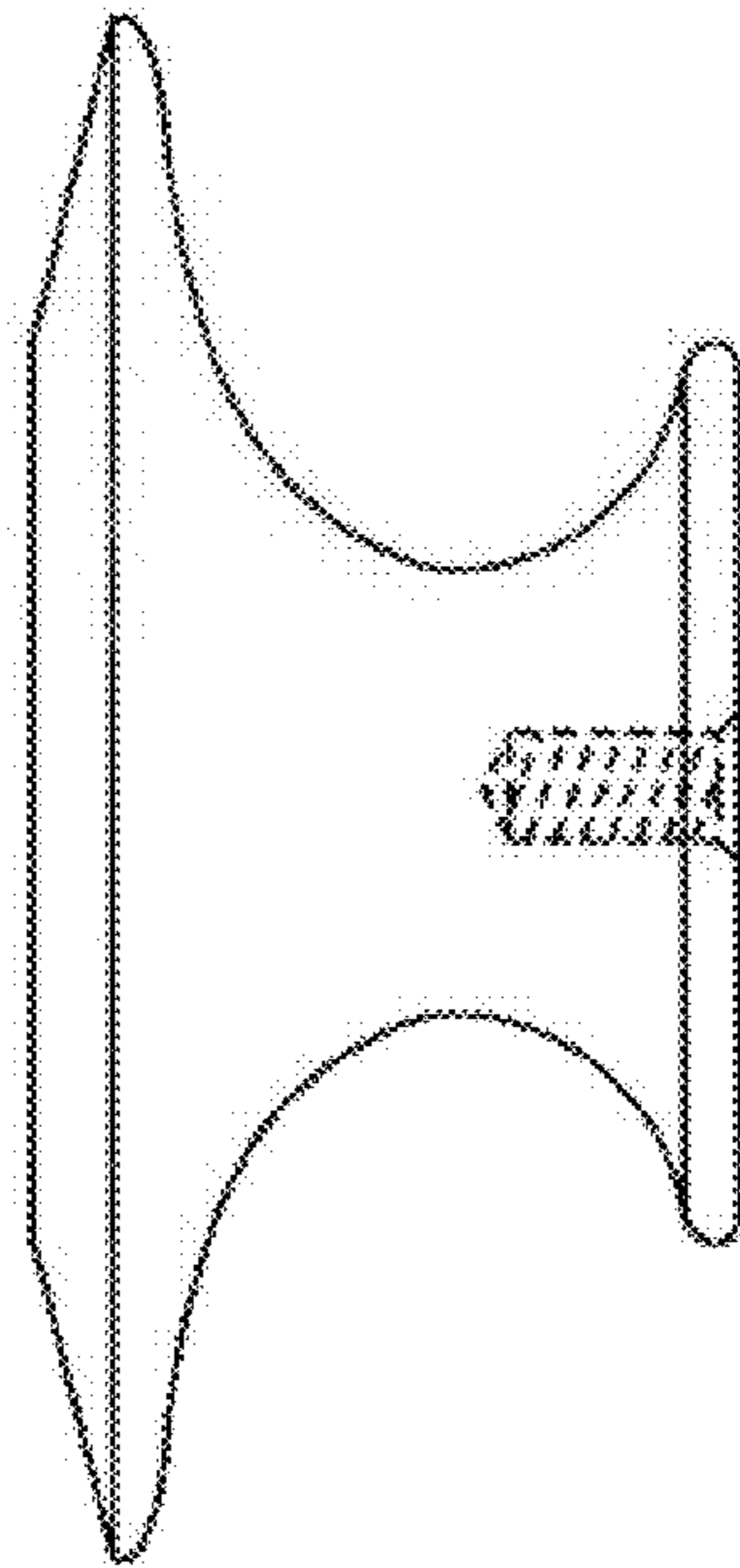

FIG. 11

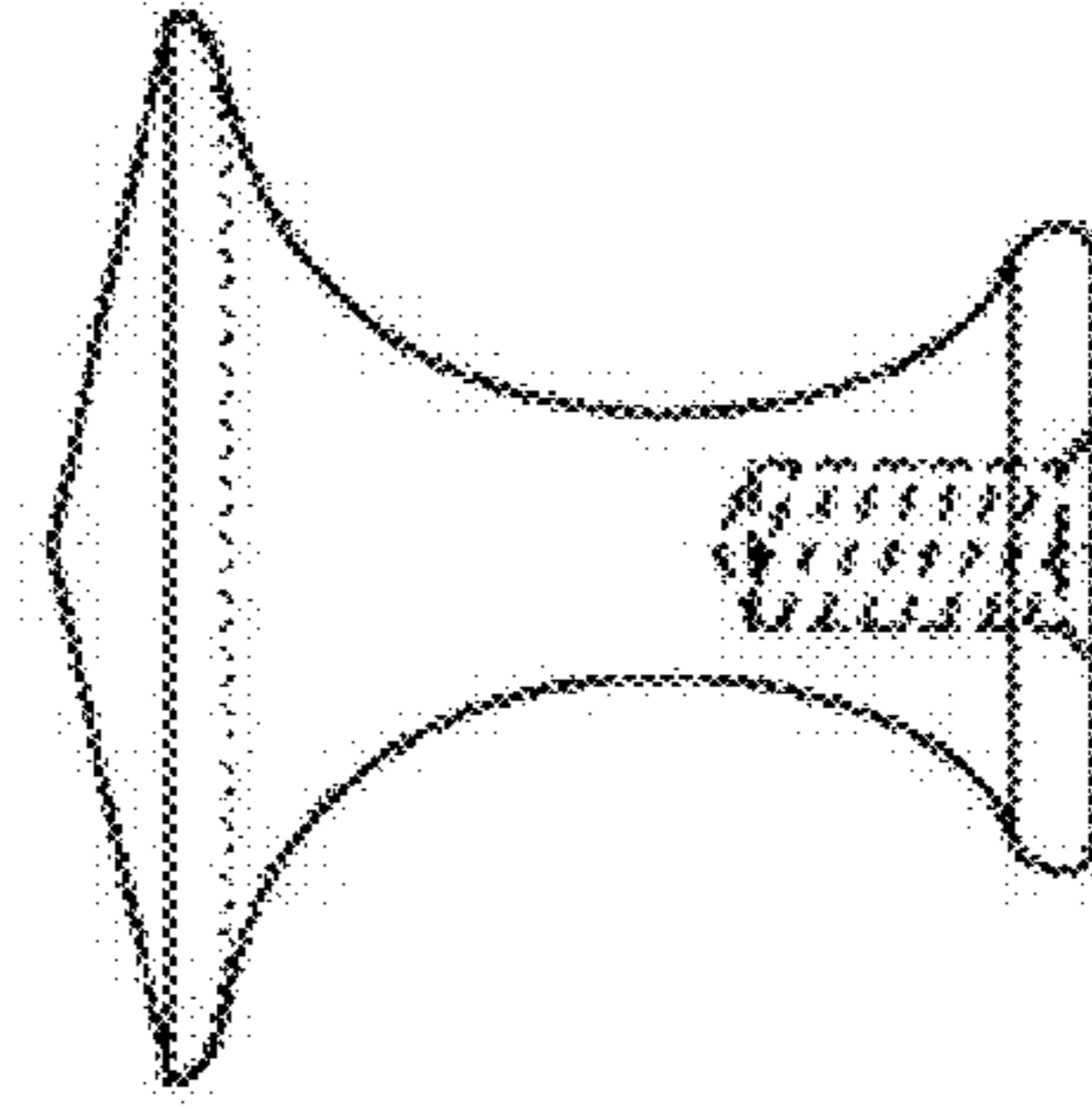

FIG. 12