



US00D565888S

(12) **United States Design Patent**
Frank

(10) **Patent No.:** **US D565,888 S**

(45) **Date of Patent:** **** Apr. 8, 2008**

(54) **MICROWAVE OVEN**

(75) Inventor: **Tim Frank**, Asheville, NC (US)

(73) Assignee: **The Frank Group LLC**, Asheville, NC (US)

(**) Term: **14 Years**

(21) Appl. No.: **29/285,513**

(22) Filed: **Mar. 30, 2007**

(51) **LOC (8) Cl.** **07-02**

(52) **U.S. Cl.** **D7/351**

(58) **Field of Classification Search** D7/350.1,
D7/350.3-350.4, 351, 402, 405, 339-340,
D7/348-349; 126/19 M, 21 R, 275 E, 273 A;
219/756-758

See application file for complete search history.

(56) **References Cited**

U.S. PATENT DOCUMENTS

D176,084 S *	11/1955	Sado	D7/350.4
3,973,165 A	8/1976	Hester		
4,667,075 A	5/1987	Sakurai		
4,886,951 A	12/1989	Matsumoto et al.		
4,904,837 A	2/1990	Low et al.		
5,224,027 A	6/1993	Kyong-keun		
5,237,140 A	8/1993	Akazawa et al.		
5,268,547 A	12/1993	Bessyo et al.		
5,274,208 A	12/1993	Noda		
5,276,300 A	1/1994	Low et al.		
5,331,128 A	7/1994	Koh		
5,347,109 A	9/1994	Nakabayashi et al.		
D352,866 S *	11/1994	Kindley et al.	D7/351

(Continued)

FOREIGN PATENT DOCUMENTS

JP	63308890 A	12/1988
JP	02260332 A2	4/1991
JP	03095890 A	4/1991

JP	04137481 A	5/1992
JP	06349571 A	12/1994
JP	07130462 A	5/1995
JP	07226166 A	8/1995
JP	07282970 A	10/1995
JP	08050990 A	2/1996
JP	09060888 A	3/1997
JP	09129147 A2	5/1997
JP	11162629 A	6/1999
JP	11288782 A	10/1999
JP	2002270360 A	9/2002
JP	2002299033 A	10/2002
JP	2003257612 A	9/2003
JP	2003308959 A	10/2003
JP	2004103351 A	4/2004
JP	2005005085 A	1/2005
JP	2006228596 A	8/2005

Primary Examiner—Ruth McInroy

(57) **CLAIM**

The ornamental design for a microwave oven, as shown and described.

DESCRIPTION

FIG. 1 is a perspective view of a microwave oven in accordance with my new design;

FIG. 2 is a front elevational view thereof;

FIG. 3 is a rear elevational view thereof;

FIG. 4 is a top plan view thereof;

FIG. 5 is a bottom plan view thereof;

FIG. 6 is a left elevational view thereof;

FIG. 7 is a right elevational view thereof; and,

FIG. 8 is a perspective view thereof, with the door to the oven chamber in an open position.

The details shown in broken lines form no part of the claimed design.

1 Claim, 8 Drawing Sheets

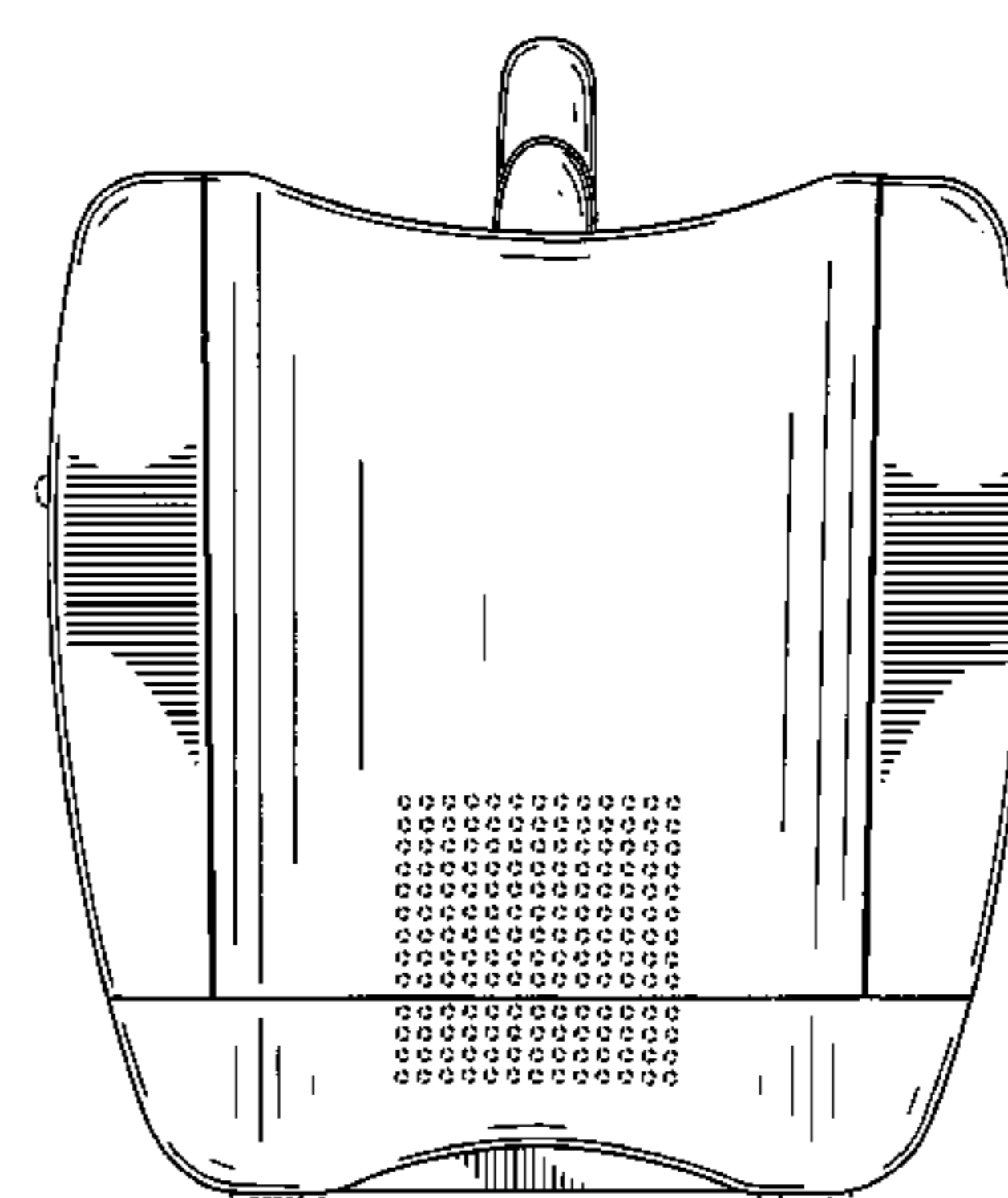
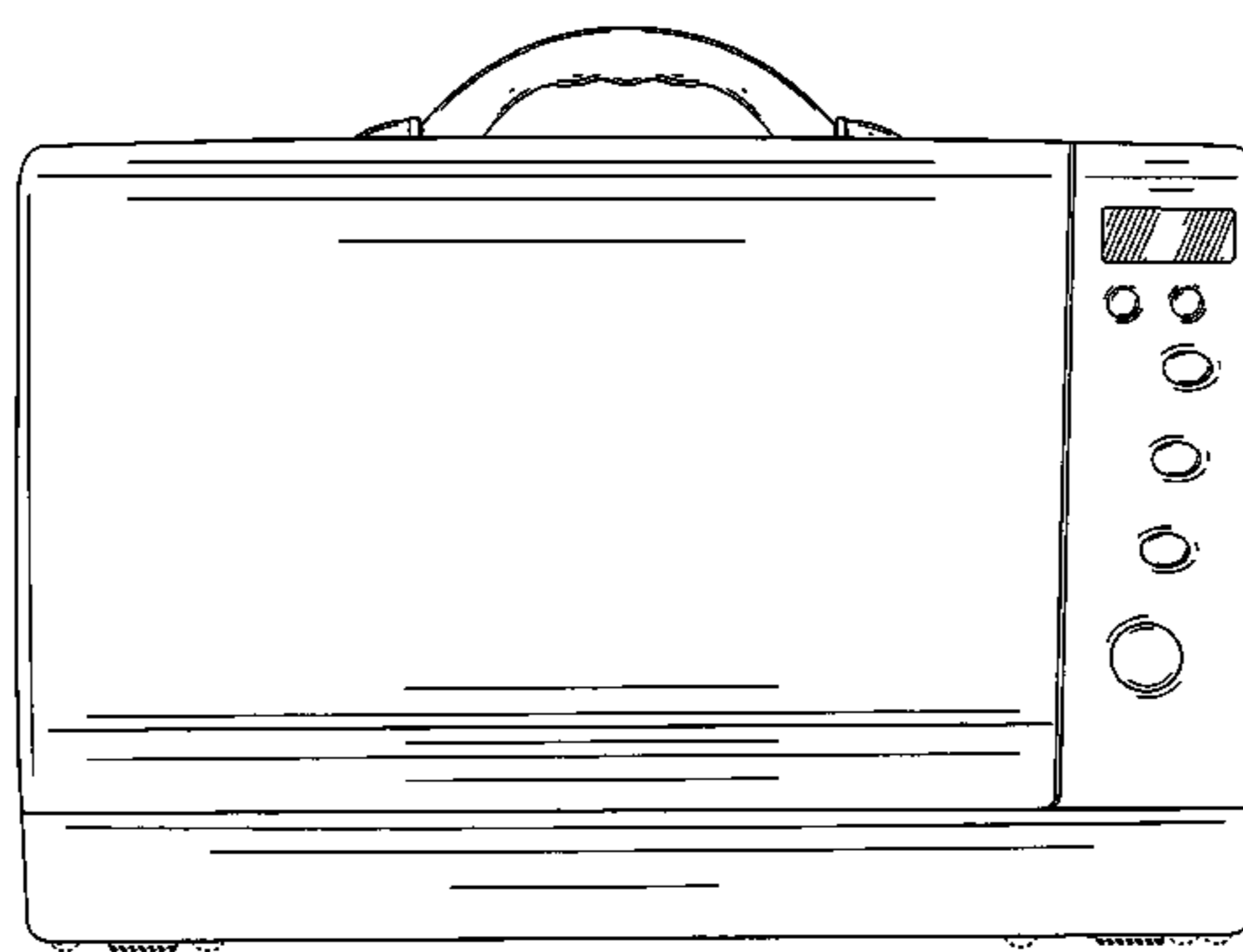
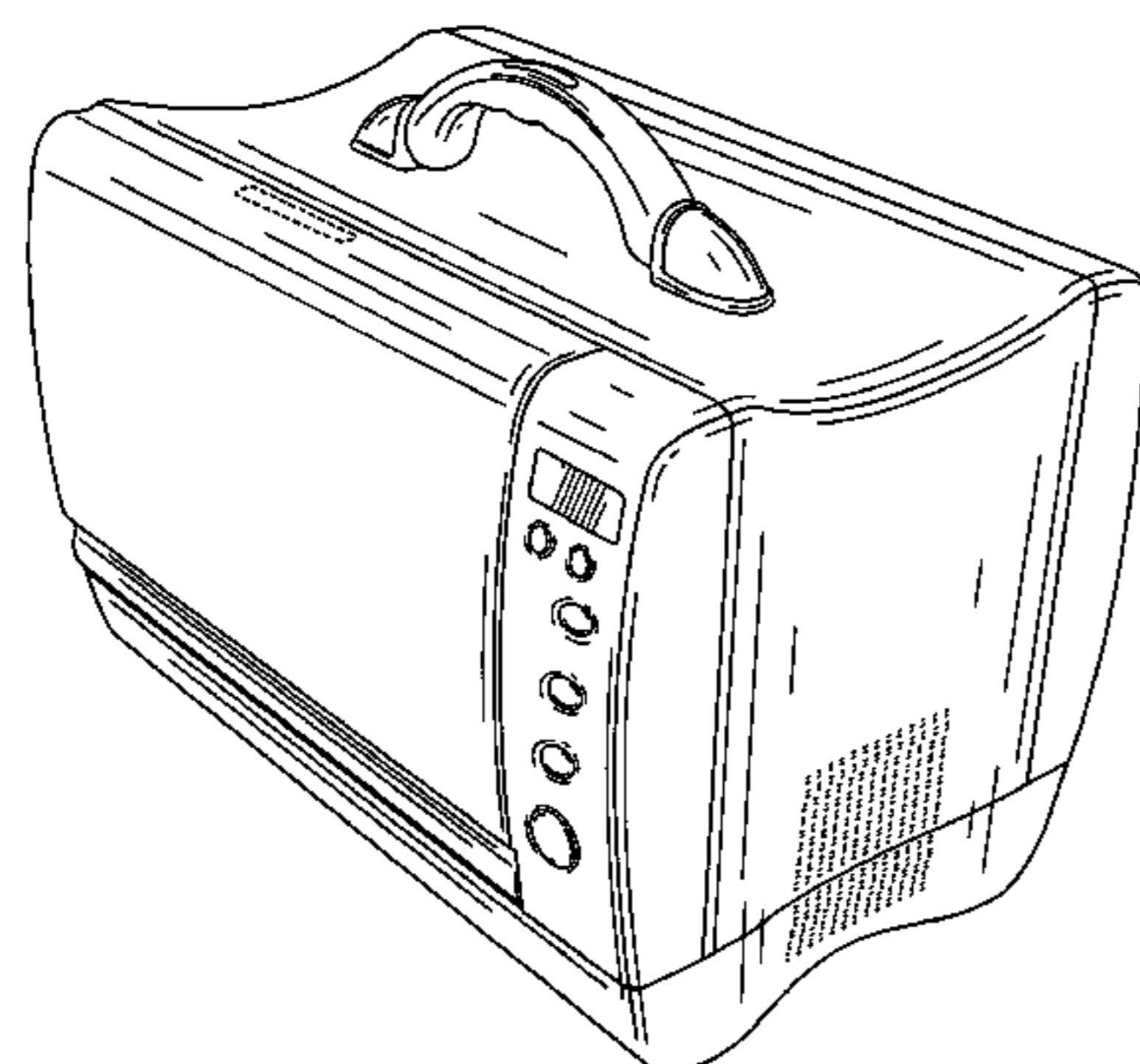

US D565,888 S

Page 2

U.S. PATENT DOCUMENTS

5,369,255	A	11/1994	Sherer et al.				
5,642,268	A	6/1997	Pratt et al.				
D411,407	S *	6/1999	Anthony	D7/351			
5,977,530	A	11/1999	Bessho et al.				
D425,359	S *	5/2000	Seiz	D7/351			
6,060,700	A	5/2000	Perlman et al.				
6,153,869	A	11/2000	Kim et al.				
6,153,870	A	11/2000	Kim et al.				
D443,171	S *	6/2001	Chen	D7/350.4			
D449,761	S *	10/2001	Loftis et al.	D7/351			
6,362,463	B1	3/2002	Bessyo et al.				
D456,665	S *	5/2002	Wright	D7/350.4			
6,448,541	B1	9/2002	Lim				
6,624,579	B2	9/2003	Yasui et al.				
6,744,209	B2	6/2004	Jang et al.				
6,759,636	B2	7/2004	Stutman				
6,856,095	B2	2/2005	Zeng et al.				
6,884,977	B2	4/2005	Han et al.				
D533,012	S *	12/2006	Massaloux et al.	D7/350.1			

* cited by examiner

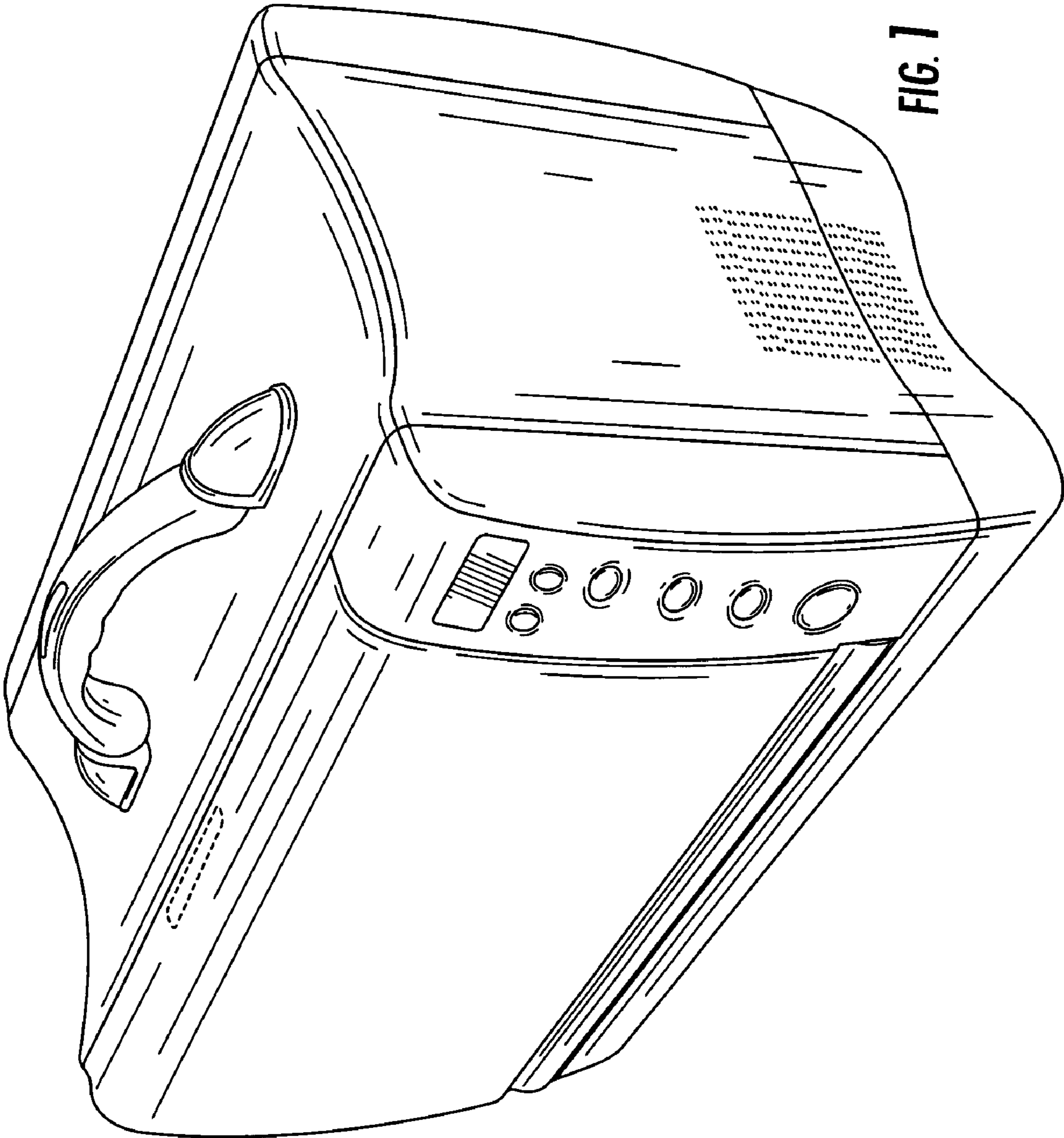

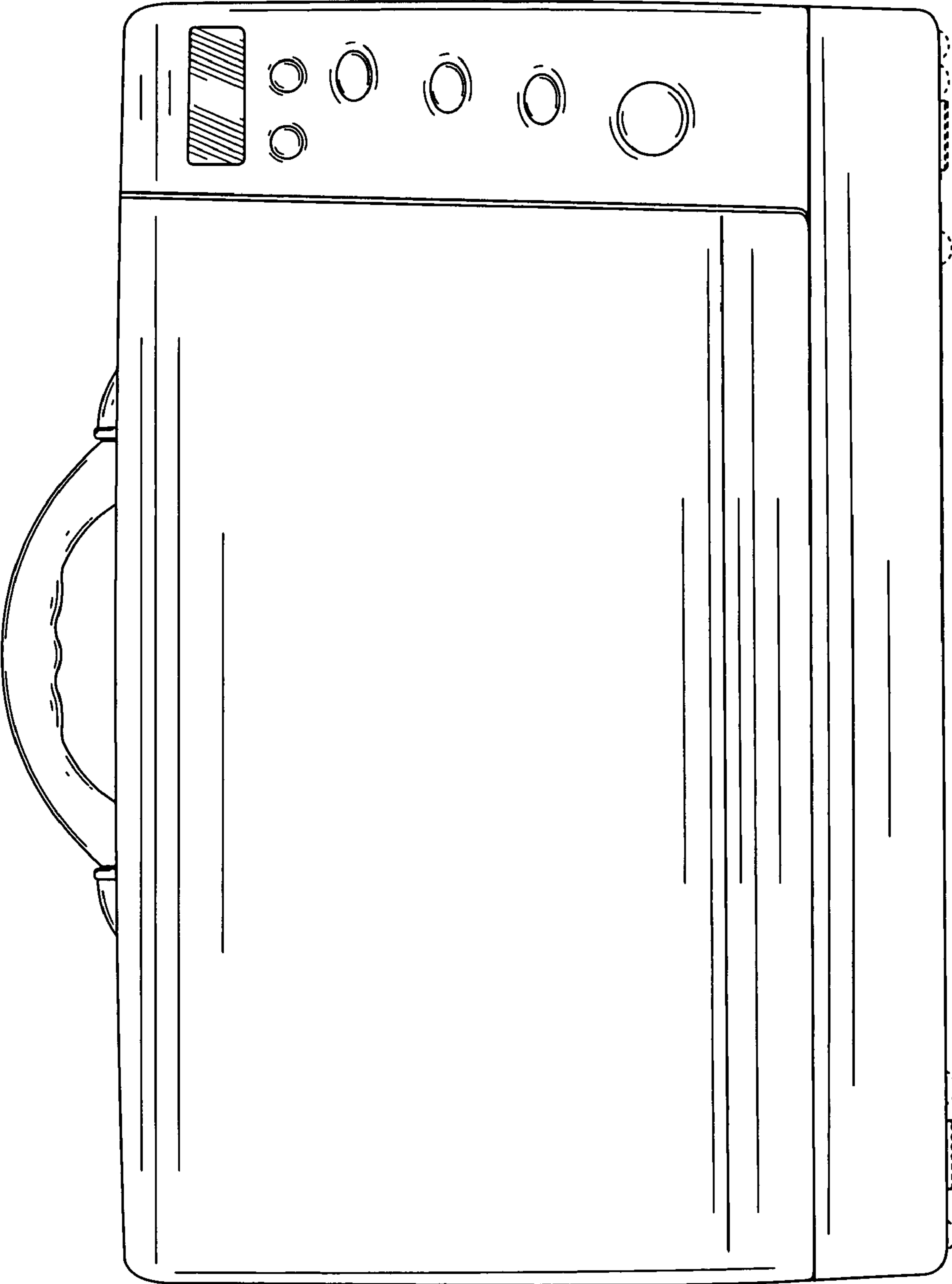

FIG. 2

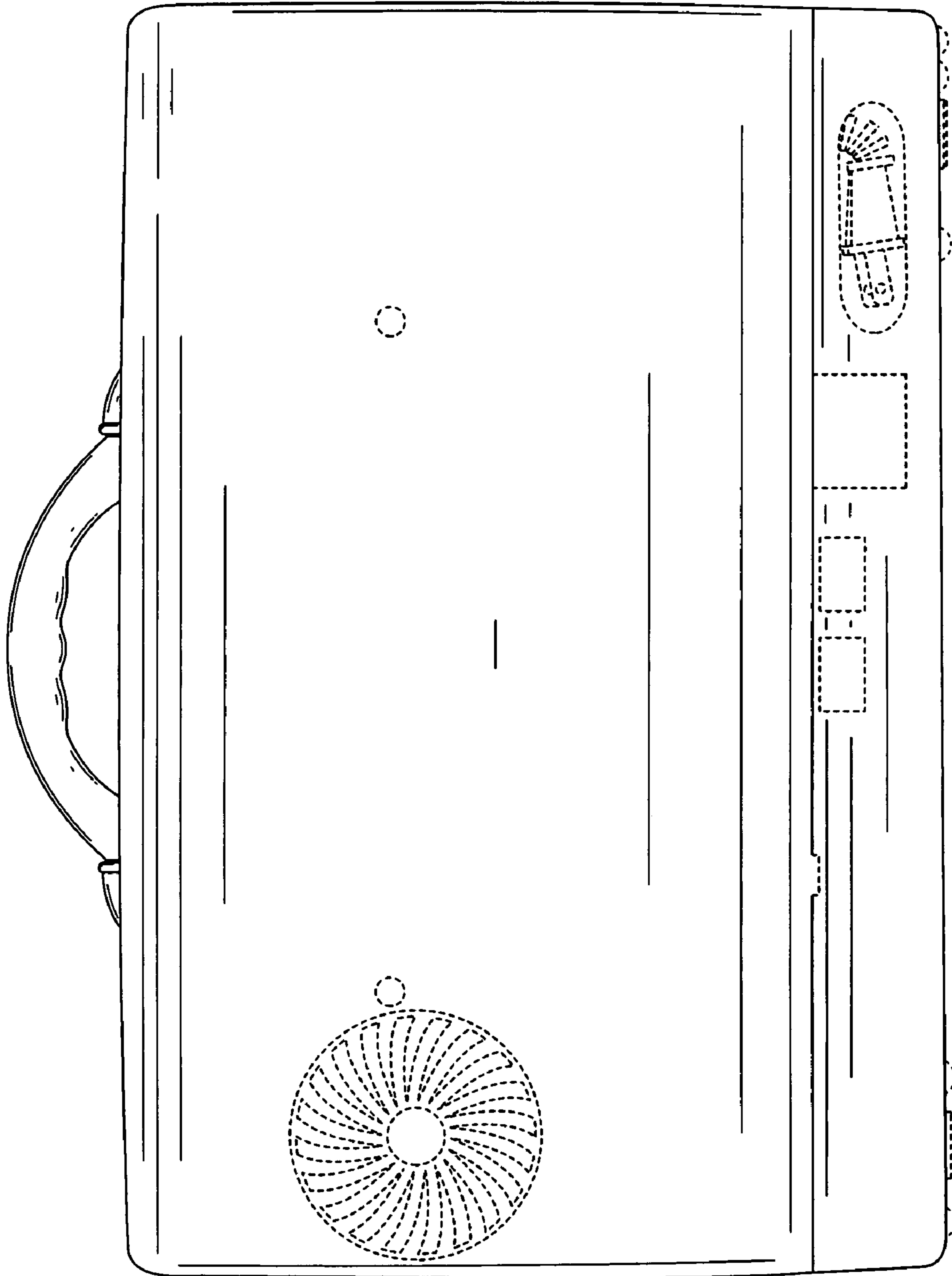

FIG. 3

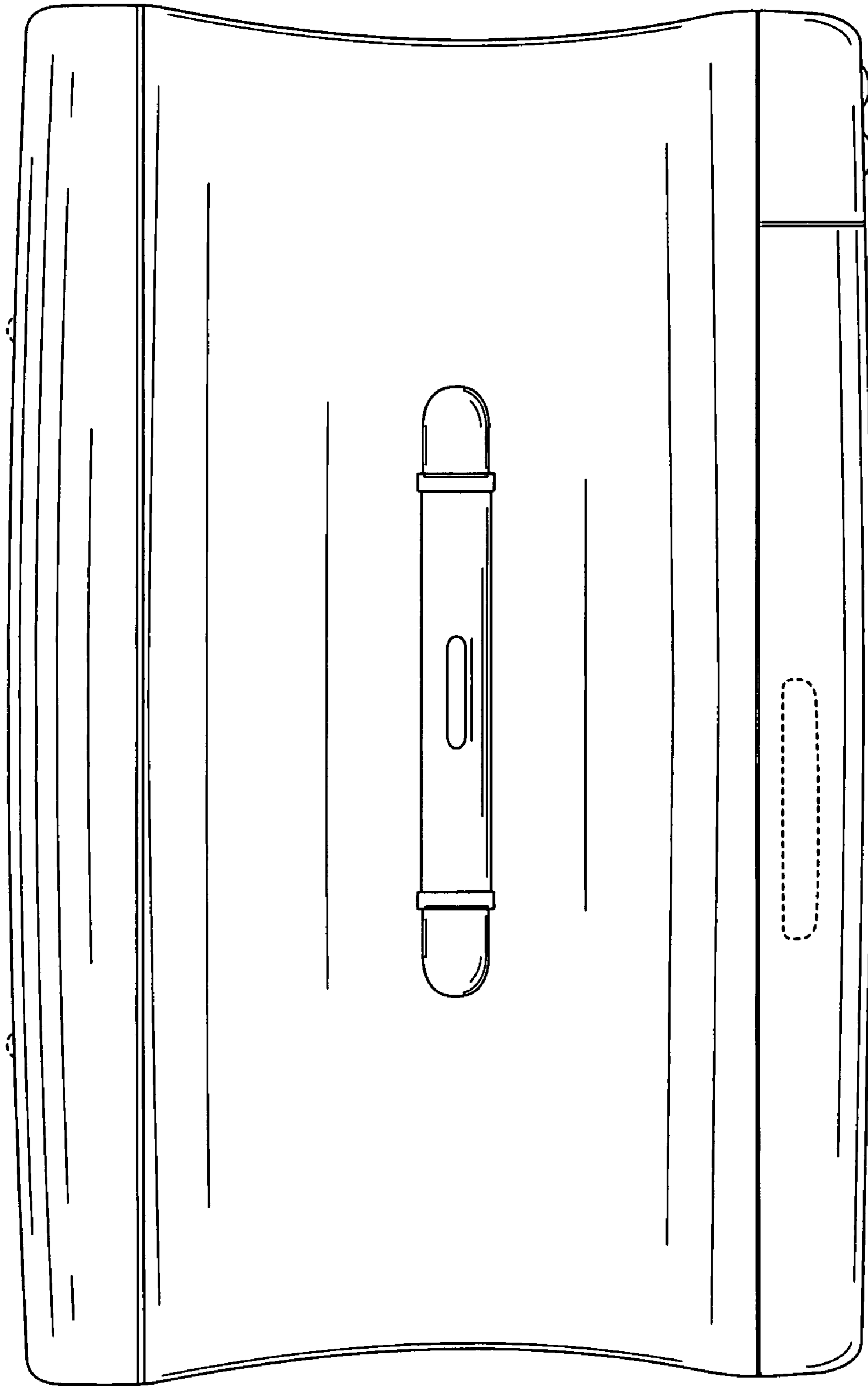

FIG. 4

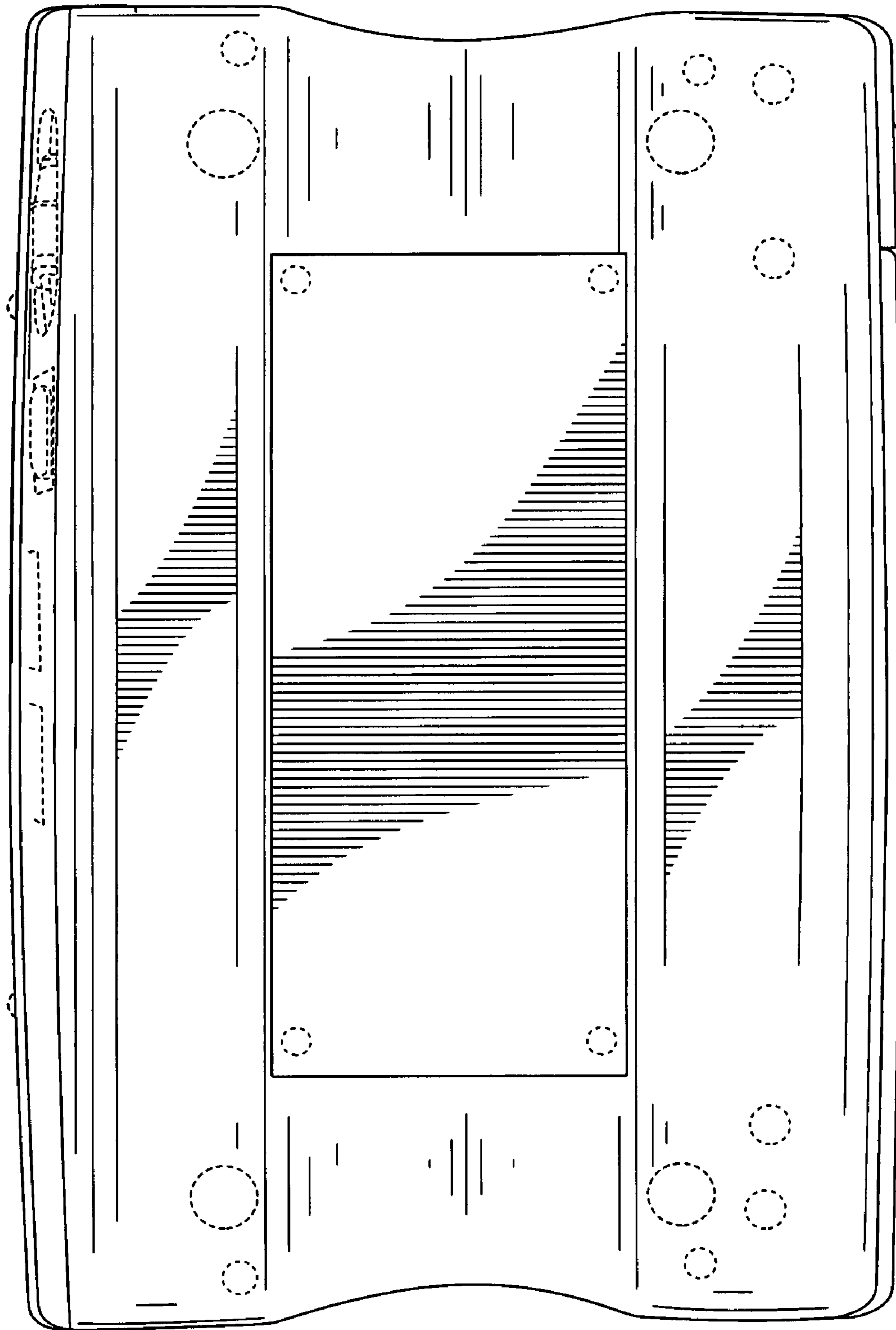

FIG. 5

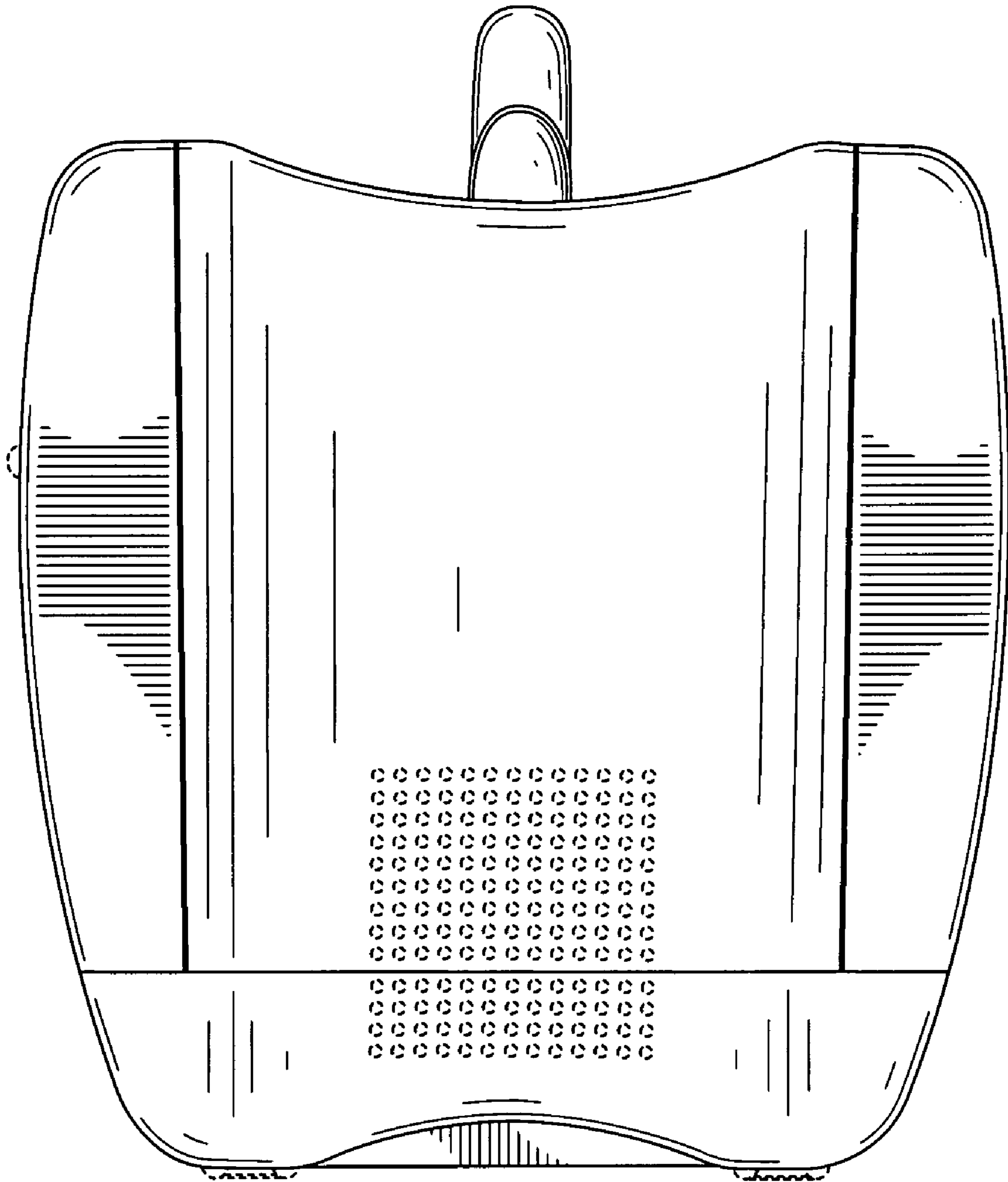

FIG. 6

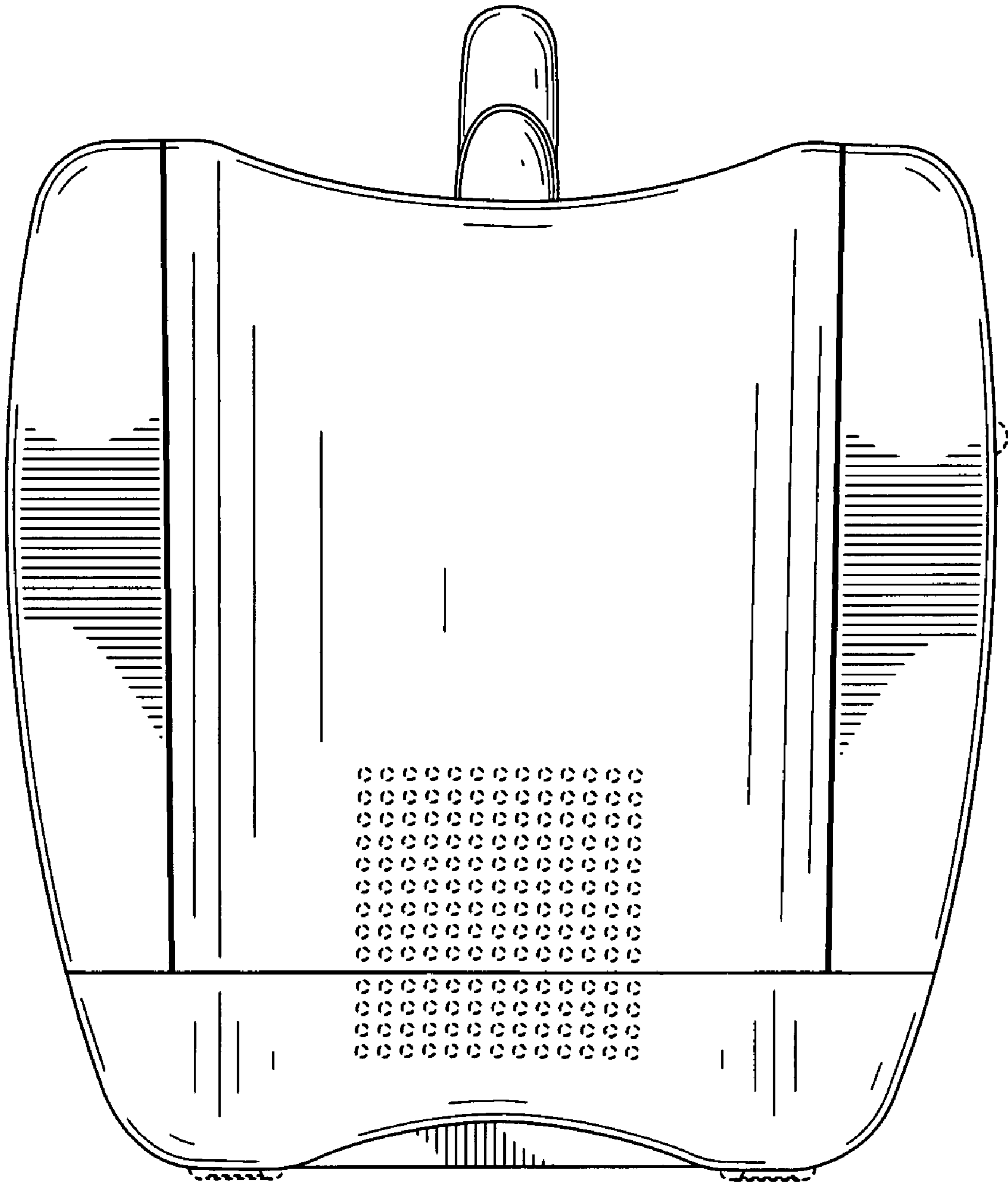

FIG. 7

