

US00D565823S

(12) **United States Design Patent**  
**Hendricks**

(10) **Patent No.:** **US D565,823 S**

(45) **Date of Patent:** **\*\* Apr. 1, 2008**

(54) **DEODORIZING TRASH CAN**

(76) Inventor: **Kevin Hendricks**, 631 Spruce St., Apt.  
L8, Royersford, PA (US) 19468

(\*\*) Term: **14 Years**

(21) Appl. No.: **29/273,736**

(22) Filed: **Mar. 12, 2007**

(51) **LOC (8) Cl.** ..... **09-09**

(52) **U.S. Cl.** ..... **D34/1**

(58) **Field of Classification Search** ..... D34/1,  
D34/4; 220/908-913, 495.04, 495.07  
See application file for complete search history.

(56) **References Cited**

U.S. PATENT DOCUMENTS

4,427,110	A	1/1984	Shaw, Jr.	
D322,498	S *	12/1991	McClees et al.	D34/1
5,108,000	A *	4/1992	Stoll et al.	220/23.4
5,405,041	A *	4/1995	Van Brackle	220/495.07
D376,456	S *	12/1996	Presnell et al.	D34/1
D384,461	S *	9/1997	Kouvdos	D34/1
6,000,571	A	12/1999	Brooks	
6,126,031	A *	10/2000	Reason	220/495.07
D448,133	S *	9/2001	Windle	D34/1
6,554,151	B1	4/2003	Brennan	

D490,581	S *	5/2004	Keithly et al.	D34/1
D493,590	S *	7/2004	Chen	D34/1
D555,317	S *	11/2007	Yang et al.	D34/1
2006/0261072	A1 *	11/2006	Diep	220/495.07

\* cited by examiner

*Primary Examiner*—Cynthia E Ramirez

(57) **CLAIM**

The ornamental design for a deodorizing trash can, as shown and described.

**DESCRIPTION**

FIG. 1 is a rear elevational view of a deodorizing trash can showing my new design;

FIG. 2 is a right side elevational view thereof;

FIG. 3 is a top plan view thereof;

FIG. 4 is a bottom plan elevational;

FIG. 5 is a front elevational view thereof;

FIG. 6 is a left side elevational view showing the deodorizing tray removed from the trash can;

FIG. 7 is a top plan view of FIG. 6; and,

FIG. 8 is a bottom plan view of FIG. 7.

**1 Claim, 8 Drawing Sheets**

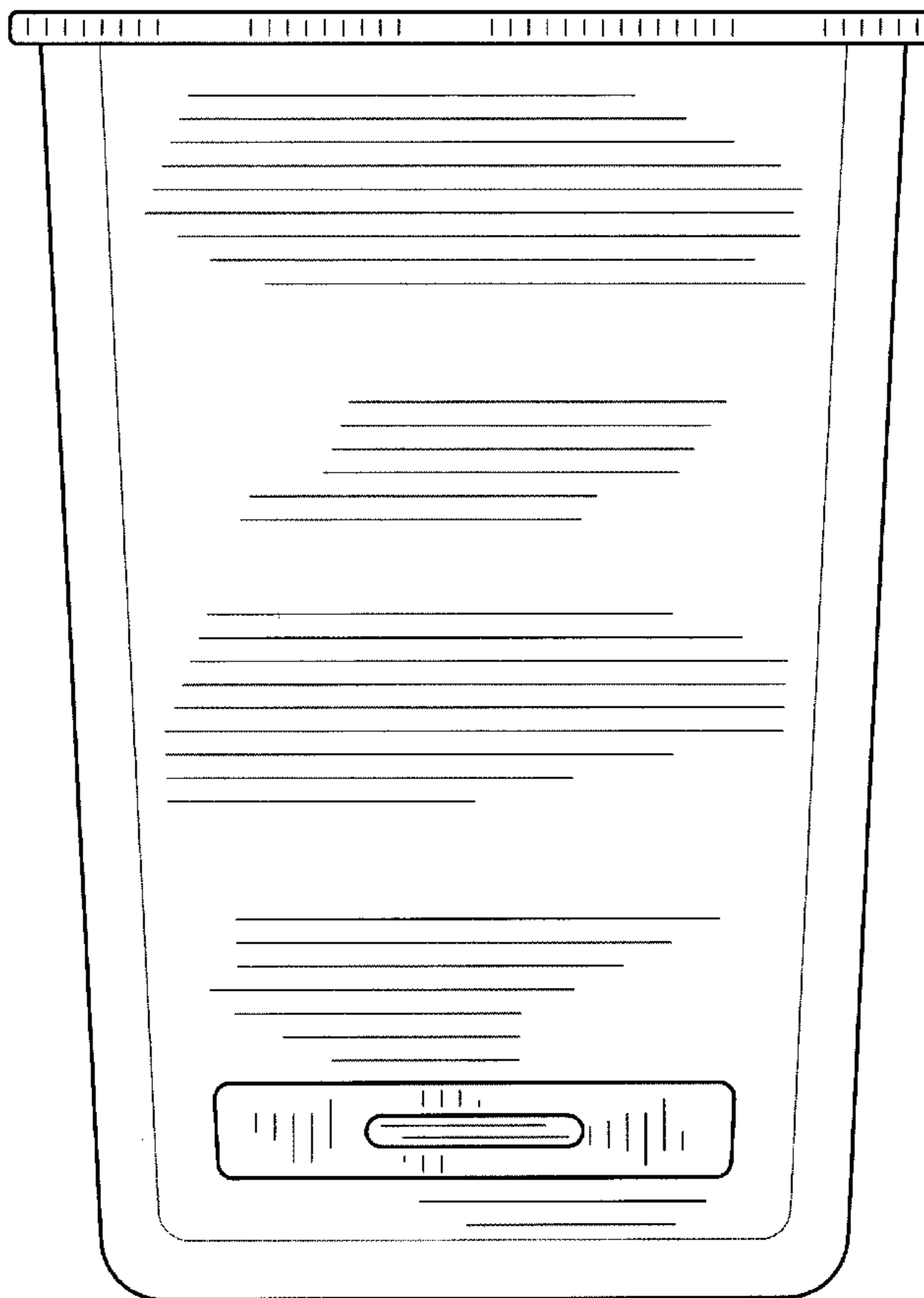

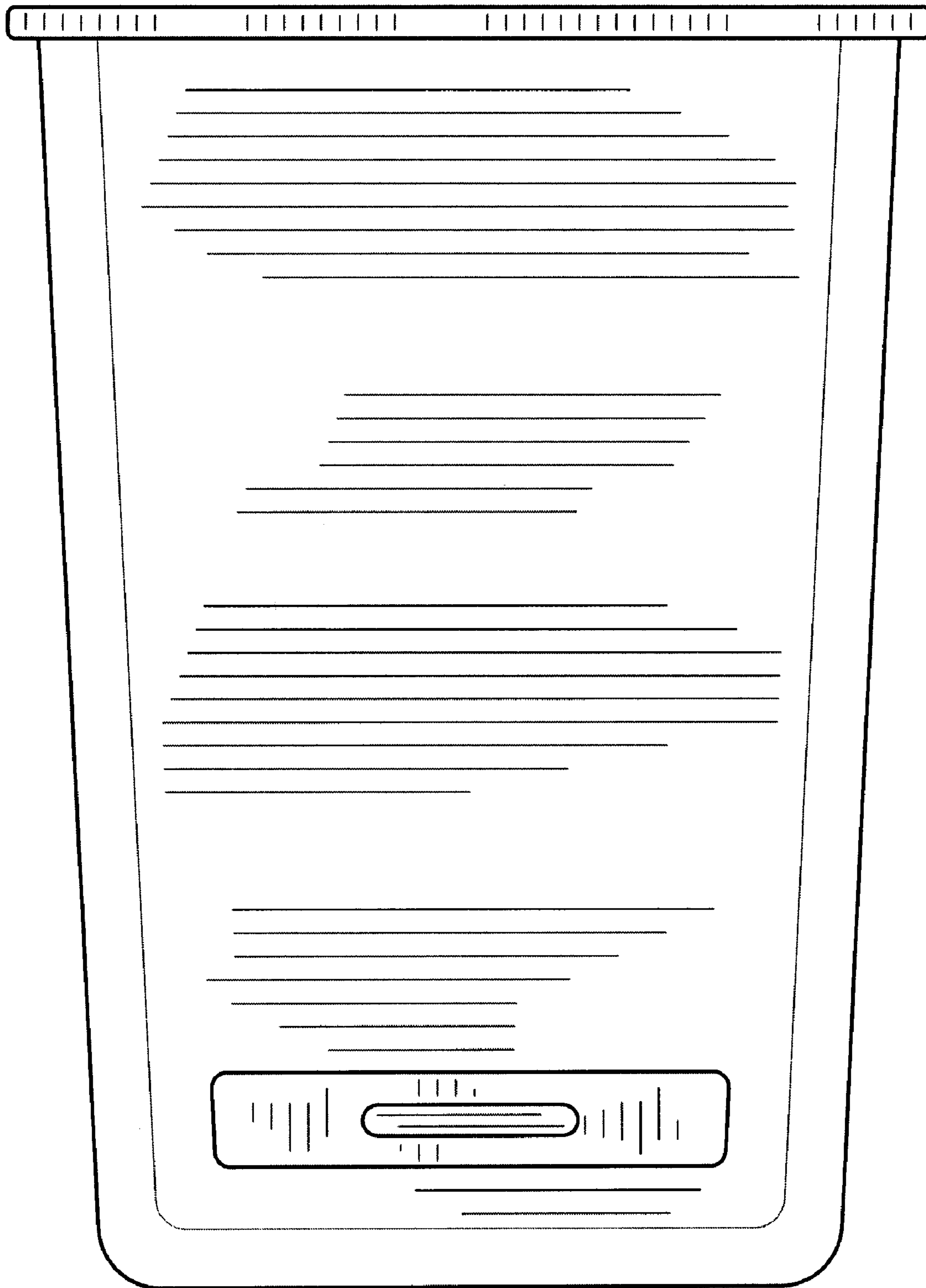

FIG. 1

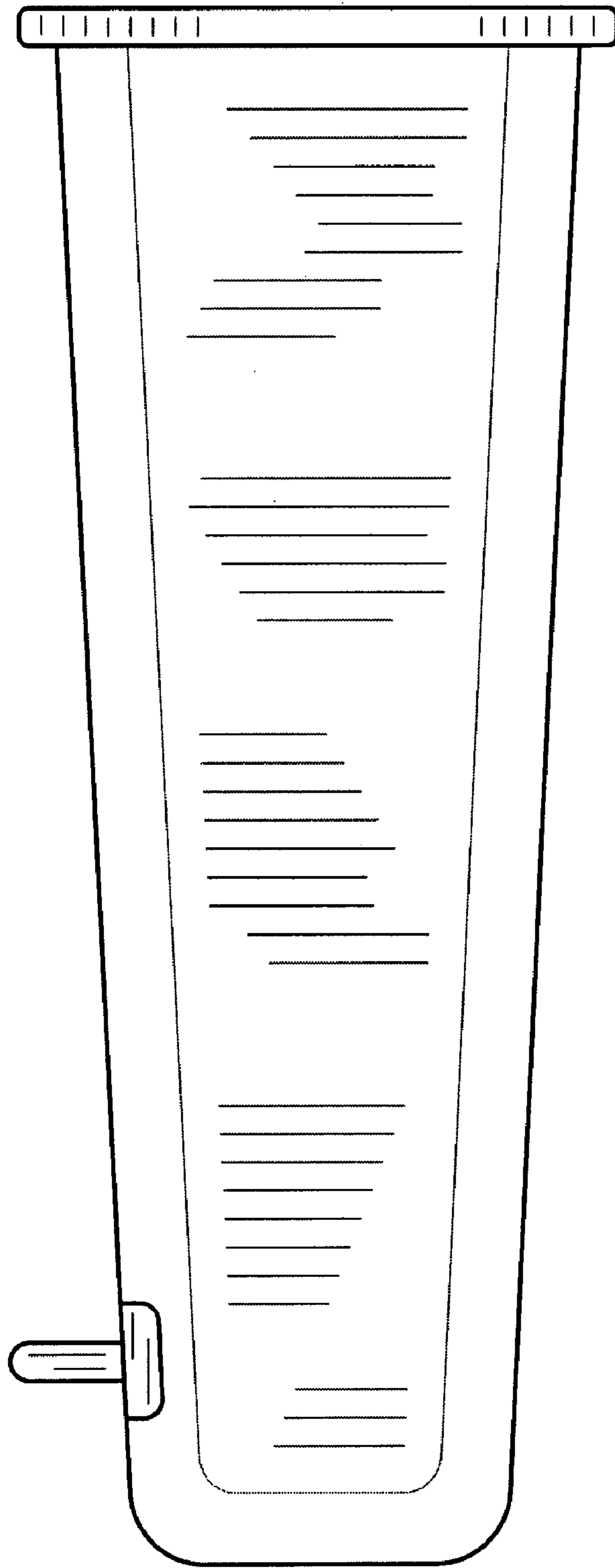

FIG. 2

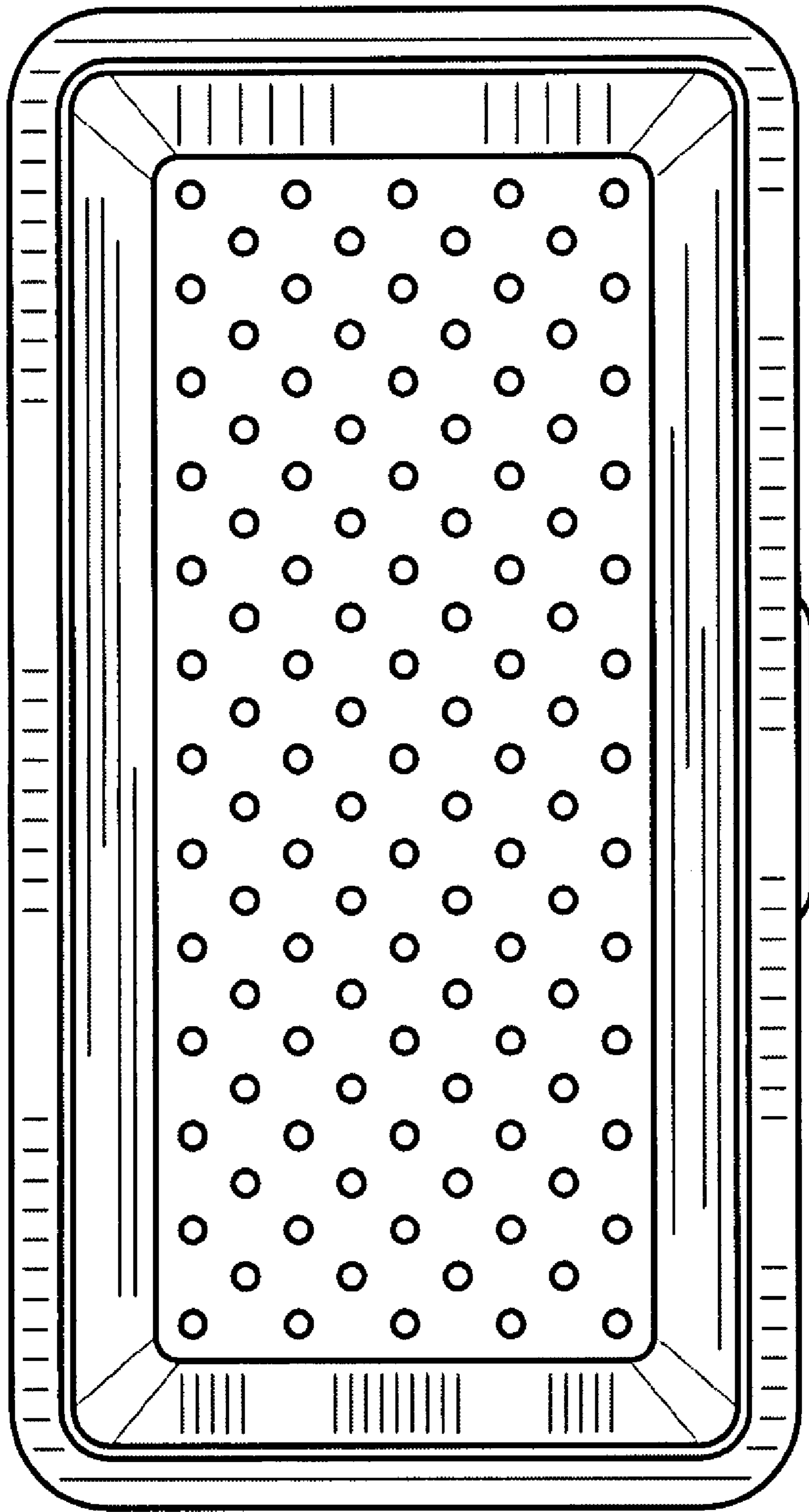

FIG. 3

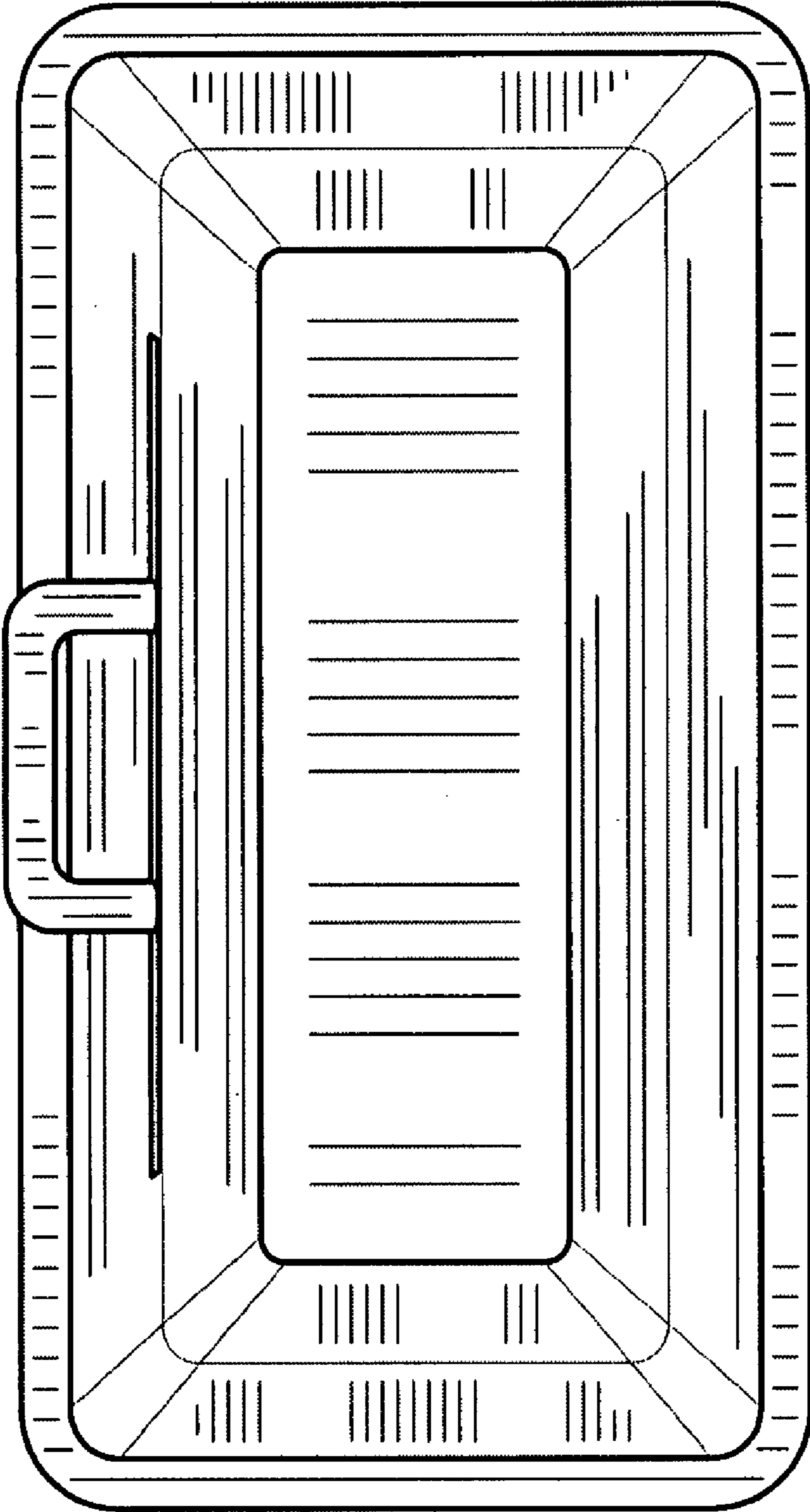

FIG. 4

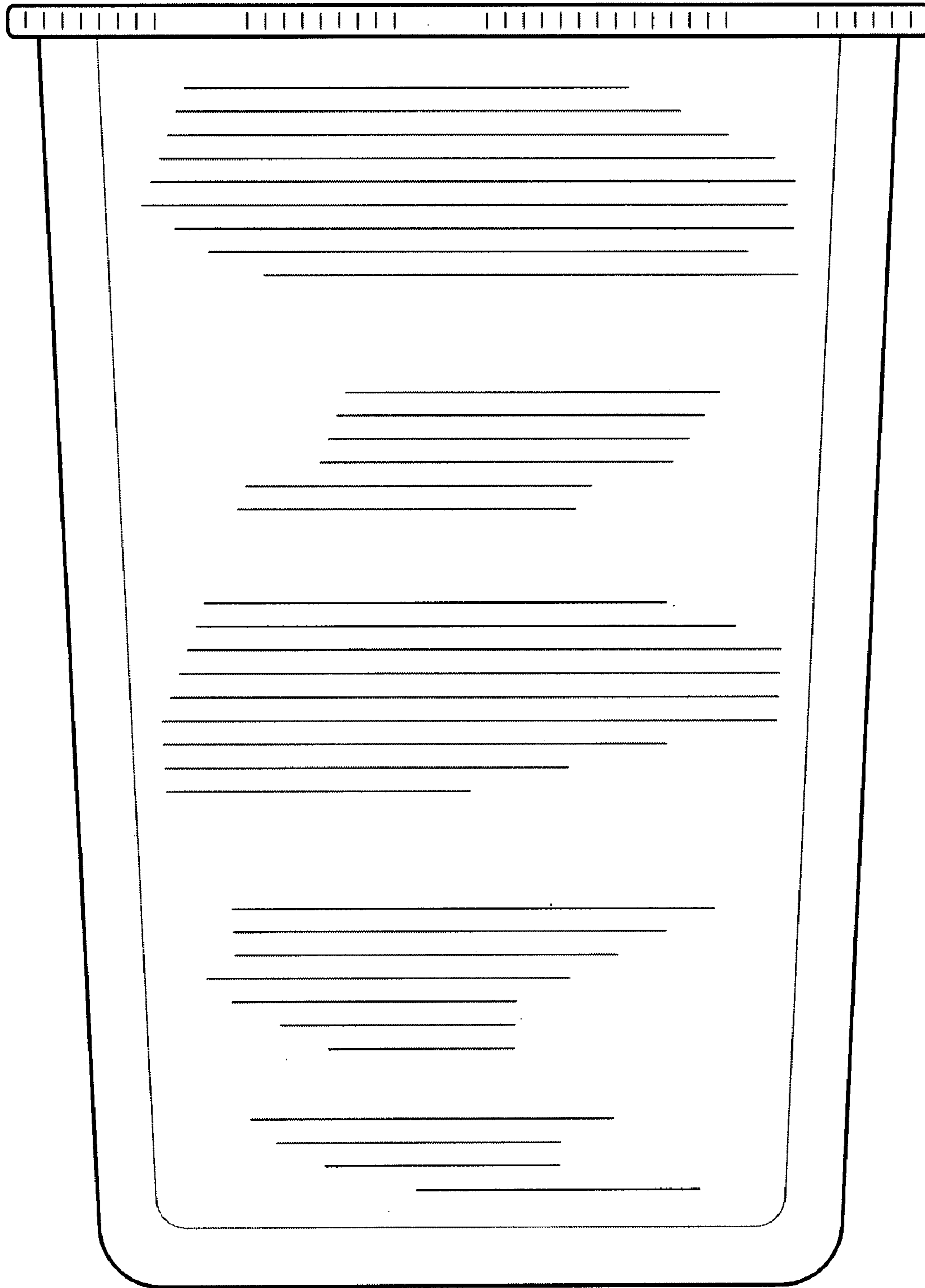

FIG. 5

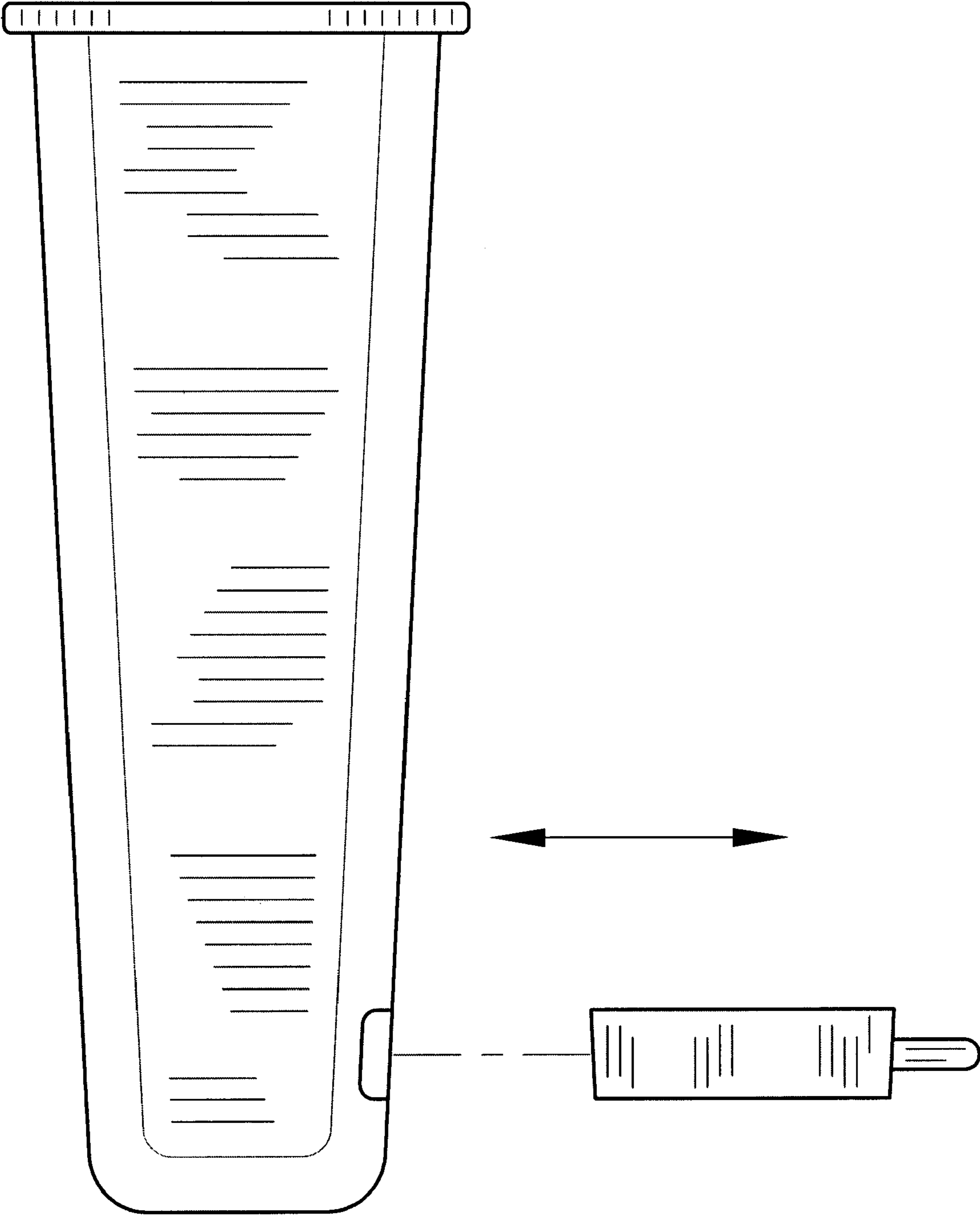

FIG. 6

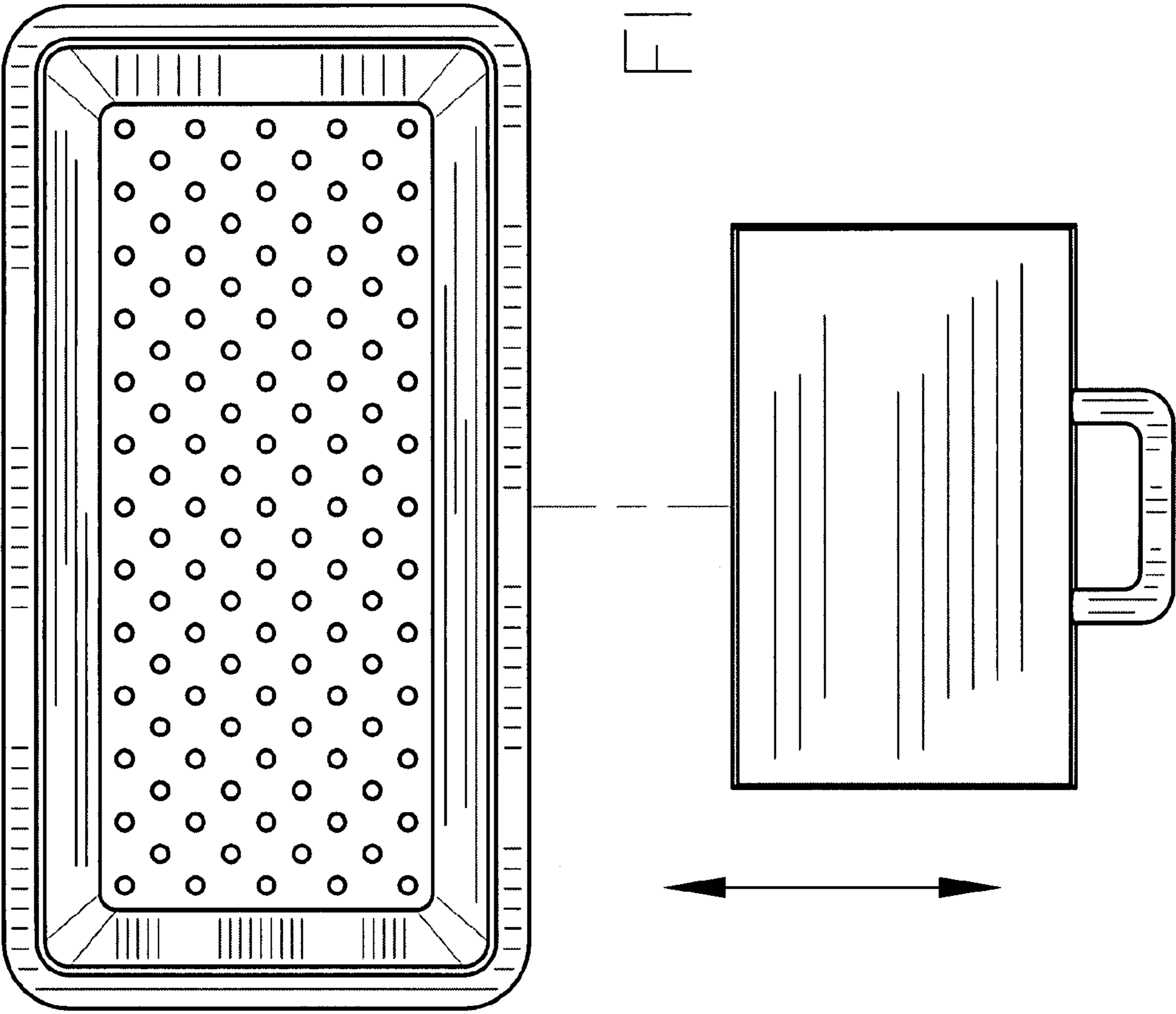

FIG. 7



