



US00D565801S

(12) **United States Design Patent**
Curci et al.

(10) **Patent No.:** **US D565,801 S**

(45) **Date of Patent:** **** Apr. 1, 2008**

(54) **BLADE WELDING HELMET**

(75) Inventors: **Raymond Curci**, Smithfield, RI (US);
Jason Gleason, West Greenwich, RI
(US); **Joe Falvo**, Johnston, RI (US);
Fred Edgar, Rochester, MA (US);
Artiss Akarra, Providence, RI (US)

(73) Assignee: **Sperian Eye & Face Protection, Inc.**,
Smithfield, RI (US)

(**) Term: **14 Years**

(21) Appl. No.: **29/278,612**

(22) Filed: **Apr. 4, 2007**

(51) **LOC (8) Cl.** **29-02**

(52) **U.S. Cl.** **D29/110**

(58) **Field of Classification Search** D2/865,
D2/878, 891, 501; 2/9, 171-173, 202-206,
2/209.13, 5, 6.1, 6.3, 6.5-6.7, 410-412, 414,
2/416-418, 421-425, 455, 8.1-8.5, 8.7, 8.8,
2/175.6; D29/102, 105, 106, 108, 110, 122;
D24/191; 128/857, 858, 859, 863, 201.24

See application file for complete search history.

(56) **References Cited**

U.S. PATENT DOCUMENTS

1,795,866 A	3/1931	King	
3,444,561 A	5/1969	Boyer	
4,774,723 A	10/1988	Ruck	
5,062,156 A	11/1991	Siegal	
5,533,206 A	7/1996	Petrie et al.	
5,548,448 A	8/1996	Wagner	
D393,933 S *	4/1998	Huh	D29/110
D394,732 S *	5/1998	Huh	D29/110
D398,421 S *	9/1998	Crafoord et al.	D29/110
5,857,215 A *	1/1999	Ferguson et al.	2/8.3
6,151,711 A	11/2000	Edwards	
6,401,244 B1	6/2002	Kramer et al.	

6,557,174 B2	5/2003	Martin et al.	
D482,502 S *	11/2003	Huh	D29/110
6,934,967 B2	8/2005	Miyashita et al.	
6,973,672 B2	12/2005	Huh	
D524,991 S *	7/2006	Martin et al.	D29/110
D527,849 S *	9/2006	Huh	D29/110
D530,864 S *	10/2006	Huh	D29/110
D540,989 S *	4/2007	Huh	D29/110
D540,990 S *	4/2007	Huh	D29/110
D553,802 S *	10/2007	Huh	D29/110

* cited by examiner

Primary Examiner—Ruth McInroy

(74) *Attorney, Agent, or Firm*—Barlow, Josephs & Holmes,
Ltd.

(57) **CLAIM**

The ornamental design for a blade welding helmet, as shown
and described.

DESCRIPTION

FIG. 1 is a front perspective view of the blade welding helmet
in accordance with the present invention, the dashed lines
forming no part of the claimed design;

FIG. 2 is a front view thereof, the dashed lines forming no
part of the claimed design;

FIG. 3 is a rear view thereof, the dashed lines forming no
part of the claimed design;

FIG. 4 is a left view thereof, the dashed lines forming no part
of the claimed design;

FIG. 5 is a right view thereof, the dashed lines forming no
part of the claimed design;

FIG. 6 is a top view thereof, the dashed lines forming no part
of the claimed design; and,

FIG. 7 is bottom view thereof, the dashed lines forming no
part of the claimed design.

1 Claim, 7 Drawing Sheets

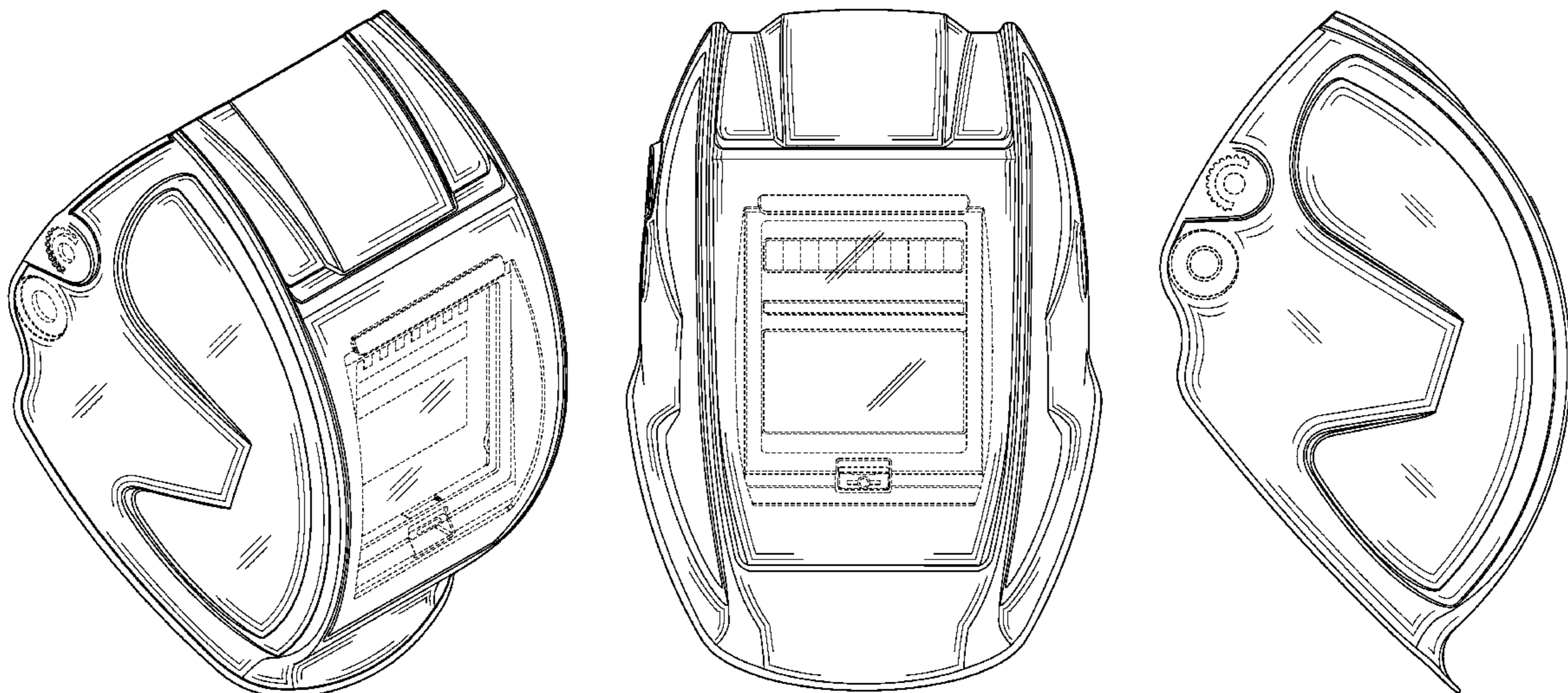

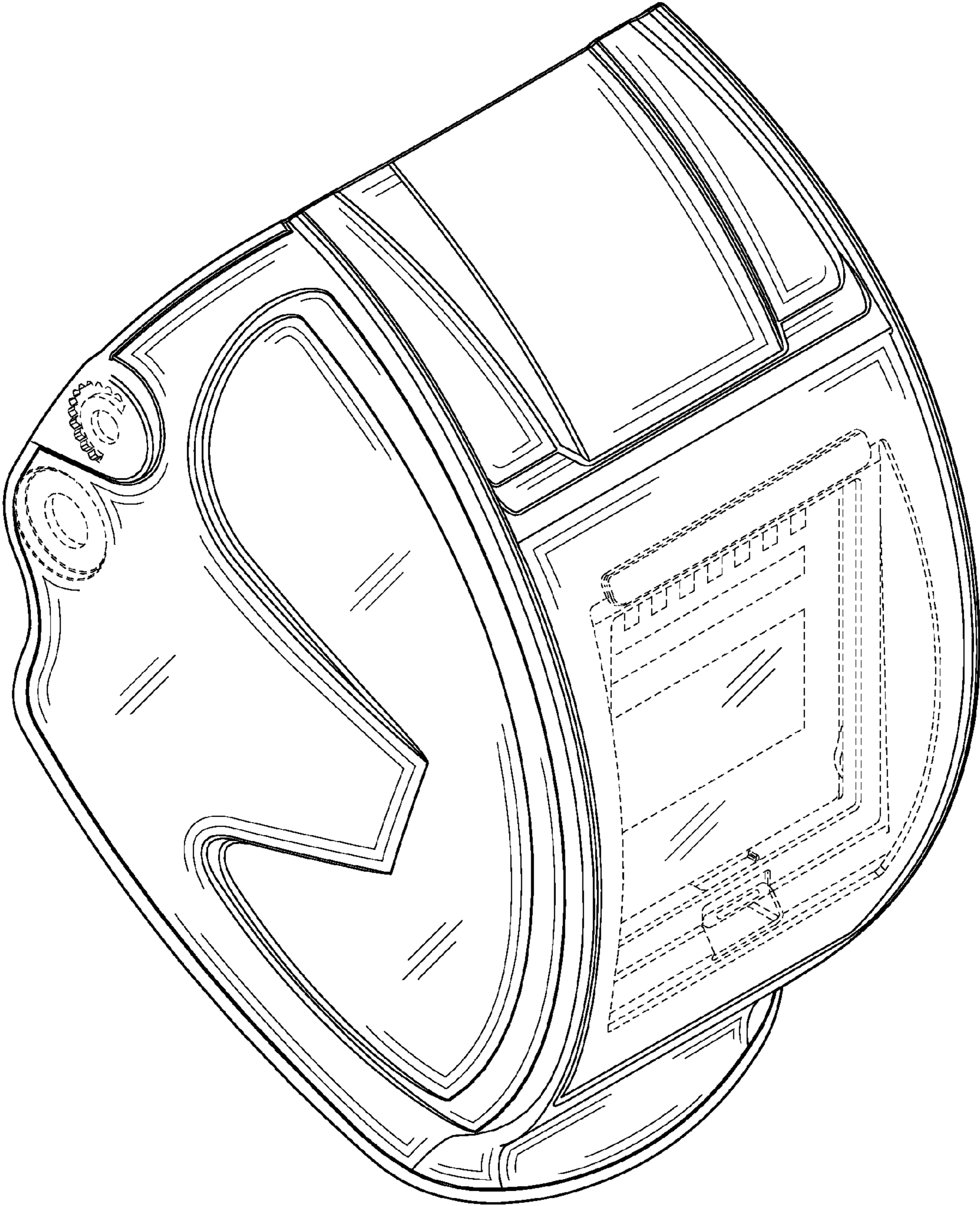

Fig. 1

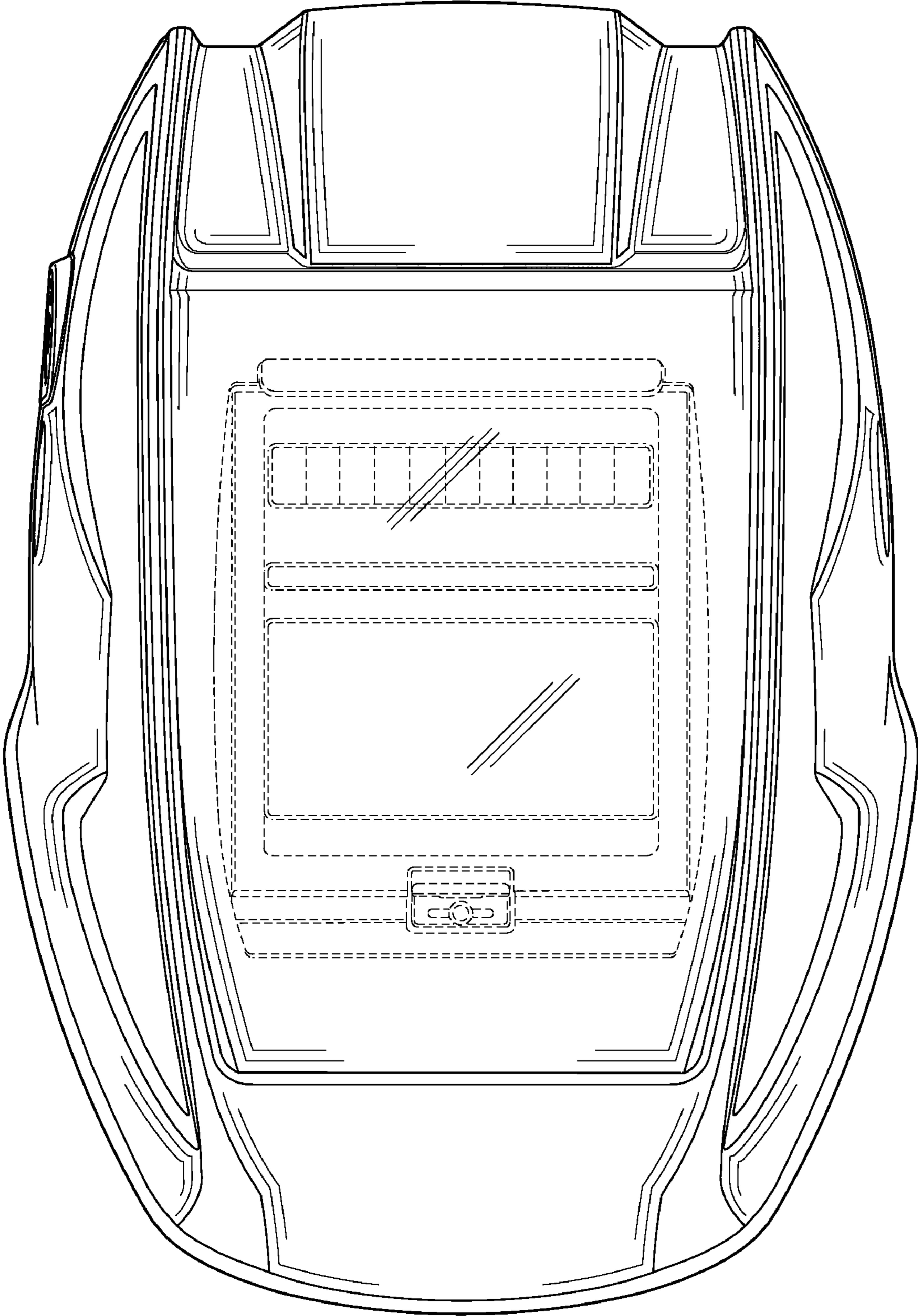

Fig. 2

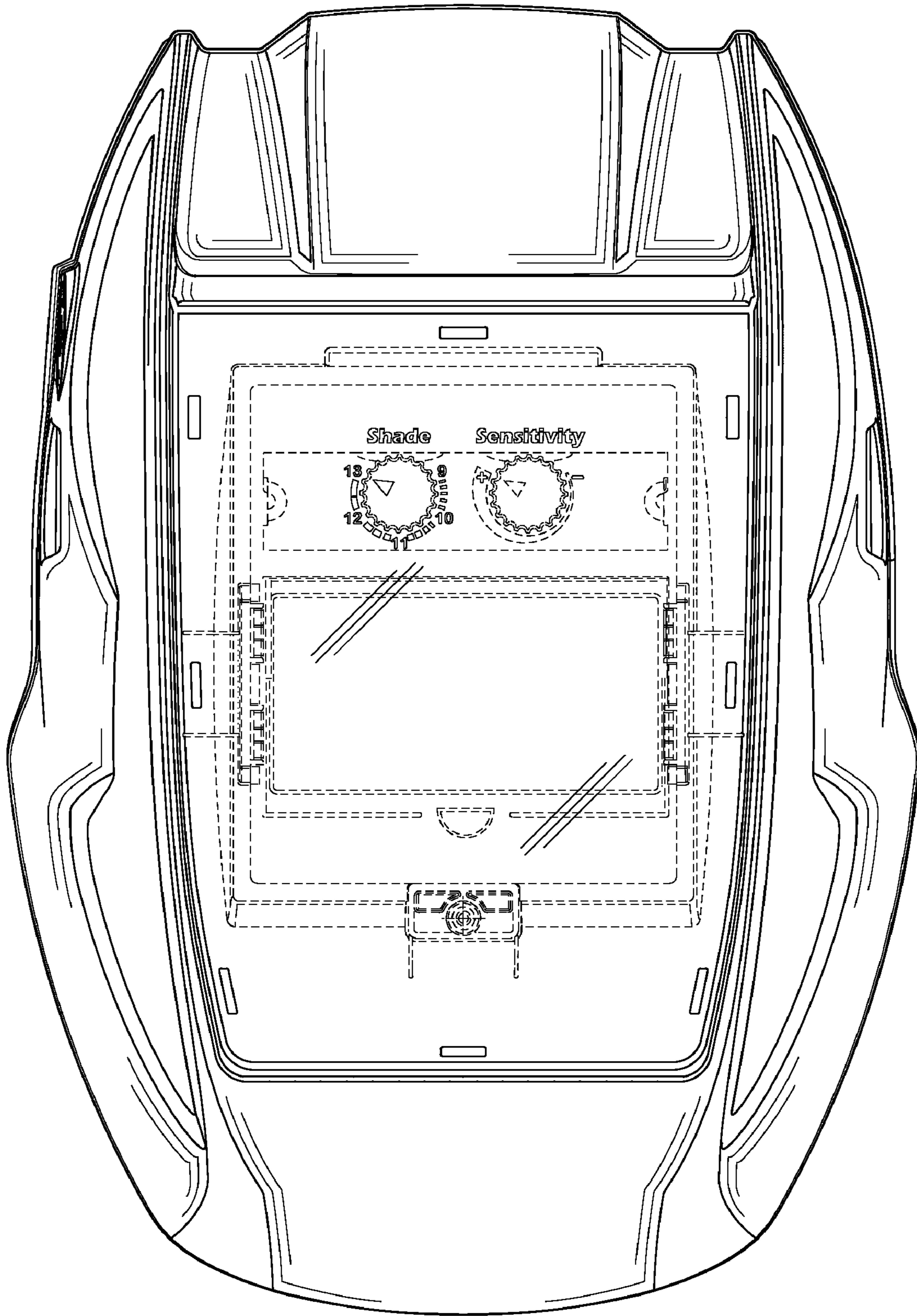

Fig. 3

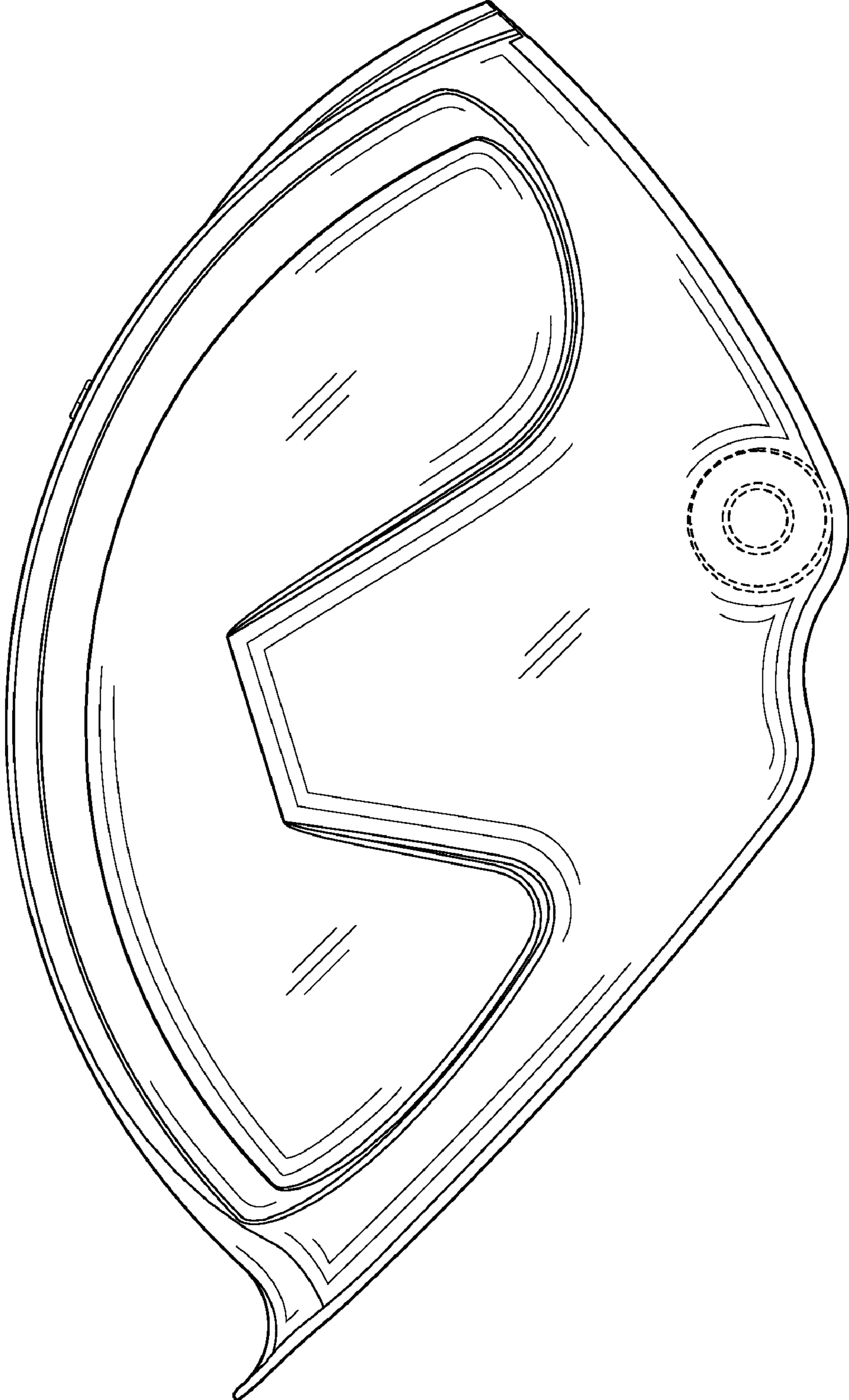

Fig. 4

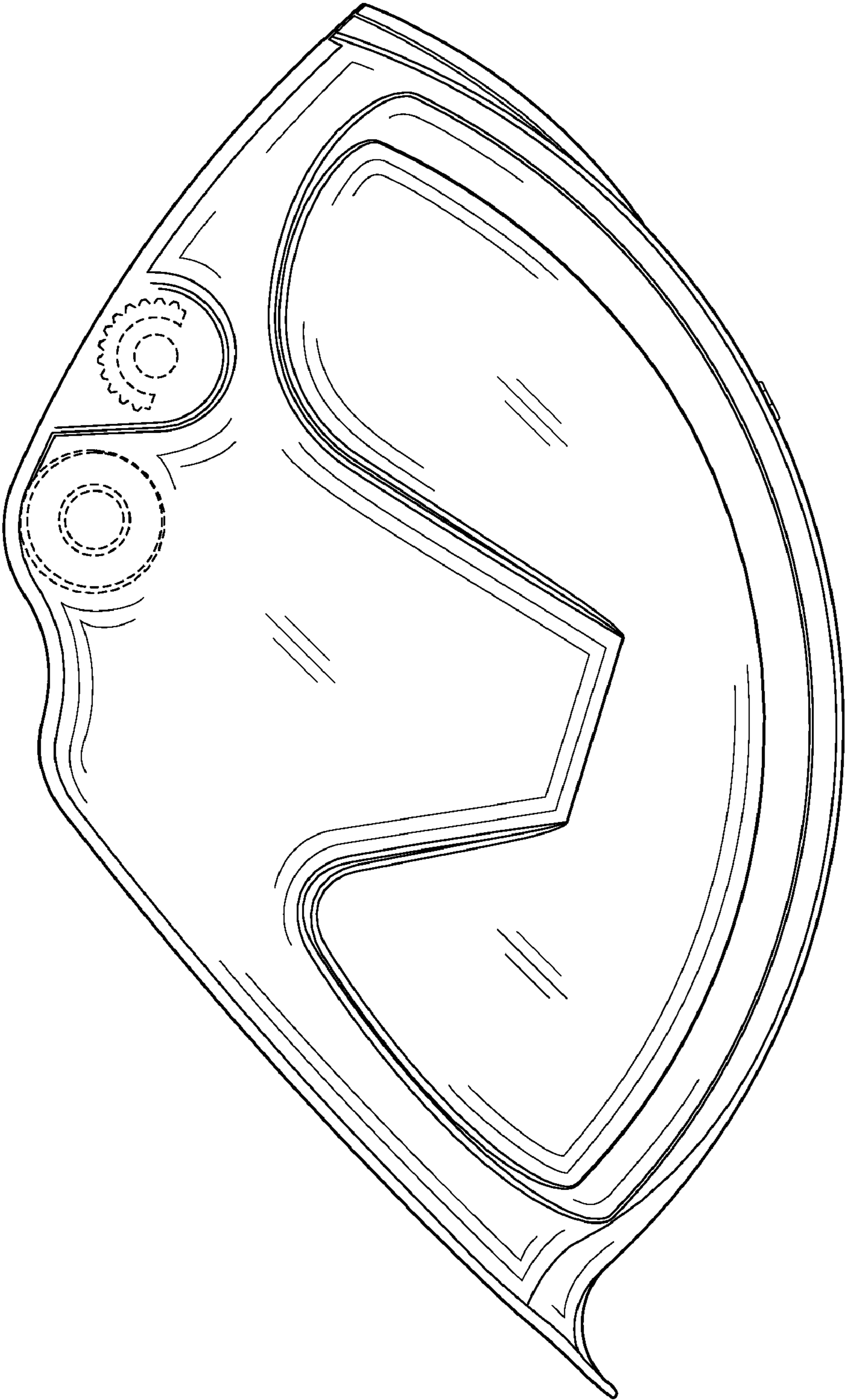

Fig. 5

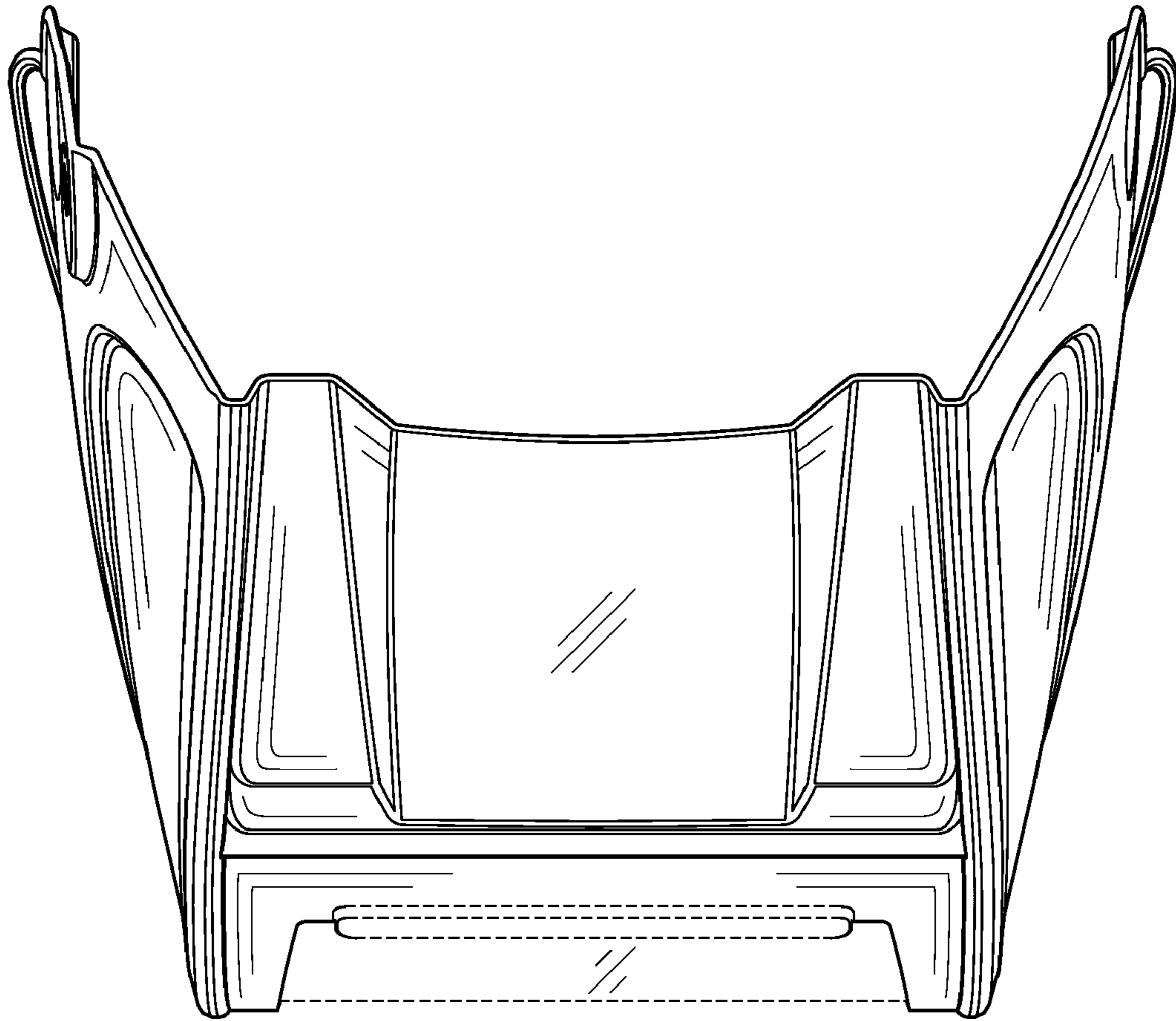

Fig. 6

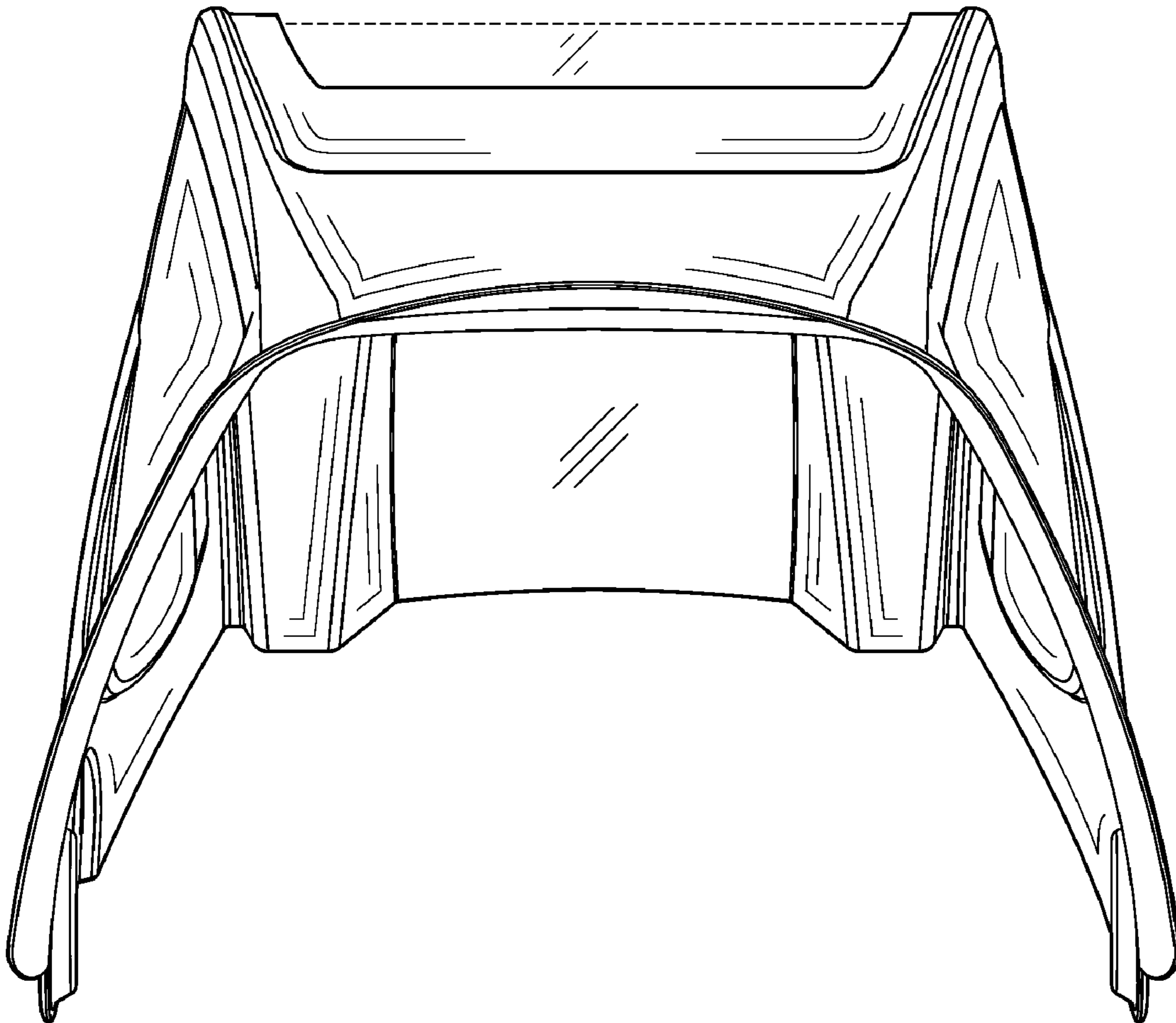

Fig. 7