



US00D565800S

(12) **United States Design Patent**
Wang

(10) **Patent No.:** **US D565,800 S**

(45) **Date of Patent:** **** Apr. 1, 2008**

(54) **WELDING HELMET**

(76) Inventor: **Jisheng Wang**, RM 102 Block F, Aotai Resort, Taian, Shandong Province (CN)

(**) Term: **14 Years**

(21) Appl. No.: **29/269,605**

(22) Filed: **Dec. 5, 2006**

(51) **LOC (8) Cl.** **29-02**

(52) **U.S. Cl.** **D29/110**

(58) **Field of Classification Search** D2/865, D2/878, 891, 501; 2/9, 171-173, 202-206, 2/209.13, 5, 6.1, 6.3, 6.5-6.7, 410-412, 414, 2/416-418, 421-425, 455, 8.1-8.5, 8.7, 8.8, 2/175.6; D29/102, 105, 106, 108, 110, 122; D24/191; 128/857, 858, 859, 863, 201.24
See application file for complete search history.

(56) **References Cited**

U.S. PATENT DOCUMENTS

D393,933	S	*	4/1998	Huh	D29/110
D394,732	S	*	5/1998	Huh	D29/110
D398,421	S	*	9/1998	Crafoord et al.	D29/110
5,857,215	A	*	1/1999	Ferguson et al.	2/8.3
D482,502	S	*	11/2003	Huh	D29/110
D524,991	S	*	7/2006	Martin et al.	D29/110

D527,849	S	*	9/2006	Huh	D29/110
D530,864	S	*	10/2006	Huh	D29/110
D540,989	S	*	4/2007	Huh	D29/110
D540,990	S	*	4/2007	Huh	D29/110
D553,802	S	*	10/2007	Huh	D29/110

* cited by examiner

Primary Examiner—Ruth McInroy

(74) *Attorney, Agent, or Firm*—Manelli Denison & Selter PLLC; Edward J. Stemberger

(57) **CLAIM**

The ornamental design for a welding helmet, as shown and described.

DESCRIPTION

FIG. 1 is a front view of a welding helmet showing my new design;

FIG. 2 is a bottom view thereof;

FIG. 3 is a left side view thereof;

FIG. 4 is a right side view thereof;

FIG. 5 is a top view thereof;

FIG. 6 is a rear view thereof; and,

FIG. 7 is a perspective view thereof.

1 Claim, 7 Drawing Sheets

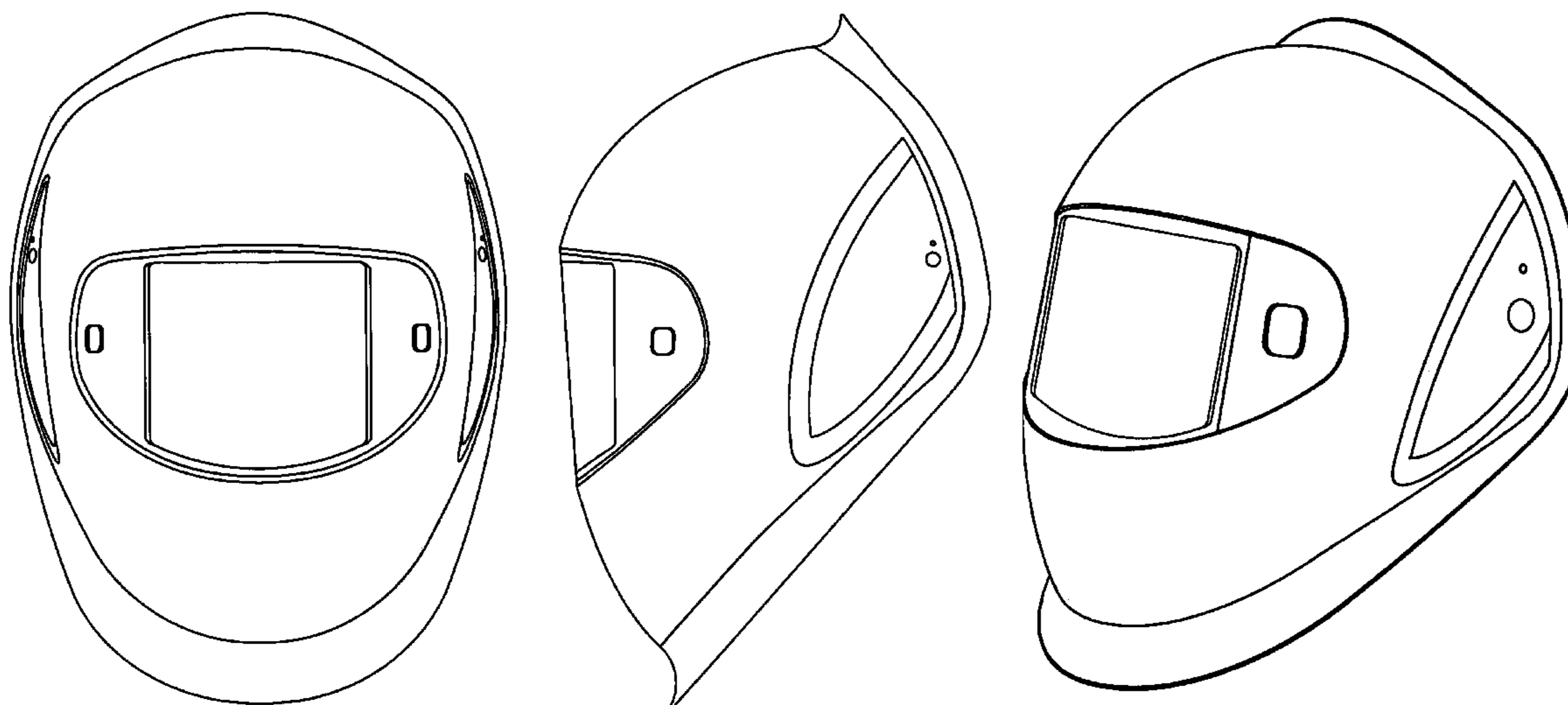

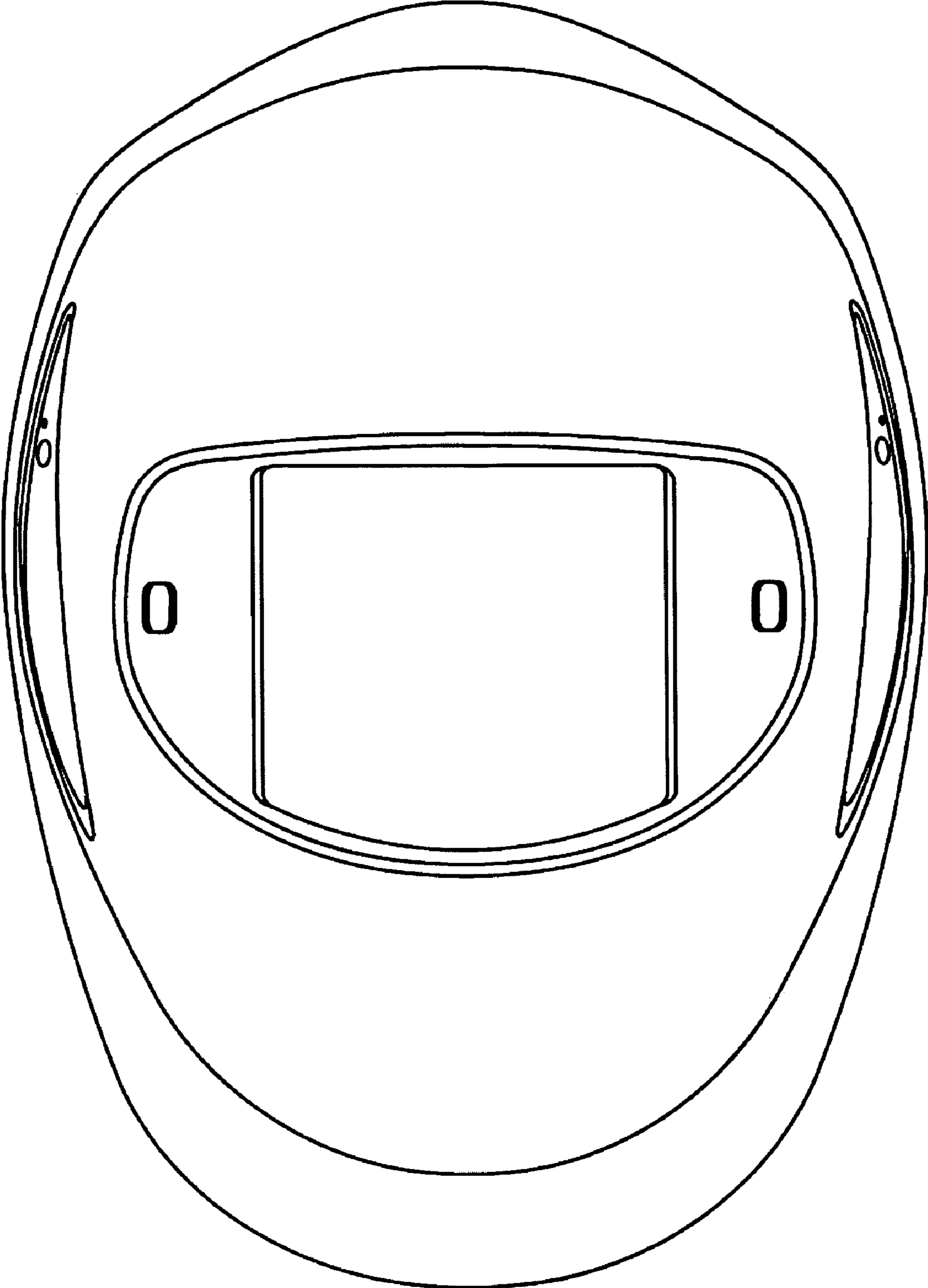

Fig.1

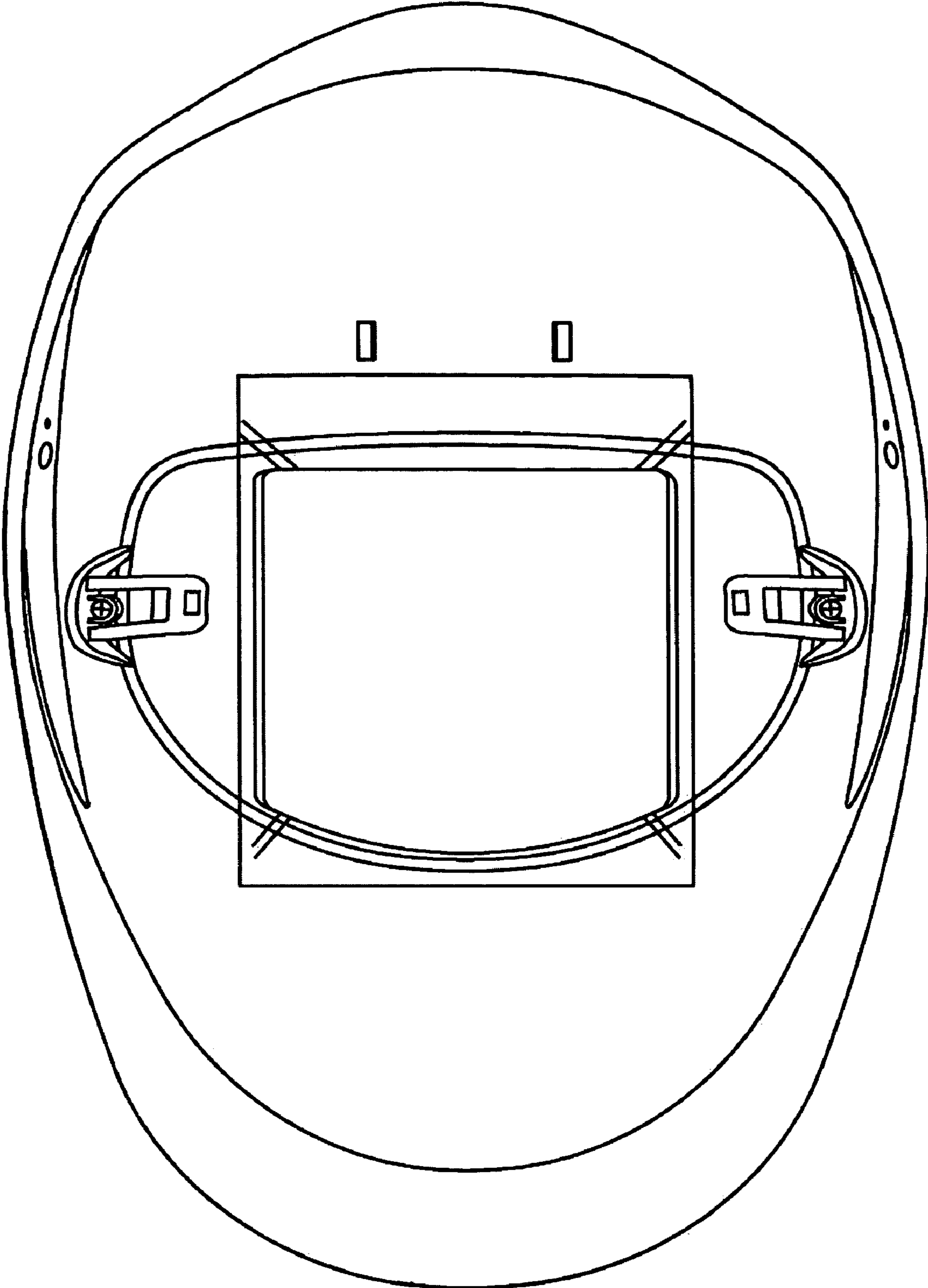

Fig.2

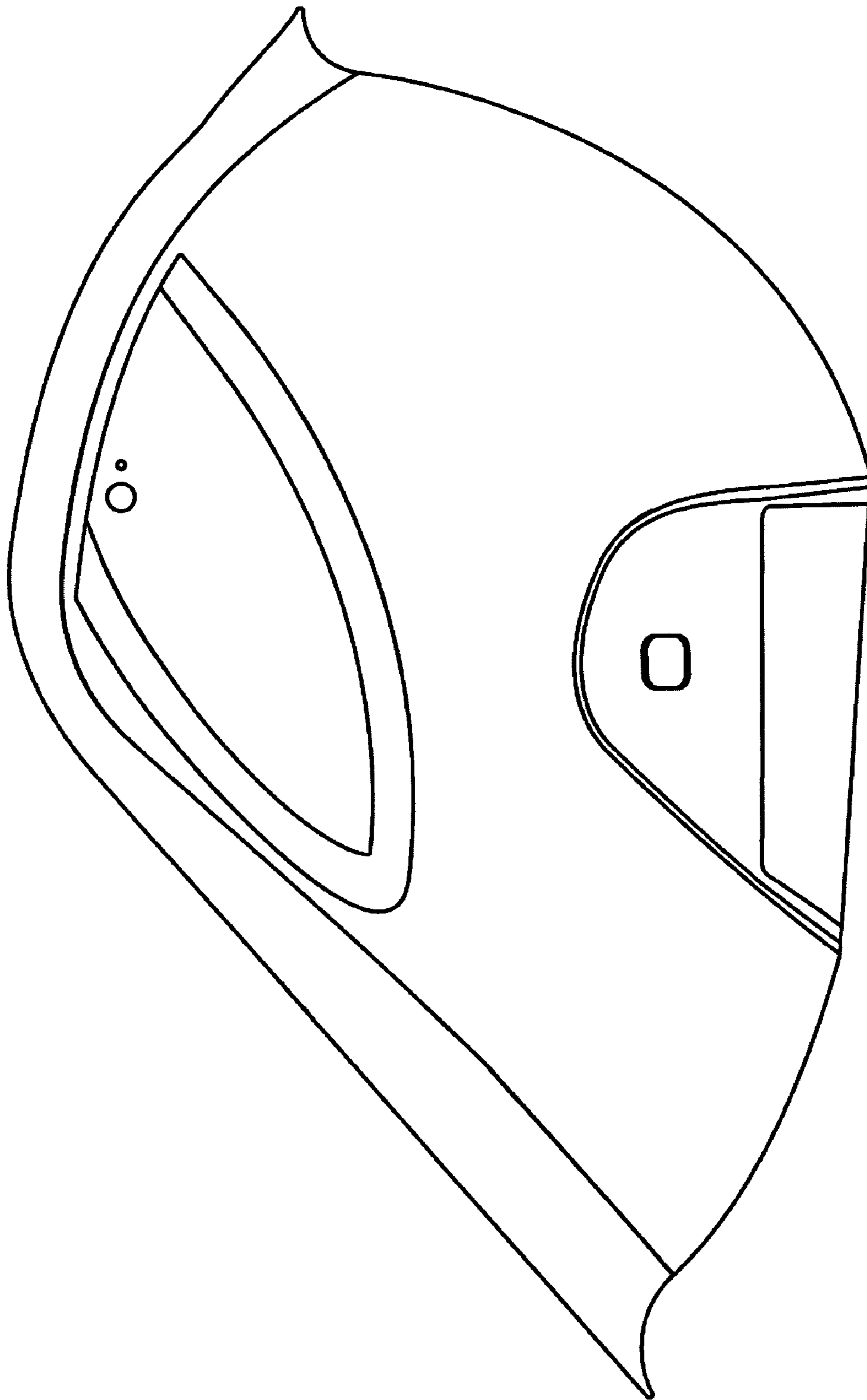

Fig.3

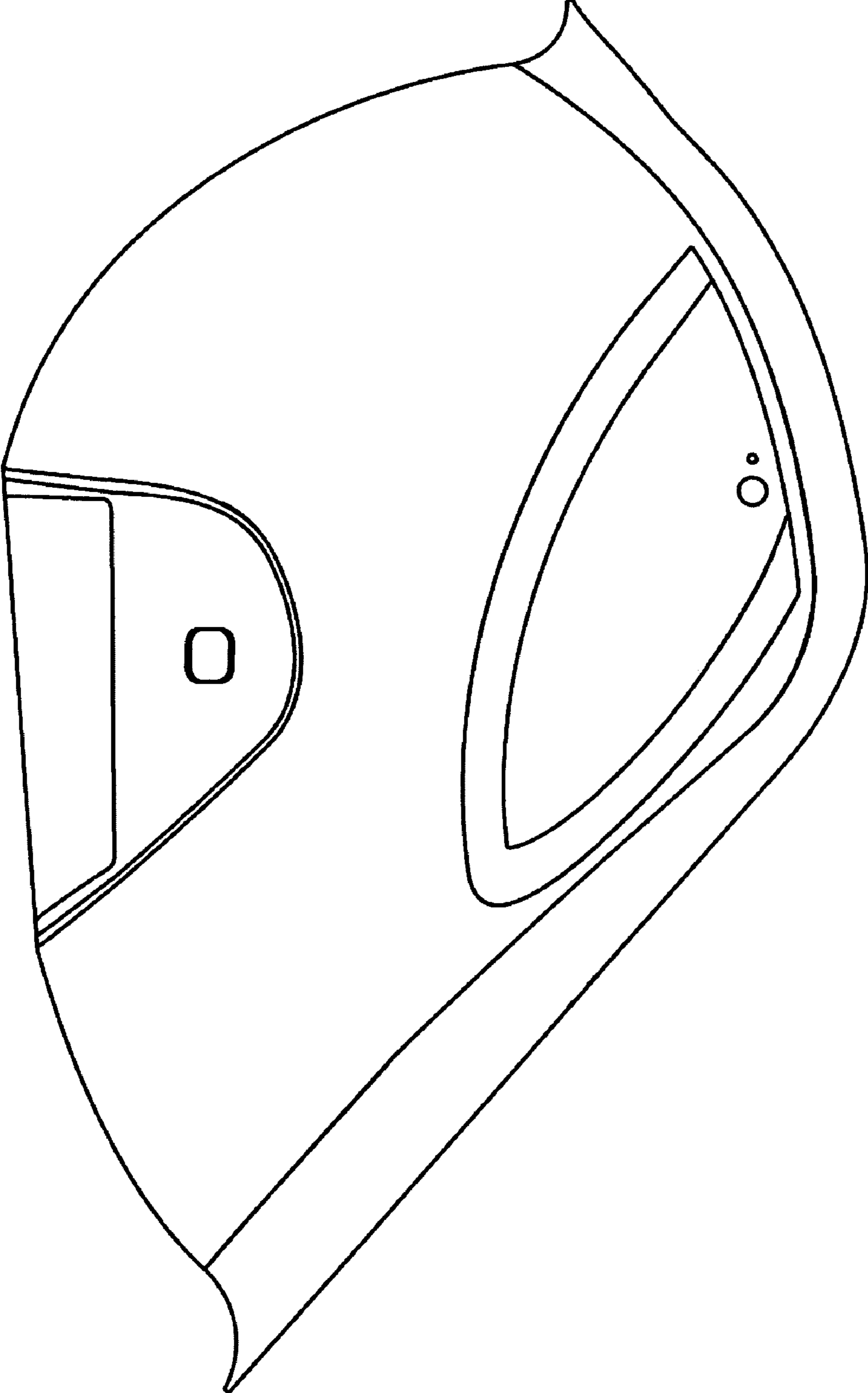

Fig.4

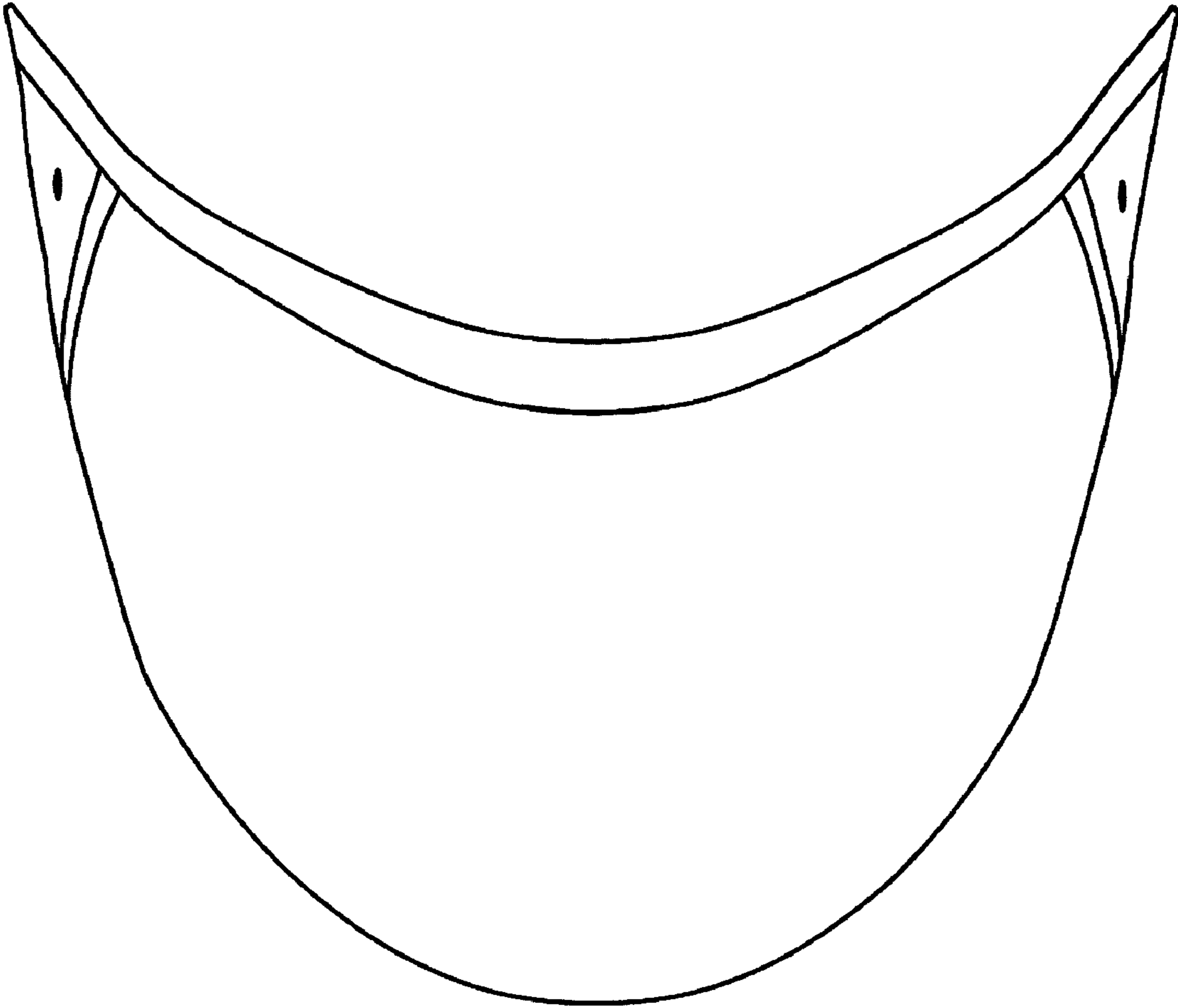

Fig.5

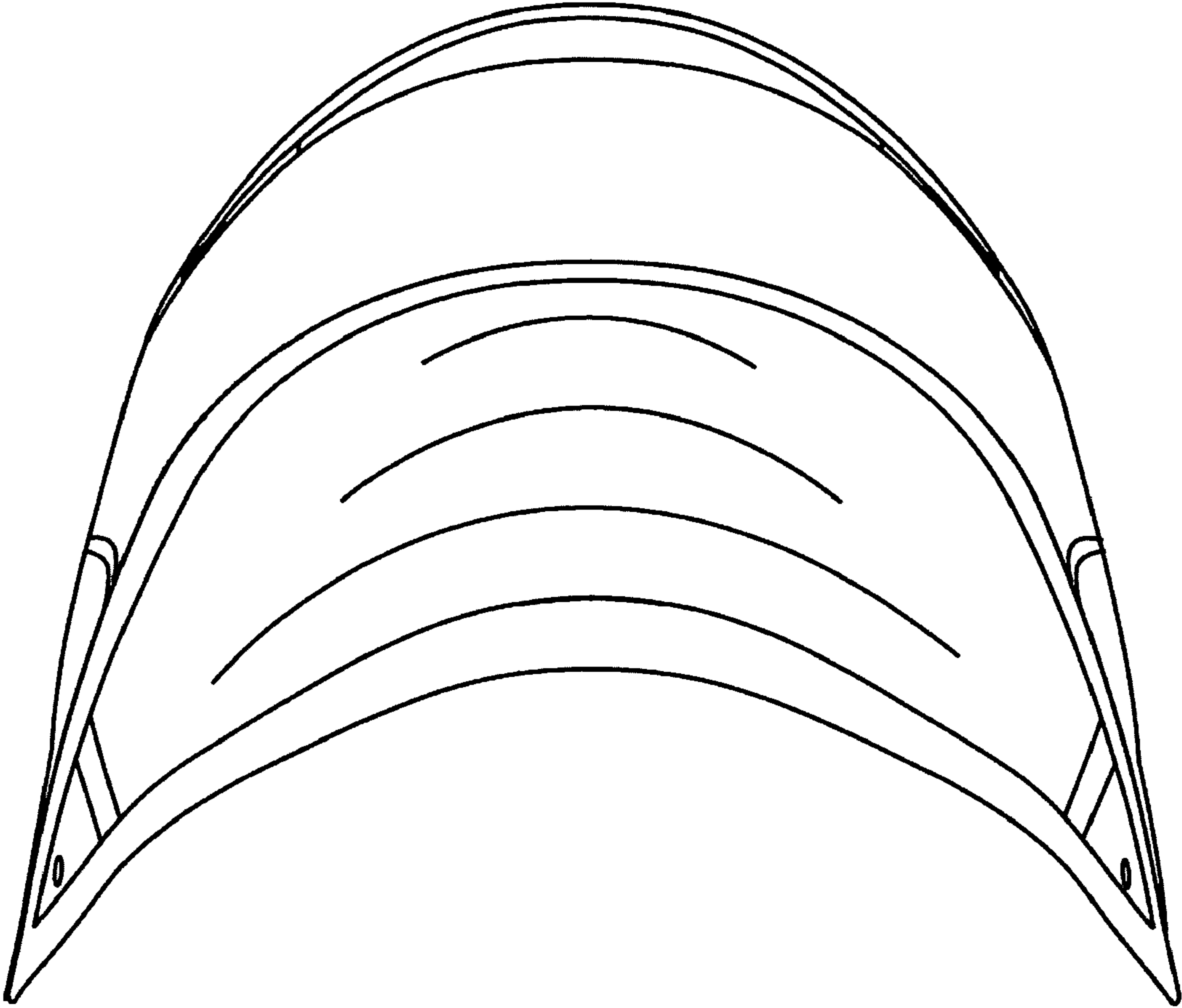

Fig.6

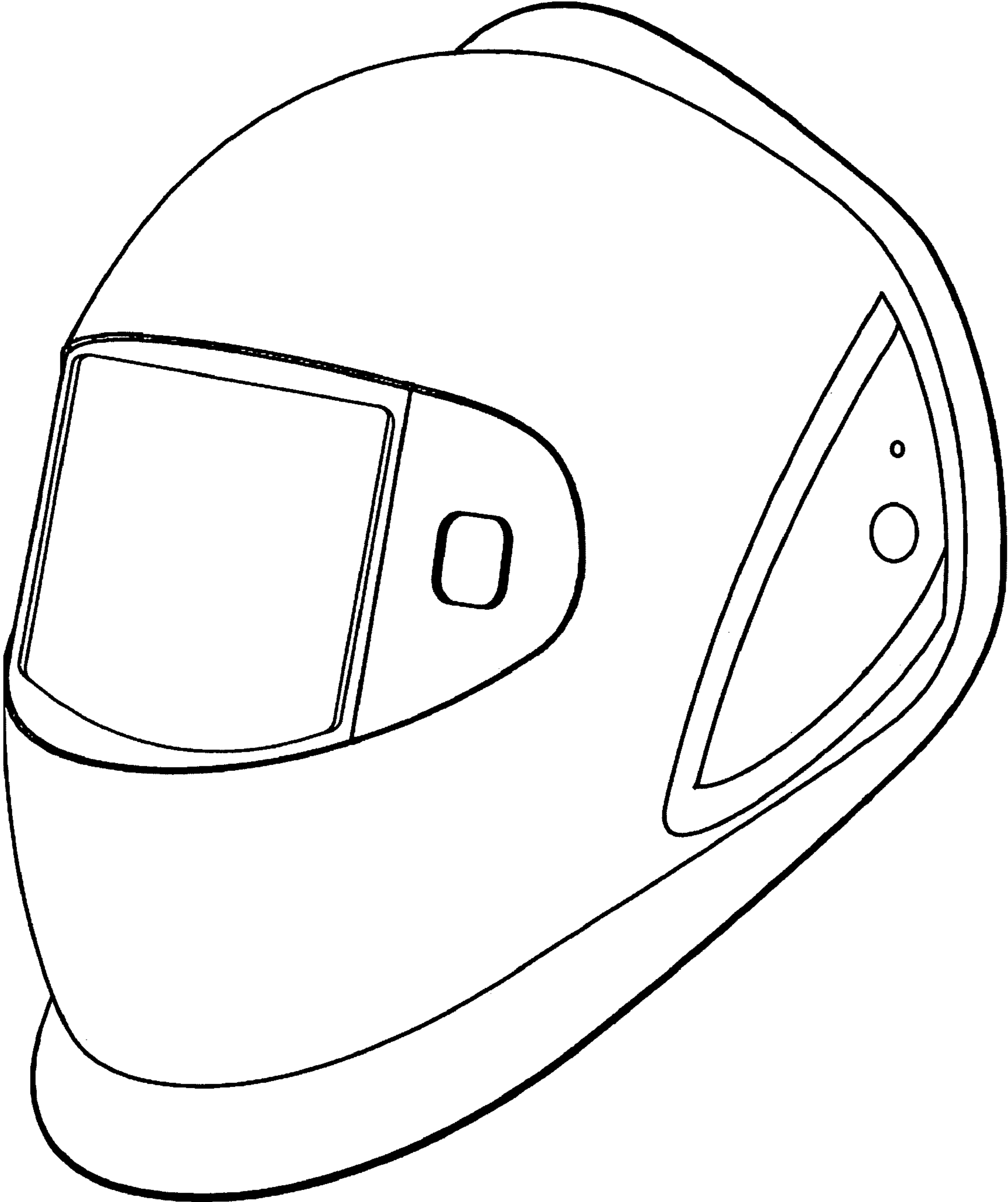

Fig.7