



US00D565650S

(12) **United States Design Patent**
Tani

(10) **Patent No.:** **US D565,650 S**

(45) **Date of Patent:** **** Apr. 1, 2008**

(54) **MULTI-FUNCTION PRINTER**

(75) Inventor: **Atsushi Tani**, Kadoma (JP)

(73) Assignee: **Matsushita Electric Industrial Co., Ltd.**, Osaka (JP)

(**) Term: **14 Years**

(21) Appl. No.: **29/288,735**

(22) Filed: **Jun. 21, 2007**

D502,500 S	3/2005	Hoshiya et al.	
D516,081 S	2/2006	Takimoto	
D520,054 S *	5/2006	Katayama et al.	D18/54
D526,351 S	8/2006	Yamamoto et al.	
D528,154 S *	9/2006	Hattori	D18/54
D528,155 S	9/2006	Katayama	
D528,596 S *	9/2006	Hattori	D18/54
D529,951 S	10/2006	Katayama et al.	
D530,737 S *	10/2006	Lim et al.	D18/50
D534,175 S *	12/2006	Orihashi et al.	D14/463
D536,372 S *	2/2007	Lim et al.	D18/53

Related U.S. Application Data

(62) Division of application No. 29/270,468, filed on Dec. 22, 2006, now Pat. No. Des. 550,279.

(51) **LOC (8) Cl.** **18-02**

(52) **U.S. Cl.** **D18/50**

(58) **Field of Classification Search** D18/50,
D18/52, 53, 54, 56, 14, 18, 19; D14/399,
D14/463, 464; D13/164, 168; 400/613,
400/613.1-613.4, 691-694; 101/93.4, 269;
355/78

See application file for complete search history.

References Cited

U.S. PATENT DOCUMENTS

D267,948 S	2/1983	Kojima et al.	
D304,186 S *	10/1989	Kojima	D14/464
D313,798 S	1/1991	Morozumi	
D329,870 S	9/1992	Hanasaki et al.	
D331,069 S	11/1992	Hanasaki et al.	
D344,939 S	3/1994	Kashiwabara et al.	
D428,049 S	7/2000	Imai	
D450,709 S *	11/2001	Nakamura	D14/463
D468,321 S *	1/2003	Naganuma	D14/463
D491,219 S	6/2004	Shimamura	

FOREIGN PATENT DOCUMENTS

GB 2053025 * 4/1996

* cited by examiner

Primary Examiner—Charles A. Rademaker

(74) *Attorney, Agent, or Firm*—Brinks Hofer Gilson & Lione

(57) **CLAIM**

I claim the ornamental design for a multi-function printer, as shown and described.

DESCRIPTION

FIG. 1 is a front perspective view of a multi-function printer showing my new design:

FIG. 2 is a front view thereof;

FIG. 3 is a rear view thereof;

FIG. 4 is a first side view thereof;

FIG. 5 is a second side view thereof;

FIG. 6 is a top view thereof; and,

FIG. 7 is a bottom view thereof.

1 Claim, 4 Drawing Sheets

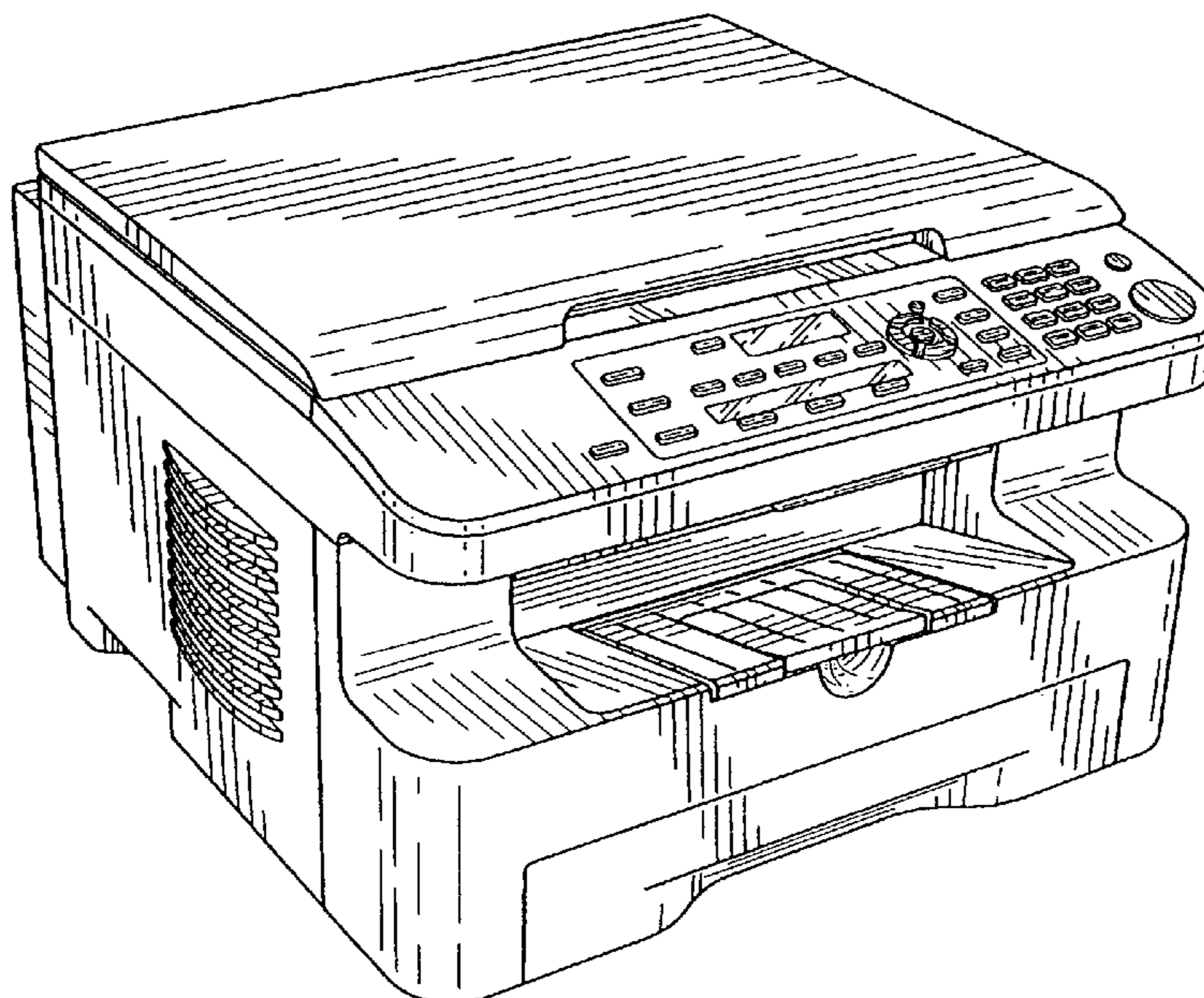

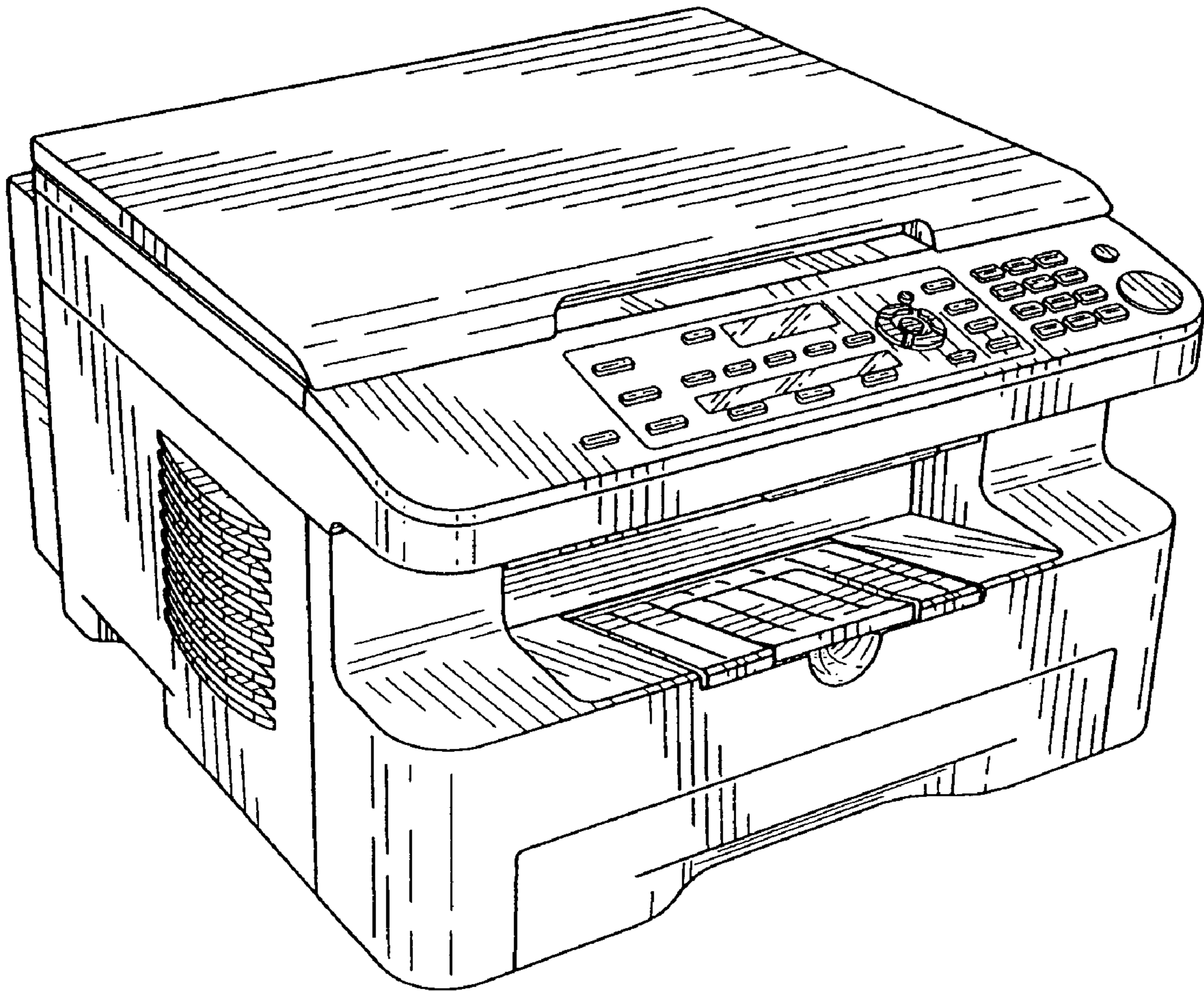

FIG.1

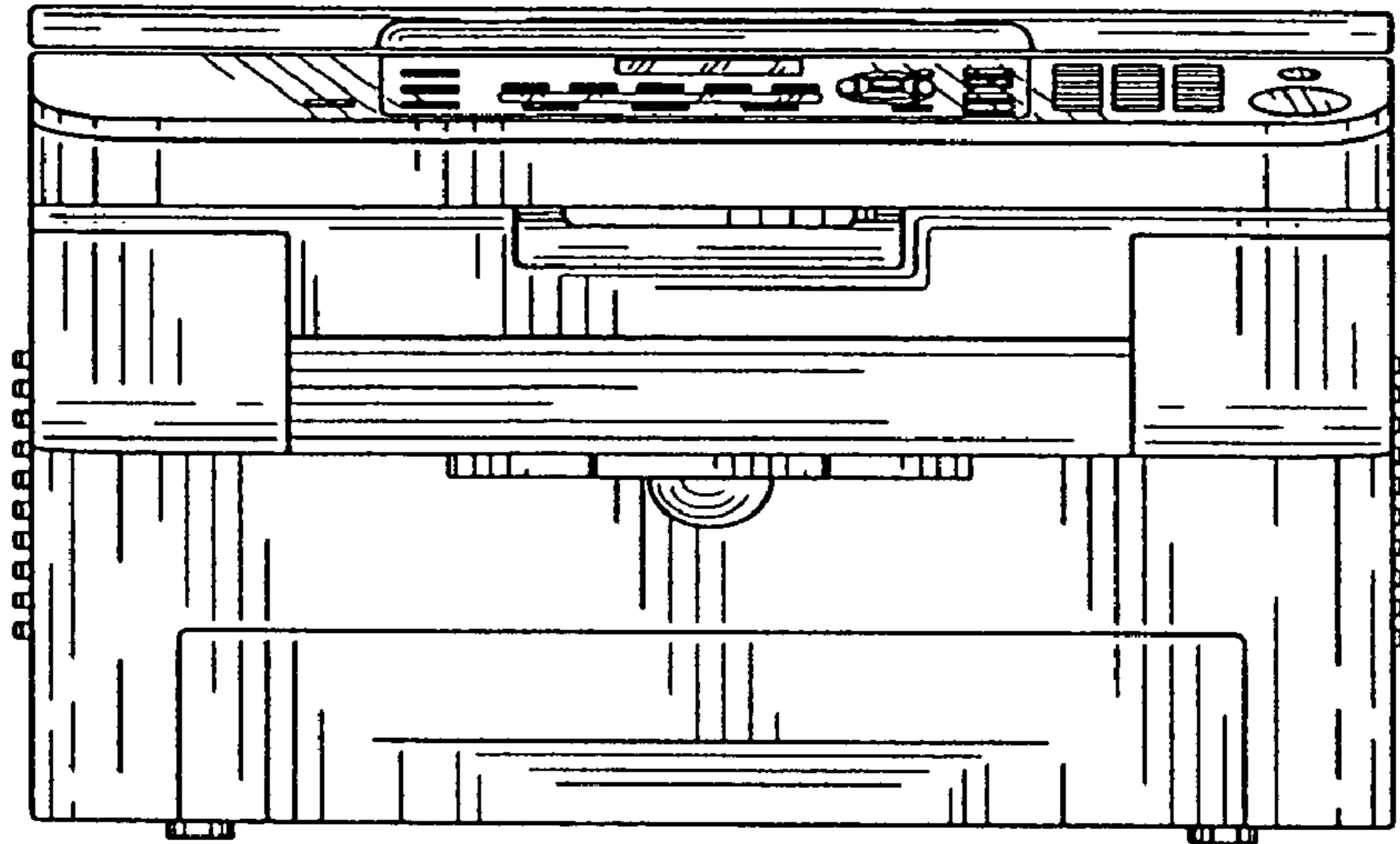

FIG. 2

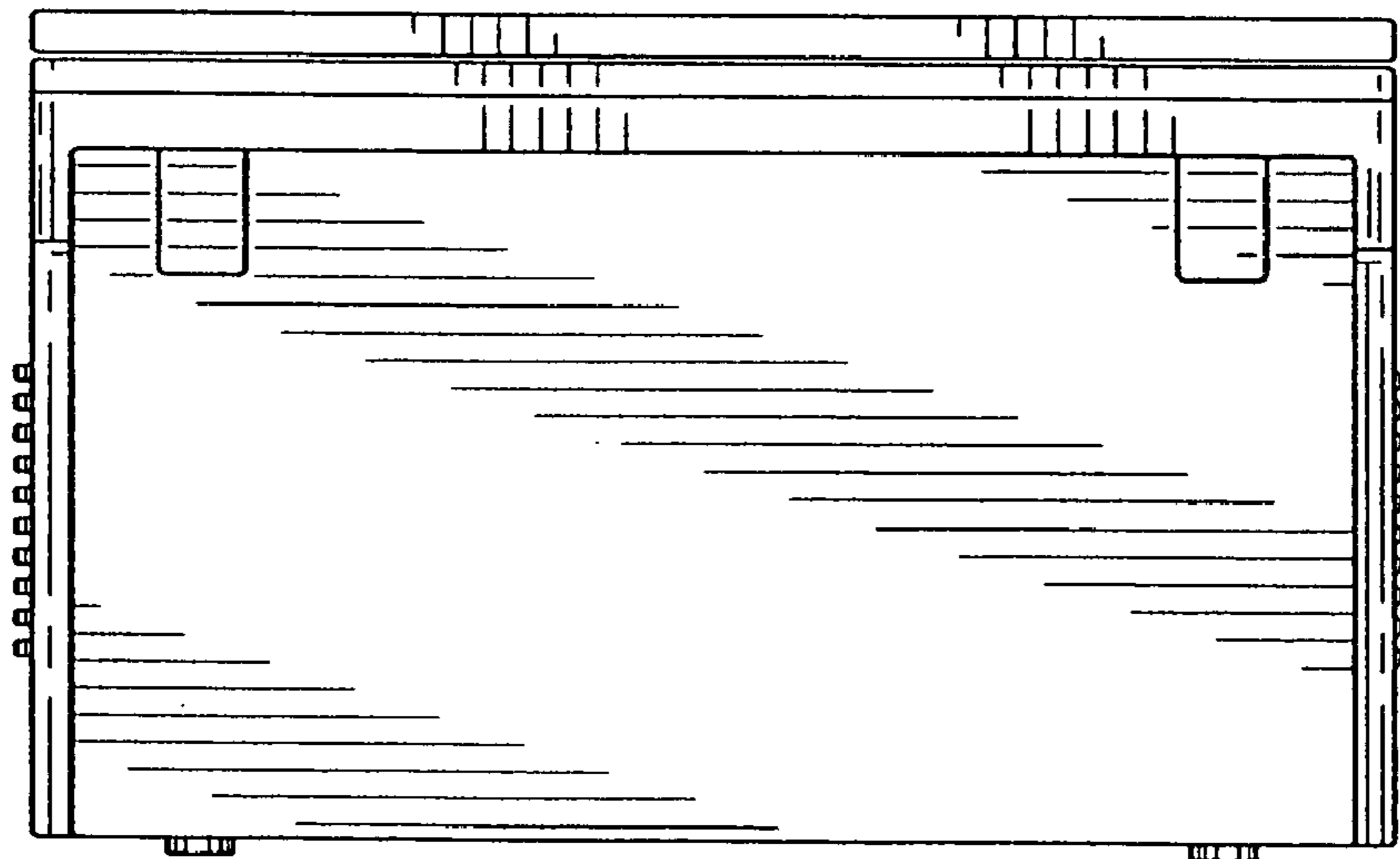

FIG. 3

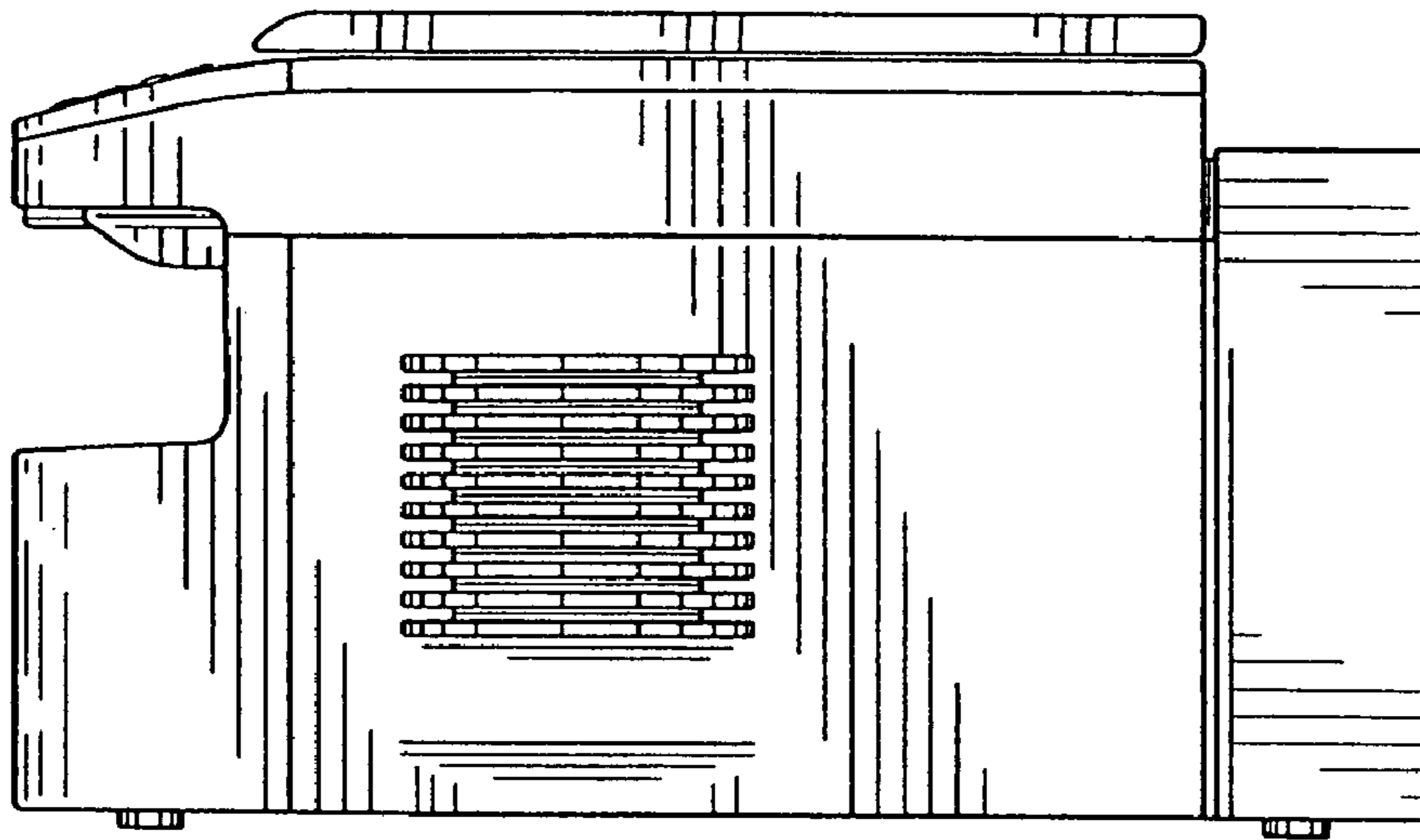

FIG. 4

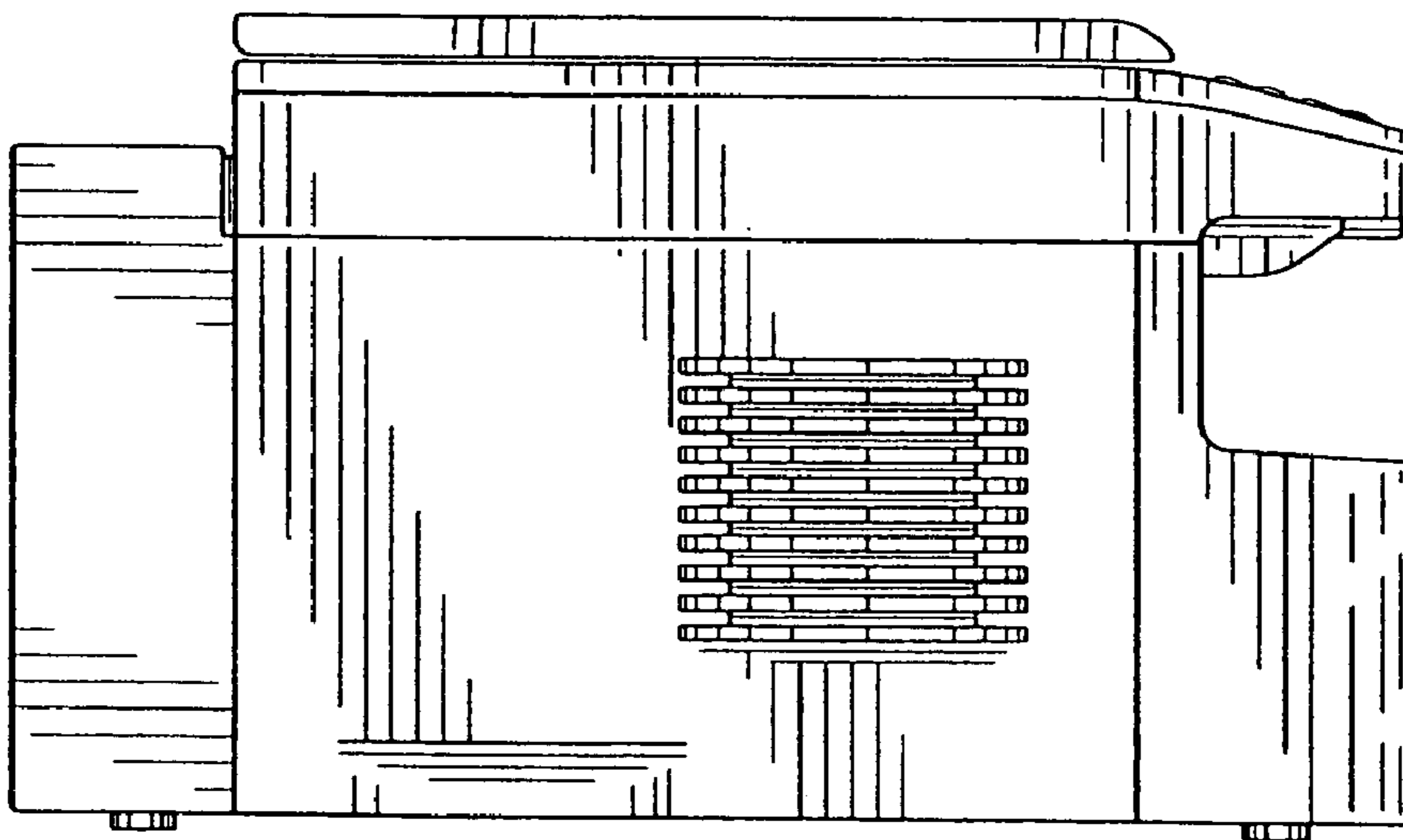

FIG. 5

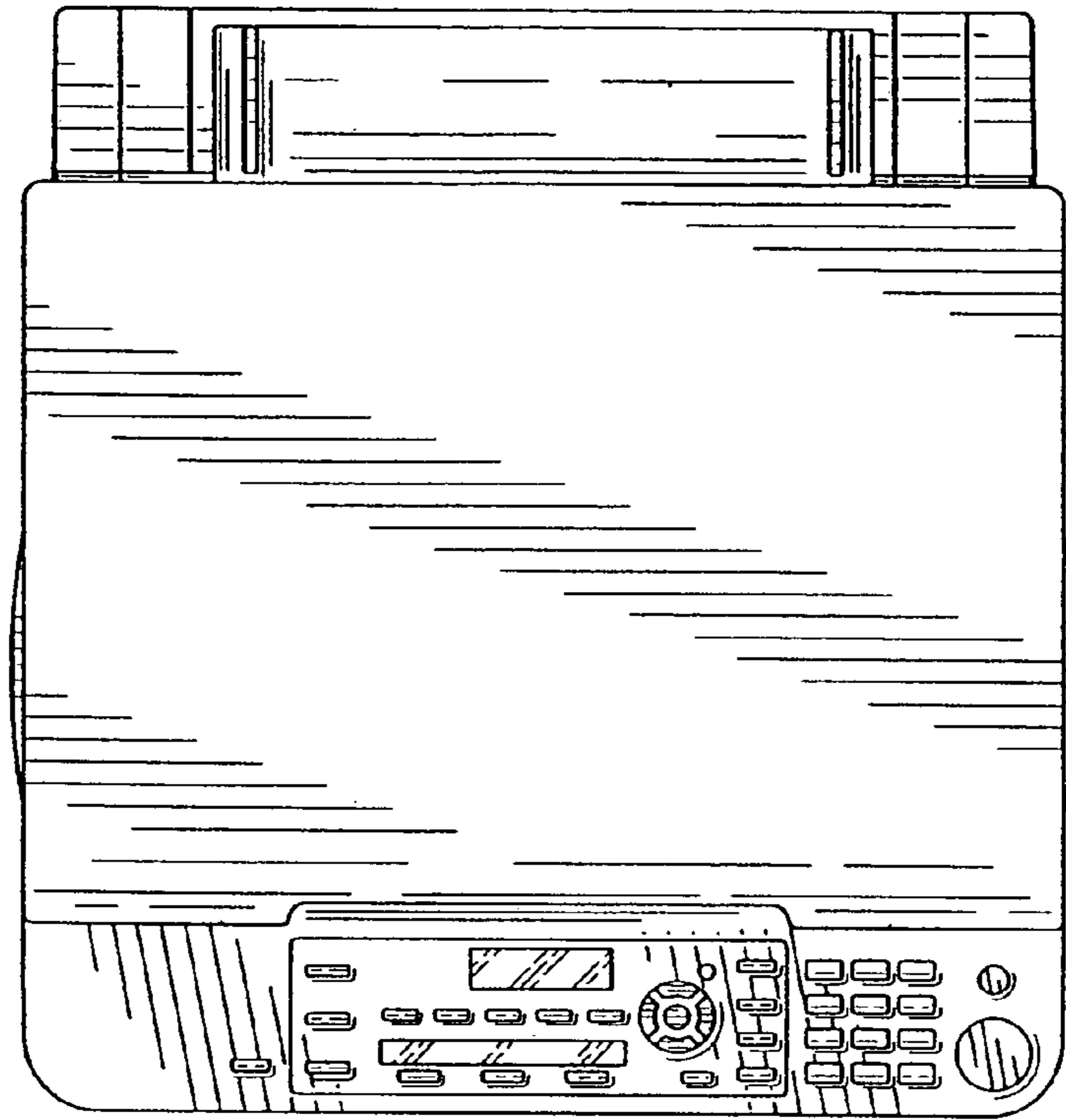

FIG. 6

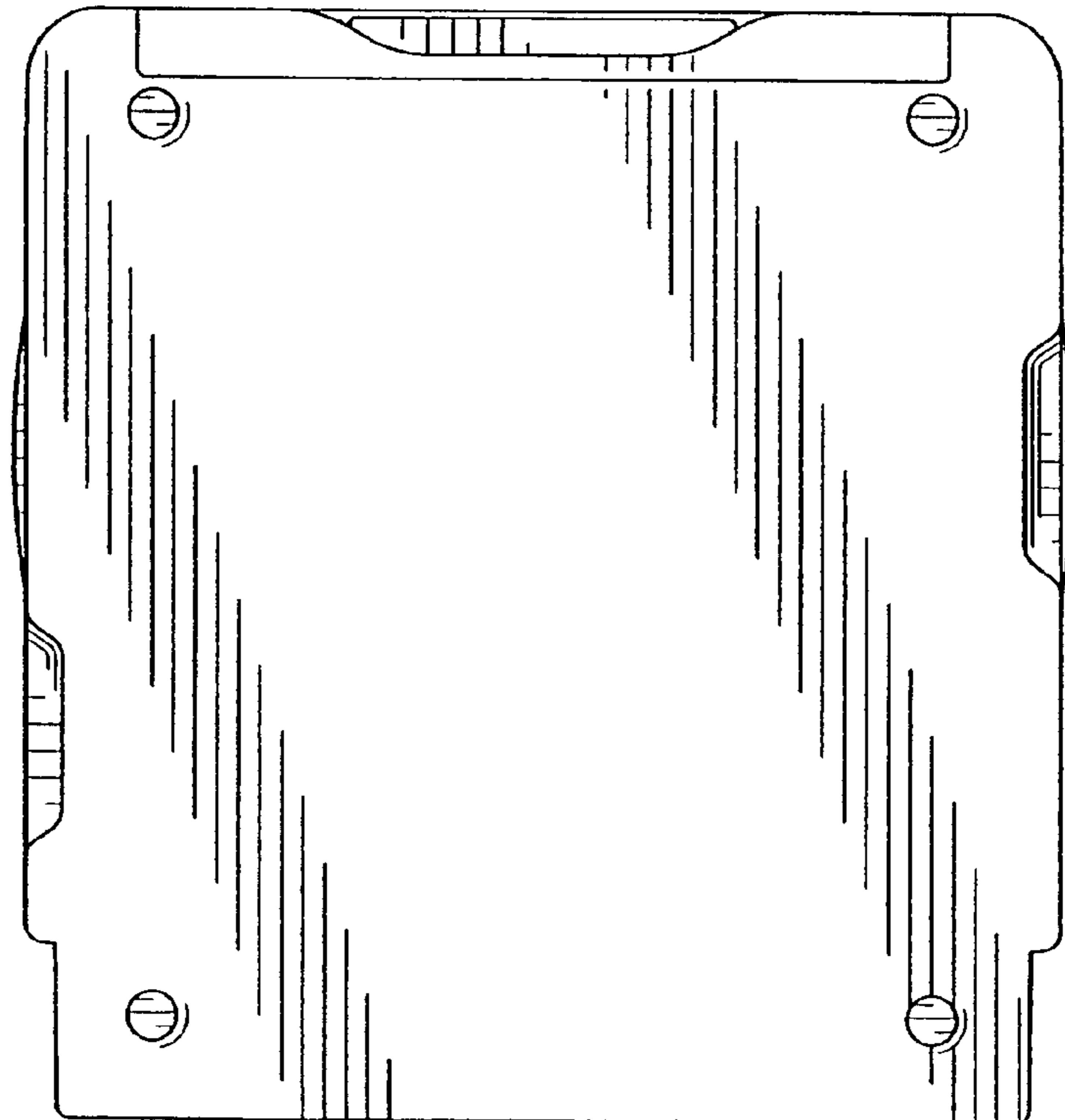

FIG. 7