



US00D565631S

(12) **United States Design Patent**
Morishita

(10) **Patent No.:** **US D565,631 S**

(45) **Date of Patent:** **** Apr. 1, 2008**

(54) **LCD VIDEO PROJECTOR**

(75) Inventor: **Yoshihito Morishita**, Kadoma (JP)

(73) Assignee: **Matsushita Electric Industrial Co., Ltd.**, Osaka (JP)

(**) Term: **14 Years**

(21) Appl. No.: **29/288,286**

(22) Filed: **Jun. 6, 2007**

(30) **Foreign Application Priority Data**

Jan. 10, 2007 (JP) 2007-000189

(51) **LOC (8) Cl.** **16-02**

(52) **U.S. Cl.** **D16/235; D16/230**

(58) **Field of Classification Search** D16/213,
D16/221, 225, 230, 231, 234; D21/514;
353/115, 119, 122

See application file for complete search history.

(56) **References Cited**

U.S. PATENT DOCUMENTS

| | | | |
|----------------|---------|-----------------------|---------|
| D401,955 S | 12/1998 | Kawamoto et al. | |
| D402,679 S | 12/1998 | Kawamoto et al. | |
| D418,532 S | 1/2000 | Kuramoto et al. | |
| D421,037 S | 2/2000 | Kawamoto et al. | |
| D425,097 S | 5/2000 | Kuramoto | |
| D439,923 S | 4/2001 | Kawamoto | |
| D454,903 S | 3/2002 | Kawamoto et al. | |
| D467,604 S | 12/2002 | Niitsu | |
| 6,568,813 B1 * | 5/2003 | Haba et al. | 353/119 |
| D476,353 S | 6/2003 | Morishita et al. | |
| D480,410 S | 10/2003 | Morishita et al. | |
| D482,381 S | 11/2003 | Morishita et al. | |
| D482,716 S | 11/2003 | Azuma et al. | |
| D489,391 S | 5/2004 | Morishita et al. | |
| D491,973 S | 6/2004 | Morishita et al. | |
| D492,714 S | 7/2004 | Morishita et al. | |
| D498,491 S * | 11/2004 | Ohki et al. | D16/235 |
| D498,781 S | 11/2004 | Azuma et al. | |
| D499,753 S * | 12/2004 | Shigemura et al. | D16/230 |

| | | | |
|----------------|---------|-------------------|---------|
| 6,981,770 B2 * | 1/2006 | Murai et al. | 353/119 |
| D527,408 S | 8/2006 | Azuma | |
| D531,201 S | 10/2006 | Azuma | |
| D550,268 S * | 9/2007 | Naruki | D16/230 |

FOREIGN PATENT DOCUMENTS

| | | |
|----|------------|--------|
| JP | D 1145460 | 7/2002 |
| JP | D 1173326 | 5/2003 |
| JP | D. 1201439 | 4/2004 |

OTHER PUBLICATIONS

Sony Corporation, "Compact Data Projector Lineup Catalogue", Jul. 2005, 4 pages.

* cited by examiner

Primary Examiner—Adir Aronovich

(74) *Attorney, Agent, or Firm*—Brinks Hofer Gilson & Lione

(57) **CLAIM**

I claim the ornamental design for a LCD video projector, as shown and described.

DESCRIPTION

FIG. 1 is a front, top and right side perspective view of a LCD video projector of the present invention;

FIG. 2 is a front elevation view thereof;

FIG. 3 is rear elevation view thereof;

FIG. 4 is a right side elevational view thereof;

FIG. 5 is a left side elevational view thereof;

FIG. 6 is a top plan view thereof;

FIG. 7 is a bottom plan view thereof; and,

FIG. 8 is front, top and right side perspective view thereof shown in an opened position.

The broken line showing of LCD video projector is included for the purpose of illustrating environment and forms no part of the claimed design.

1 Claim, 5 Drawing Sheets

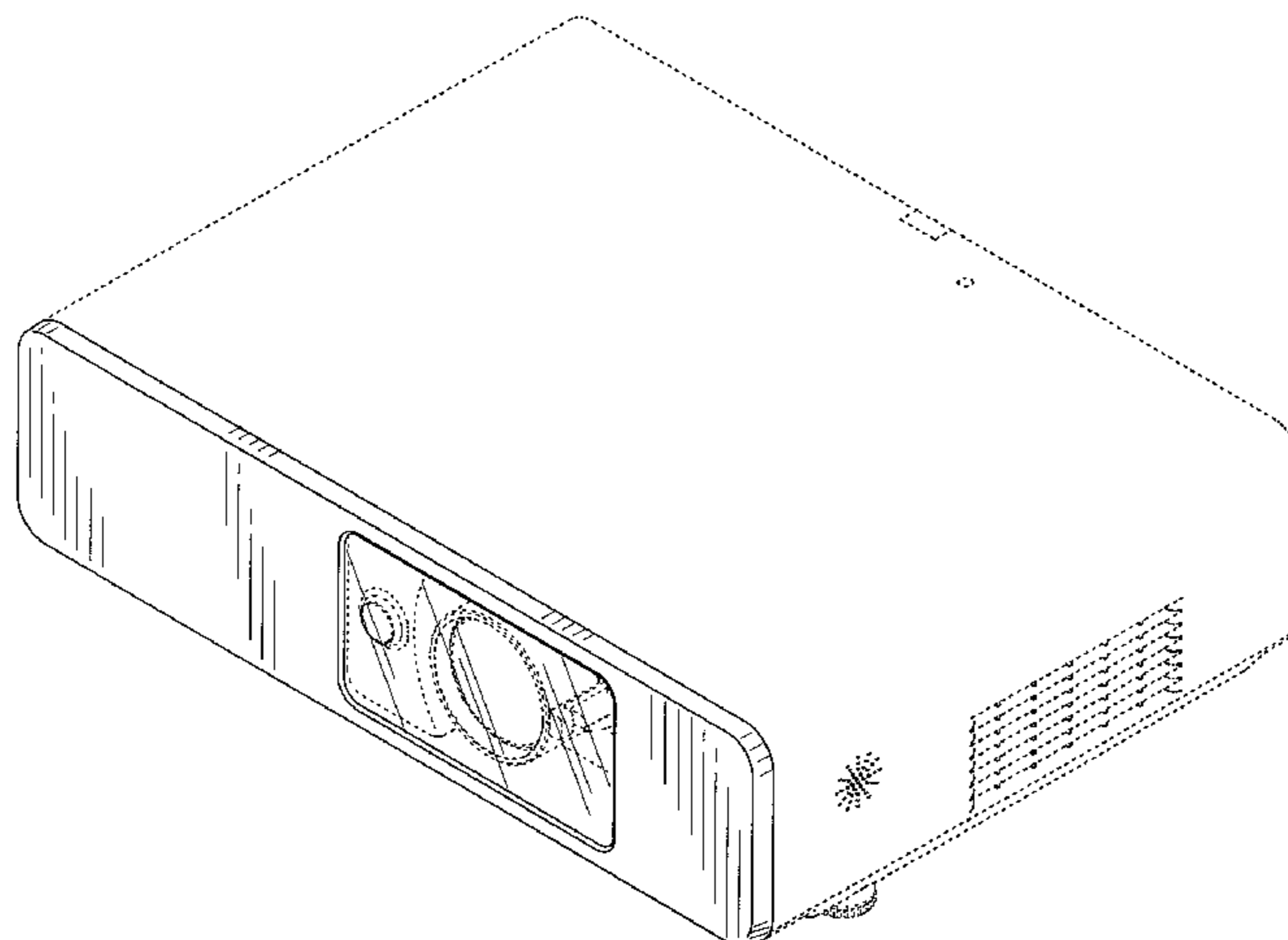

FIG.1

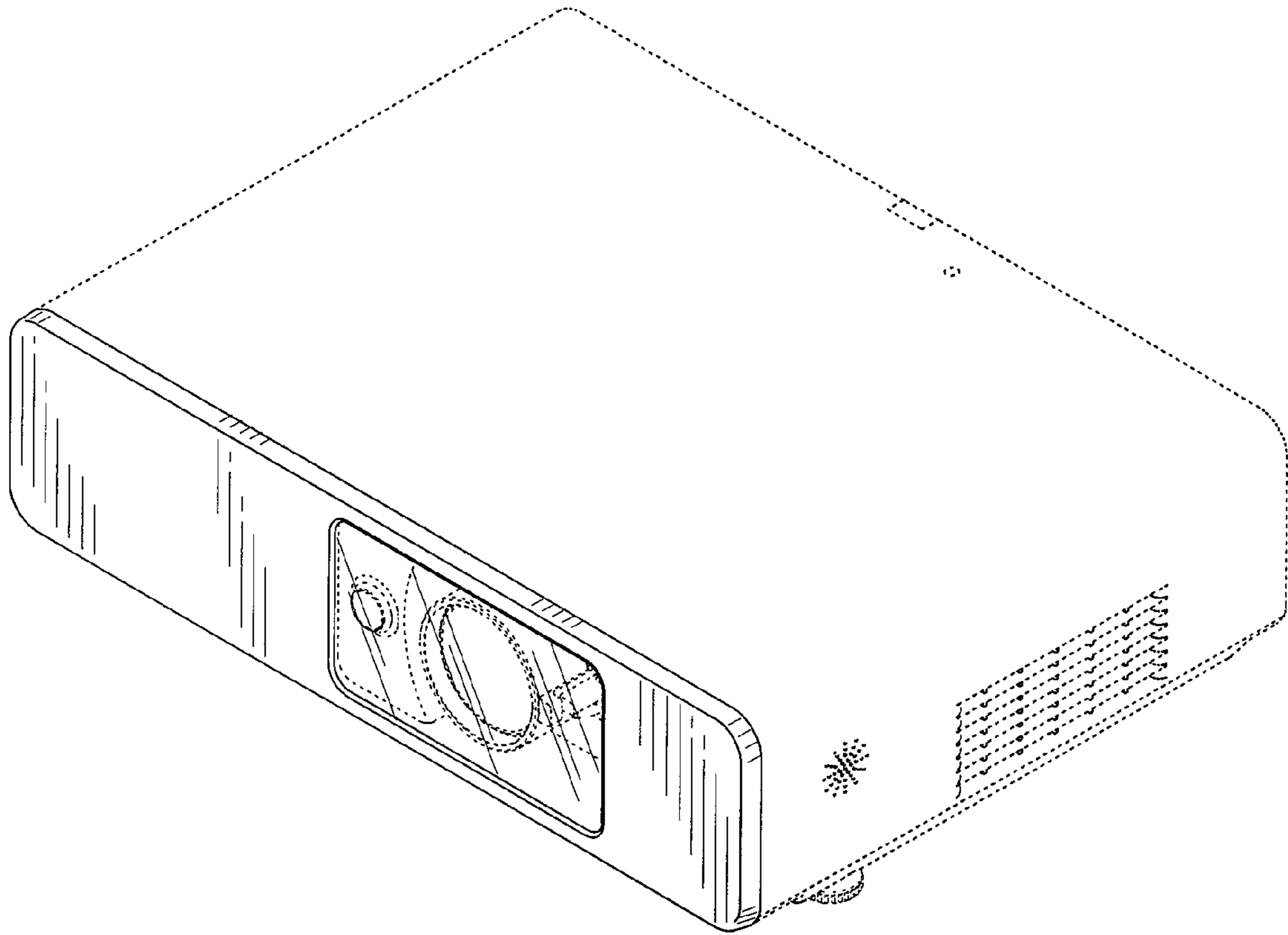

FIG.2

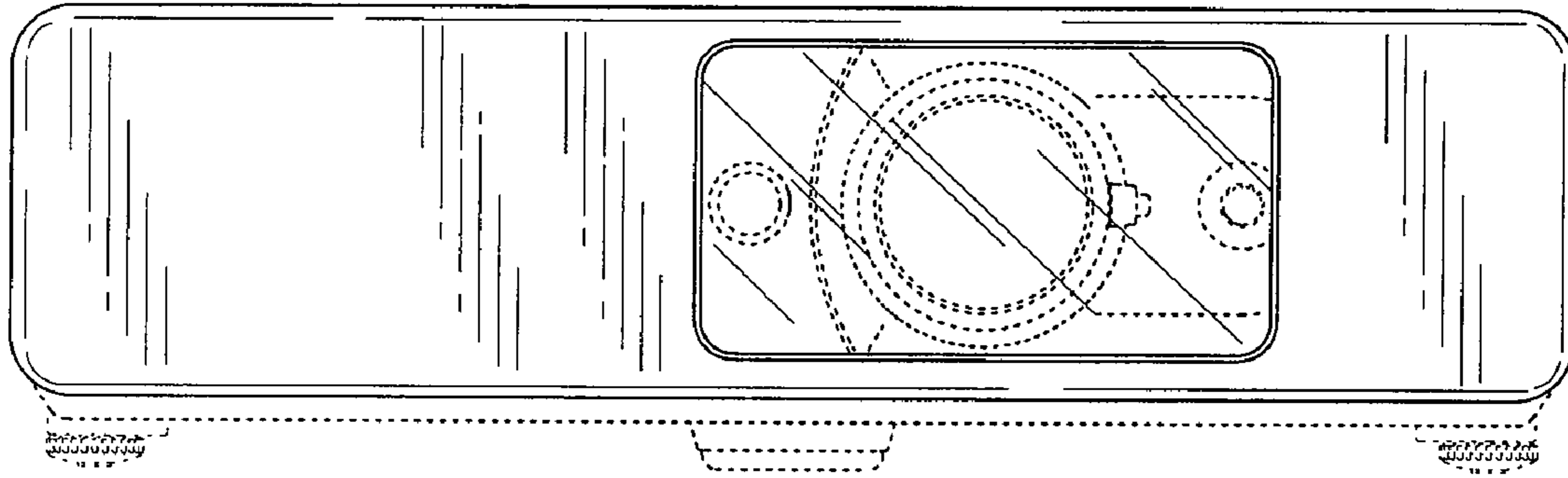

FIG.3

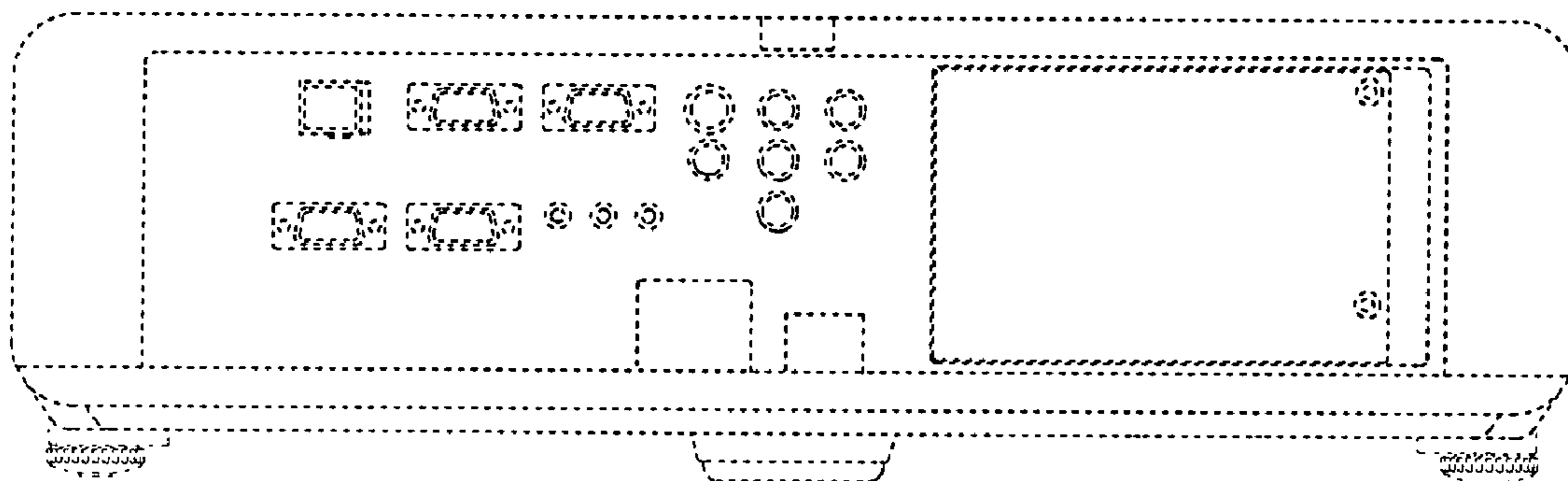

FIG.4

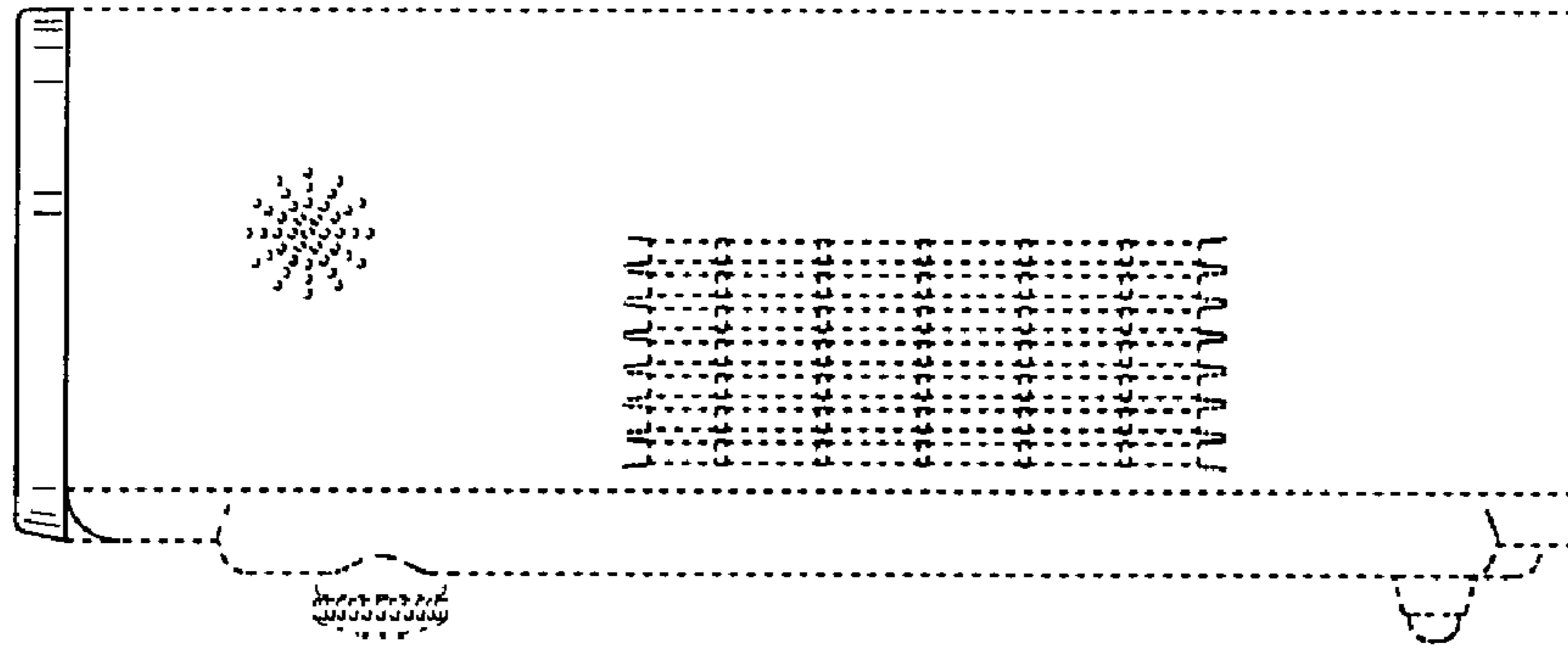

FIG.5

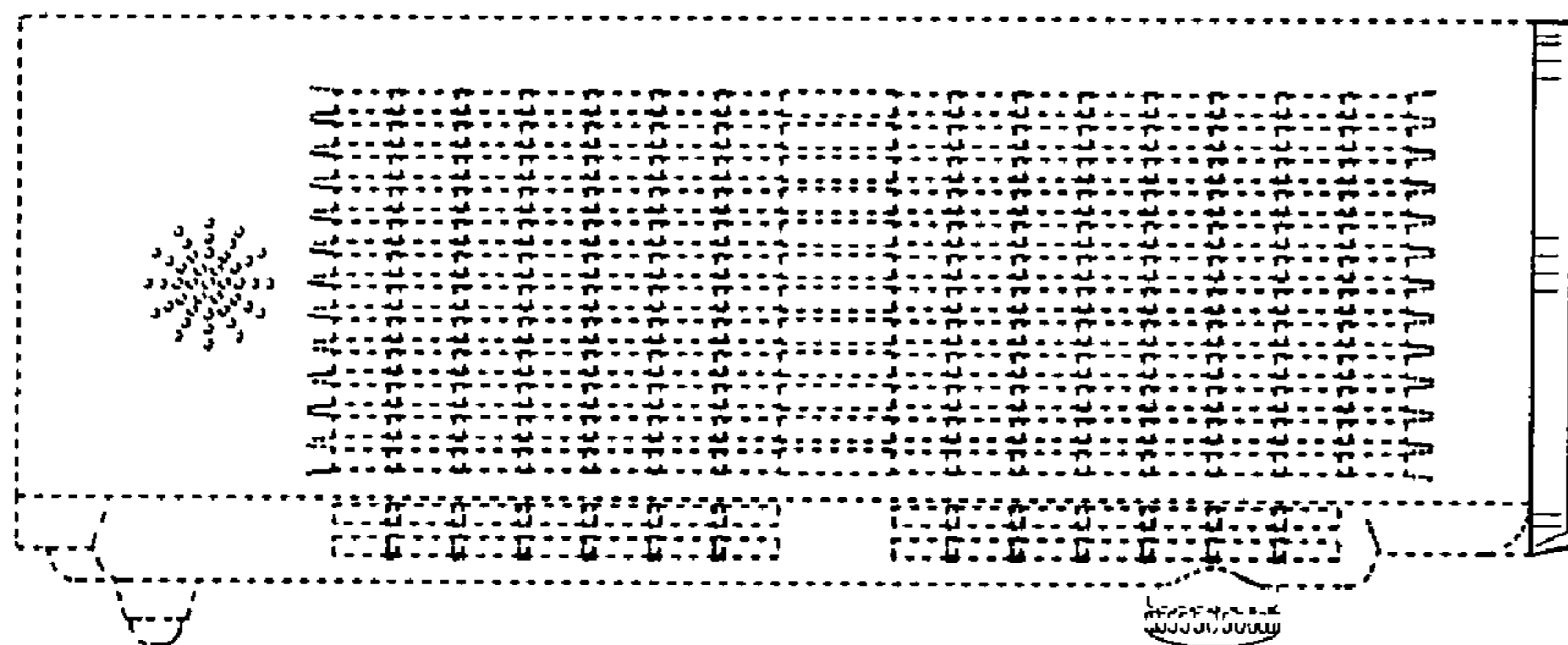

FIG.6

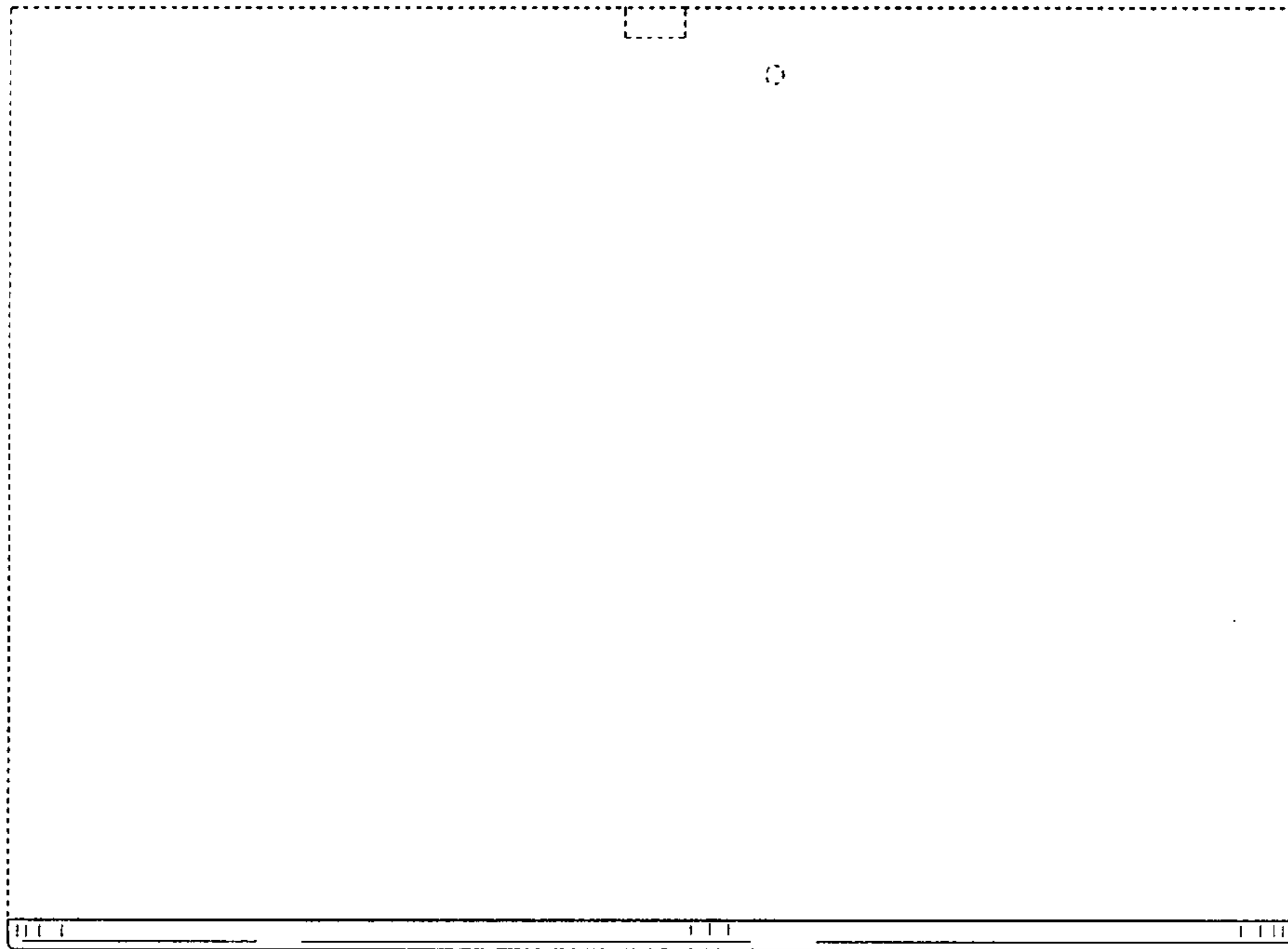

FIG.7

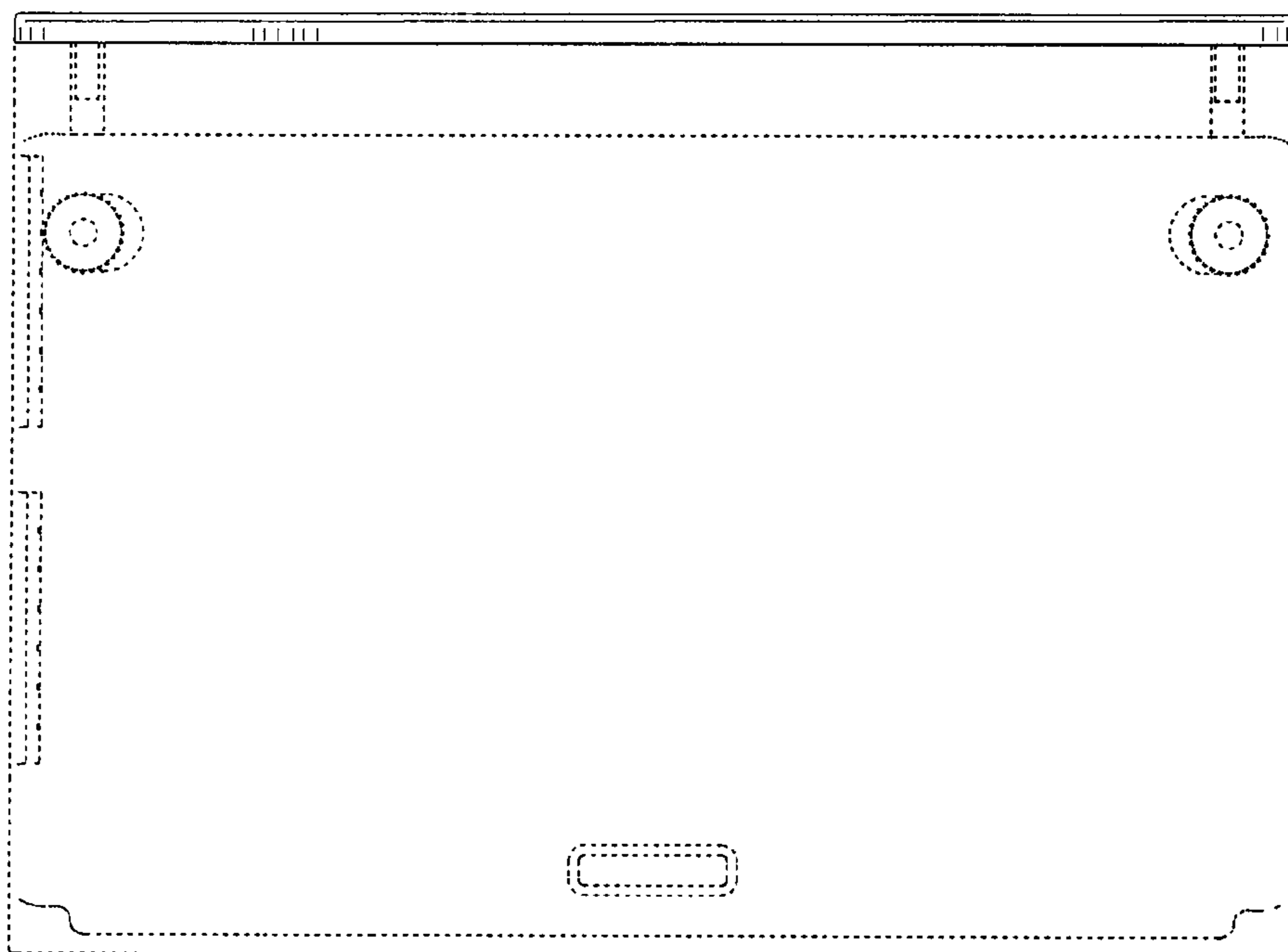

FIG.8

