



US00D565608S

(12) **United States Design Patent** (10) **Patent No.:** **US D565,608 S**
Hirate et al. (45) **Date of Patent:** **** Apr. 1, 2008**

(54) **THREAD STAND FOR SEWING MACHINE**

(75) Inventors: **Masayoshi Hirate**, Ichinomiya (JP);
Minao Chinen, Nagoya (JP)

(73) Assignee: **Tokai Kogyo Mishin Kabushiki Kaisha** (JP)

(**) Term: **14 Years**

(21) Appl. No.: **29/276,780**

(22) Filed: **Feb. 5, 2007**

(30) **Foreign Application Priority Data**

Aug. 10, 2006 (JP) 2006-021405

(51) **LOC (8) Cl.** **15-06**

(52) **U.S. Cl.** **D15/72**

(58) **Field of Classification Search** D15/66,
D15/72, 78; D3/18, 24, 25; D6/521, 522;
211/1.53, 85.5; 112/270, 279, 400; 223/106;
242/134, 597.7

See application file for complete search history.

(56) **References Cited**

U.S. PATENT DOCUMENTS

- 3,987,978 A * 10/1976 Alberelli et al. 242/134
- D282,312 S * 1/1986 Dick D3/24
- D292,643 S * 11/1987 Dick et al. D3/24
- D372,118 S * 7/1996 Moss et al. D3/24
- D447,755 S * 9/2001 Howard D15/72
- D450,442 S * 11/2001 Leonard D3/18
- D486,837 S * 2/2004 Mori et al. D15/72
- D499,916 S * 12/2004 Yang et al. D6/521
- D521,287 S * 5/2006 Mellen et al. D6/521
- D523,268 S * 6/2006 Goodman et al. D6/521
- D530,549 S * 10/2006 Yang et al. D6/521
- 2004/0159738 A1 * 8/2004 Duncan et al. 242/597.7
- 2004/0195429 A1 * 10/2004 Demers et al. 242/597.7

* cited by examiner

Primary Examiner—Stella M. Reid

Assistant Examiner—Shanda C. Hill

(74) *Attorney, Agent, or Firm*—Rossi, Kimms & McDowell,
LLP

(57) **CLAIM**

The ornamental design for a thread stand for sewing machine, as shown and described.

DESCRIPTION

FIG. 1 is a perspective view of a thread stand for sewing machine showing our new design;

FIG. 2 is a top plan view thereof;

FIG. 3 is a left side view thereof, the right side view being identical;

FIG. 4 is a front view thereof, the rear view being identical;

FIG. 5 is a bottom plan view thereof;

FIG. 6 is a top plan view of the rod of the thread stand for sewing machine;

FIG. 7 is a left side view thereof, the right side view being identical;

FIG. 8 is a front view thereof, the rear view being identical;

FIG. 9 is a bottom plan view thereof;

FIG. 10 is a perspective view thereof;

FIG. 11 is a top plan view of the tray of the thread stand for sewing machine;

FIG. 12 is a left side view thereof, the right side view being identical;

FIG. 13 is a front view thereof, the rear view being identical;

FIG. 14 is a bottom plan view thereof;

FIG. 15 is a cross sectional view thereof, taken along line 15—15 of FIG. 11;

FIG. 16 is a top perspective view thereof;

FIG. 17 is a bottom perspective view thereof; and,

FIG. 18 is a perspective view of FIG. 1 shown in condition of use.

The broken lines shown in the drawing disclosure are for illustrative purposes only and form no part of the claimed design.

1 Claim, 5 Drawing Sheets

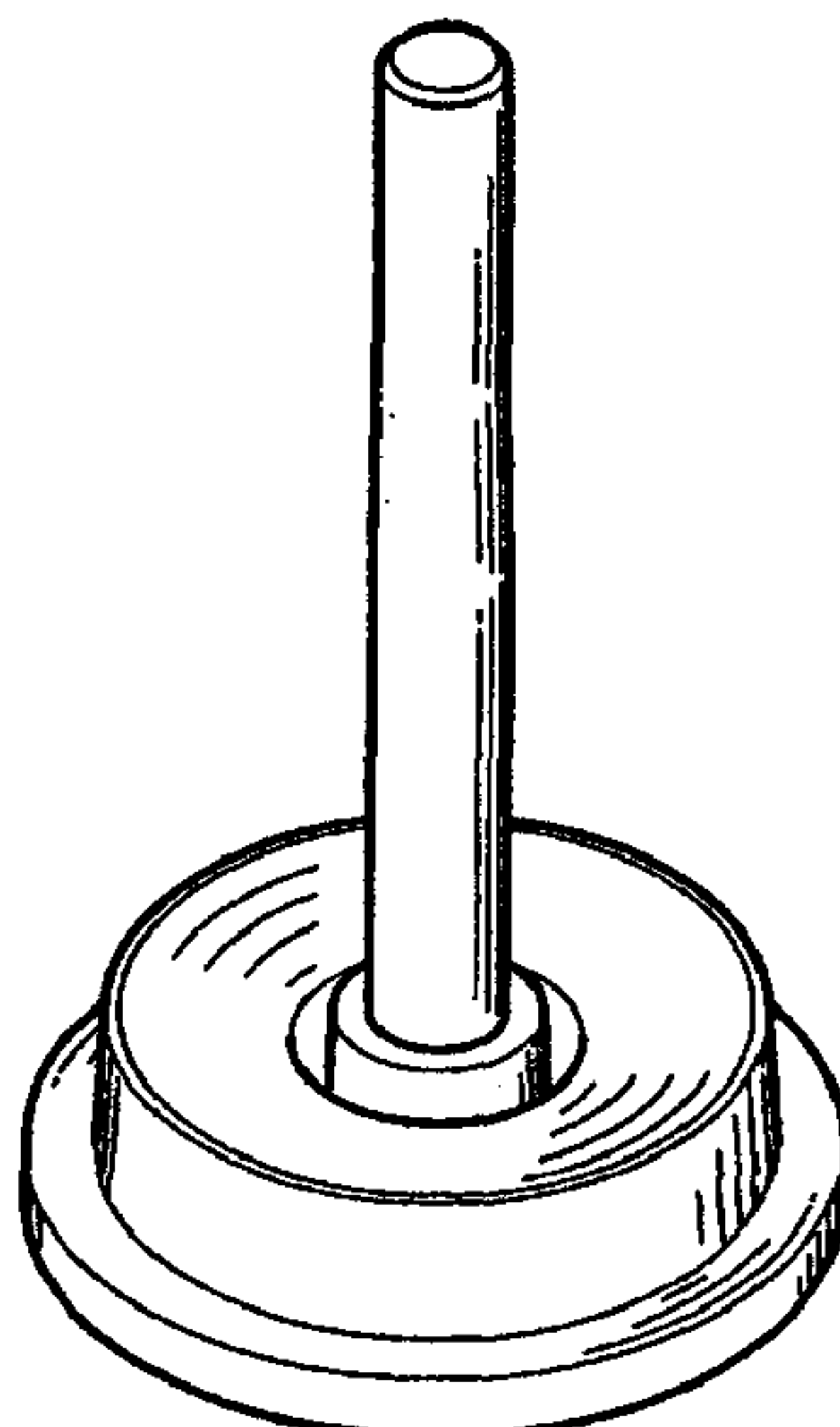

FIG. 1

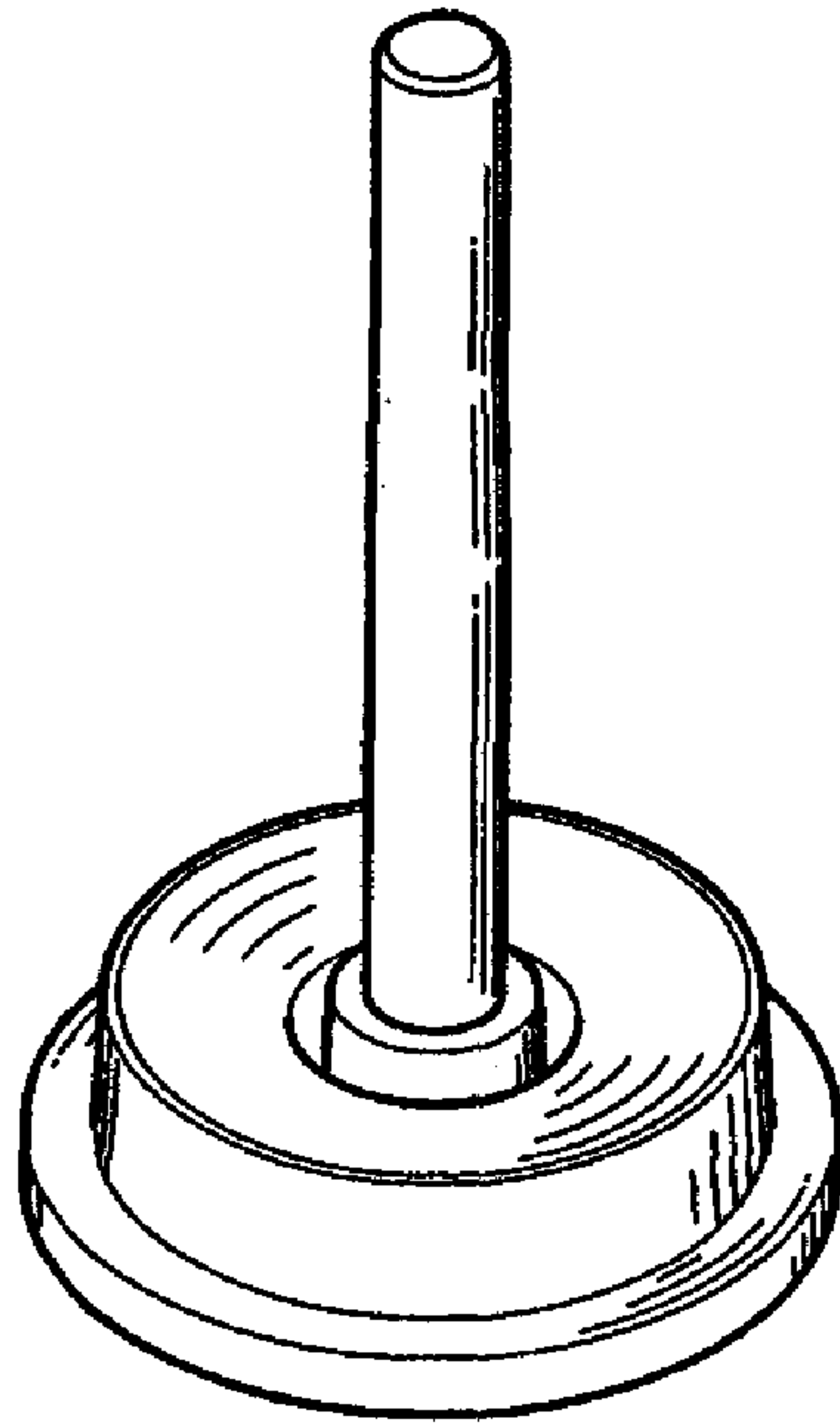

FIG. 10



FIG. 16

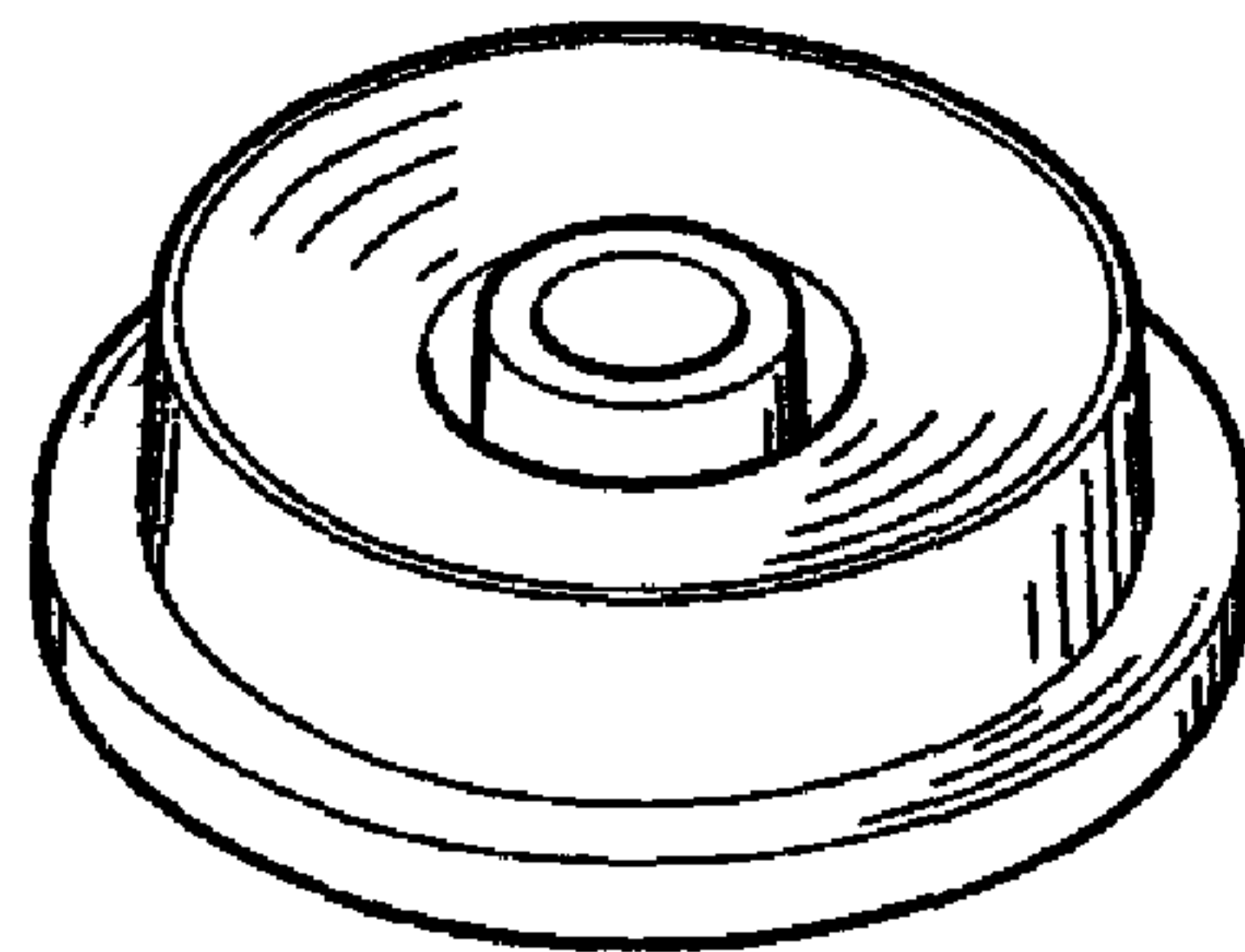

FIG. 17

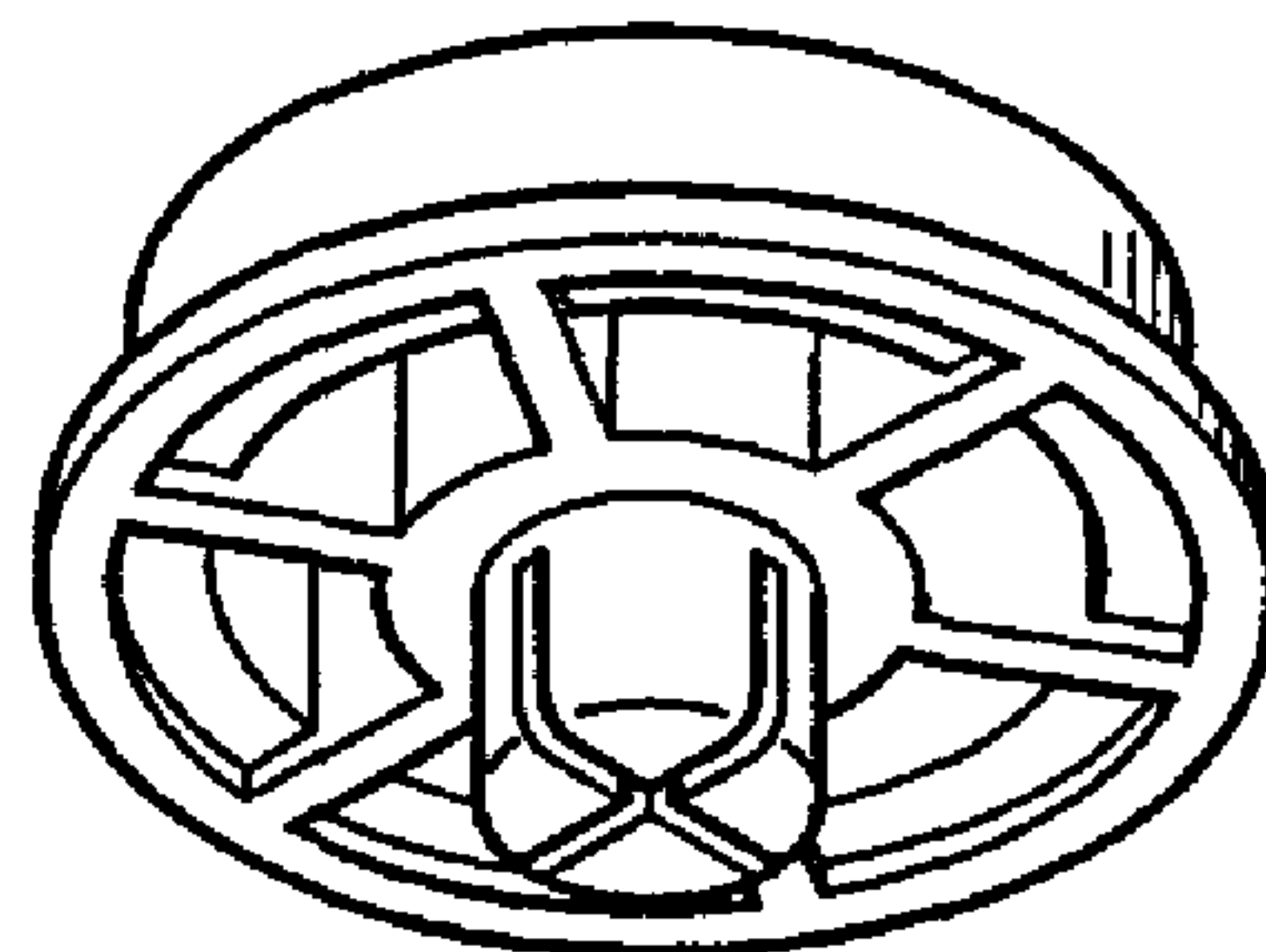

FIG. 2

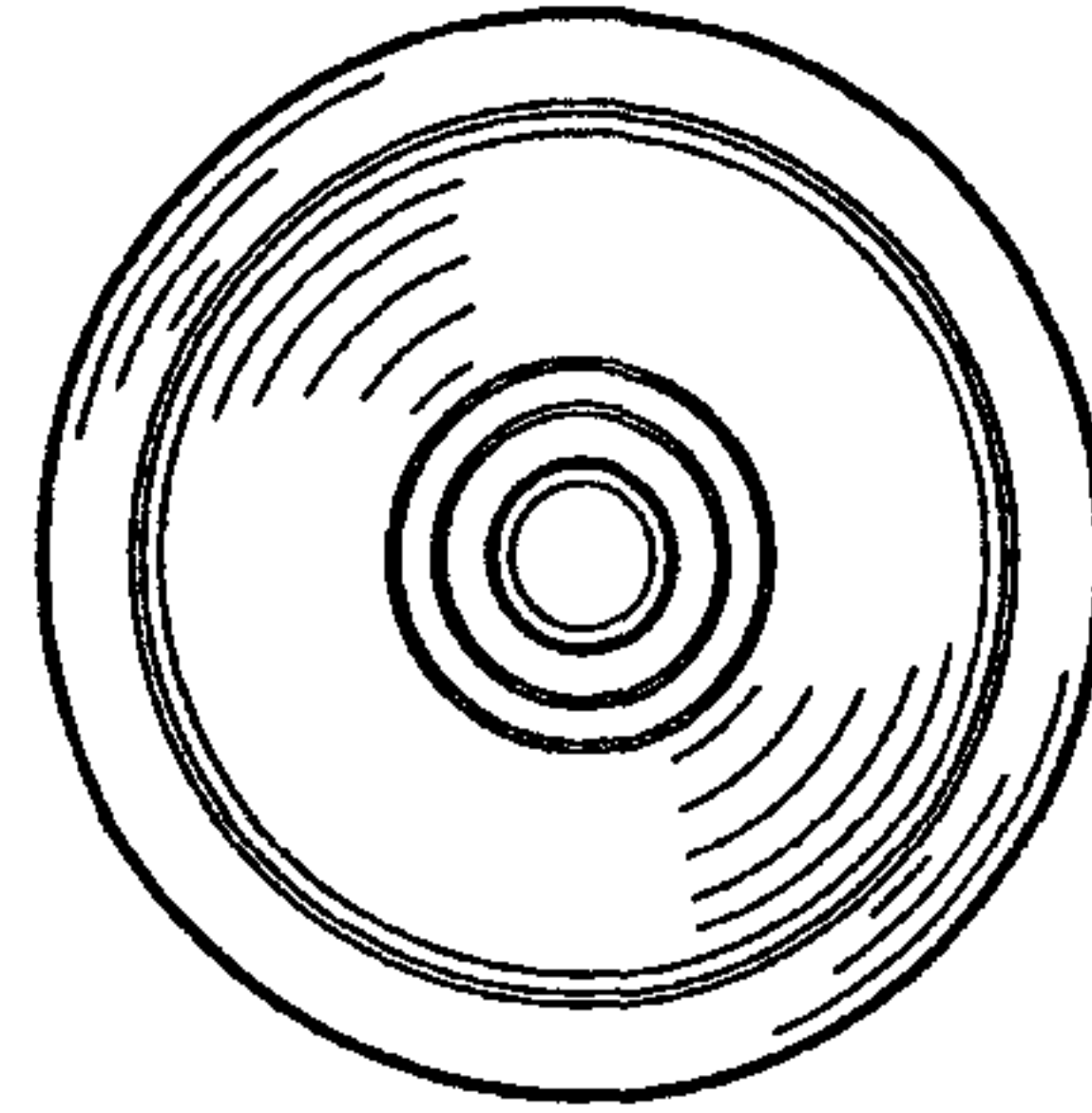

FIG. 3

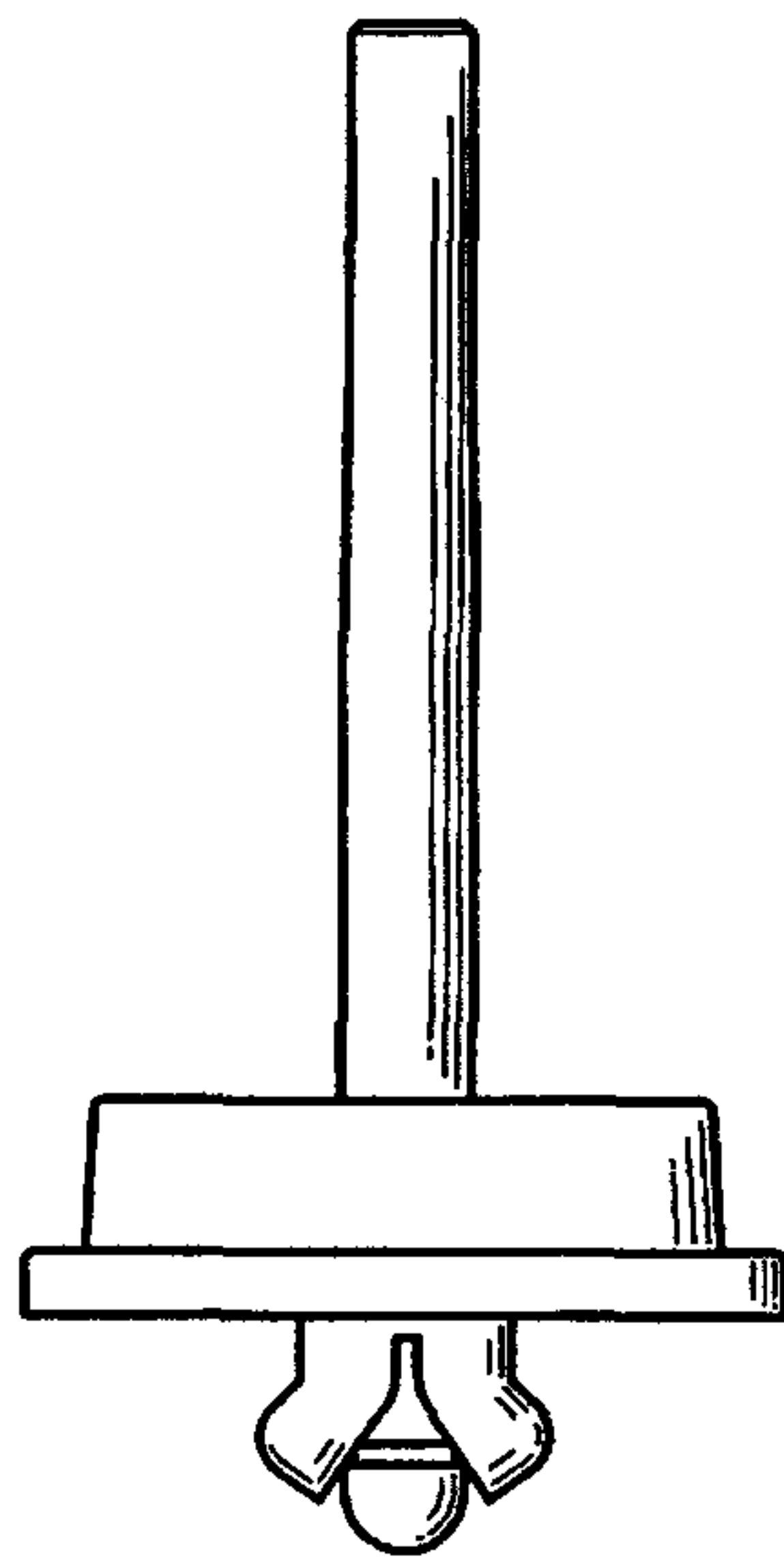

FIG. 4

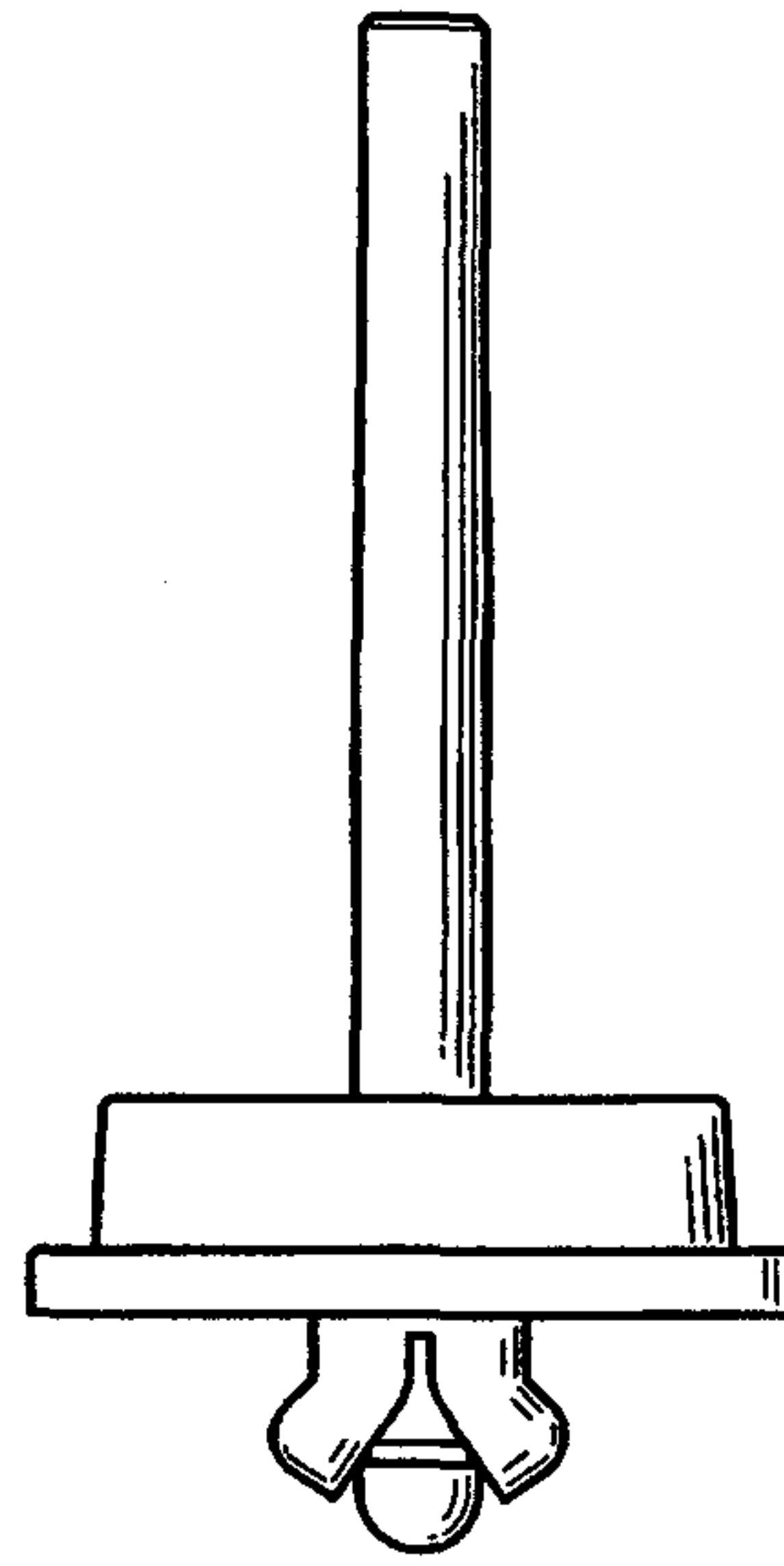

FIG. 5

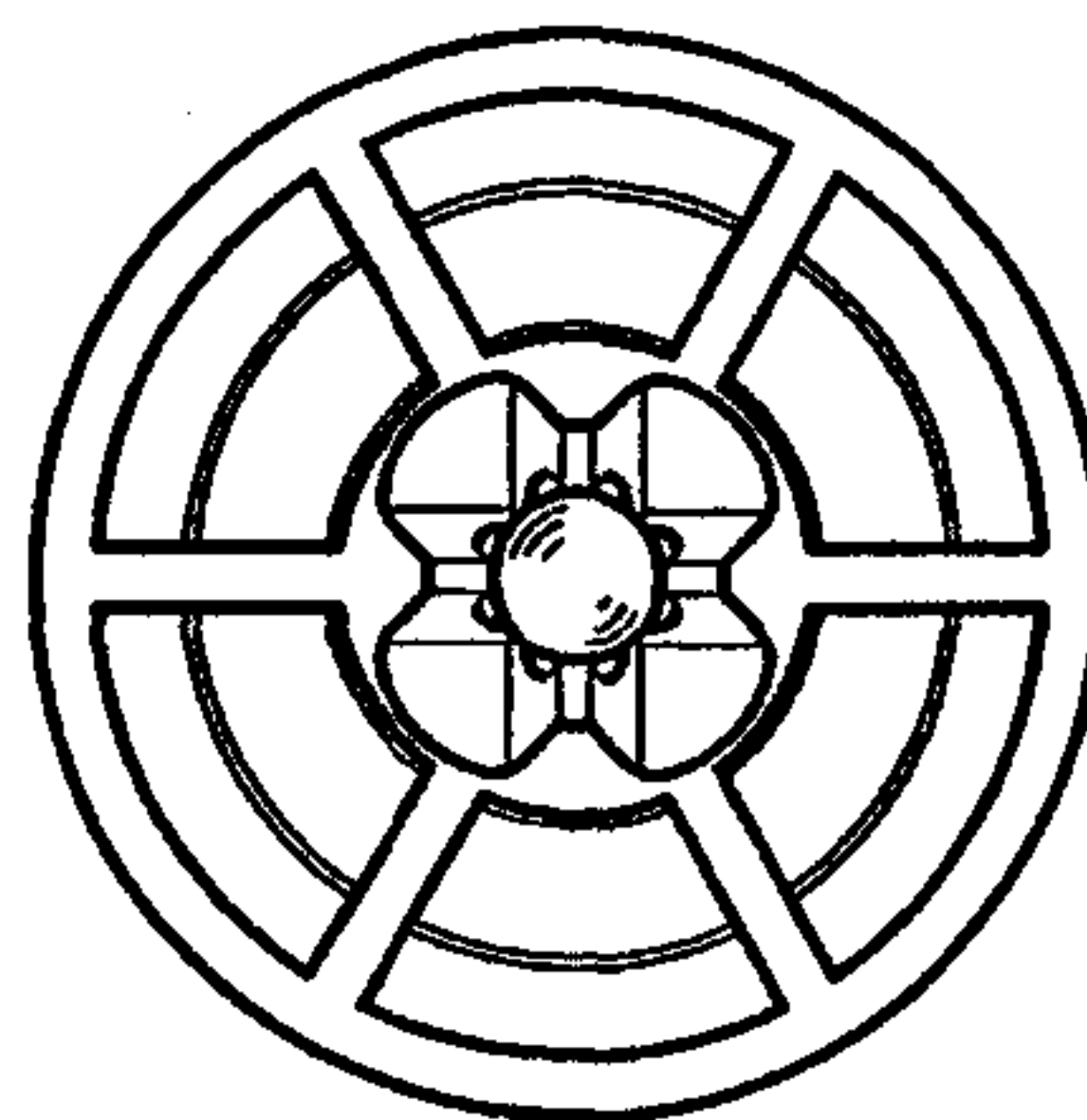

FIG. 6



FIG. 7



FIG. 8



FIG. 9



FIG. 11

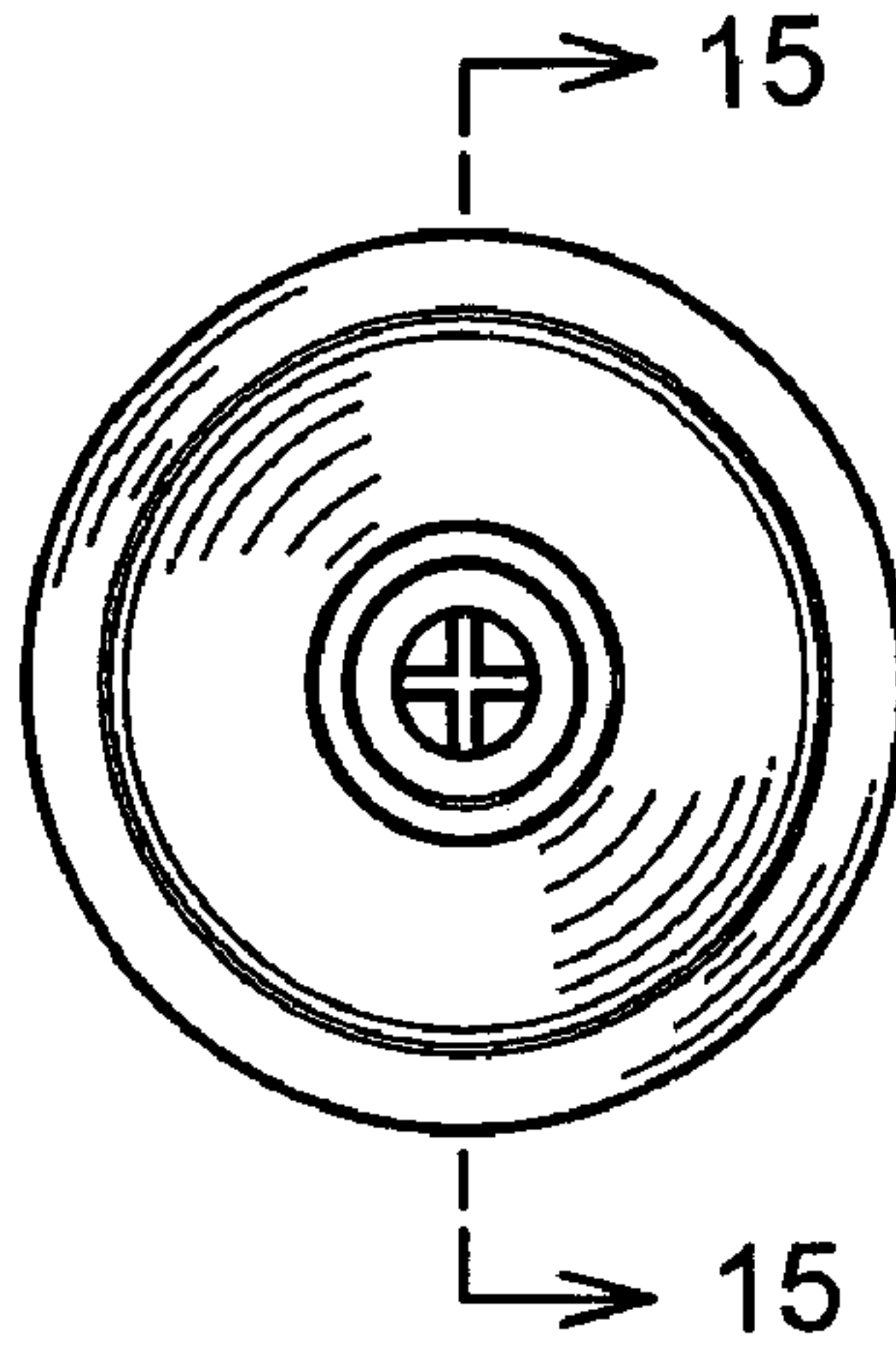

FIG. 12

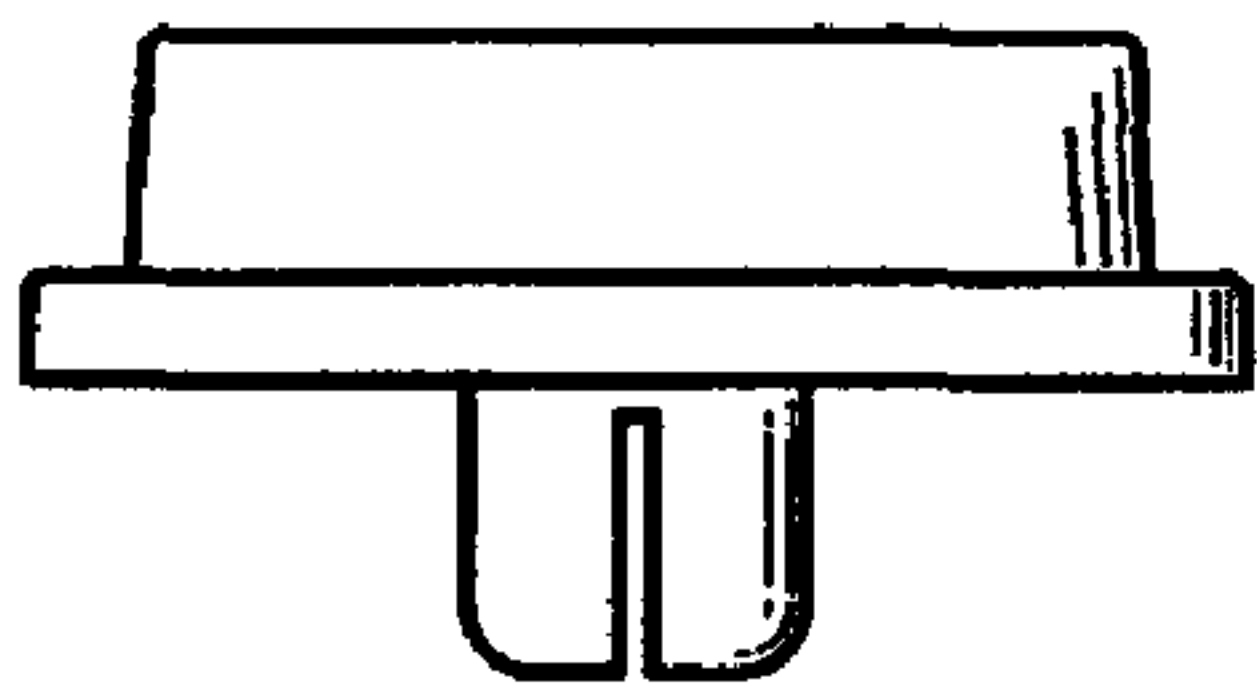

FIG. 13

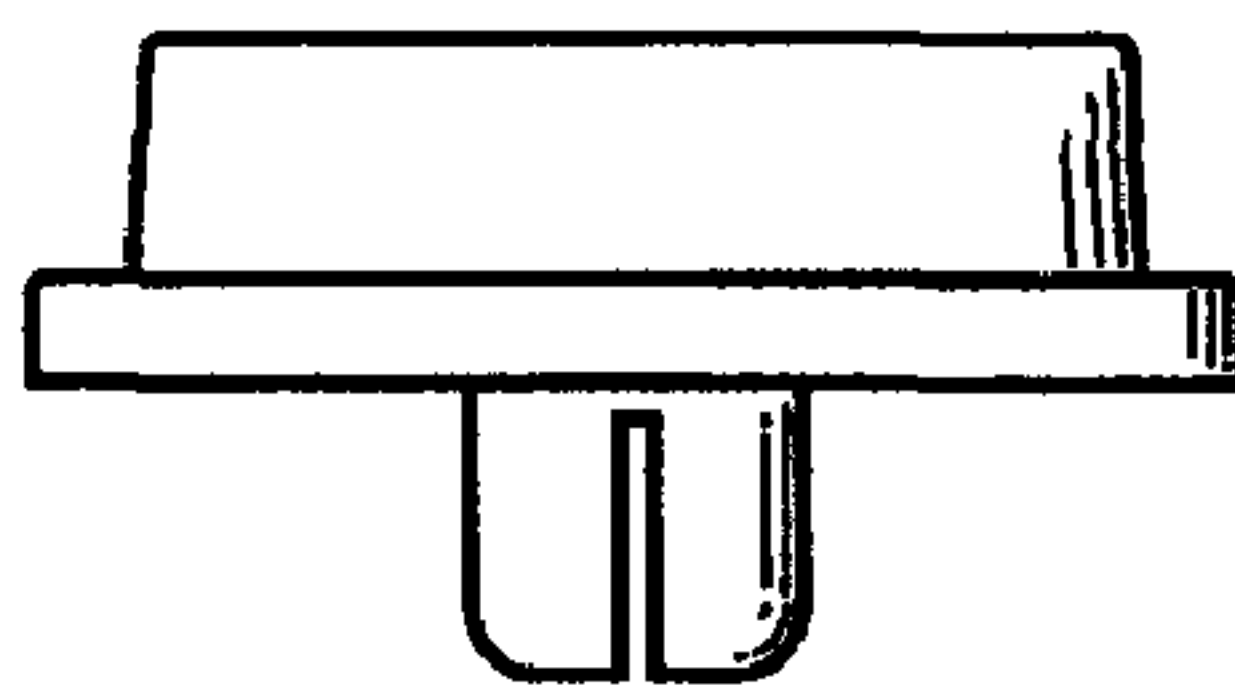

FIG. 15

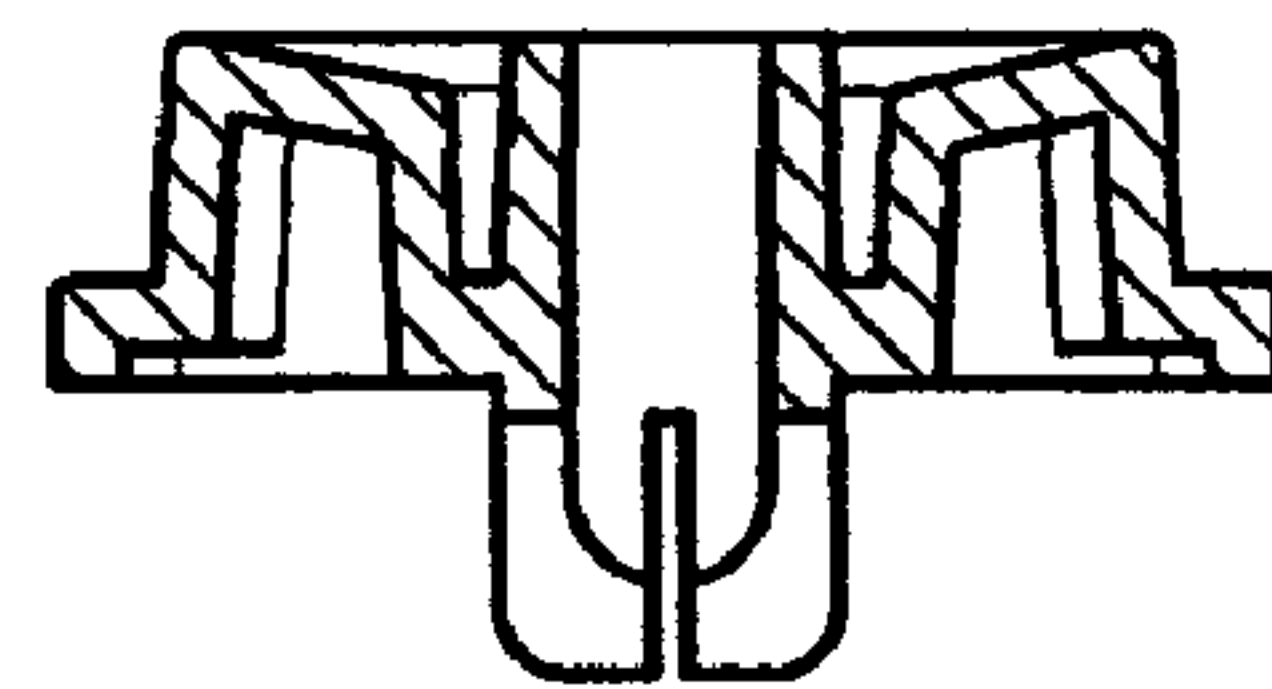

FIG. 14

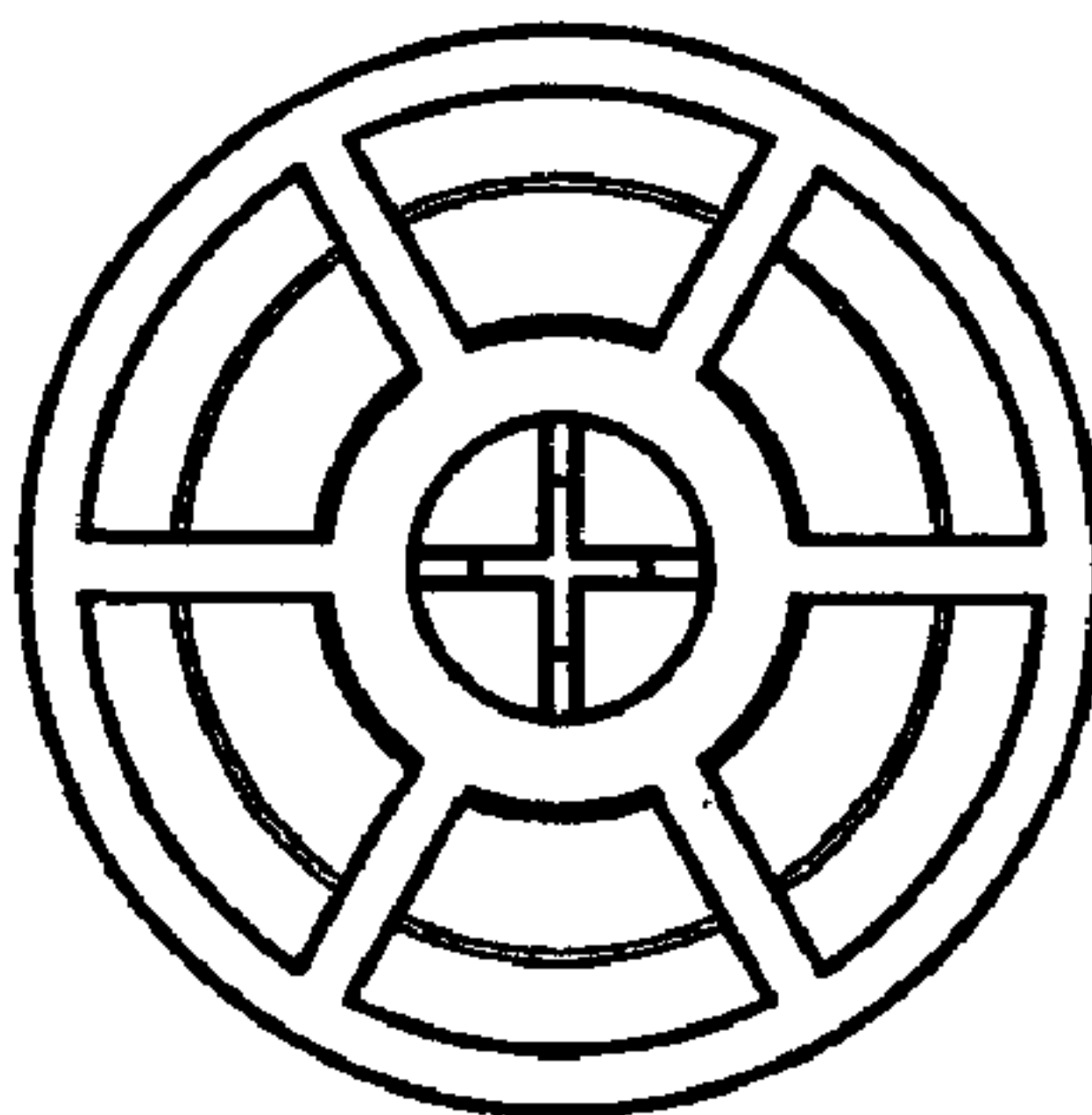

FIG. 18

