

US00D565456S

(12) **United States Design Patent**
Anderson et al.

(10) **Patent No.:** **US D565,456 S**

(45) **Date of Patent:** **** Apr. 1, 2008**

(54) **PLANT BASE**

D259,775 S * 7/1981 Johnson D11/148
D315,877 S * 4/1991 Hedges D11/143

(75) Inventors: **Norman Anderson**, Brooklyn, NY
(US); **Jonathan Willinger**, Tenafly, NJ
(US); **Klaus Woltmann**, Demarest, NJ
(US)

* cited by examiner

Primary Examiner—Caron D. Veynar

Assistant Examiner—Garth Rademaker

(73) Assignee: **JW Pet Company, Inc.**, Teterboro, NJ
(US)

(74) *Attorney, Agent, or Firm*—Katten Muchin Rosenman
LLP

(**) Term: **14 Years**

(57) **CLAIM**

(21) Appl. No.: **29/283,320**

The ornamental design for a plant base, as shown and described.

(22) Filed: **Aug. 10, 2007**

DESCRIPTION

(51) **LOC (8) Cl.** **11-02**

FIG. 1 is a perspective view of the new design of the plant base;

(52) **U.S. Cl.** **D11/146; D30/106**

FIG. 2 is a right-side view thereof;

(58) **Field of Classification Search** D6/403-405;
D11/143-149; D30/106; D99/19; 47/32.7,
47/33, 41.01, 41.1, 41.11, 44-47, 65, 65.5,
47/66.2, 66.7, 67-69, 83, 84

FIG. 3 is a left-side view thereof;

See application file for complete search history.

FIG. 4 is a front view thereof;

FIG. 5 is a rear view thereof;

(56) **References Cited**

FIG. 6 is a top view thereof; and,

FIG. 7 is a bottom view thereof.

U.S. PATENT DOCUMENTS

D106,787 S * 11/1937 Exelmans D11/149
D224,031 S * 6/1972 Willinger D11/146
D240,305 S * 6/1976 Suchowski D30/106
D249,879 S * 10/1978 Willinger D11/146

The portions shown in broken lines do not form part of the claimed design.

1 Claim, 6 Drawing Sheets

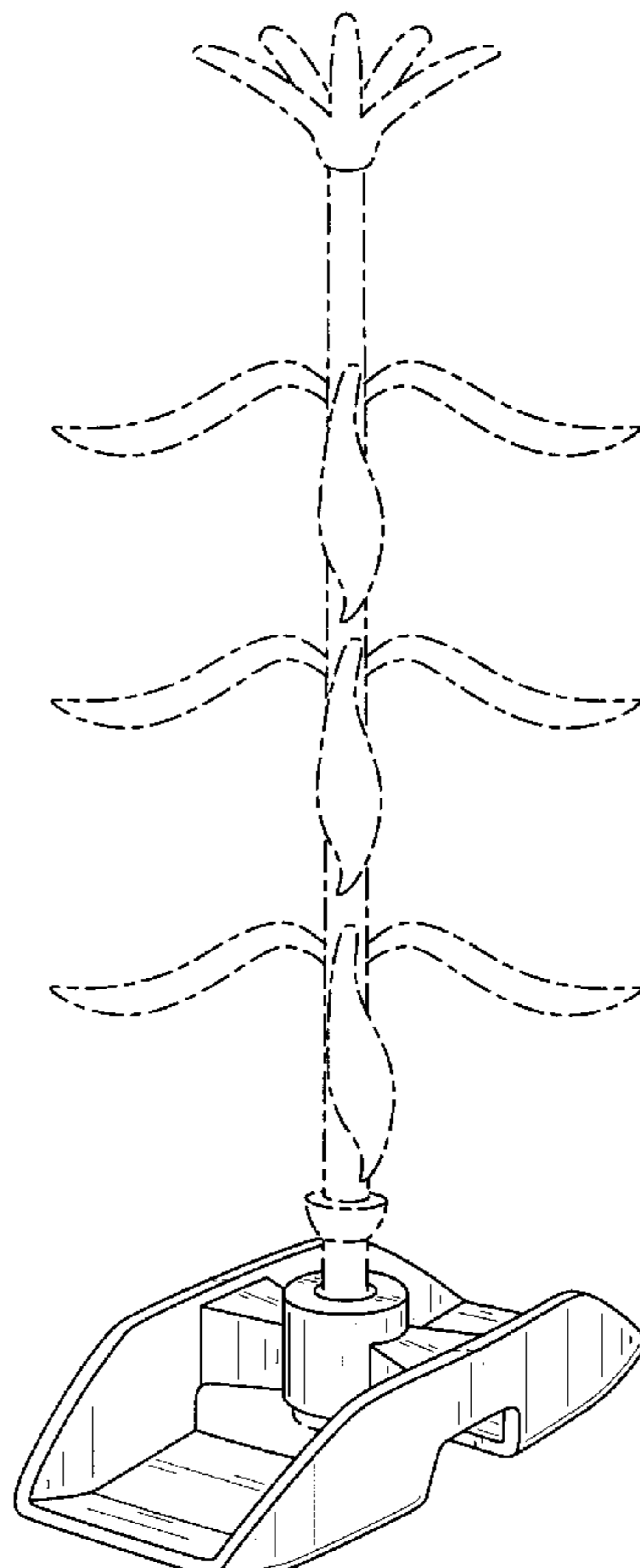

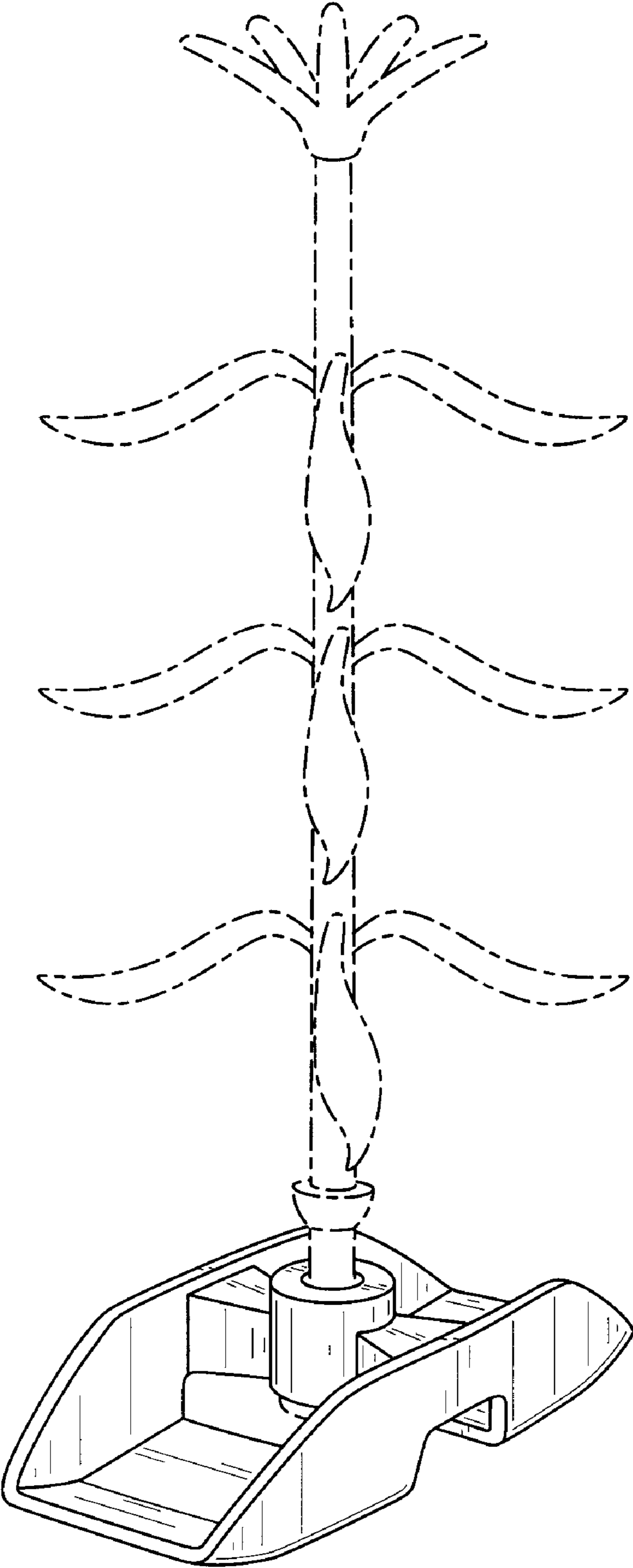

FIG. 1

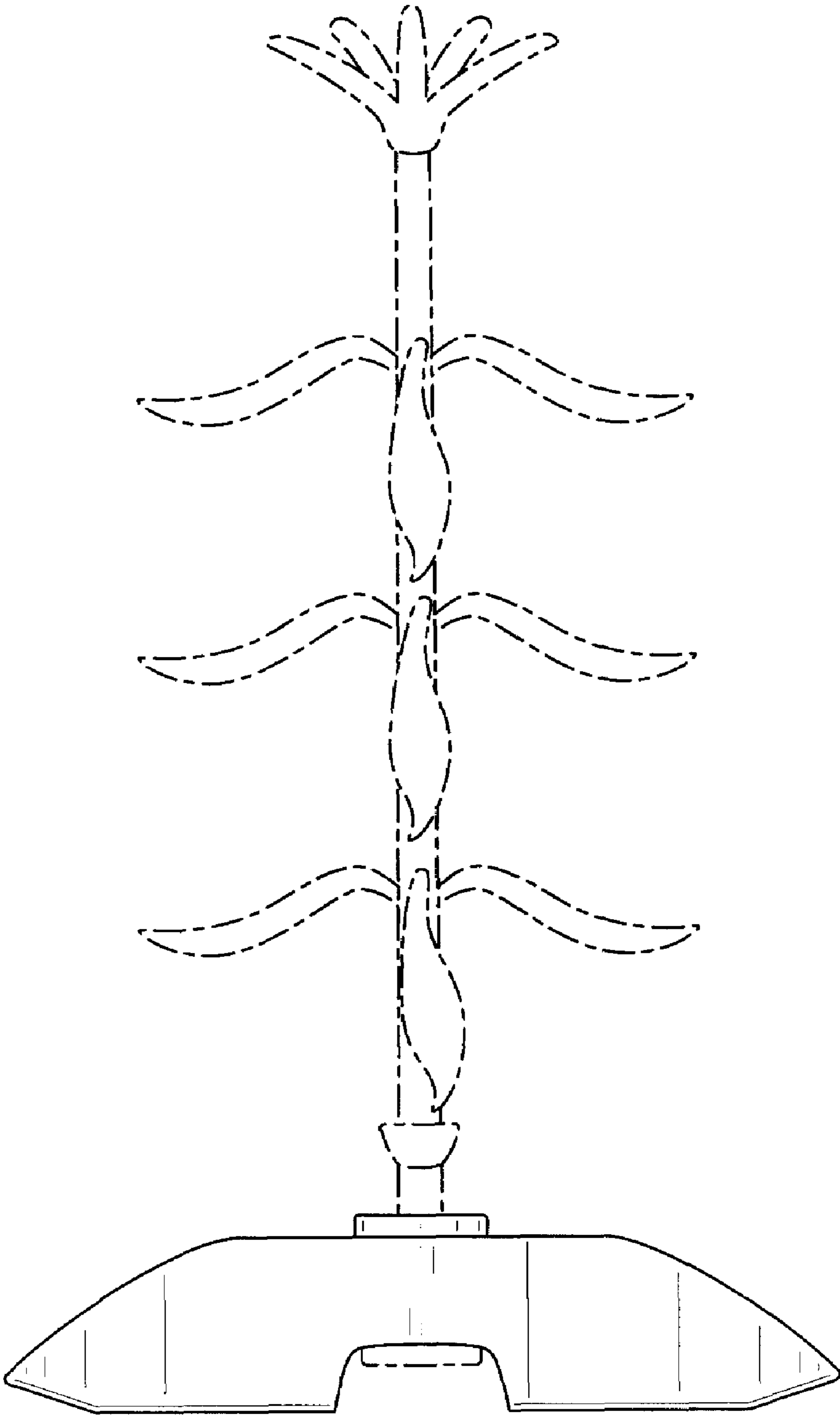

FIG. 2

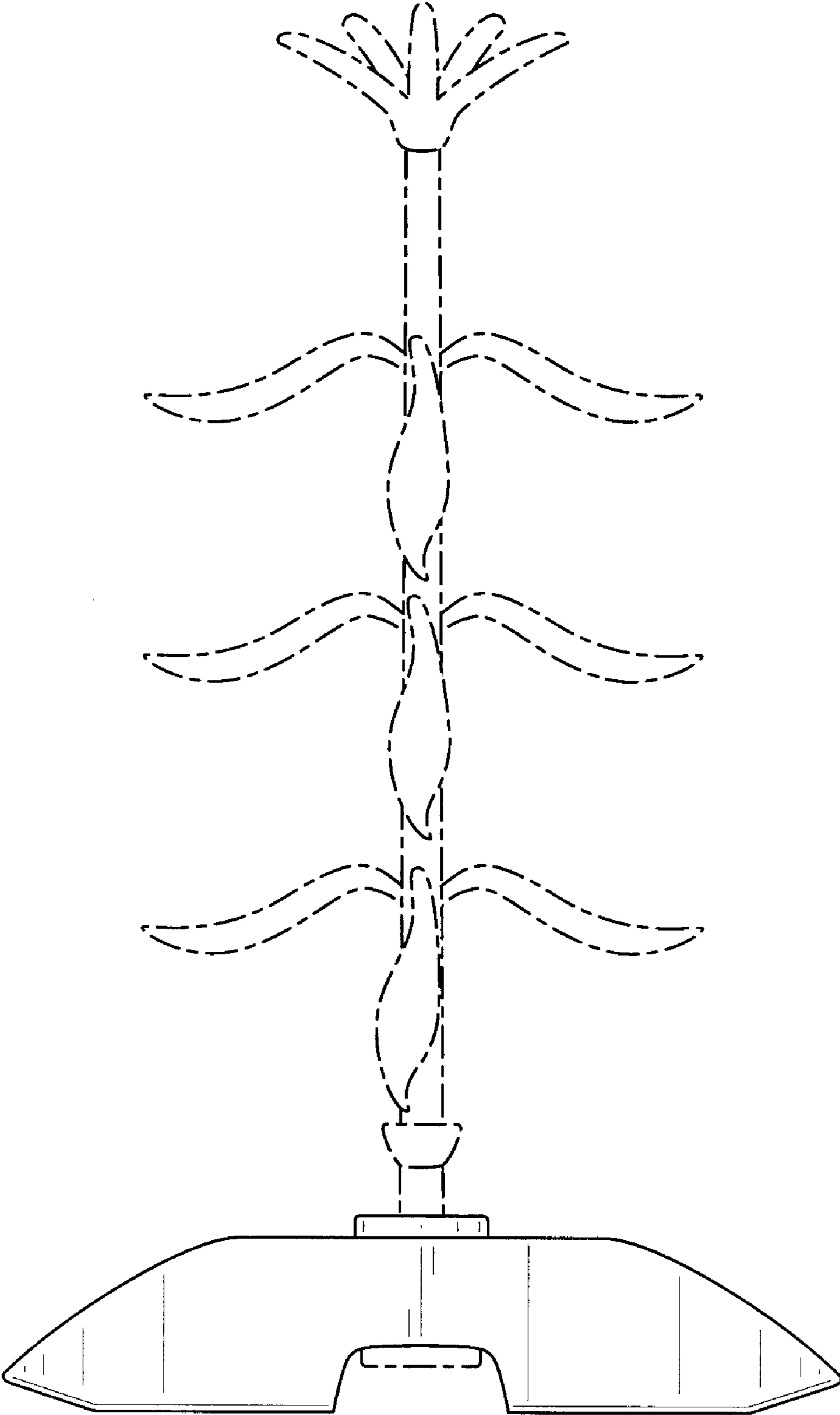

FIG. 3

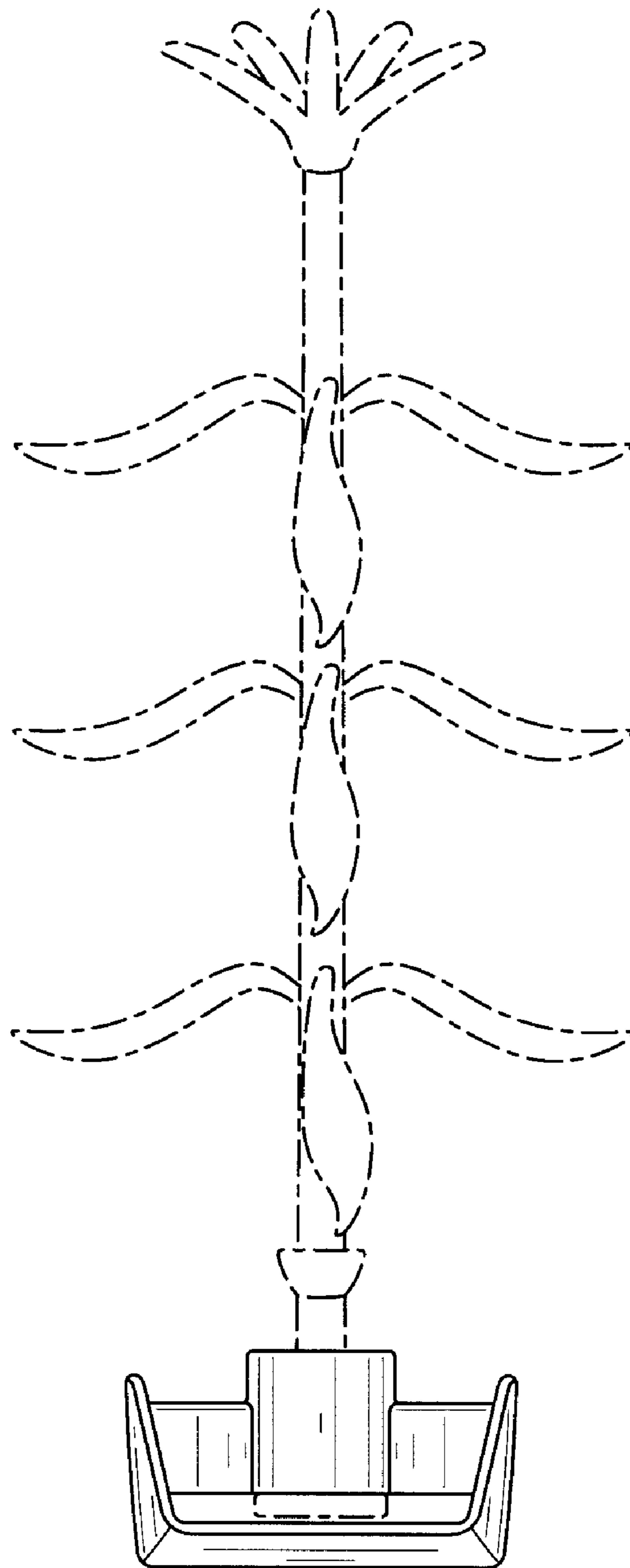

FIG. 4

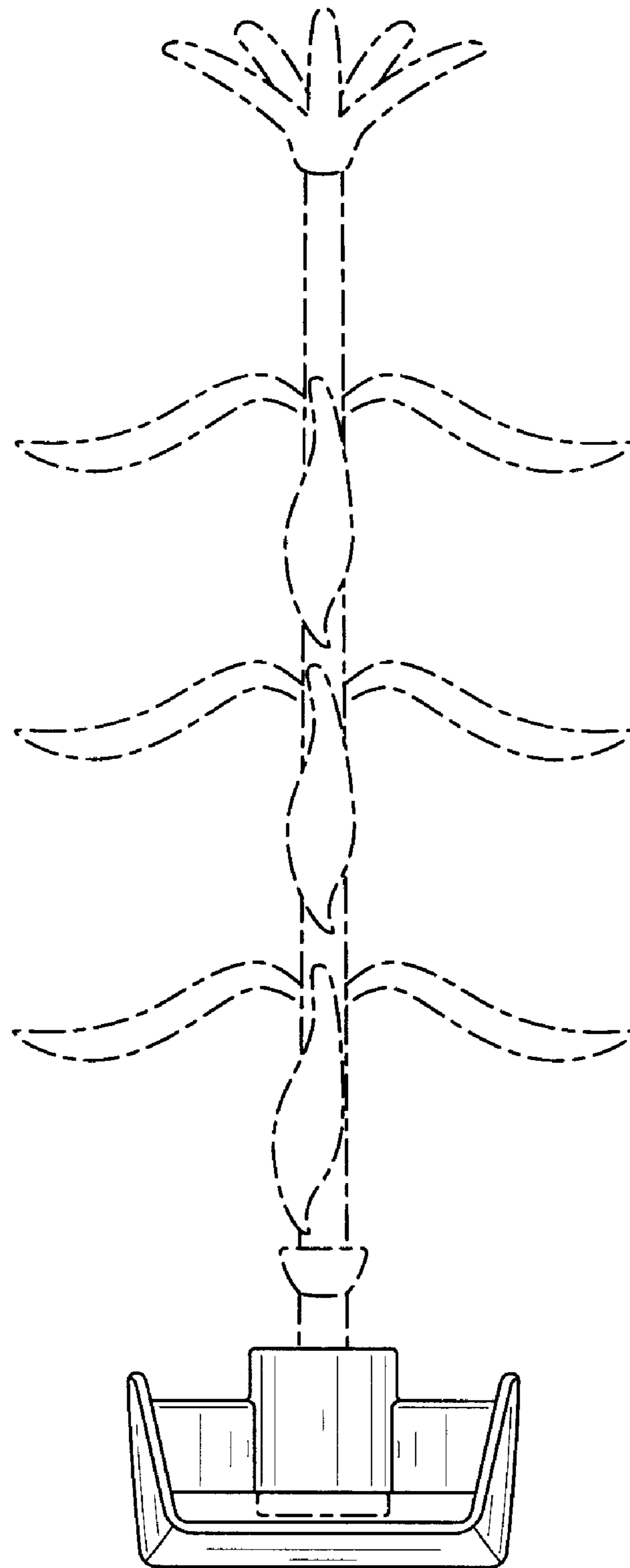

FIG. 5

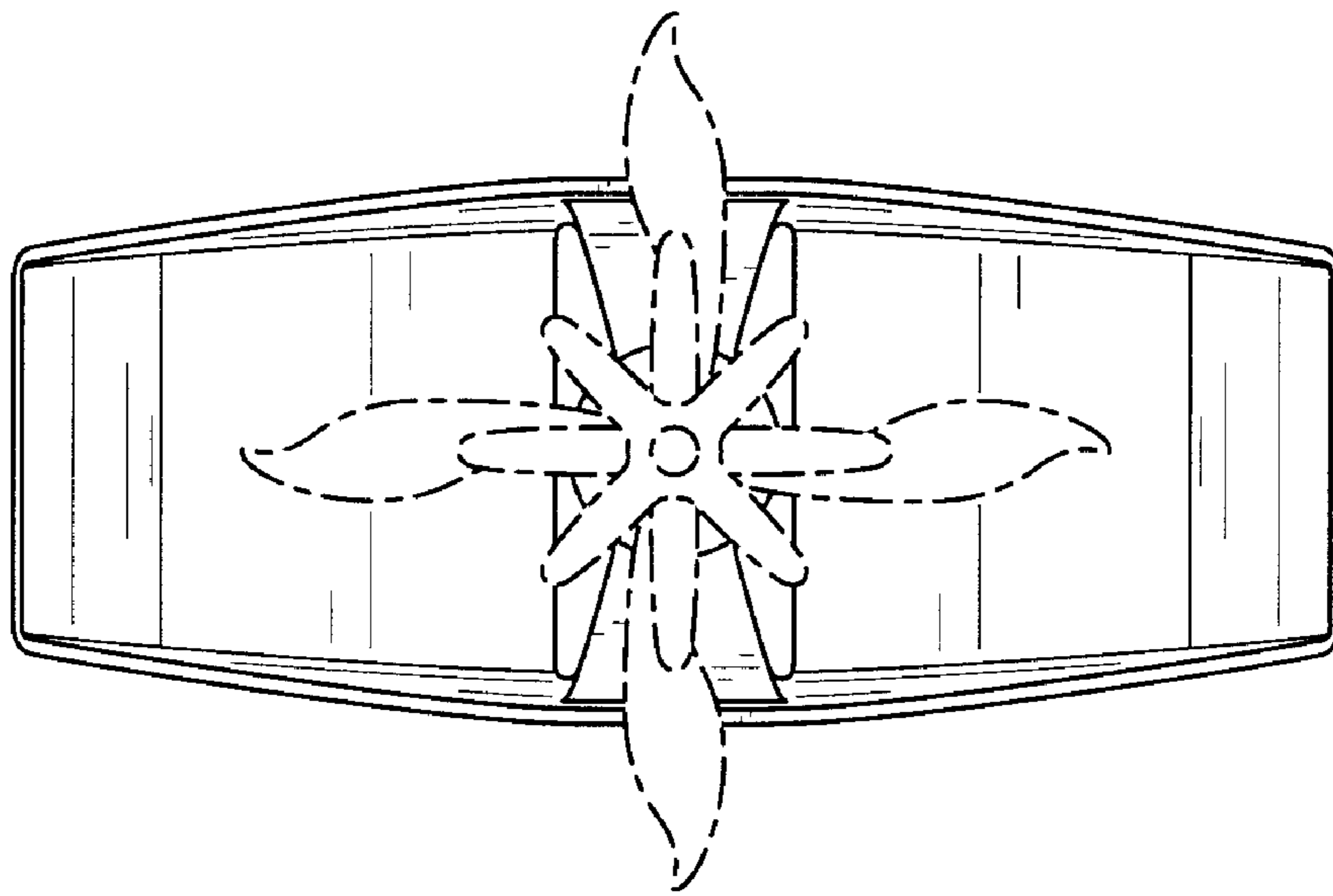

FIG. 6

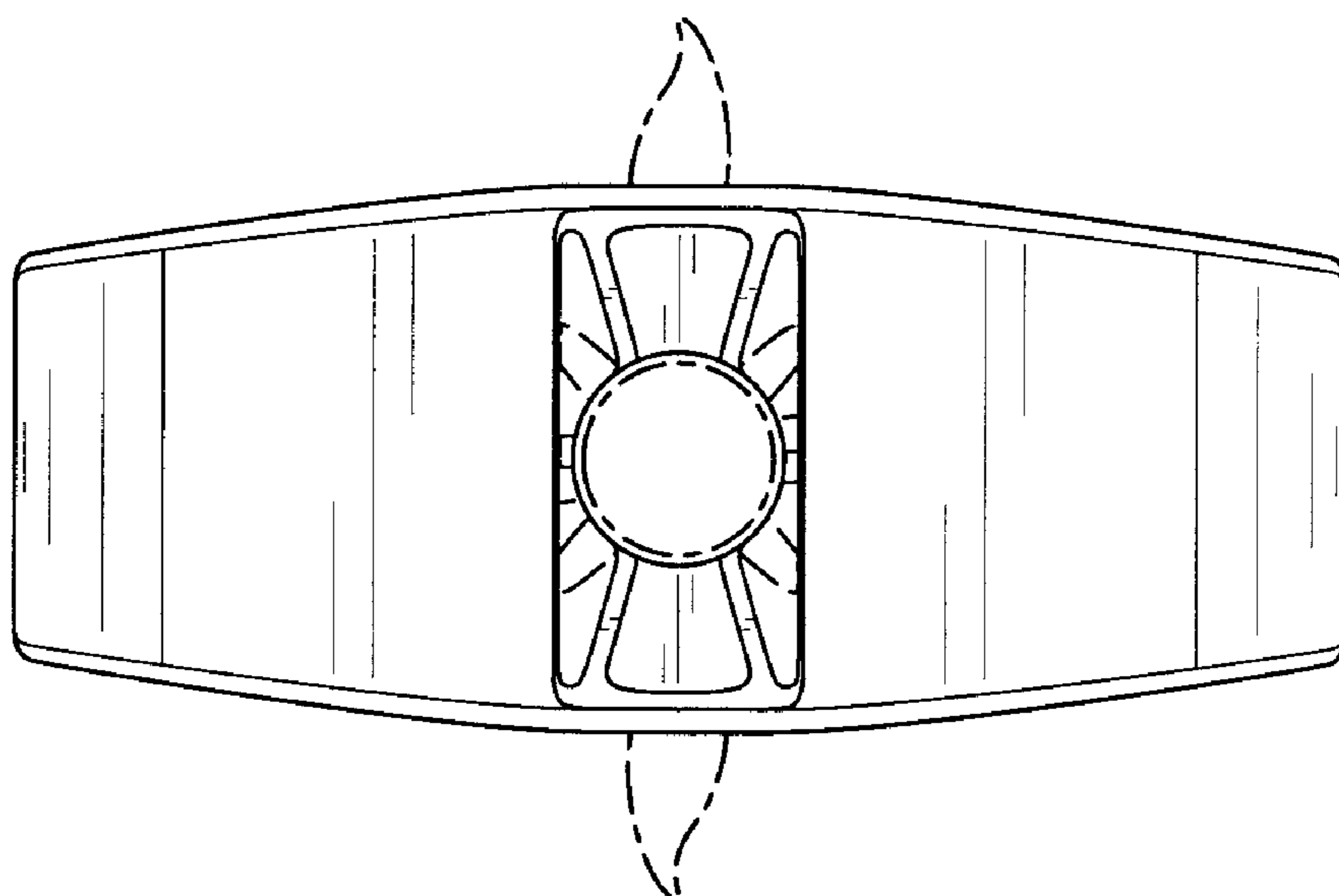

FIG. 7