

US00D565318S

(12) **United States Design Patent**  
**Alter Molina et al.**

(10) **Patent No.:** **US D565,318 S**  
(45) **Date of Patent:** **\*\* Apr. 1, 2008**

(54) **CHAIR**

(75) Inventors: **Lievore Alter Molina**, Barcelona (ES);  
**Rodolfo Dordoni**, Milan (IT); **Claudio Feltrin**, Treviso (IT)

(73) Assignee: **Arper S.p.A.**, Monastier di Treviso (IT)

(\*\*) Term: **14 Years**

(21) Appl. No.: **29/271,303**

(22) Filed: **Jan. 16, 2007**

**Related U.S. Application Data**

(62) Division of application No. 29/216,745, filed on Nov. 8, 2004.

(30) **Foreign Application Priority Data**

May 14, 2004 (EM) ..... 183918

(51) **LOC (8) Cl.** ..... **06-01**

(52) **U.S. Cl.** ..... **D6/375**

(58) **Field of Classification Search** ..... D6/375,  
D6/334-335, 339, 360, 364-367, 371-373,  
D6/379, 380, 498, 500-502; 297/411.2,  
297/41.23, 411.24, 411.25, 411.27, 411.28,  
297/452.3, 452.11, 452.12, 452.14, 452.29

See application file for complete search history.

(56) **References Cited**

**U.S. PATENT DOCUMENTS**

D258,176 S \* 2/1981 Baker ..... D6/360

D420,821 S \* 2/2000 Barile et al. .... D6/360  
D429,077 S \* 8/2000 Lin ..... D6/360  
D436,748 S \* 1/2001 Noll ..... D6/360  
D468,918 S \* 1/2003 de Blois ..... D6/360

\* cited by examiner

*Primary Examiner*—Robert M. Spear

*Assistant Examiner*—Katrina A Kile

(74) *Attorney, Agent, or Firm*—Scully, Scott, Murphy & Presser, P.C.

(57) **CLAIM**

The ornamental design for a chair, as shown and described.

**DESCRIPTION**

FIG. 1 is a front and side perspective view of the chair, showing our new design;

FIG. 2 is a front view thereof;

FIG. 3 is a rear view thereof;

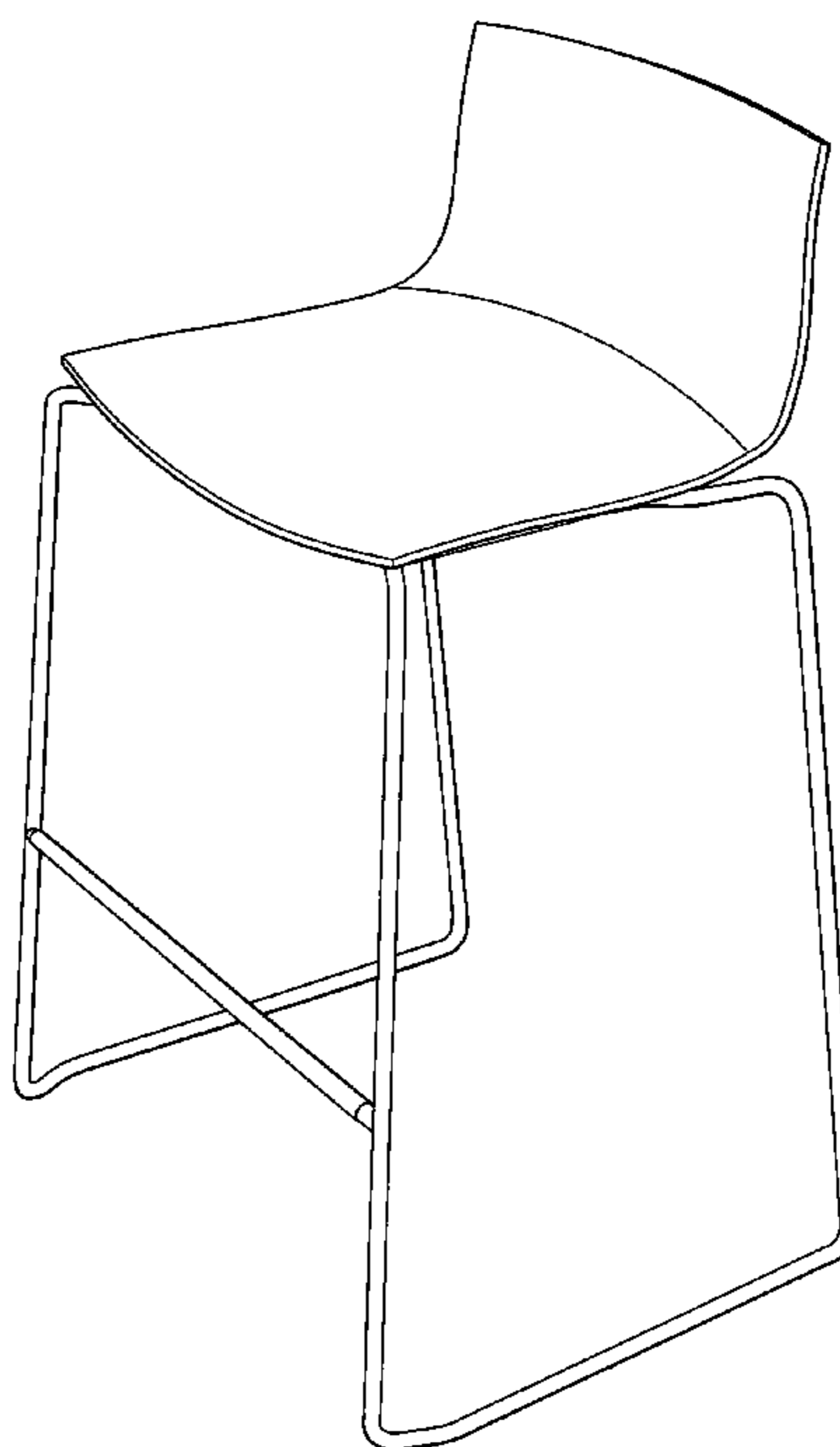
FIG. 4 is a left side view thereof;

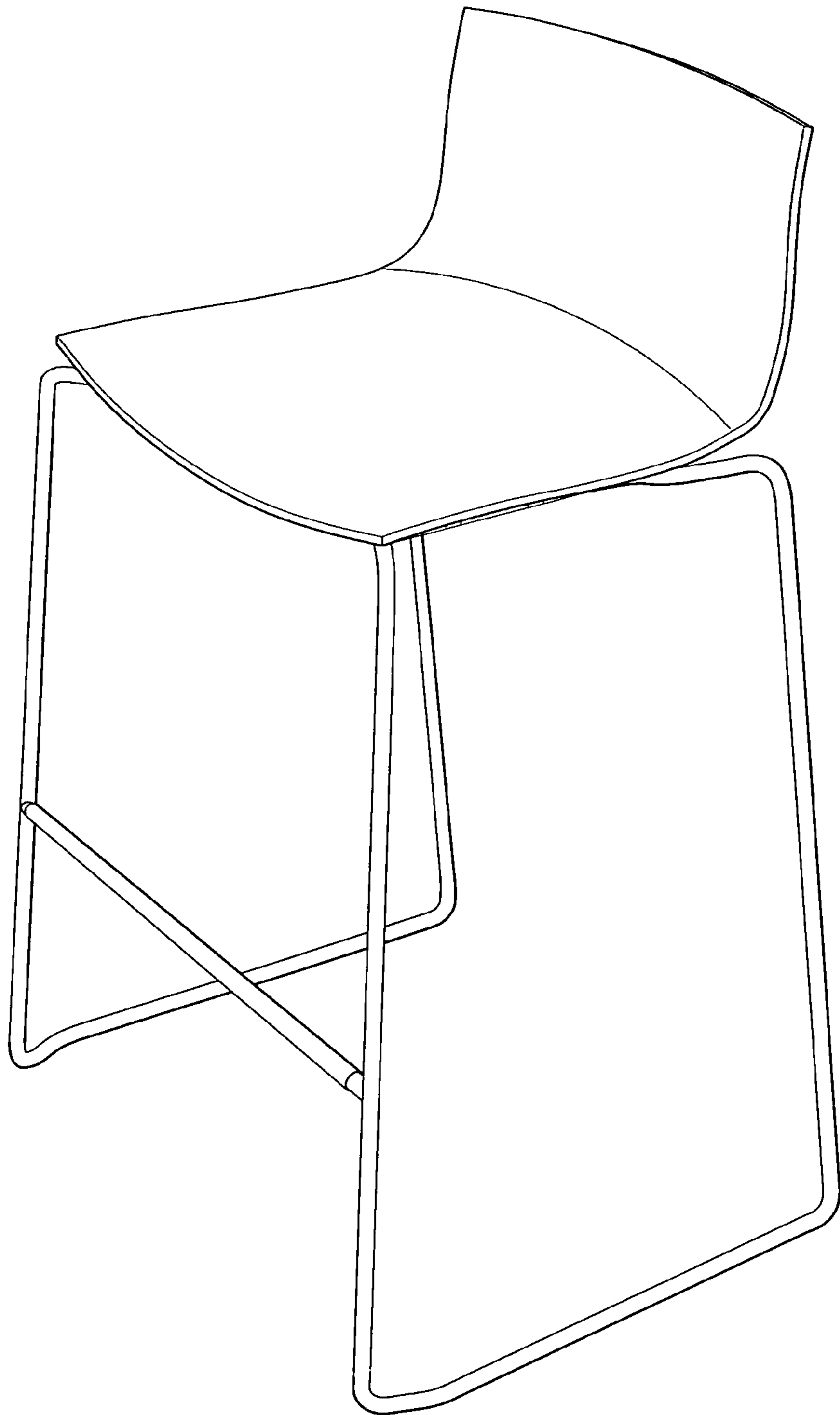
FIG. 5 is a right side view thereof;

FIG. 6 is a top view thereof; and,

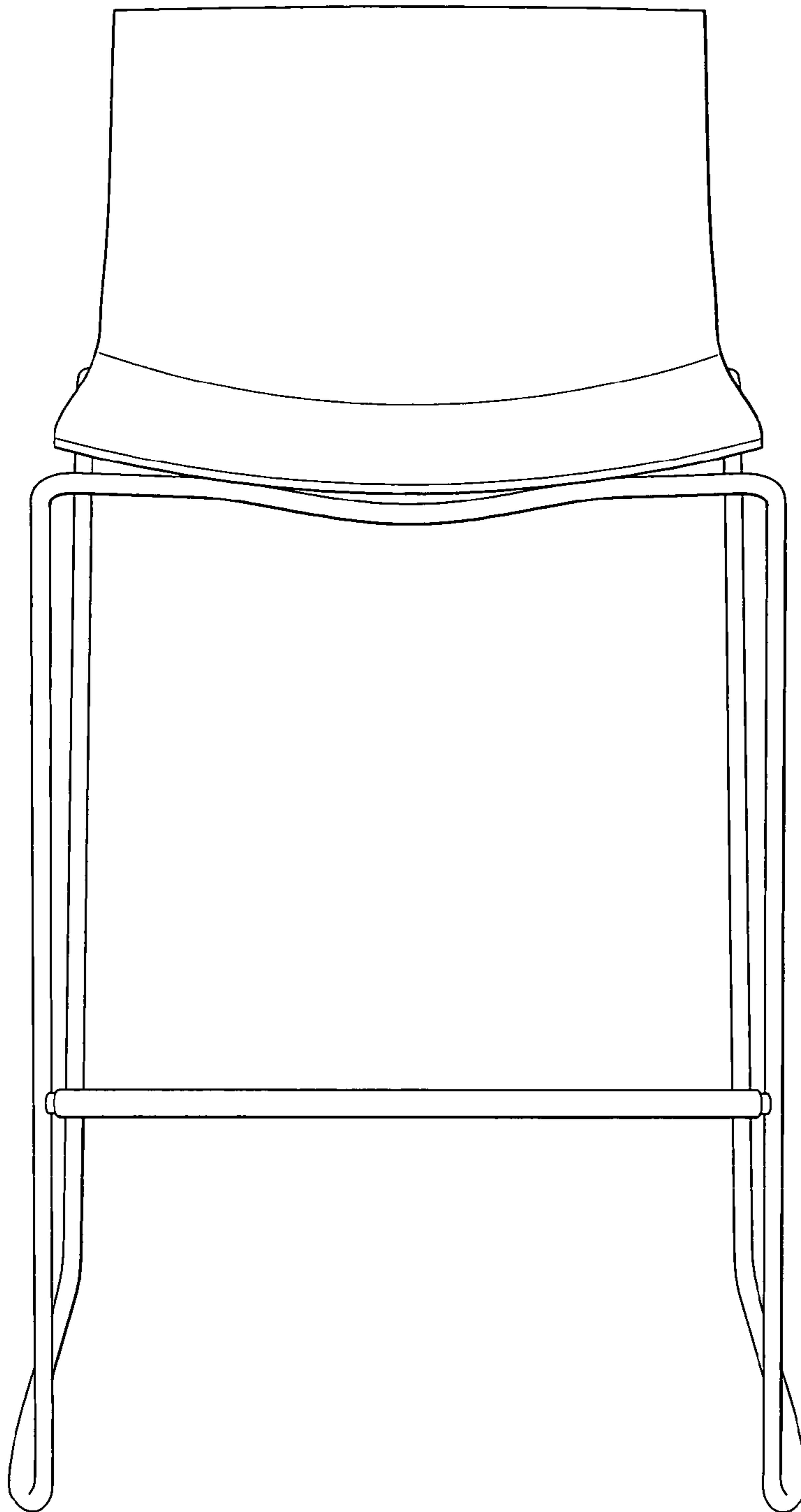
FIG. 7 is a bottom view thereof.

**1 Claim, 7 Drawing Sheets**

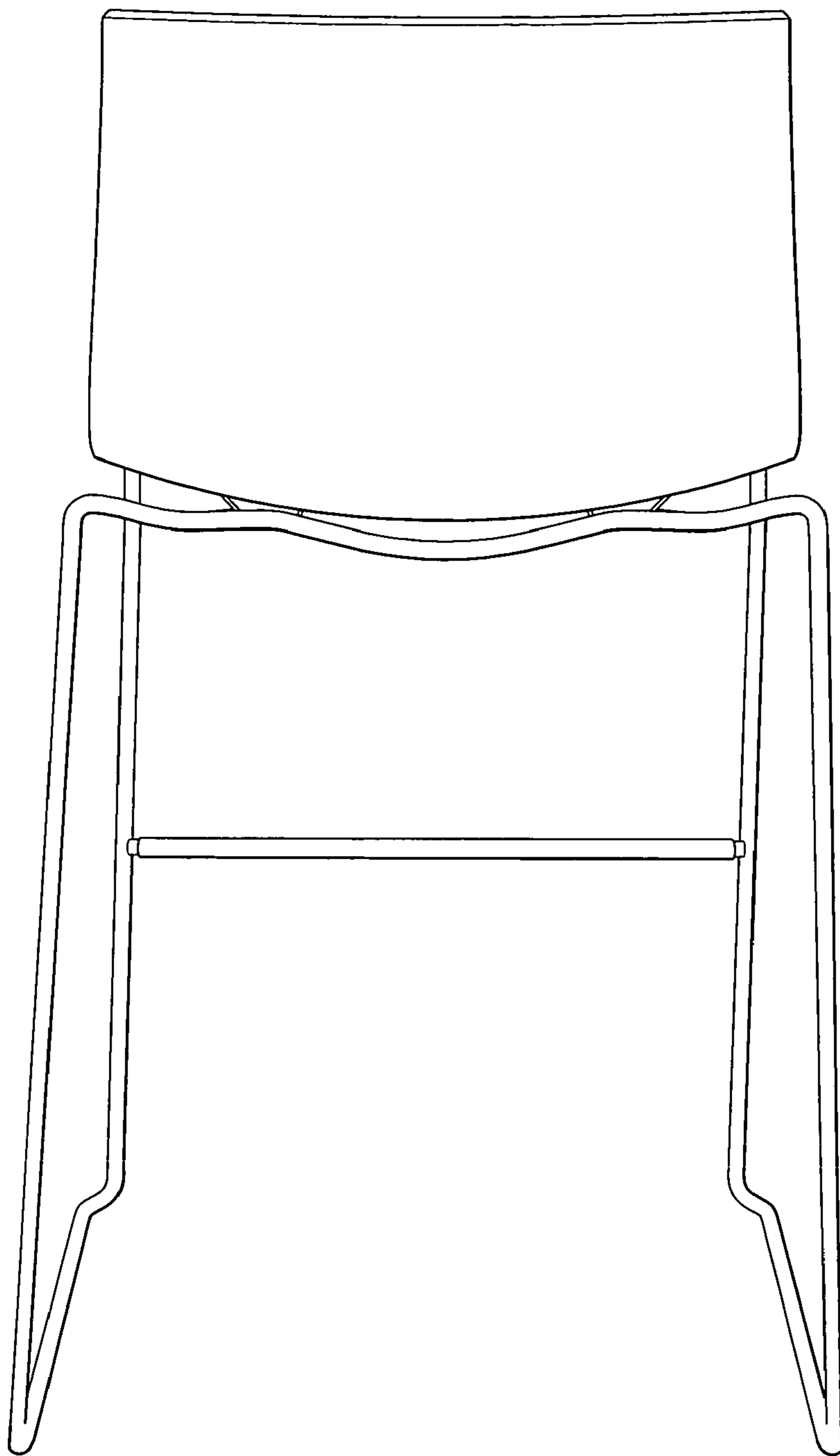




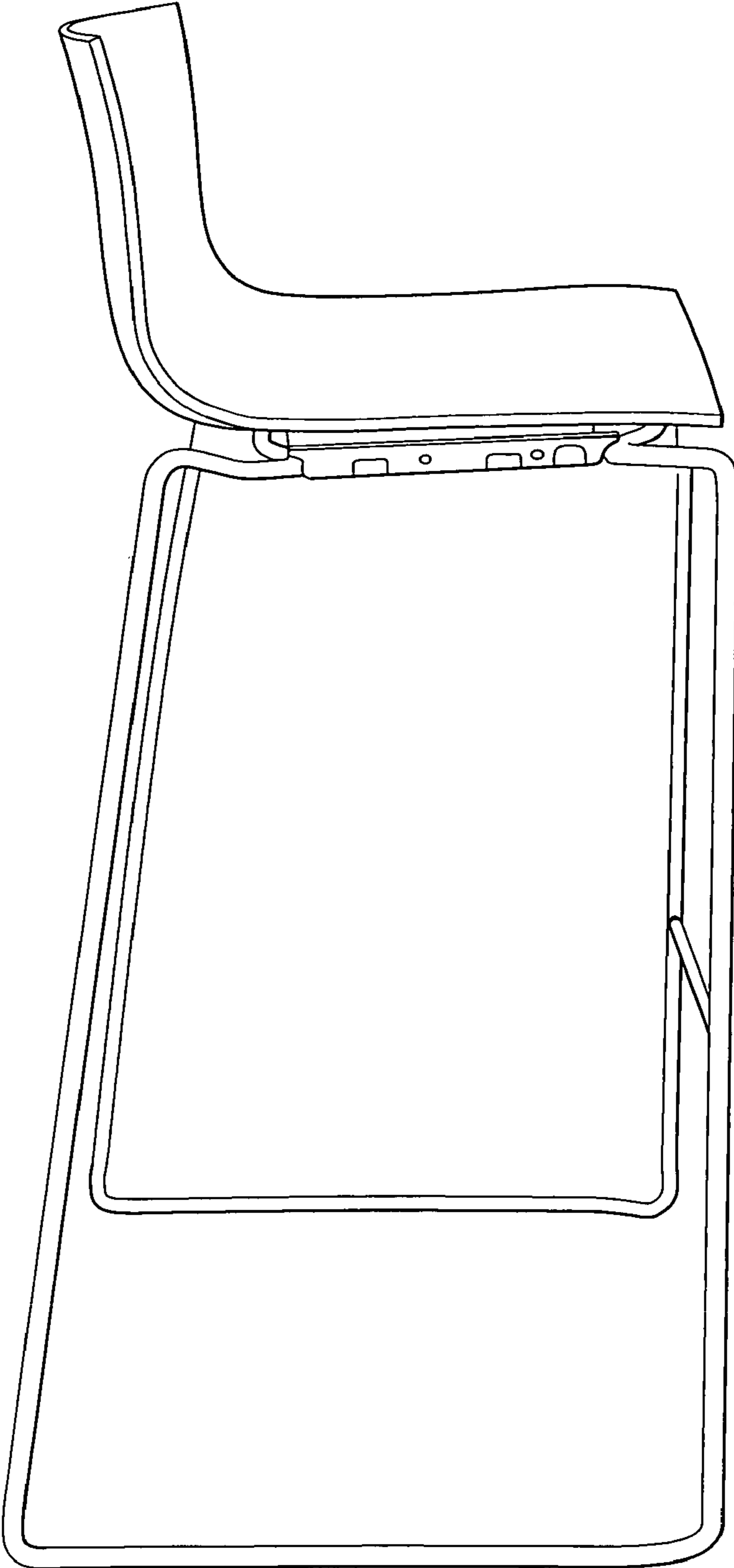
*Fig. 1*



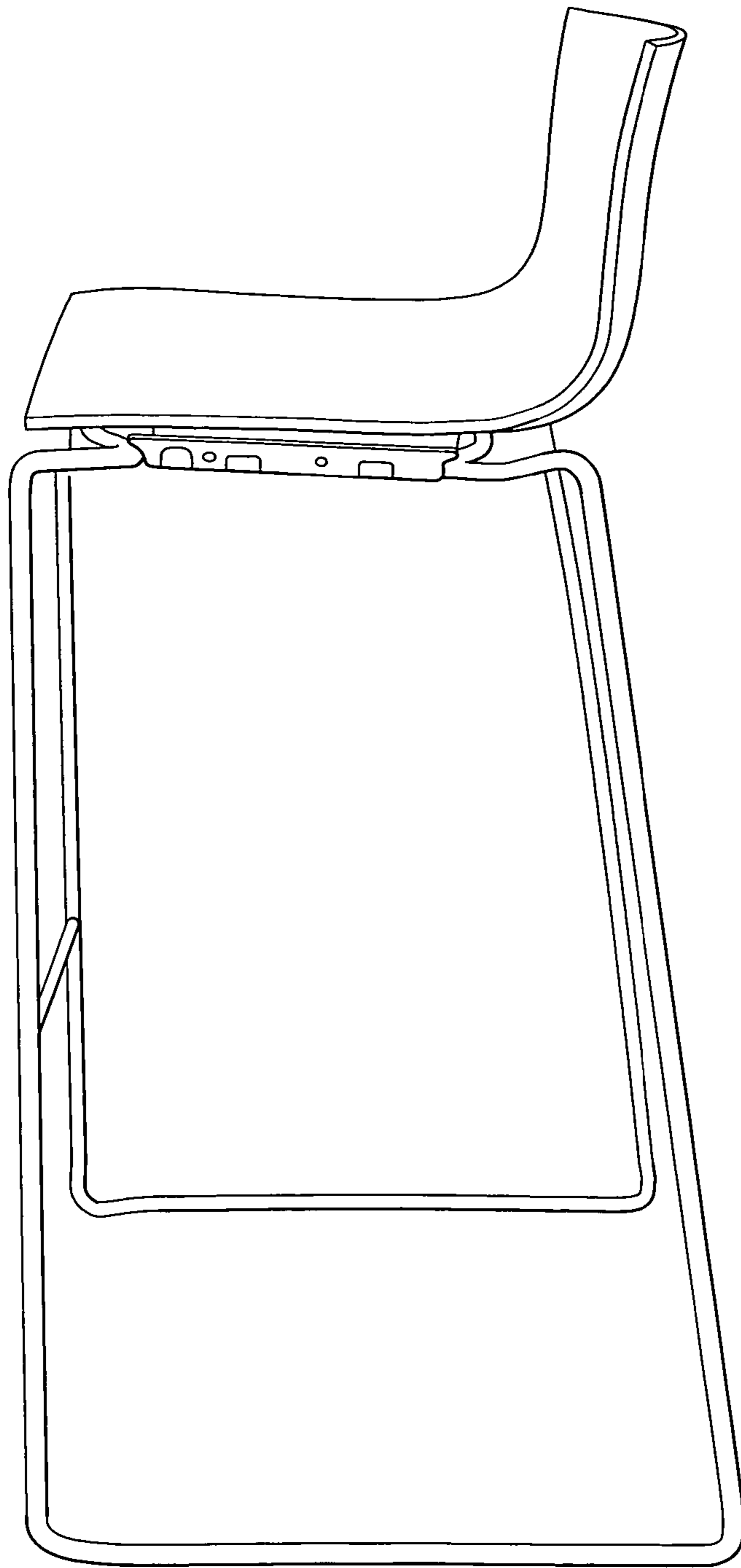
*Fig. 2*



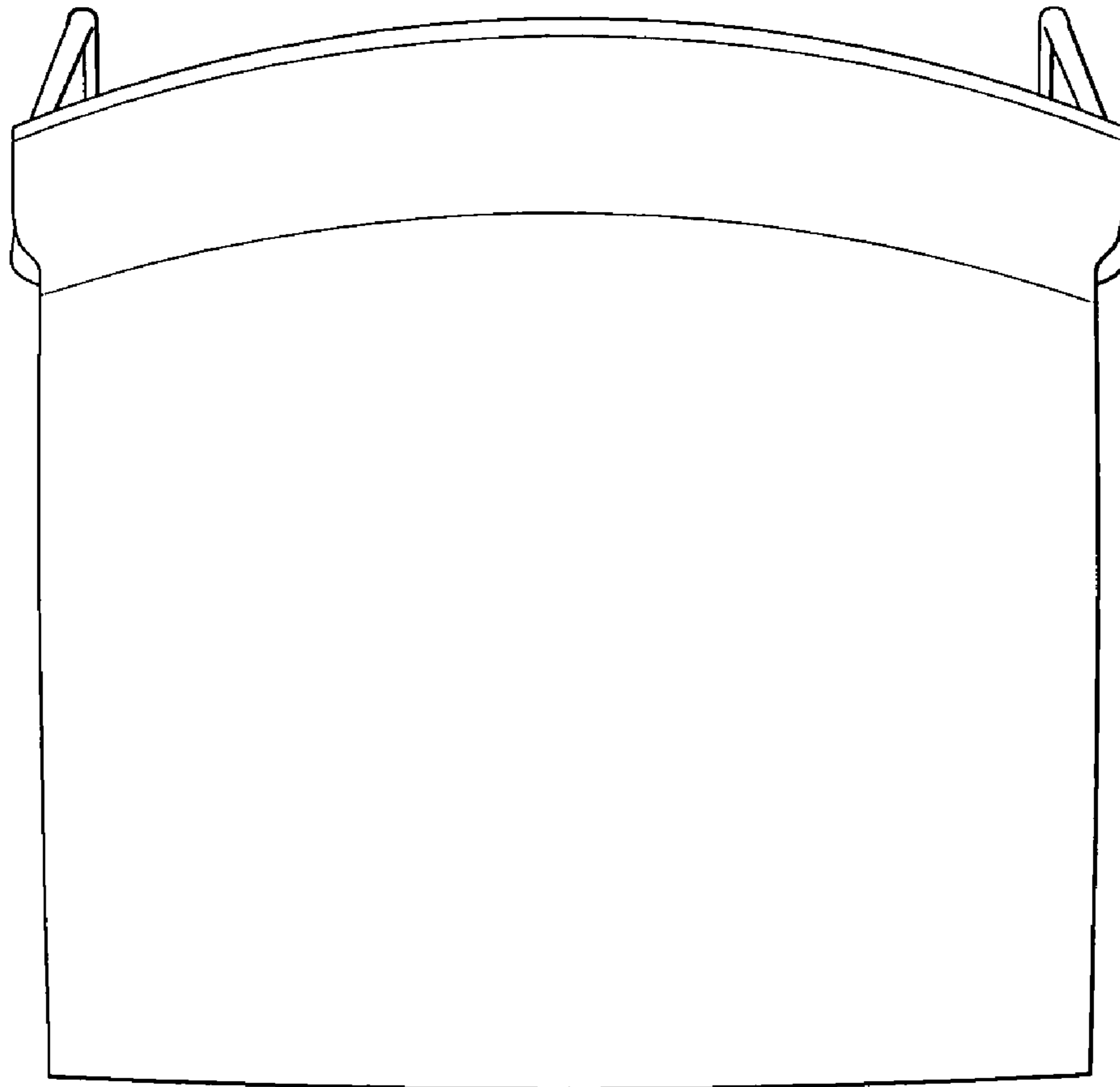
*Fig. 3*



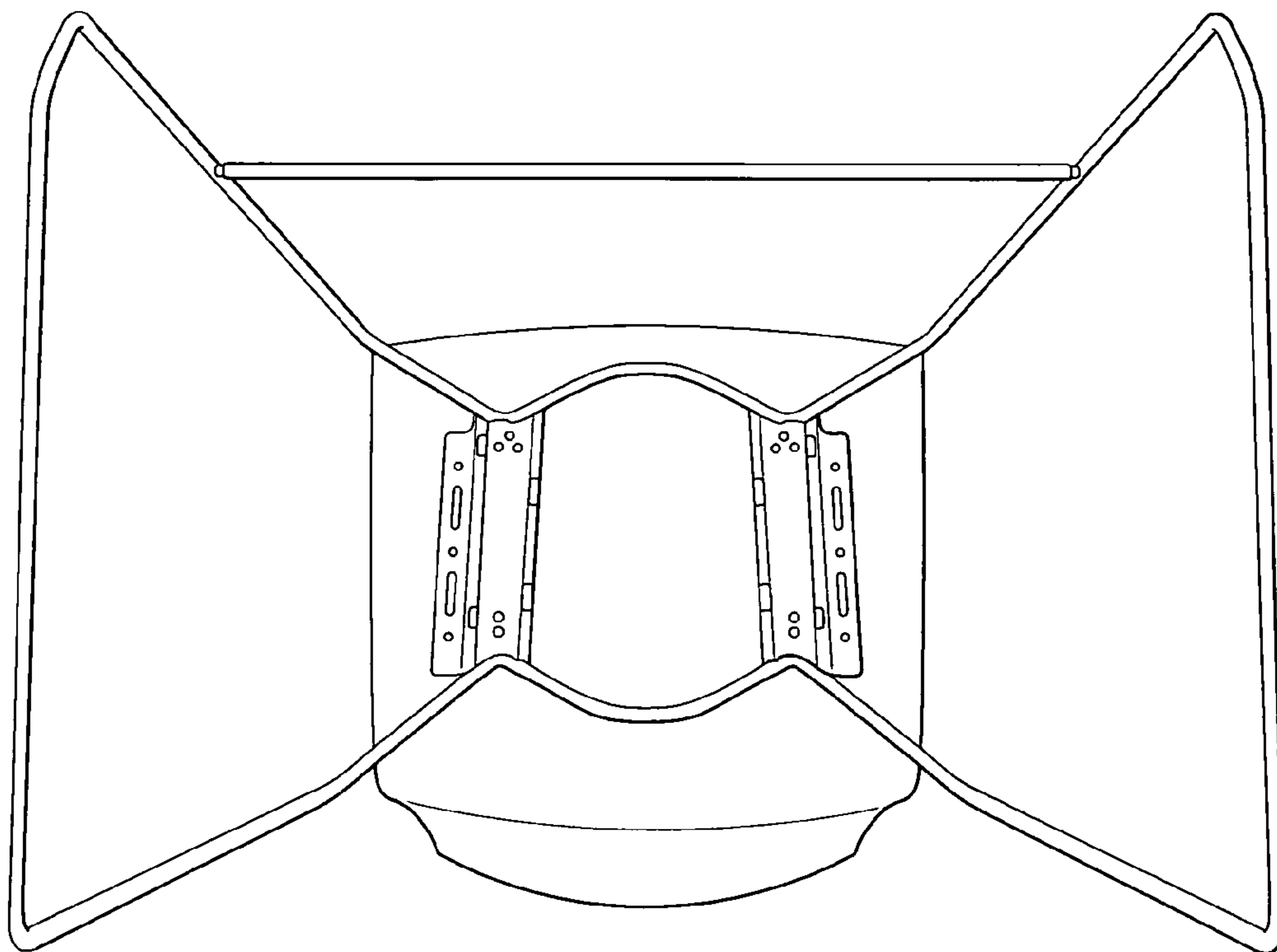
*Fig. 4*



*Fig. 5*



*Fig. 6*



*Fig. 7*