



US00D565317S

(12) **United States Design Patent**
Molina et al.

(10) **Patent No.:** **US D565,317 S**
(45) **Date of Patent:** **** Apr. 1, 2008**

(54) **CHAIR**

(75) Inventors: **Lievore Alter Molina**, Barcelona (ES);
Rodolfo Dordoni, Milan (IT); **Claudio Feltrin**, Treviso (IT)

(73) Assignee: **Arper S.p.A.**, Monastier Di Treviso (IT)

(**) Term: **14 Years**

(21) Appl. No.: **29/271,301**

(22) Filed: **Jan. 16, 2007**

Related U.S. Application Data

(62) Division of application No. 29/216,745, filed on Nov. 8, 2004, now Pat. No. Des. 550,466.

(30) **Foreign Application Priority Data**

May 14, 2004 (EM) 183918

(51) **LOC (8) Cl.** **06-01**

(52) **U.S. Cl.** **D6/375; D6/366**

(58) **Field of Classification Search** D6/375,
D6/334-335, 339, 360, 364-367, 371-373,
D6/379, 380, 498, 500-502; 297/411.2,
297/41.23, 411.24, 411.25, 411.27, 411.28,
297/452.3, 452.11, 452.12, 452.14, 452.29
See application file for complete search history.

(56) **References Cited**

U.S. PATENT DOCUMENTS

D234,383 S * 2/1975 Tacke D6/366
D240,375 S * 7/1976 Buhk D6/366
D241,389 S * 9/1976 Ball D6/366
D241,691 S * 10/1976 Rodriguez D6/366

D459,902 S * 7/2002 Fox D6/365
D460,280 S * 7/2002 Fox D6/365
D518,968 S * 4/2006 Magnani et al. D6/375

* cited by examiner

Primary Examiner—Robert M. Spear

Assistant Examiner—Katrina A Kile

(74) *Attorney, Agent, or Firm*—Scully, Scott, Murphy & Presser, P.C.

(57) **CLAIM**

The ornamental design for a chair, as shown and described.

DESCRIPTION

FIG. 1 is a front and side perspective view of the chair, showing our new design;

FIG. 2 is a front view thereof;

FIG. 3 is a rear view thereof;

FIG. 4 is a left side view thereof;

FIG. 5 is a right side view thereof;

FIG. 6 is a top view thereof;

FIG. 7 is a bottom view thereof;

FIG. 8 is a front and side perspective view of a second embodiment of the chair;

FIG. 9 is a front view thereof;

FIG. 10 is a rear view thereof;

FIG. 11 is a left side view thereof;

FIG. 12 is a right side view thereof;

FIG. 13 is a top view thereof; and,

FIG. 14 is a bottom view thereof.

1 Claim, 14 Drawing Sheets

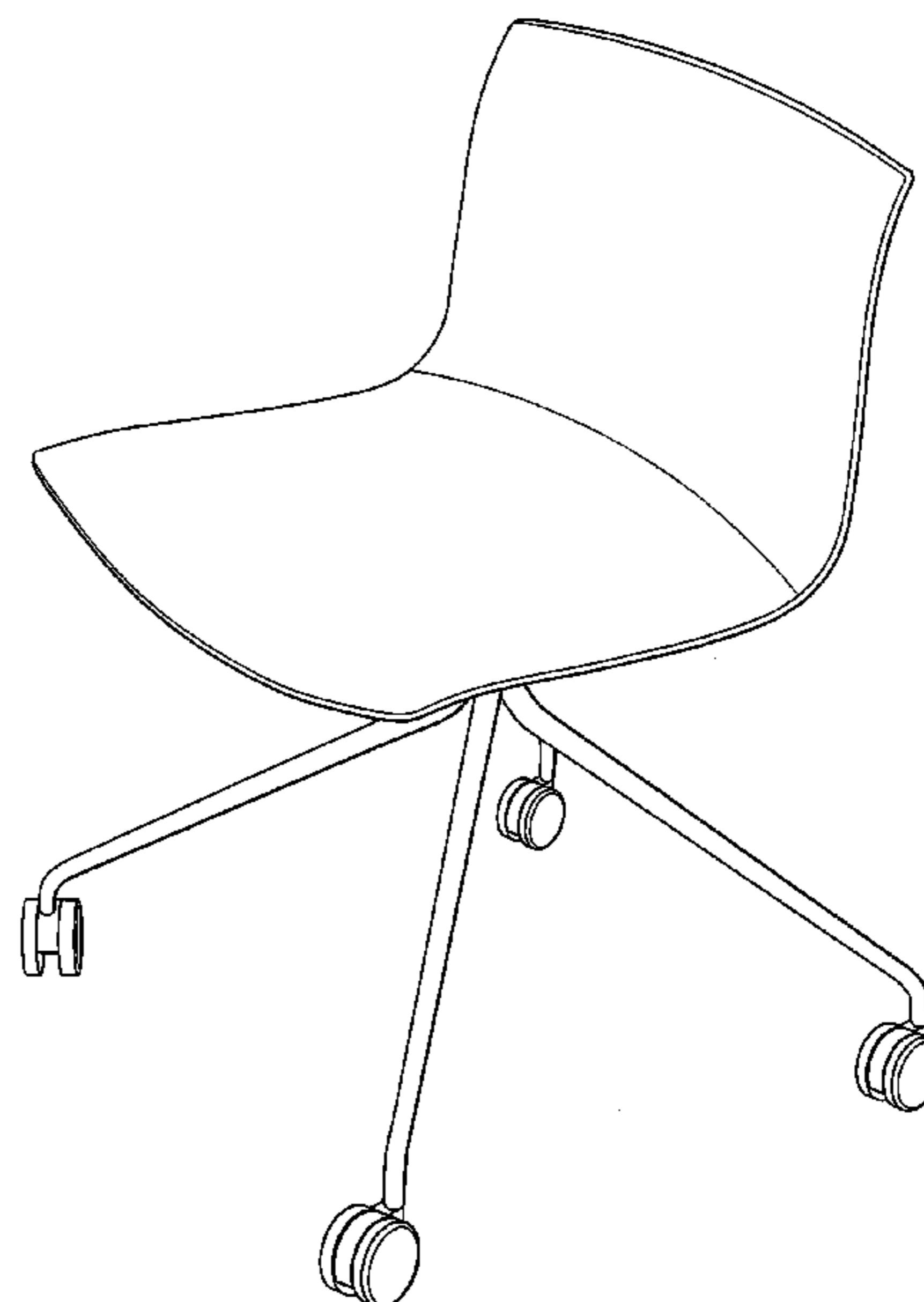
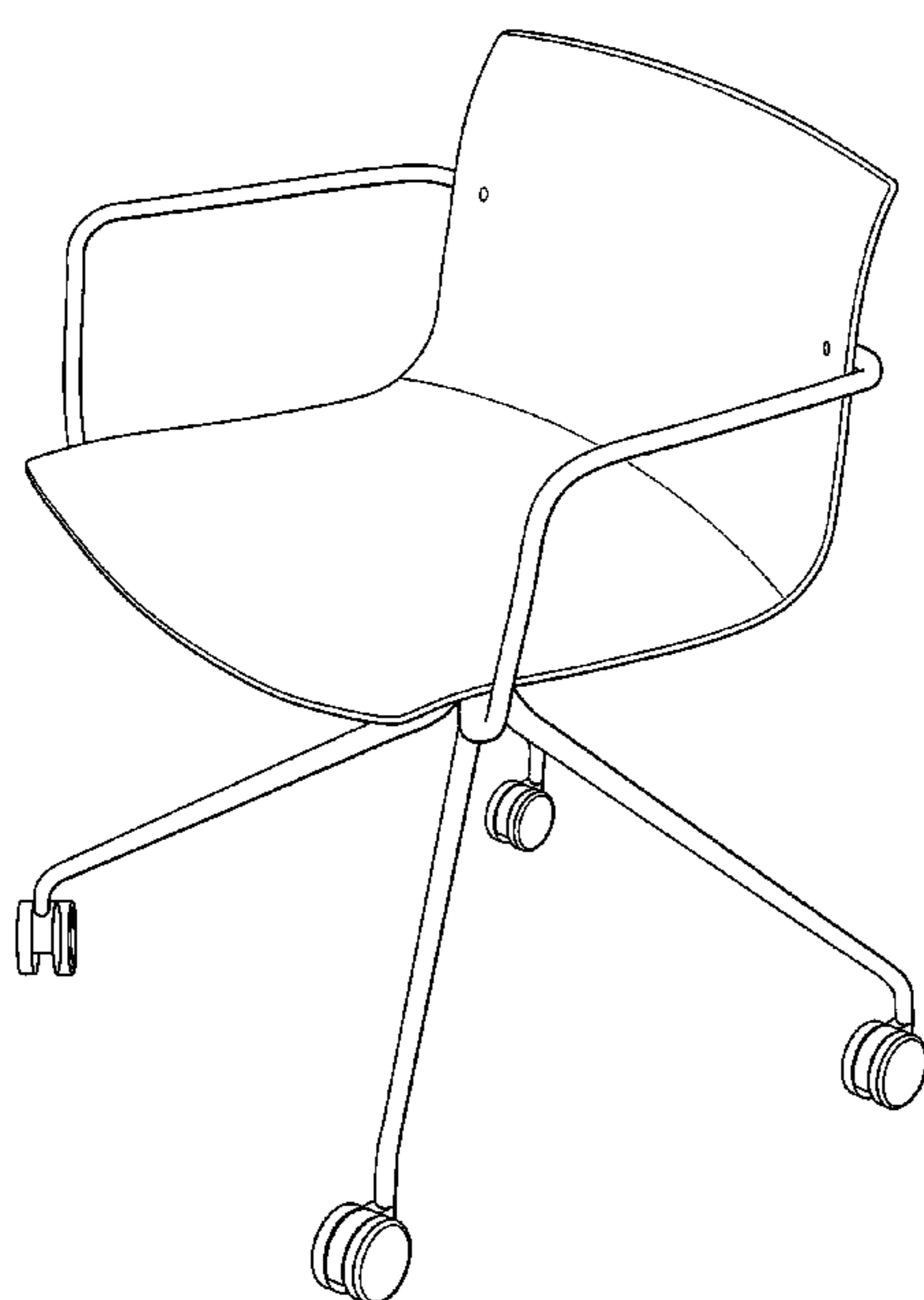

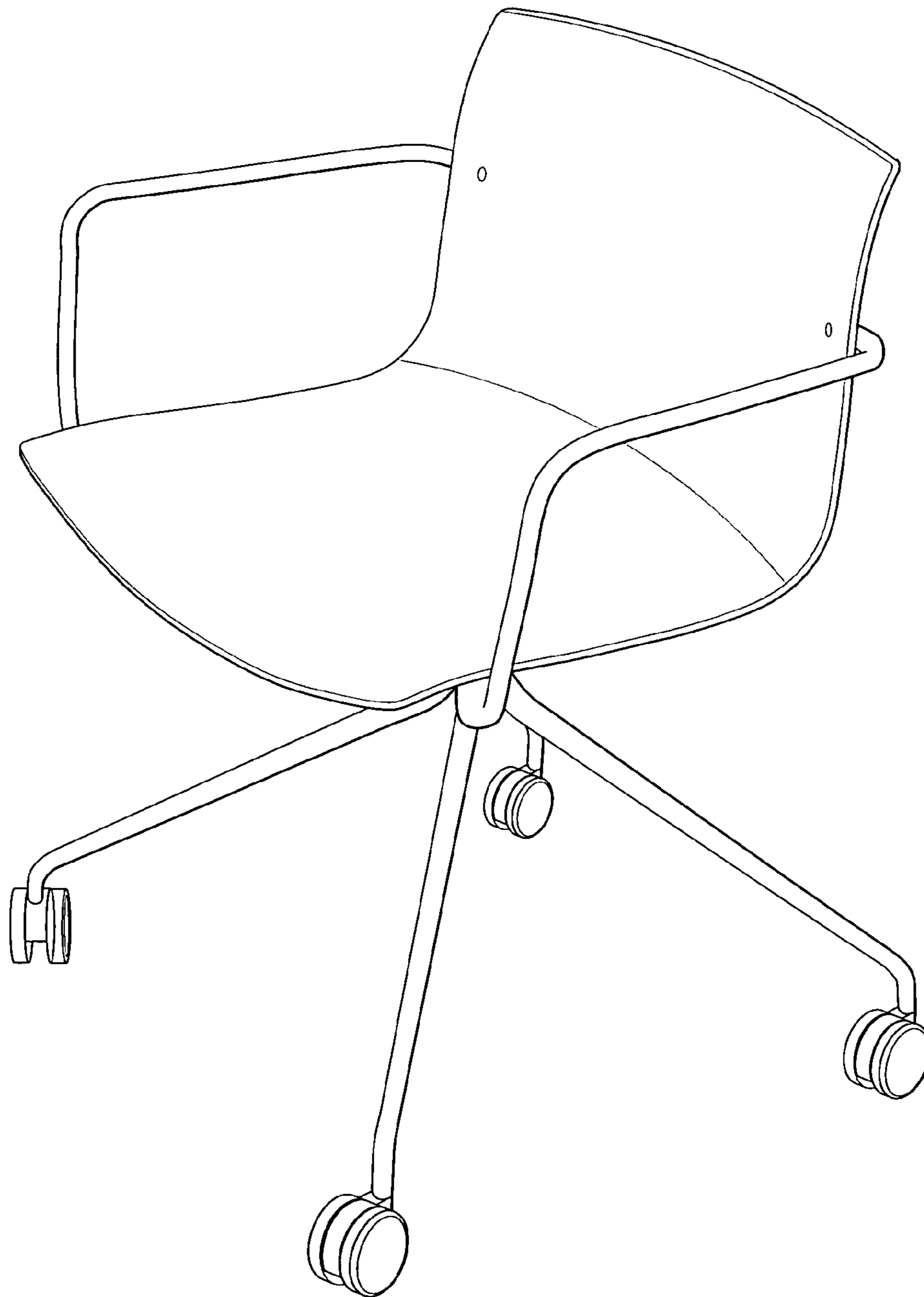

Fig. 1

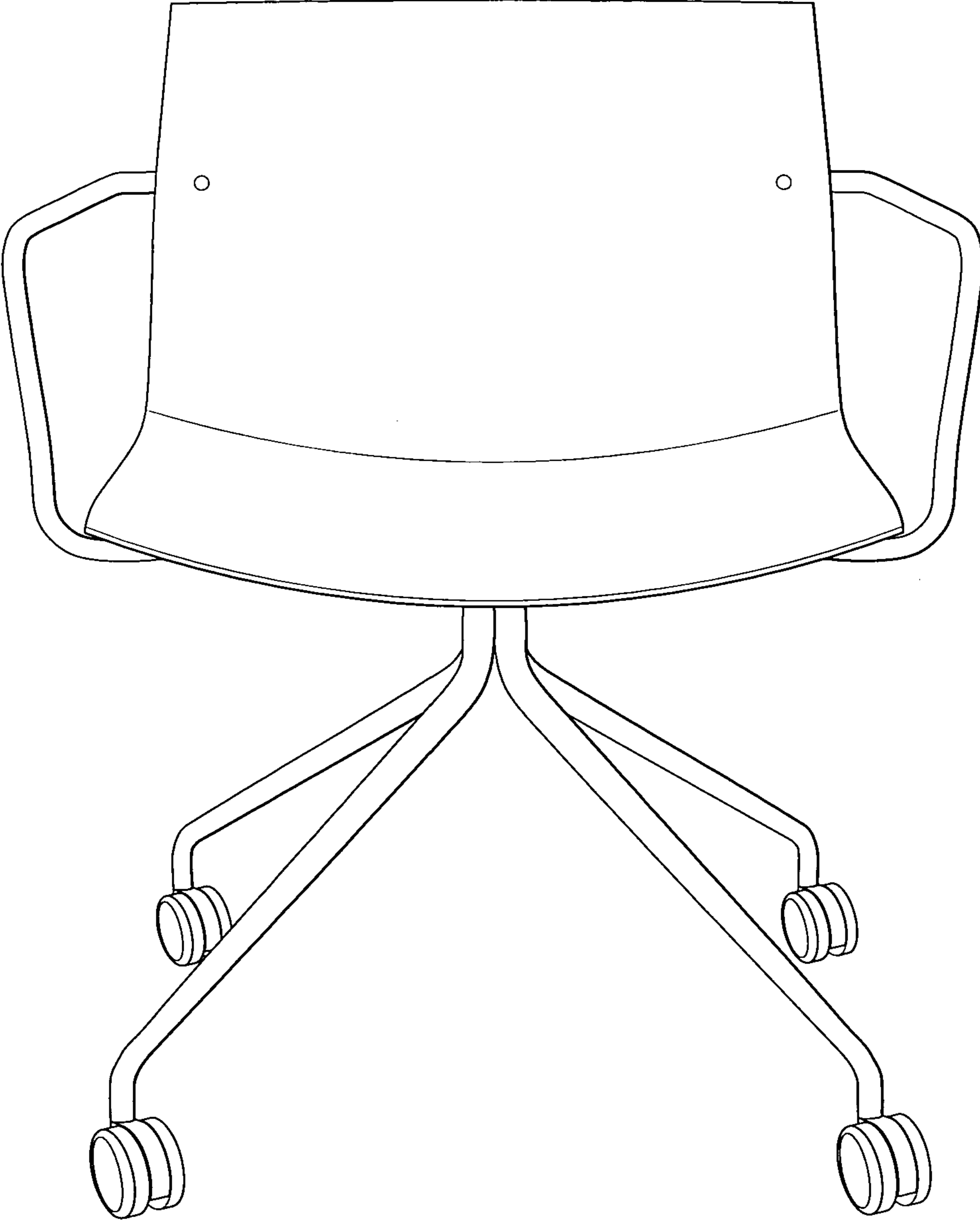

Fig. 2

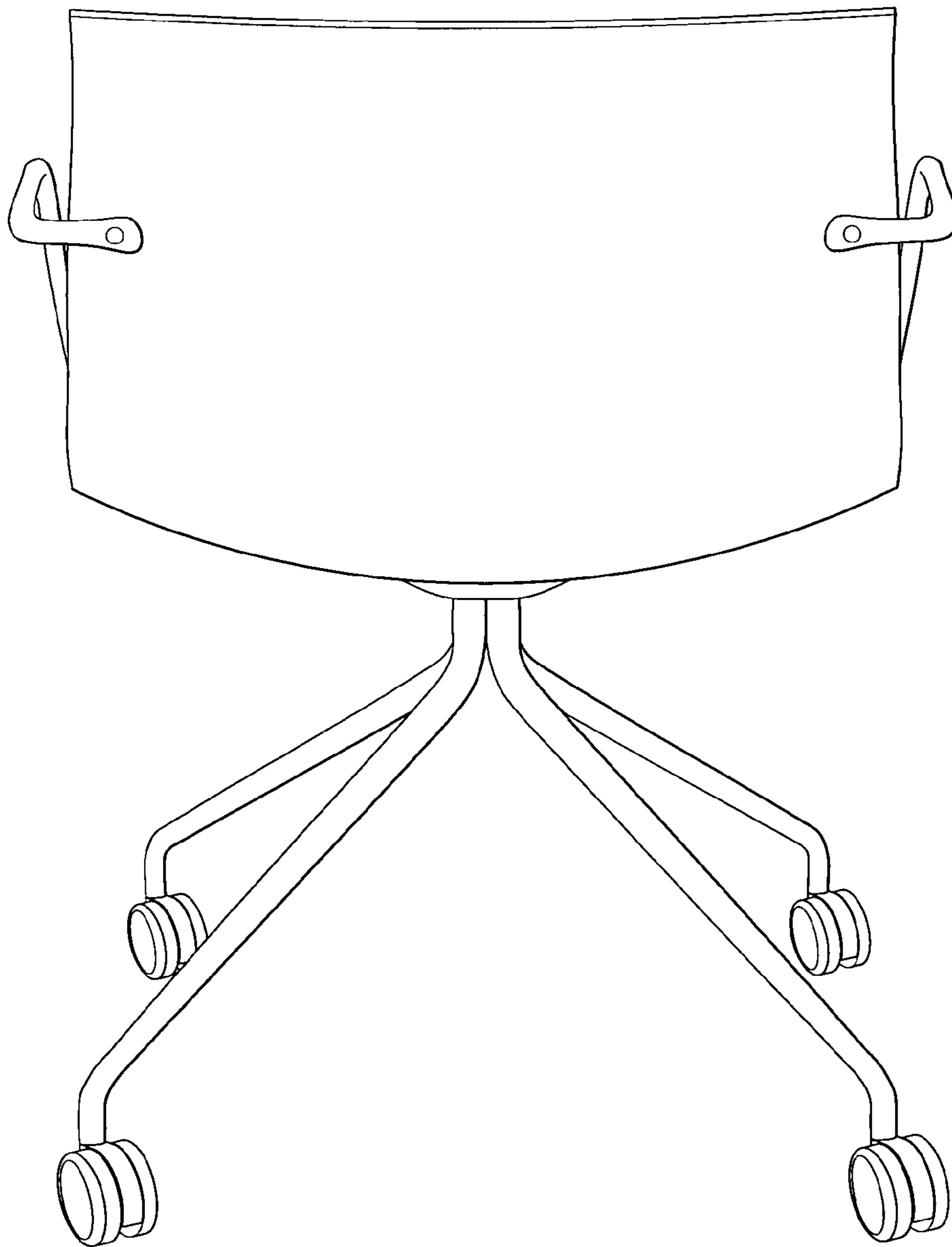

Fig. 3

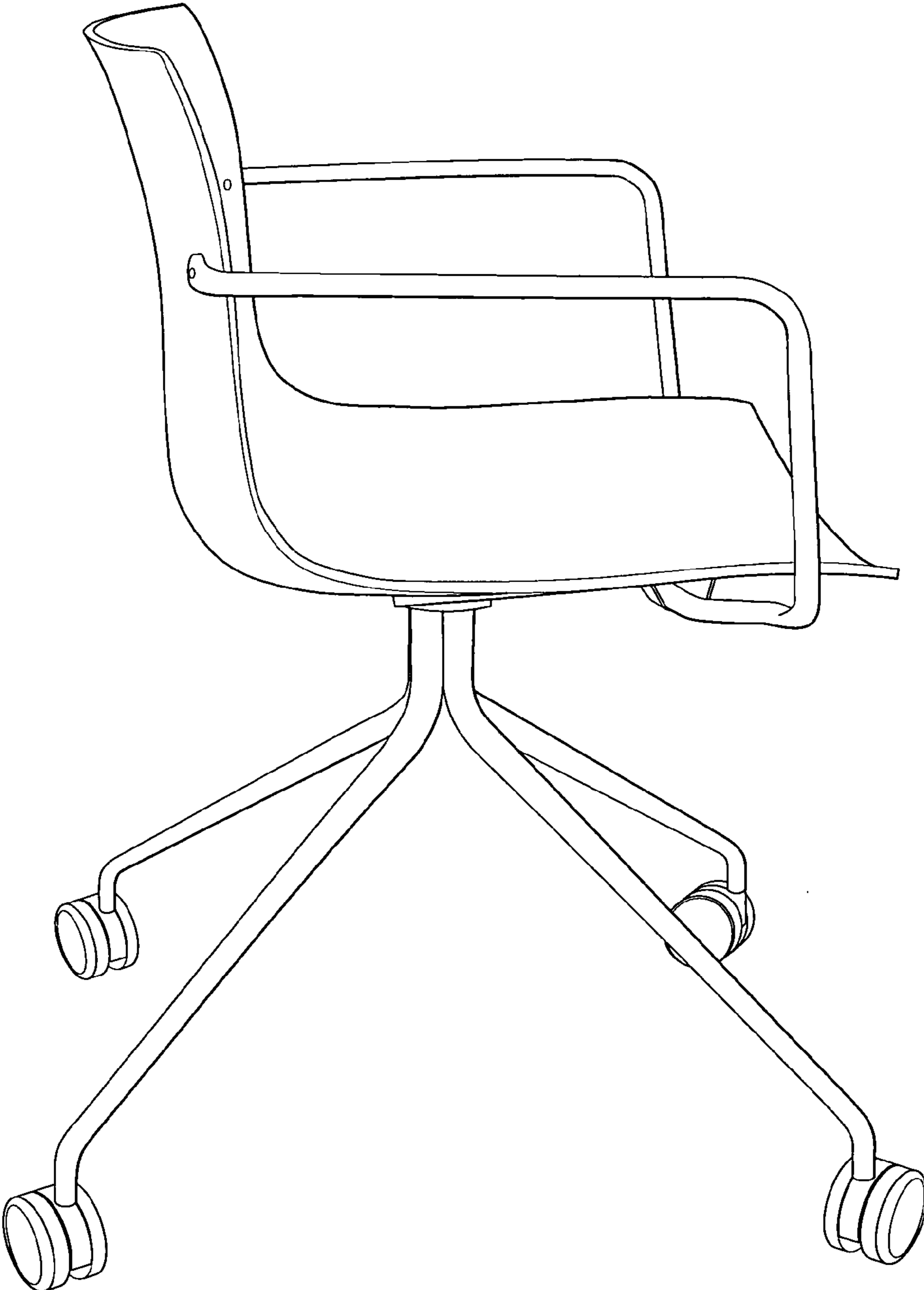

Fig. 4

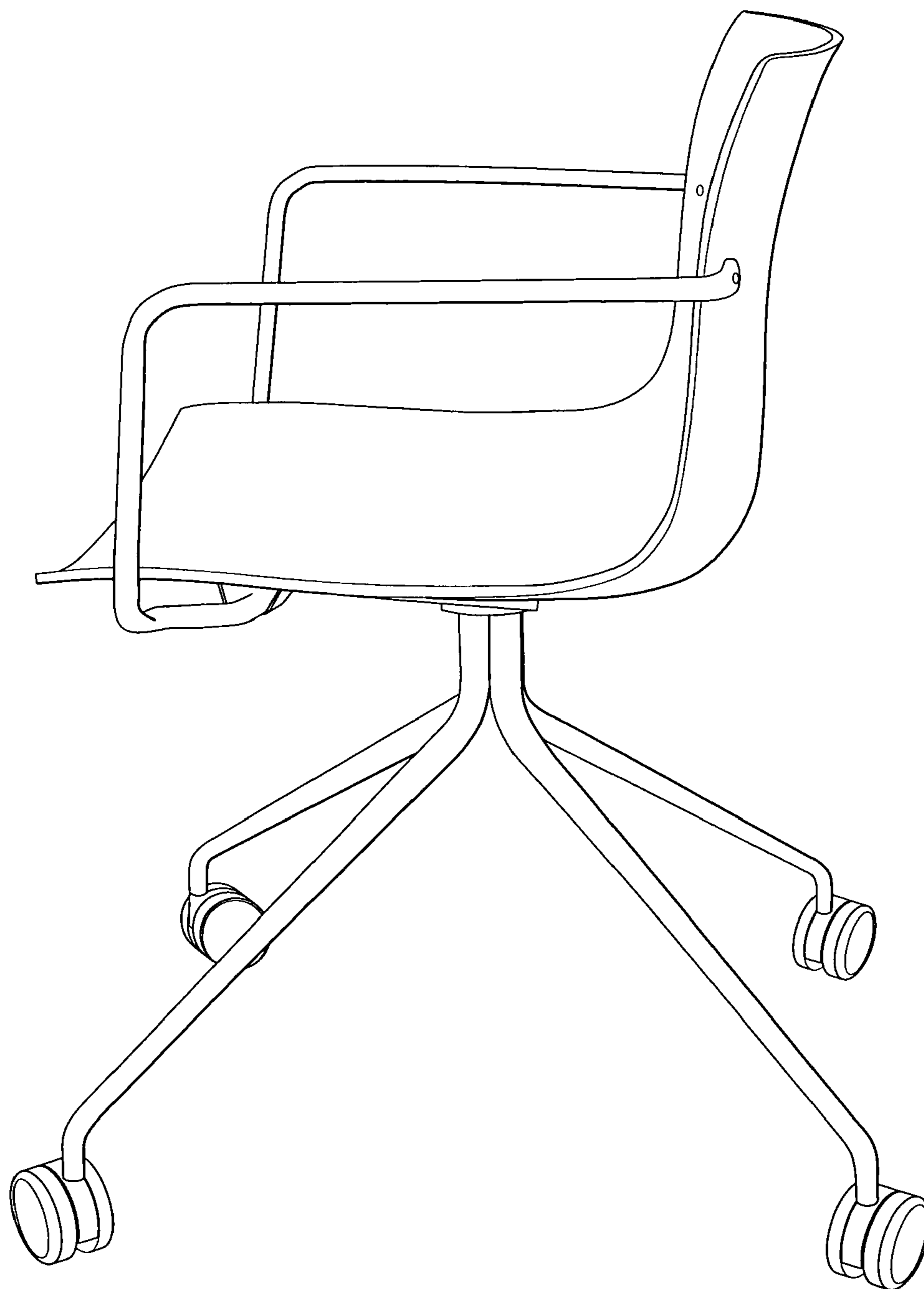

Fig. 5

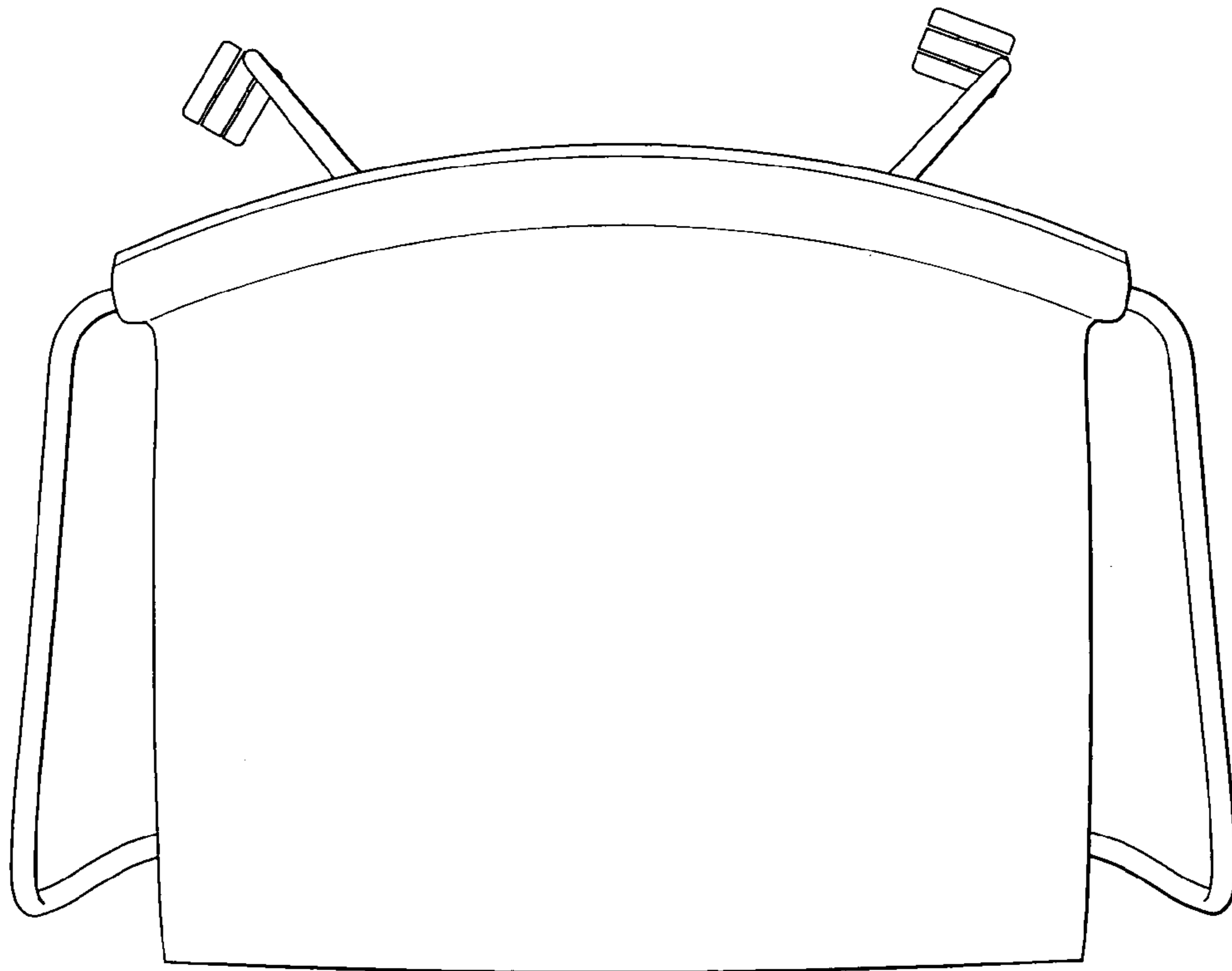

Fig. 6

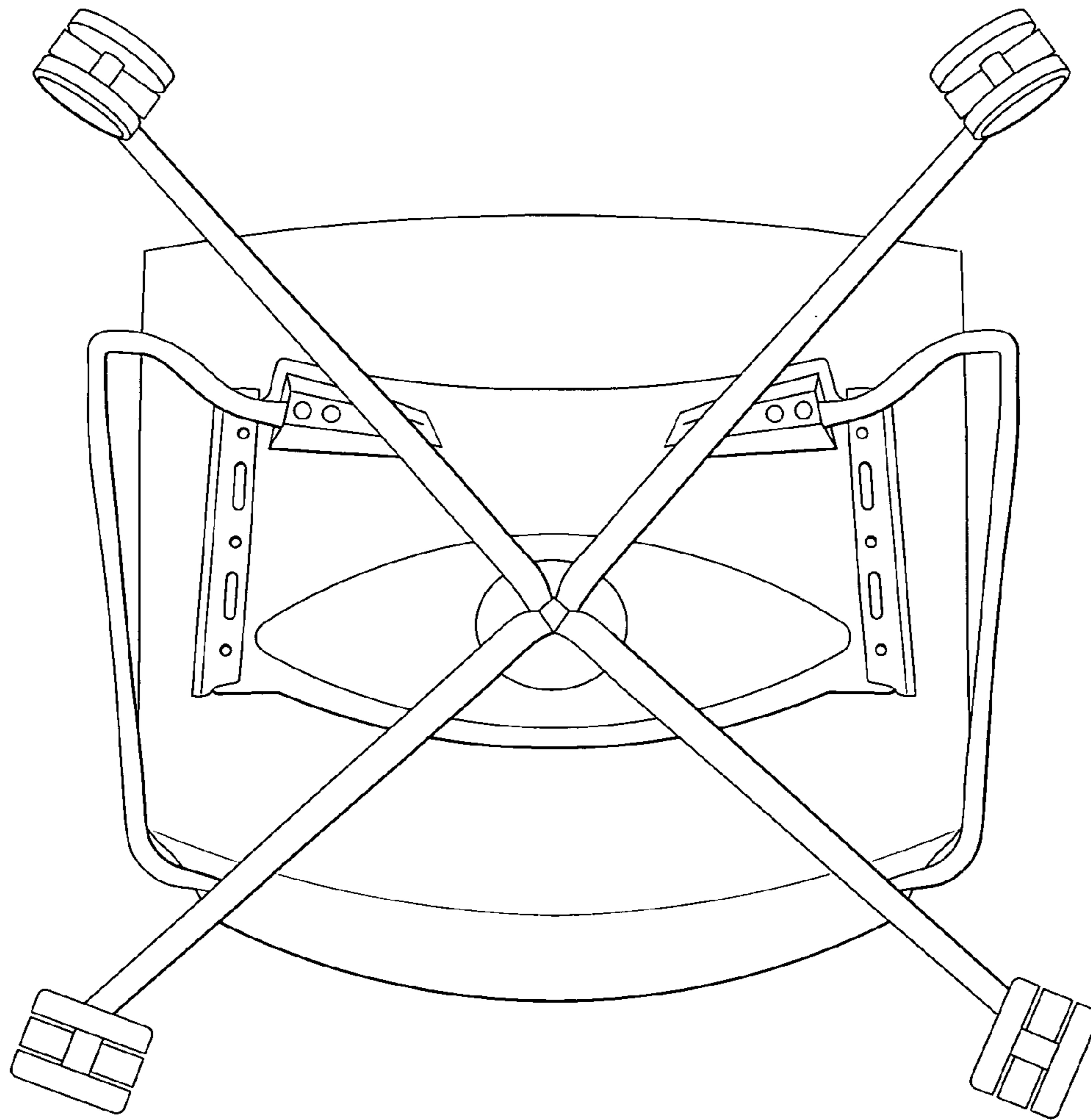

Fig. 7

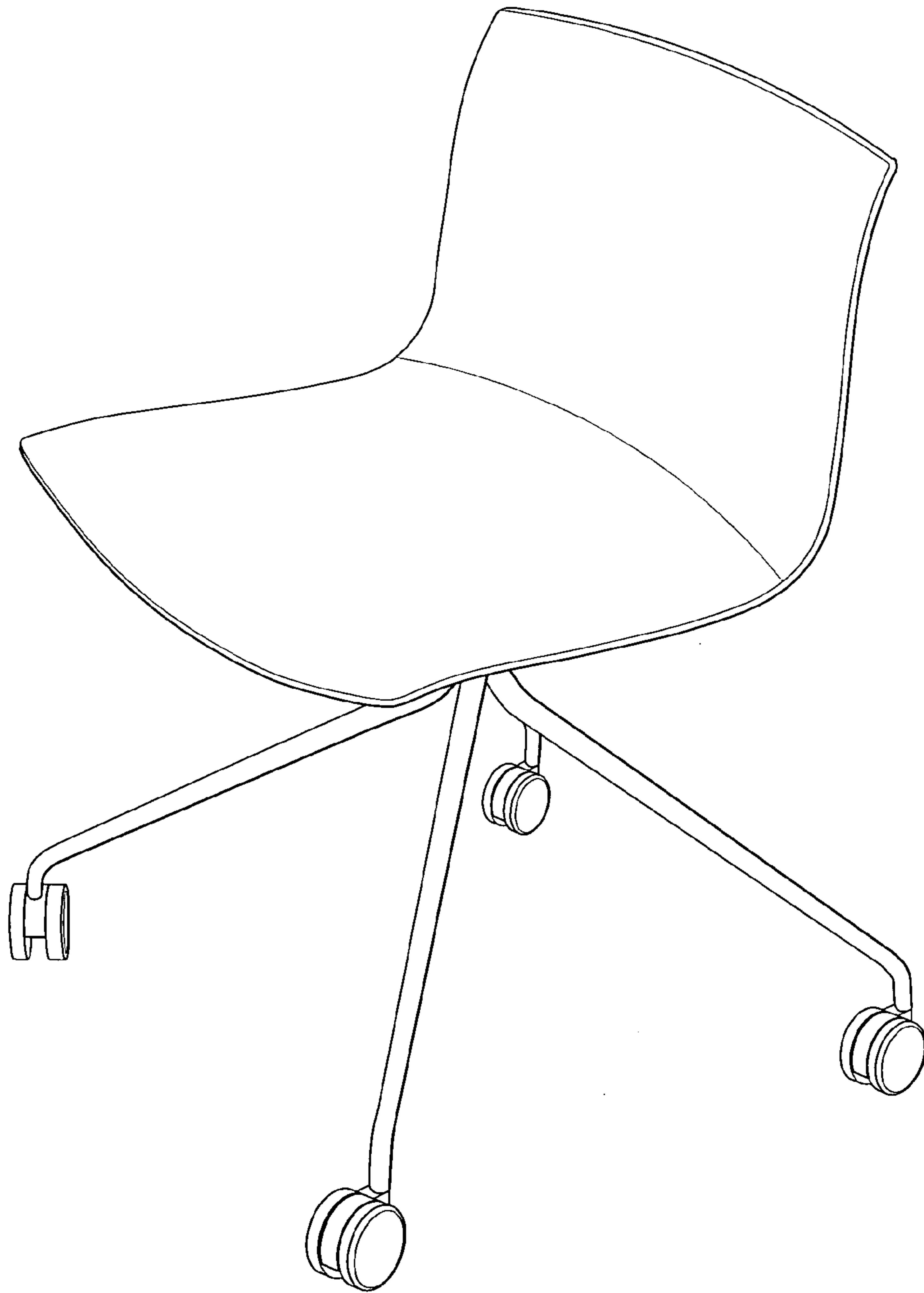

Fig. 8

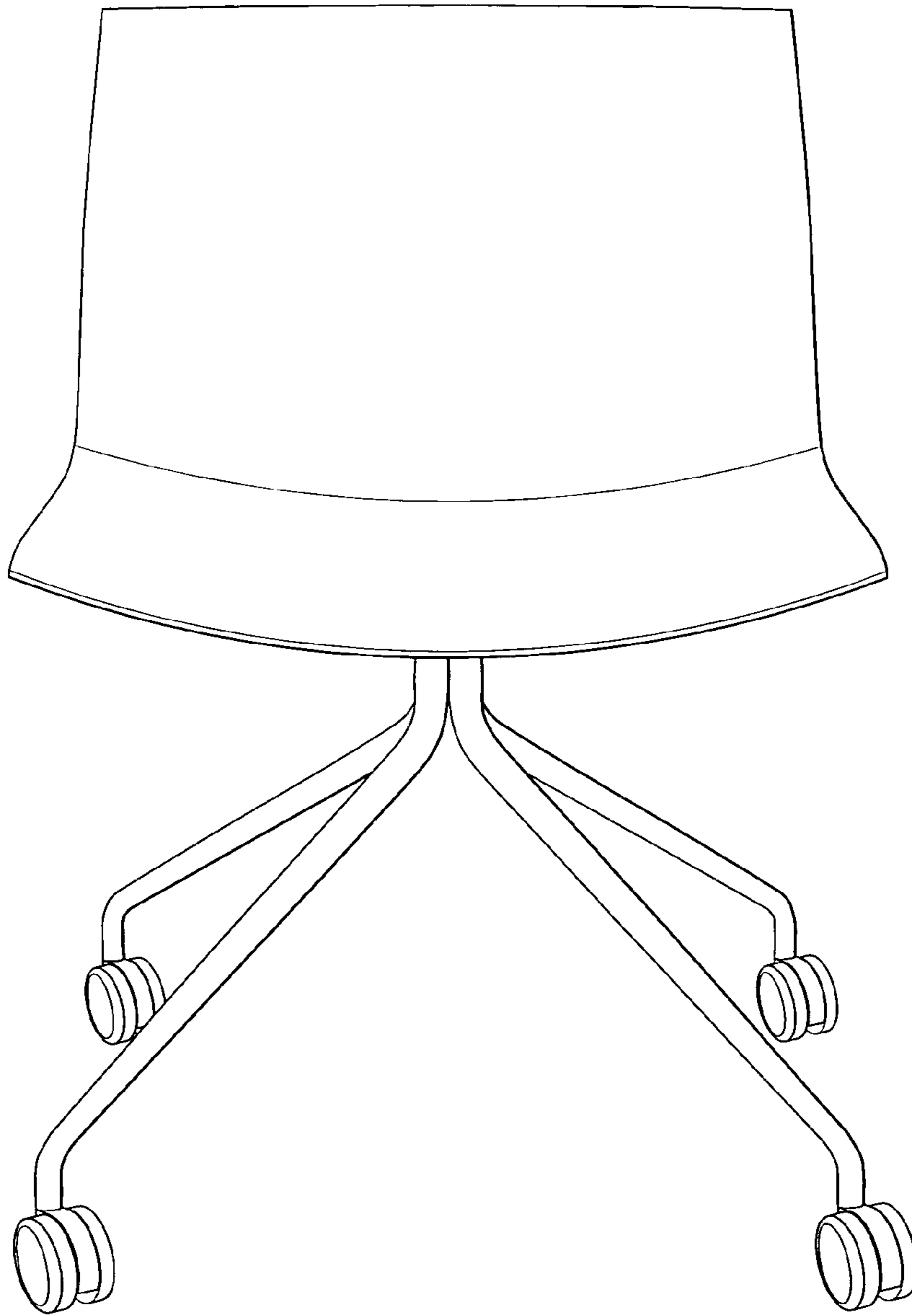

Fig. 9

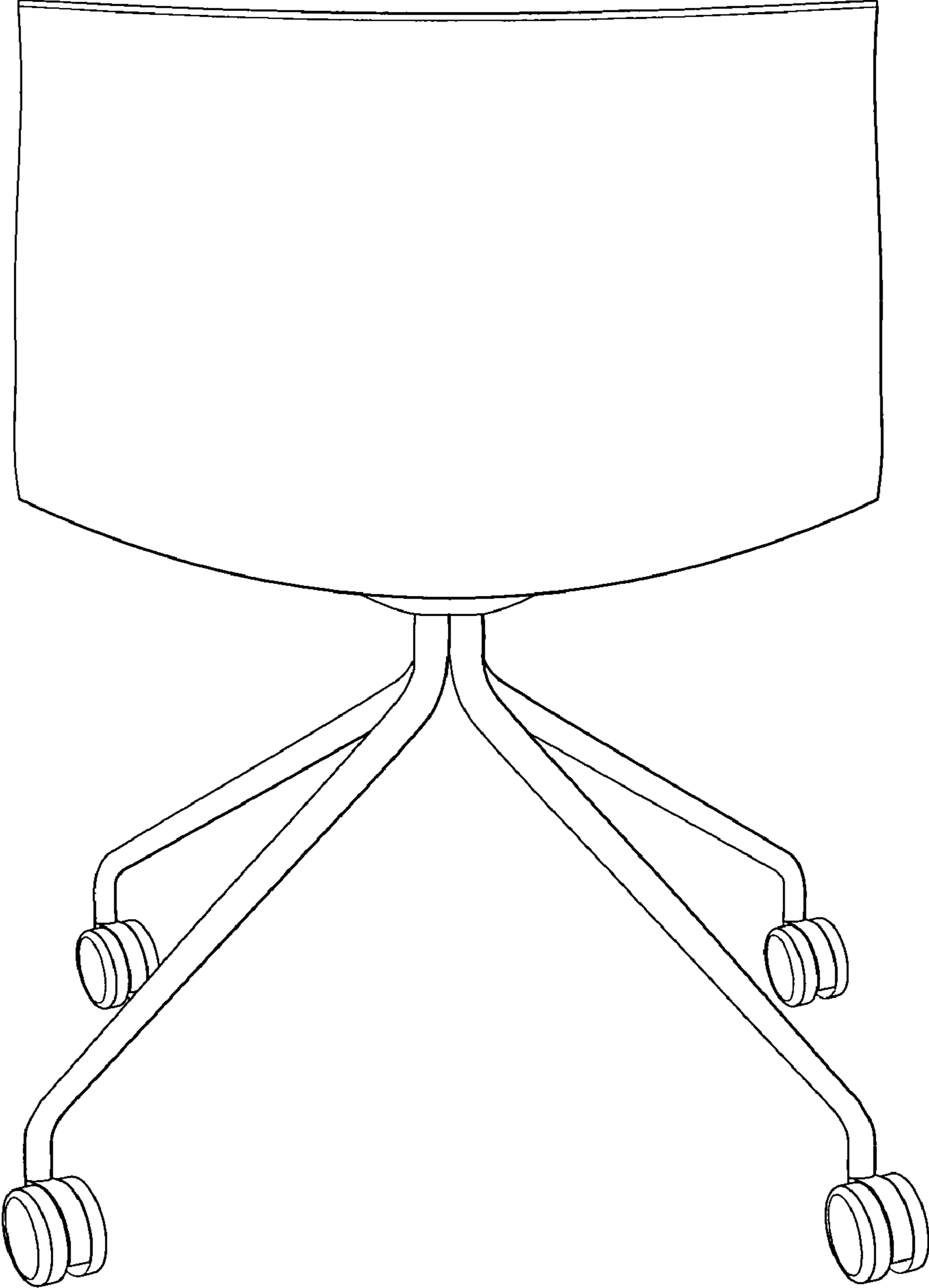

Fig. 10

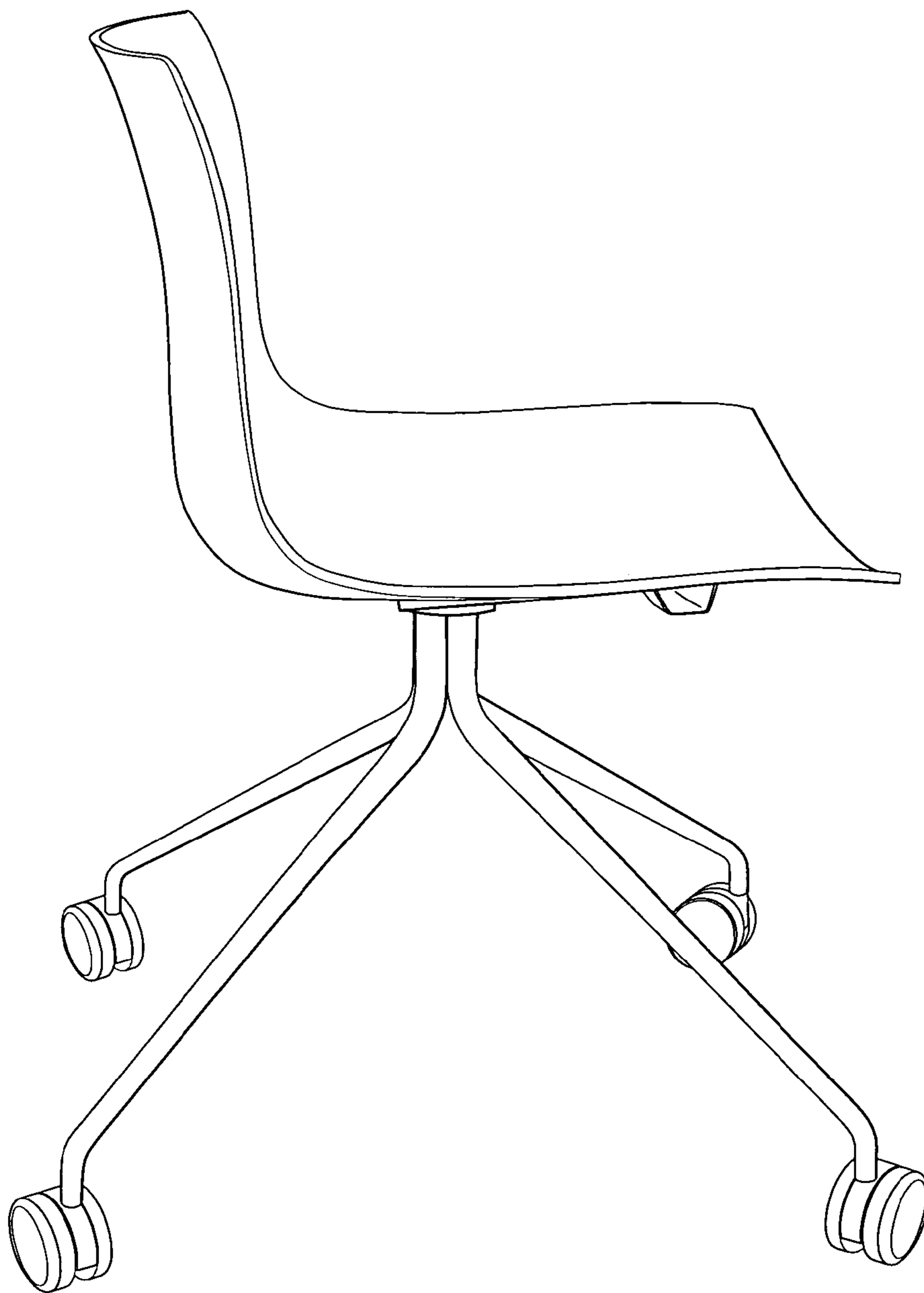

Fig. 11

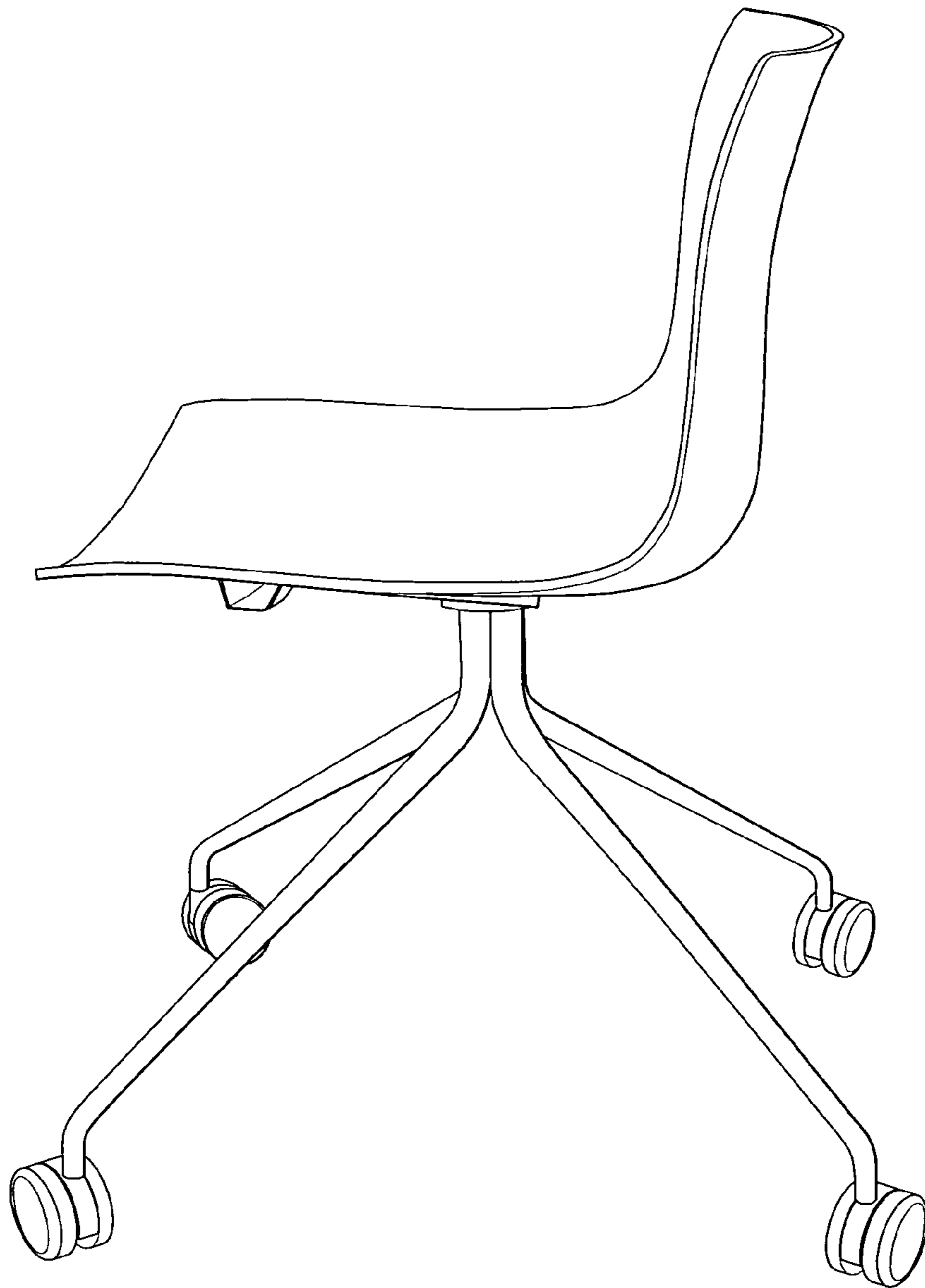

Fig. 12

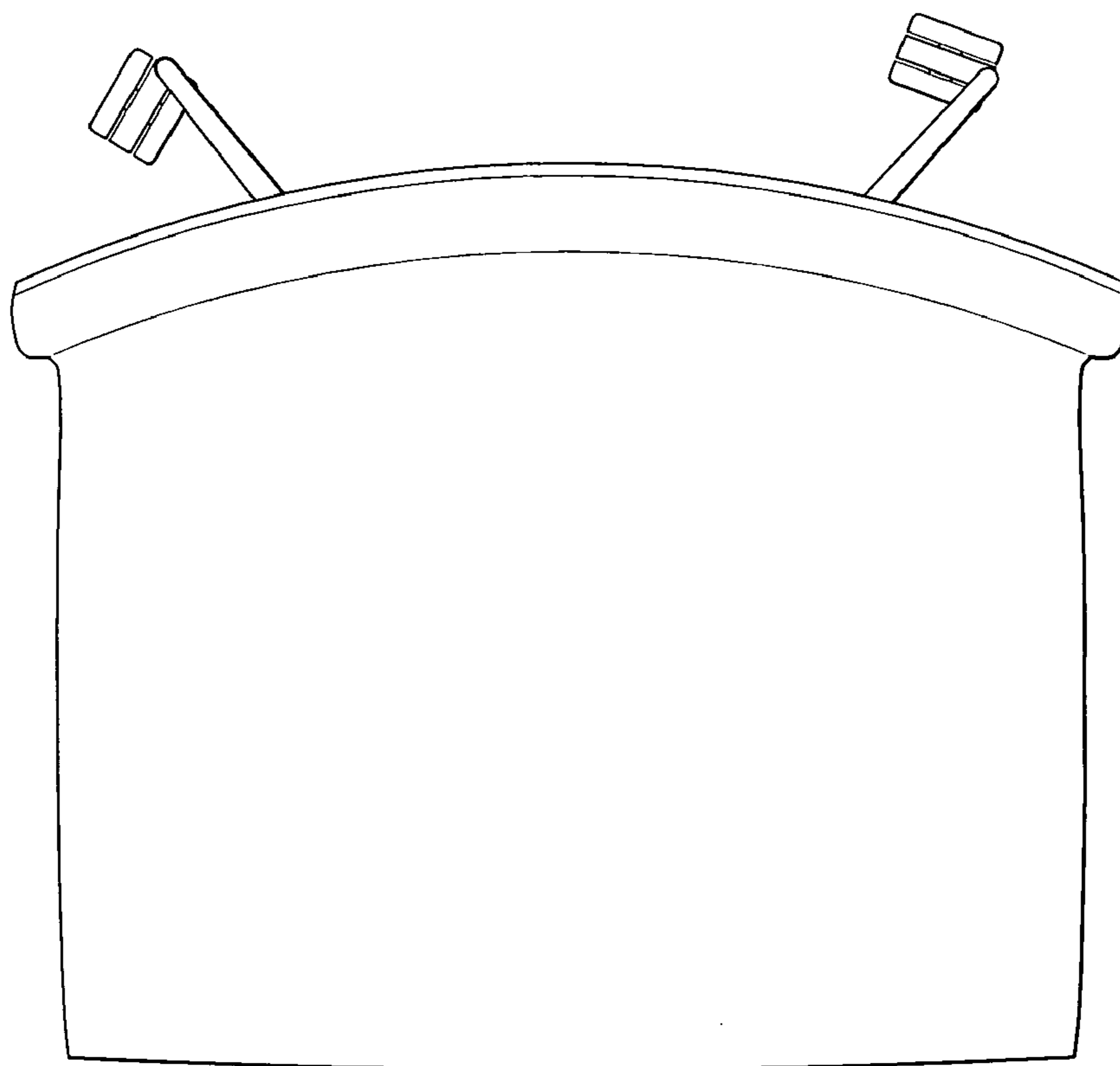

Fig. 13

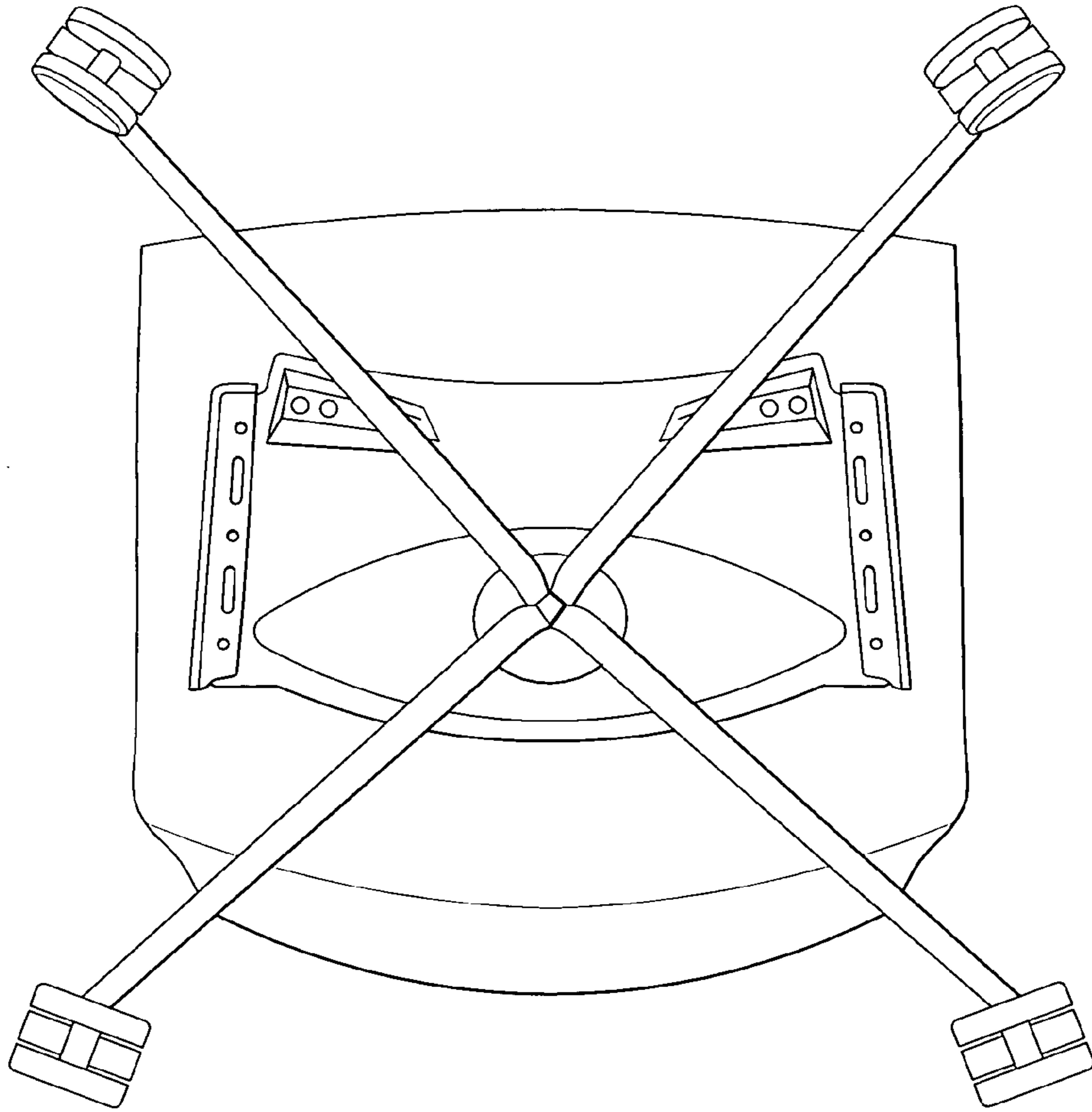

Fig. 14