



US00D565302S

(12) **United States Design Patent**
Fenton et al.

(10) **Patent No.:** **US D565,302 S**
(45) **Date of Patent:** **** Apr. 1, 2008**

(54) **BACKPACK WITH EXPANDABLE AREA**

(74) *Attorney, Agent, or Firm*—Baker Botts L.L.P.

(75) Inventors: **Timm John Fenton**, Lebanon, NJ
(US); **Paul Victor Scicluna**, Penndel,
PA (US)

(57) **CLAIM**

The ornamental design of a backpack with expandable area,
as shown and described.

(73) Assignee: **Tumi, Inc.**, South Plainfield, NJ (US)

(**) Term: **14 Years**

DESCRIPTION

(21) Appl. No.: **29/234,508**

FIG. 1 is an isometric view of a backpack with expandable
area showing our new design with a drawstring in a first
position;

(22) Filed: **Jul. 19, 2005**

FIG. 2 is a front view of the backpack with expandable area
of FIG. 1;

(51) **LOC (8) Cl.** **03-01**

(52) **U.S. Cl.** **D3/321**

(58) **Field of Classification Search** D3/270,
D3/201, 216, 217, 221, 233, 254, 267, 321;
D7/607; 224/153, 457, 578, 636, 651; 150/104,
150/107, 108

FIG. 3 is a top view of the backpack with expandable area
of FIG. 1;

See application file for complete search history.

FIG. 4 is a bottom view of the backpack with expandable
area of FIG. 1;

(56) **References Cited**

U.S. PATENT DOCUMENTS

D426,951 S *	6/2000	Rohrbach et al.	D3/217
D457,723 S *	5/2002	Tyler	D3/267
D477,461 S *	7/2003	Hillman	D3/267
D477,710 S *	7/2003	Hillman	D3/219
D482,864 S *	12/2003	Hillman	D3/267
D506,314 S *	6/2005	Roberts	D3/321

FIG. 5 is an isometric view of a backpack with expandable
area in the expanded position; and

FIG. 6 is a right side view of the backpack with expandable
area of FIG. 5; and,

FIG. 7 is a front view of the backpack with expandable area
of FIG. 1 with a drawstring in a second position.

* cited by examiner

The broken lines are provided for illustrative purposes only
and form no part of the claimed design. In addition, the
portions of the backpack that are not shown in the drawings
as well as any portion of the zipper, if any, do not form any
part of the claimed design.

Primary Examiner—Louis S. Zarfes
Assistant Examiner—Kathleen Sims

1 Claim, 6 Drawing Sheets

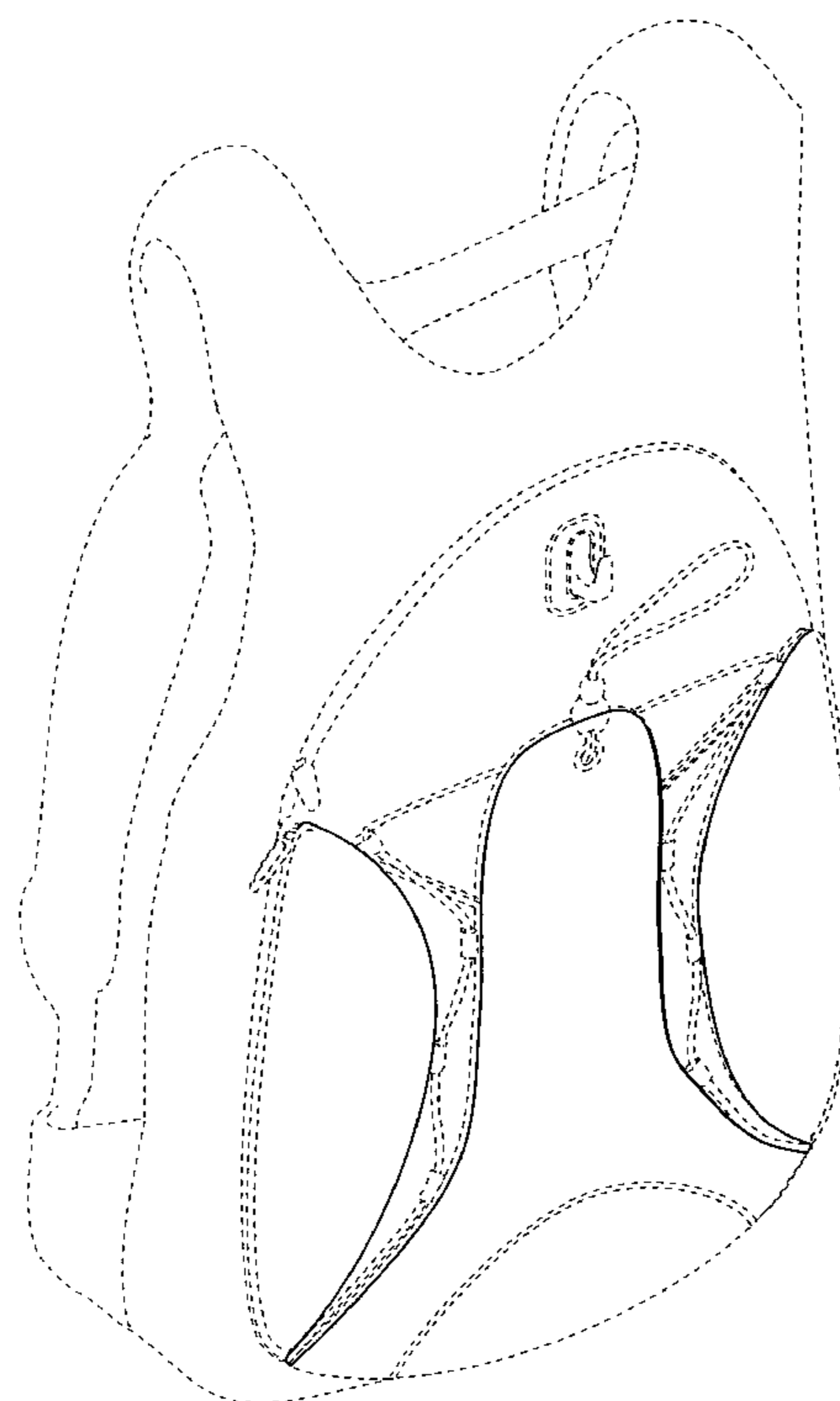

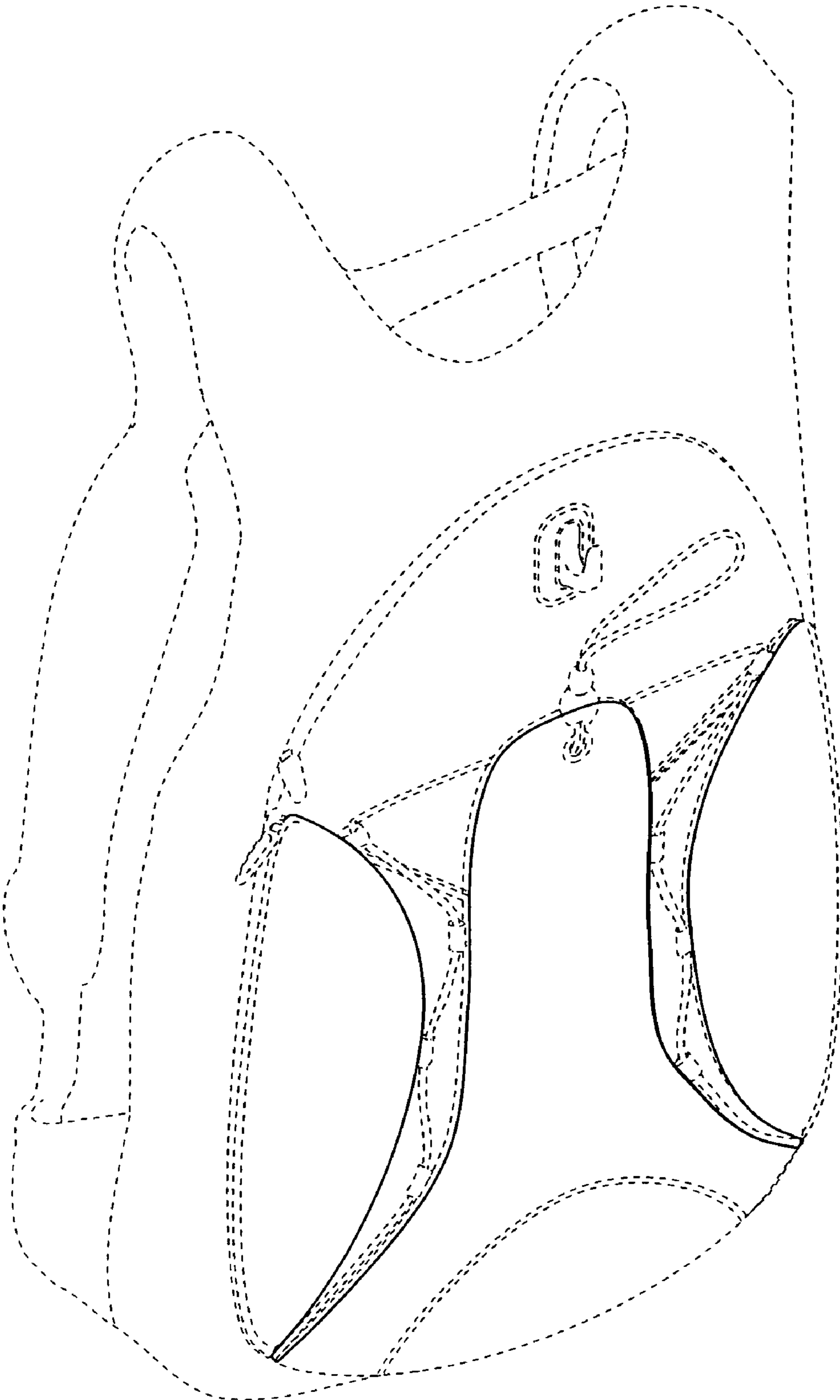

FIG. 1

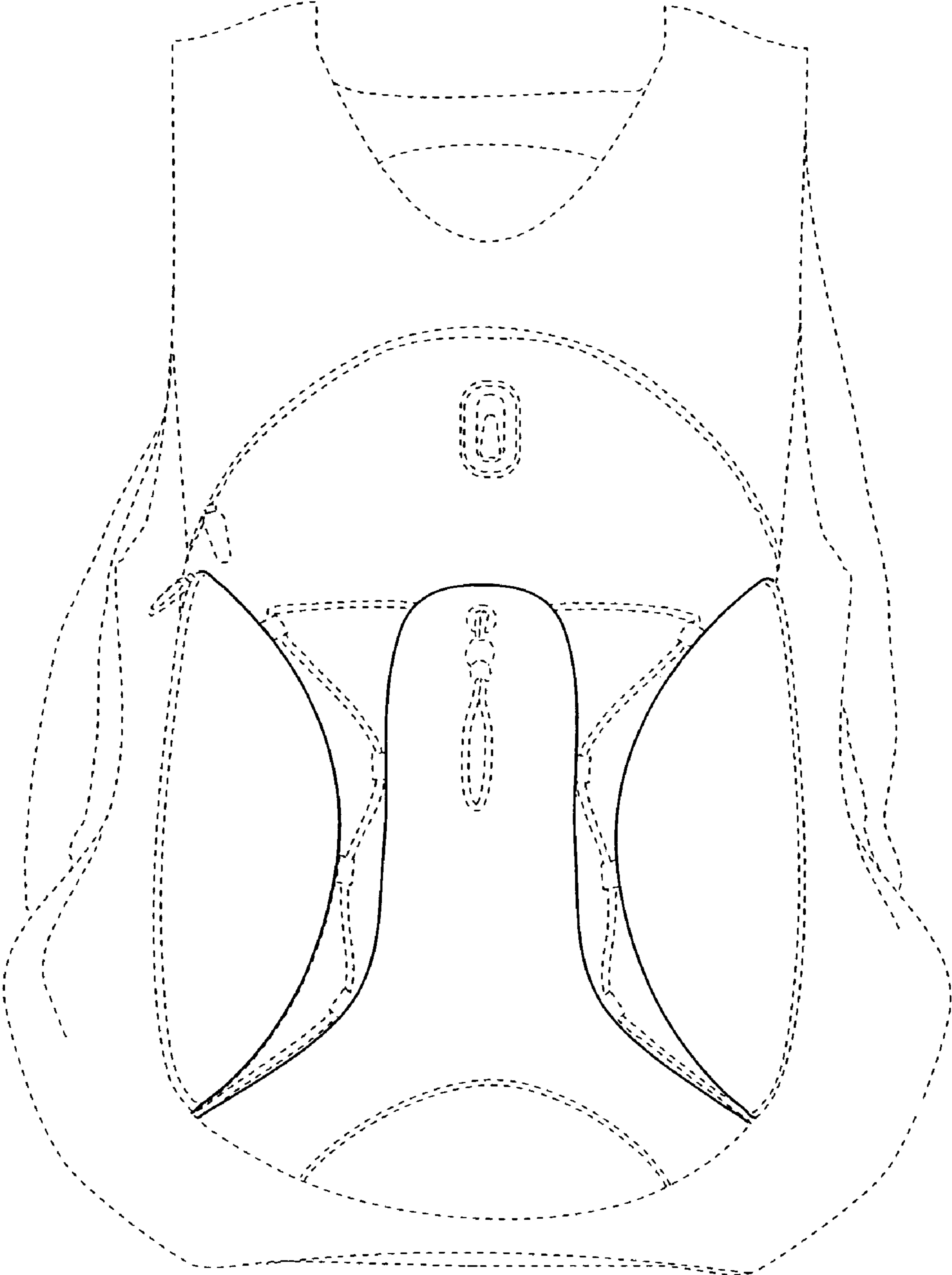

FIG. 2

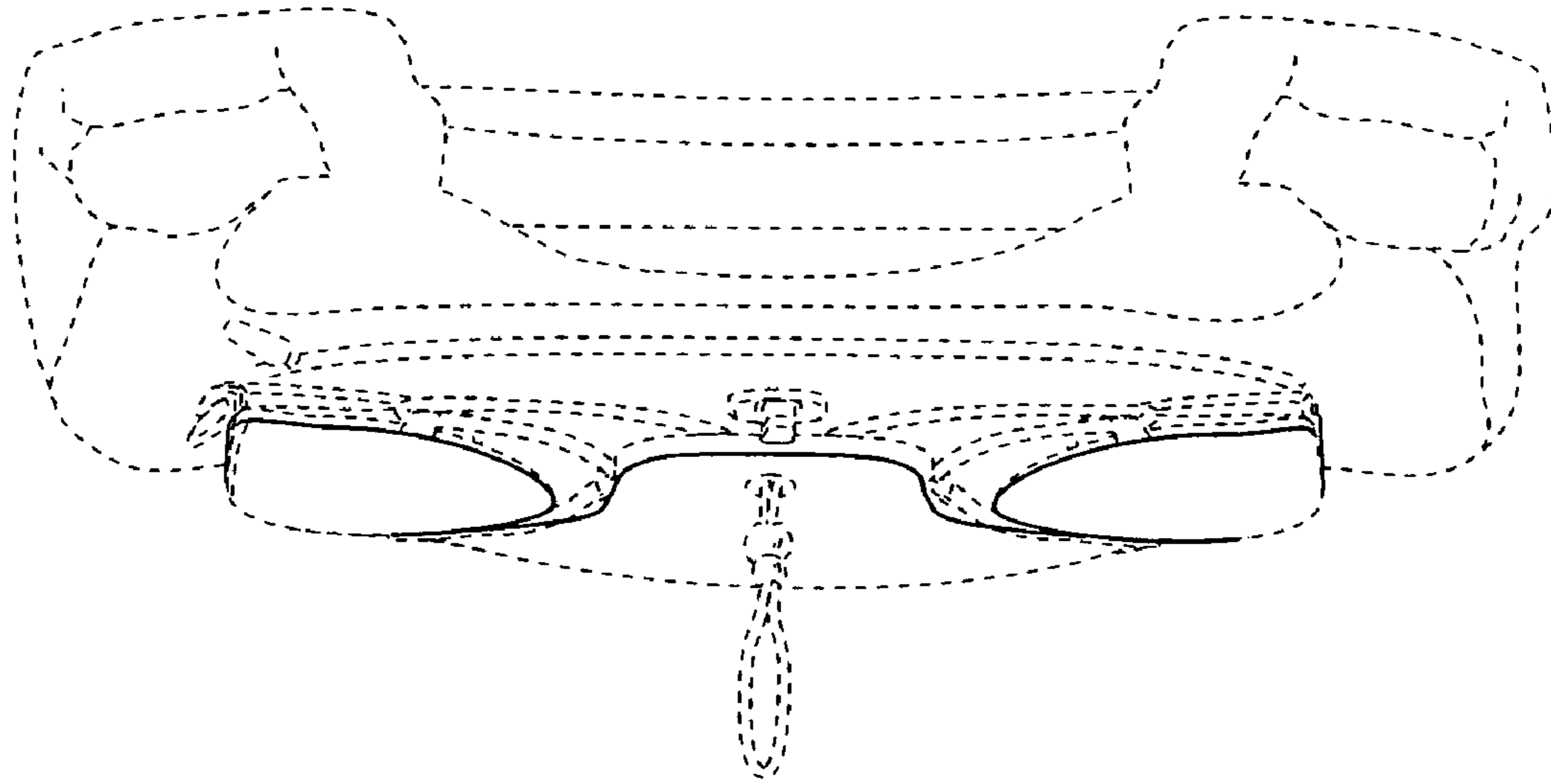

FIG. 3

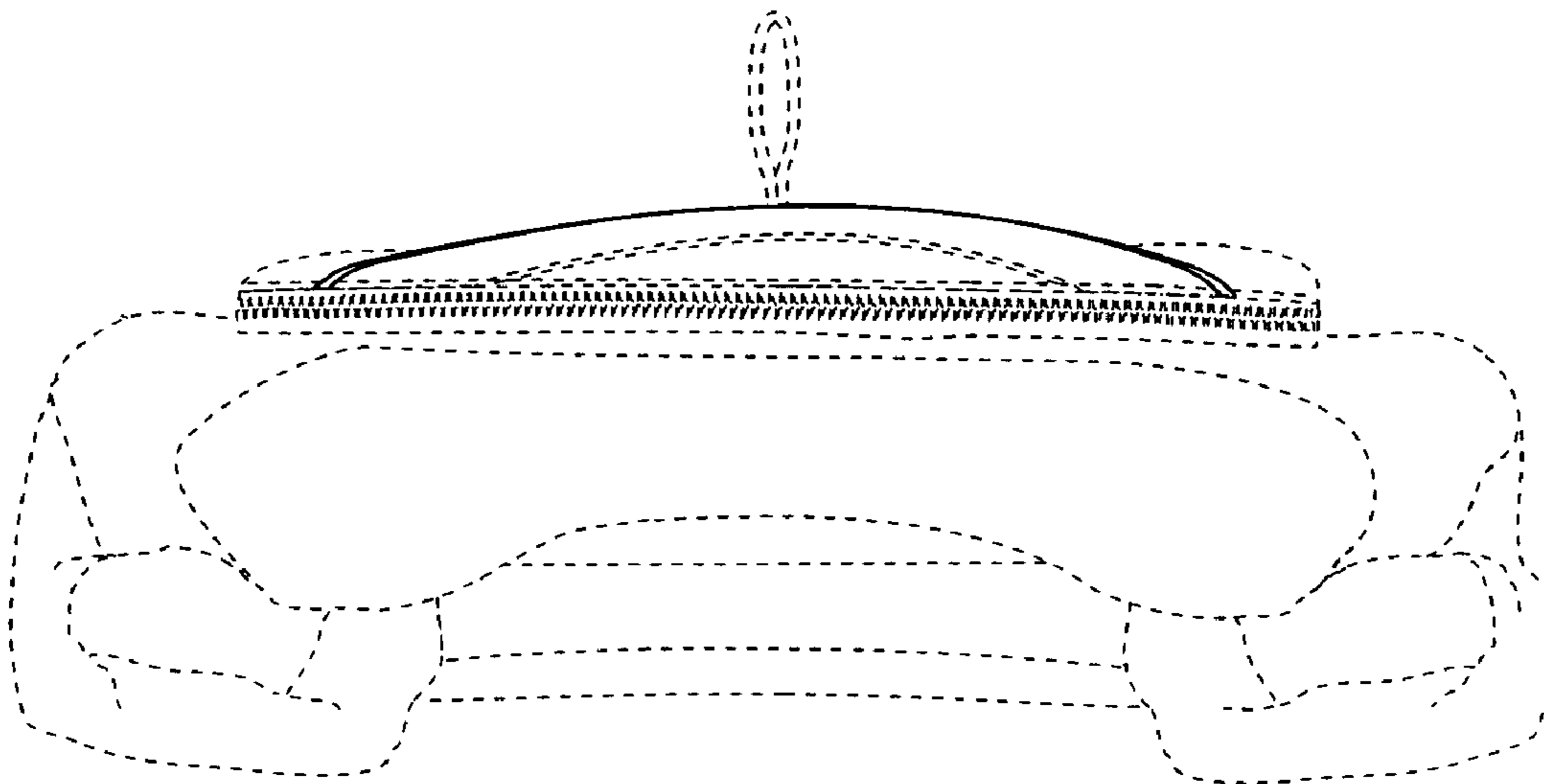

FIG. 4

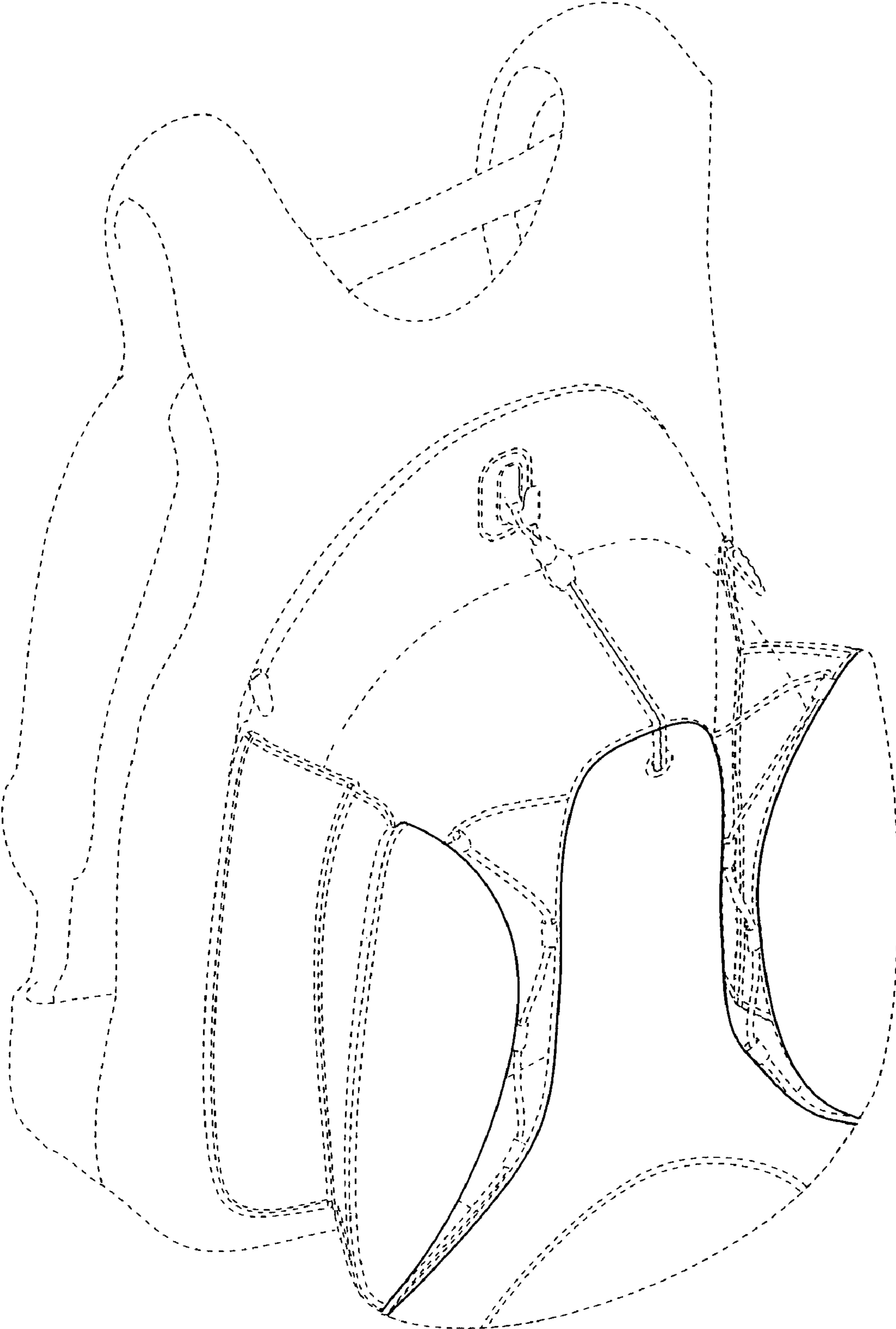

FIG. 5

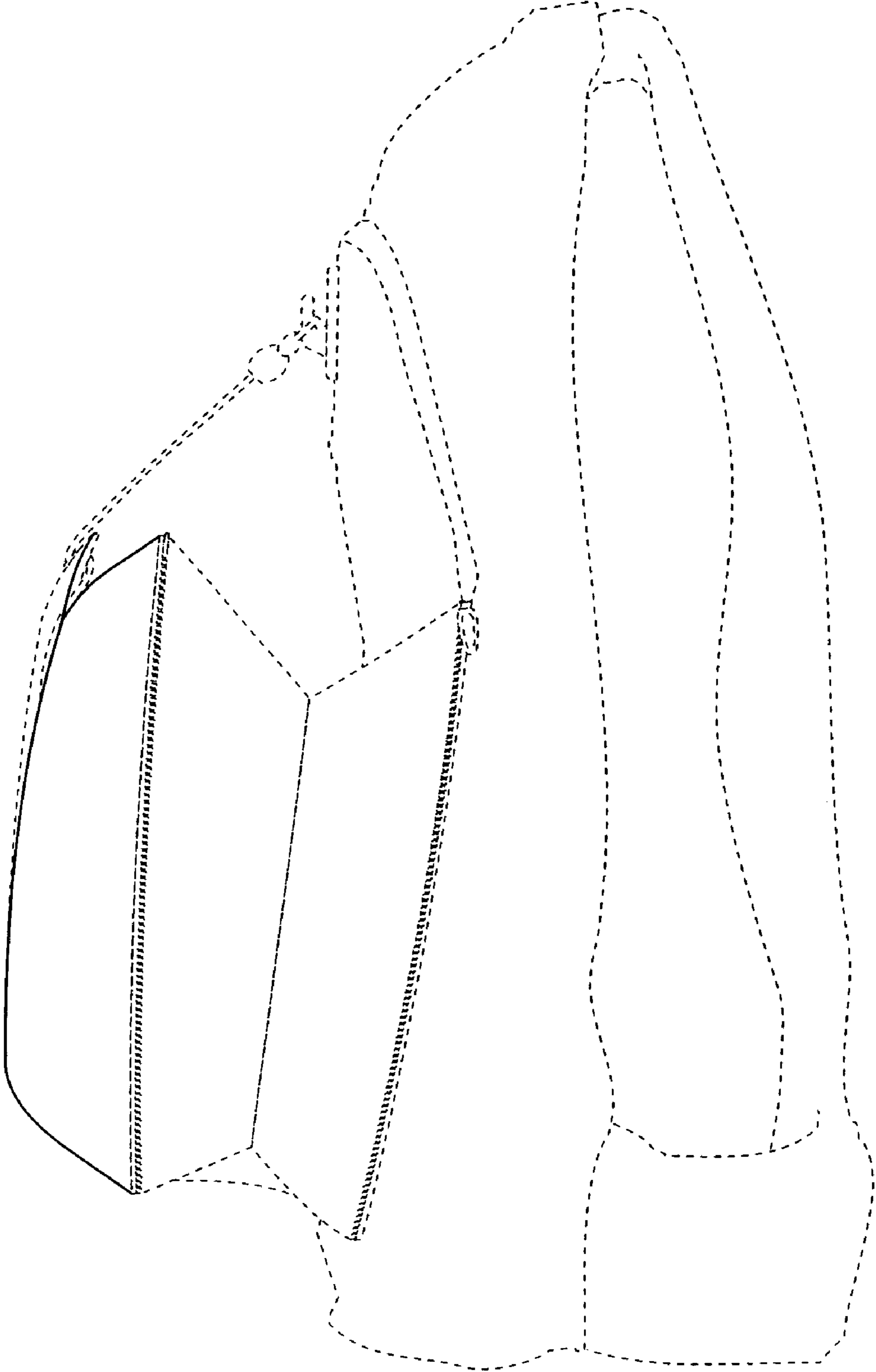

FIG. 6

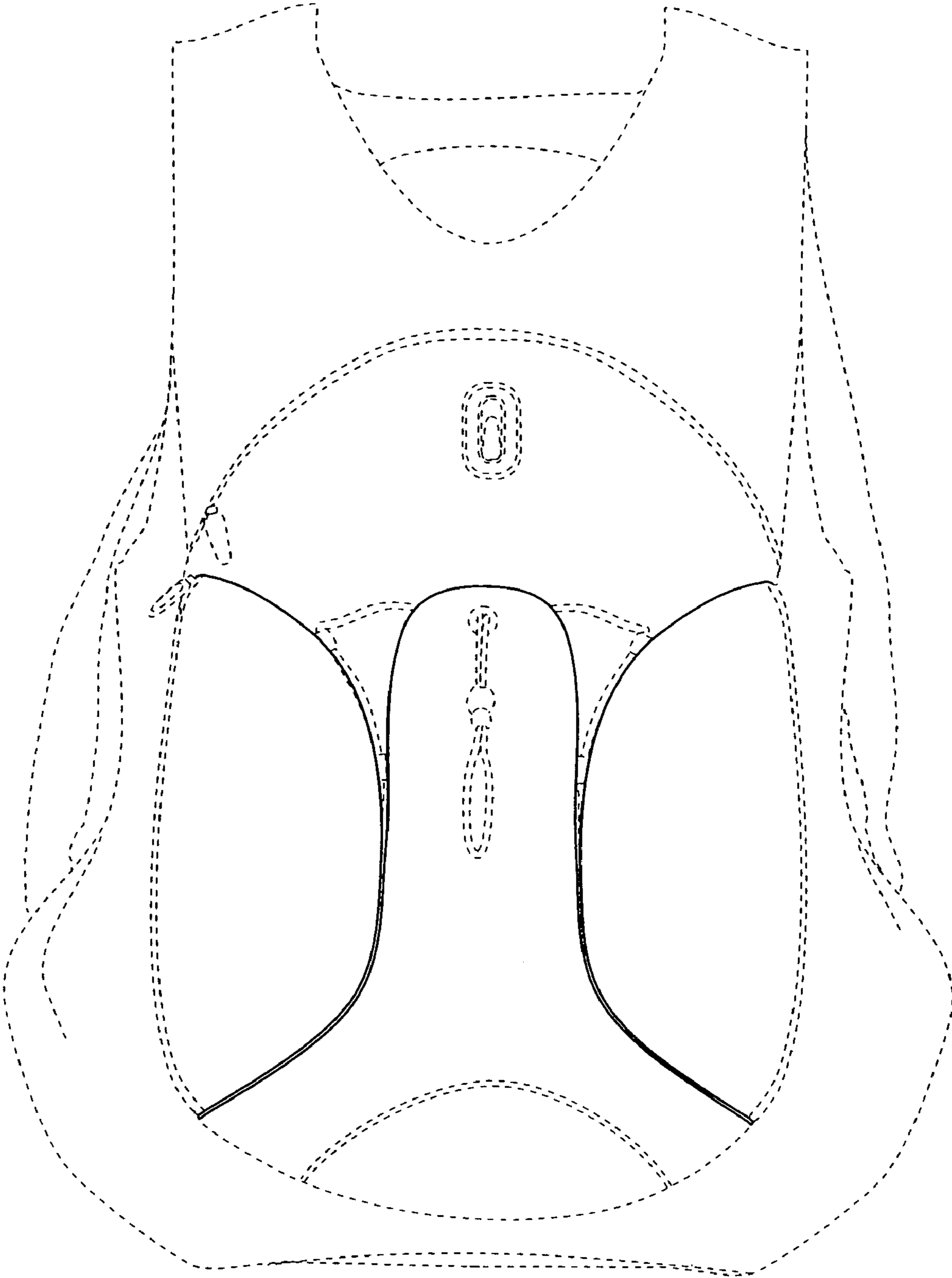

FIG. 7