



US00D565291S

(12) **United States Design Patent**
Brandenburg et al.

(10) **Patent No.:** **US D565,291 S**
(45) **Date of Patent:** **** Apr. 1, 2008**

(54) **MOBILE TELEPHONE CASE**

(75) Inventors: **Kyle Brandenburg**, Philadelphia, PA (US); **Edward Martin**, Hollywood, FL (US)

(73) Assignee: **Marware, Inc.**, Hollywood, FL (US)

(**) Term: **14 Years**

(21) Appl. No.: **29/282,807**

(22) Filed: **Jul. 30, 2007**

(51) **LOC (8) Cl.** **03-01**

(52) **U.S. Cl.** **D3/218**

(58) **Field of Classification Search** D3/218,
D3/201, 215, 219, 226; 224/230, 236, 240,
224/242, 904, 640, 646, 940; 379/419-420,
379/454-455, 446; D14/248, 253; 455/575.1-575;
206/305, 320

See application file for complete search history.

(56) **References Cited**

U.S. PATENT DOCUMENTS

D468,525 S *	1/2003	Boyle et al.	D3/218
D508,605 S *	8/2005	Hwang et al.	D3/218
D517,310 S *	3/2006	Aron et al.	D3/218
D529,713 S *	10/2006	Guyot et al.	D3/218
D551,856 S *	10/2007	Ko et al.	D3/218

* cited by examiner

Primary Examiner—Catherine R. Oliver

(74) *Attorney, Agent, or Firm*—Laurence A. Greenberg;
Werner H. Stemer; Ralph E. Locher

(57) **CLAIM**

The ornamental design for the mobile telephone case, as shown and described.

DESCRIPTION

FIG. 1 is a perspective, front-elevational view of an assembled mobile telephone case showing my new design;

FIG. 2 is a right side-elevational view thereof;

FIG. 3 is a top-plan view thereof;

FIG. 4 is a left side-elevational view thereof;

FIG. 5 is a bottom-plan view thereof;

FIG. 6 is a rear-elevational view thereof;

FIG. 7 is another rear-elevational view of the assembled mobile telephone case showing my new design, with ear buds and a cord wrapped in place;

FIG. 8 is a rear-perspective view of the assembled mobile telephone case of FIG. 1;

FIG. 9 is a front-perspective view thereof;

FIG. 10 is a front-elevational view of a disassembled outer shell of the mobile telephone case showing my new design;

FIG. 11 is a right side-elevational thereof;

FIG. 12 is a top-plan view thereof;

FIG. 13 is a left side-elevational view thereof;

FIG. 14 is a bottom-plan view thereof;

FIG. 15 is a rear-elevational view of the disassembled outer shell of the mobile telephone case showing my new design;

FIG. 16 is a rear-elevational view of a disassembled insert of the mobile telephone case showing my new design;

FIG. 17 is a top-plan view thereof;

FIG. 18 is a side-elevational view thereof;

FIG. 19 is a front-elevational view thereof;

FIG. 20 is a bottom-plan view thereof; and,

FIG. 21 is an exploded, perspective view of the insert and shell of the mobile telephone case showing my new design, prior to assembly.

The broken line showing of environment in the drawings is included for the purpose of illustrating only and forms no part of the claimed design.

1 Claim, 5 Drawing Sheets

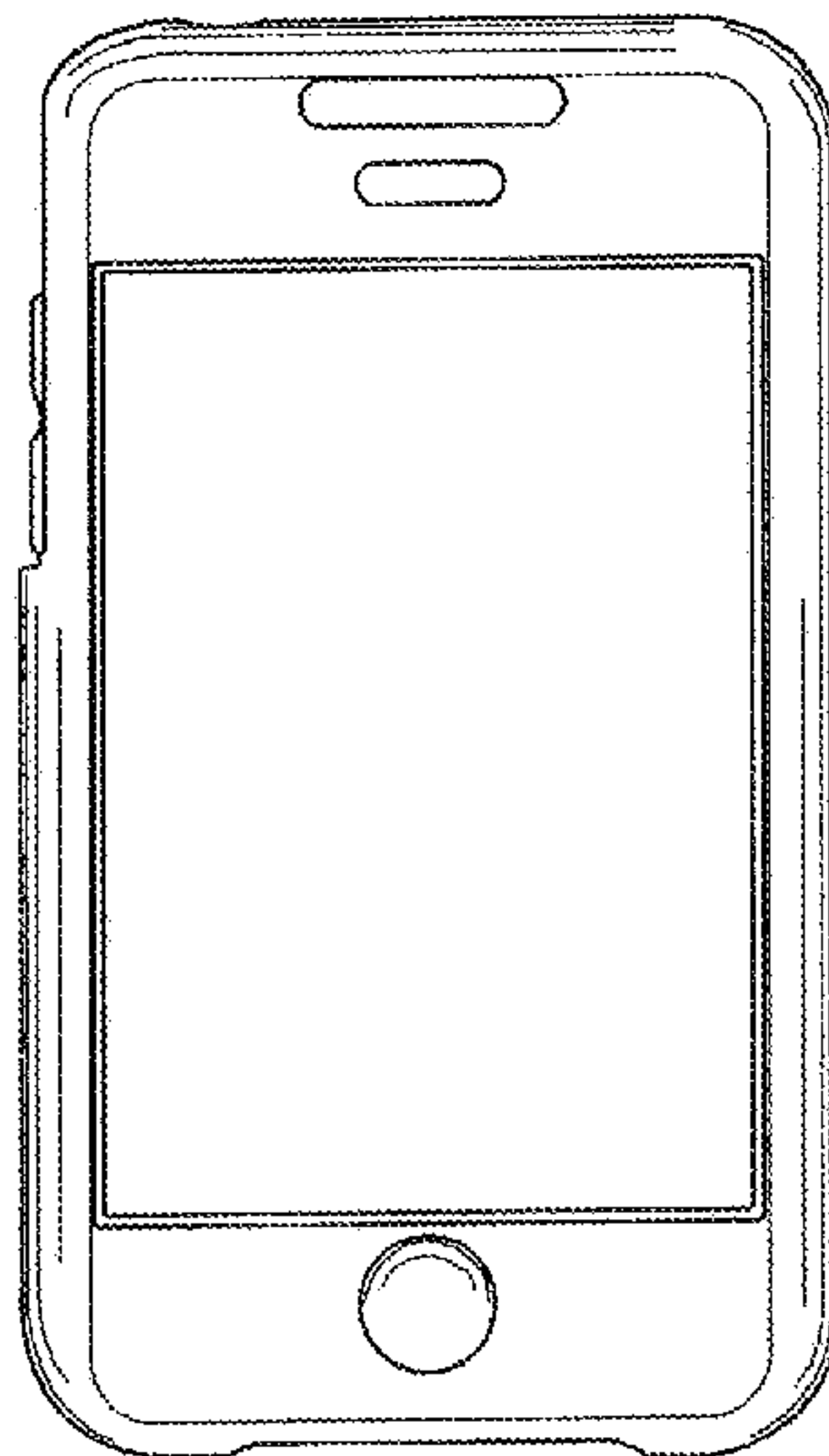

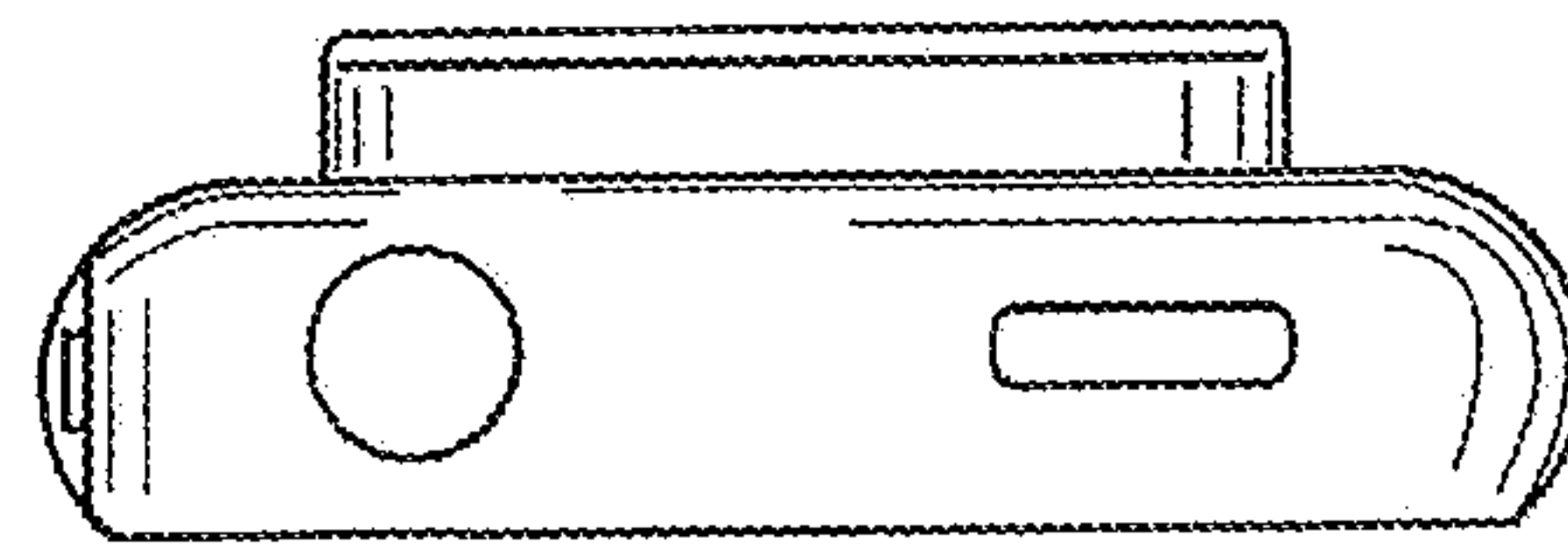

Fig 3

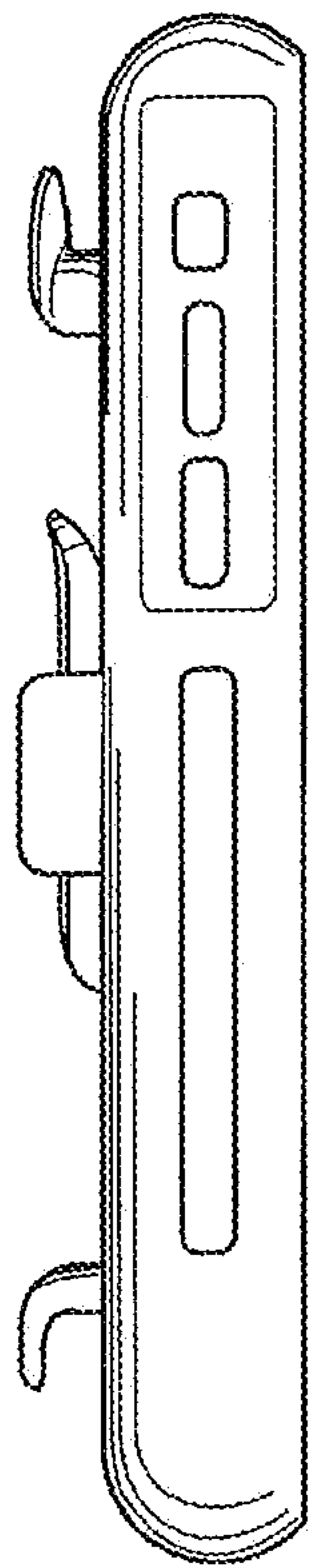

Fig 4

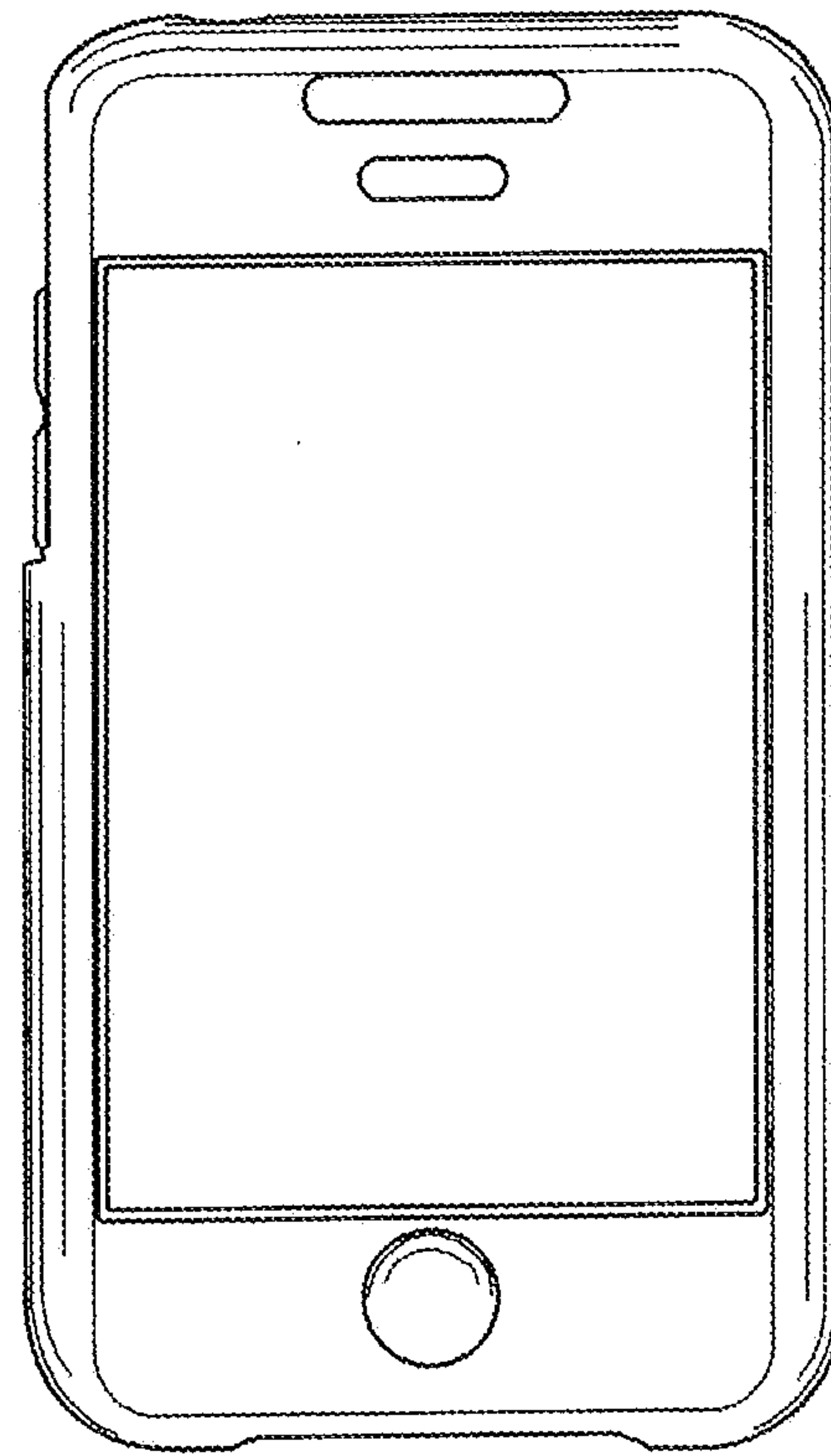

Fig 1

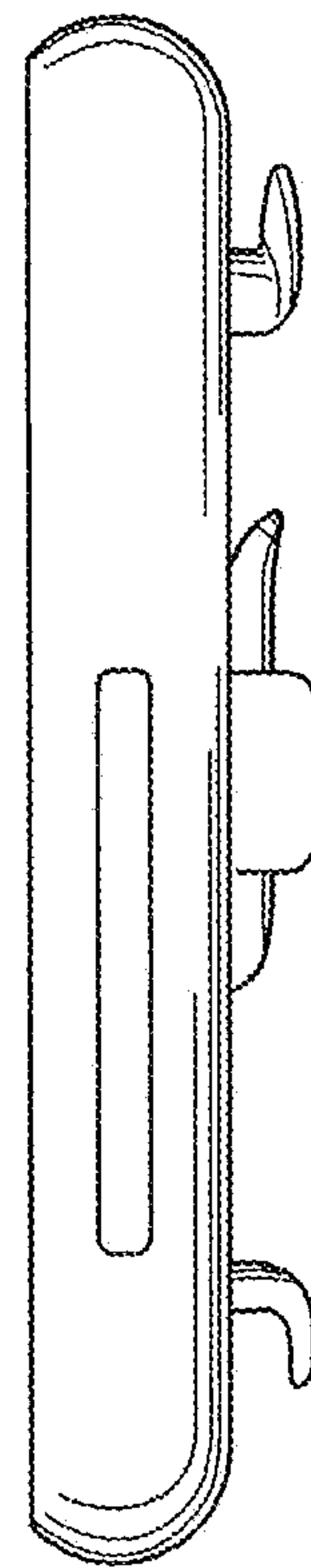

Fig 2

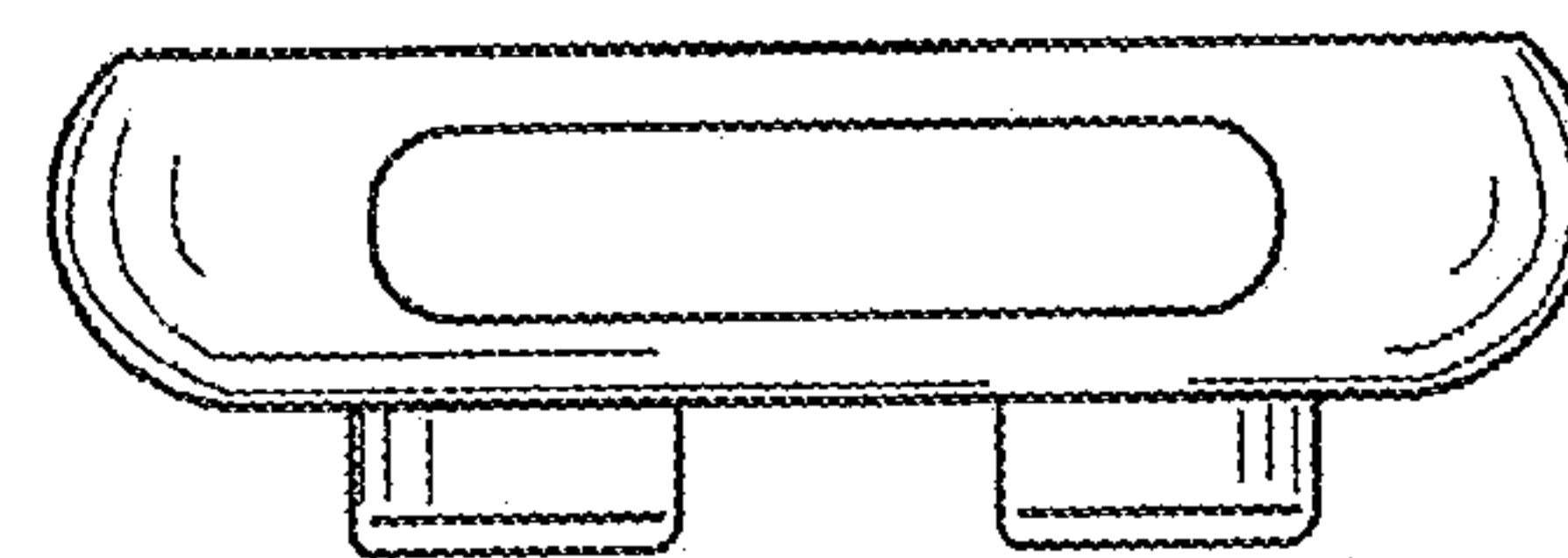

Fig 5

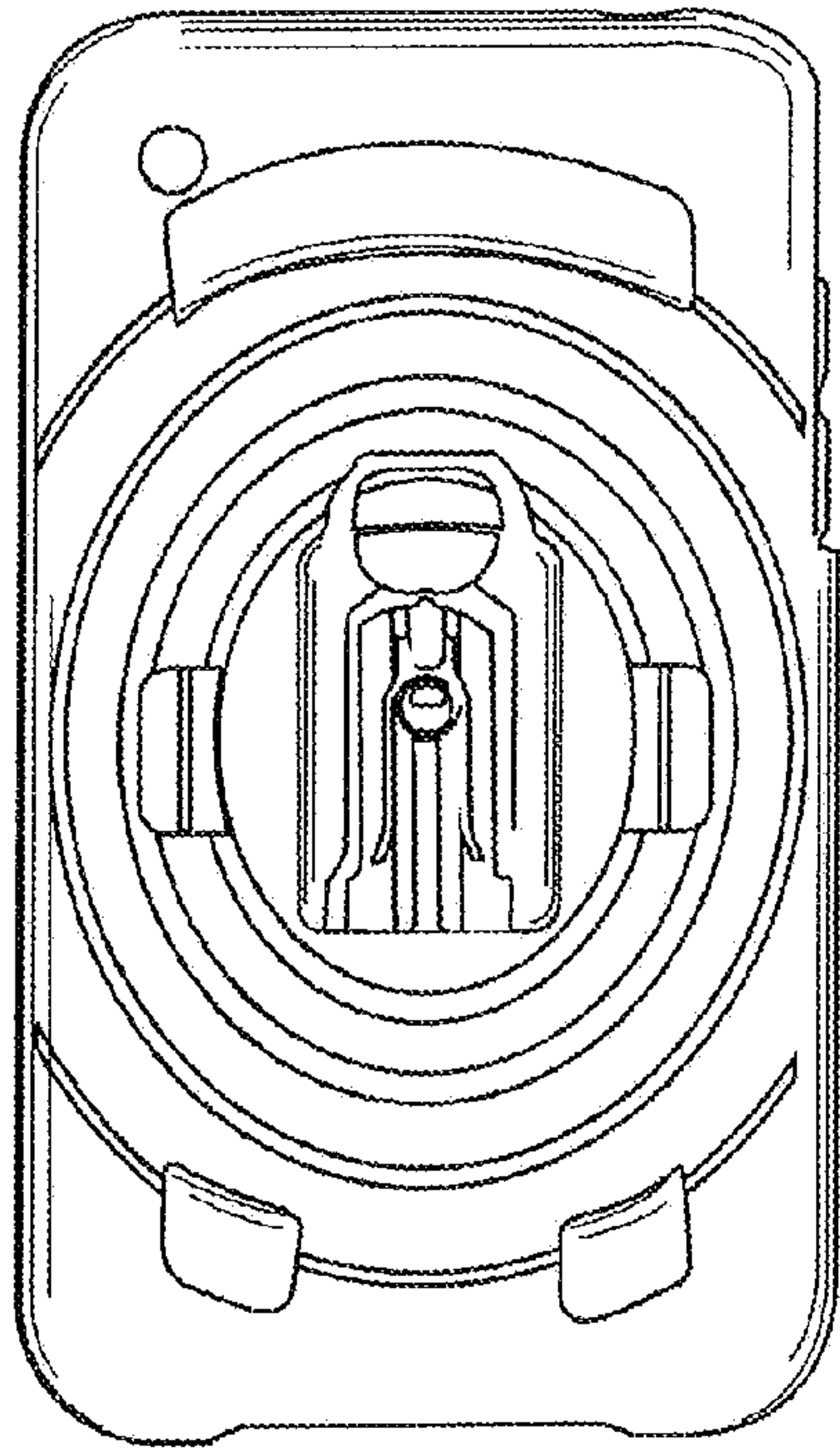

Fig 6

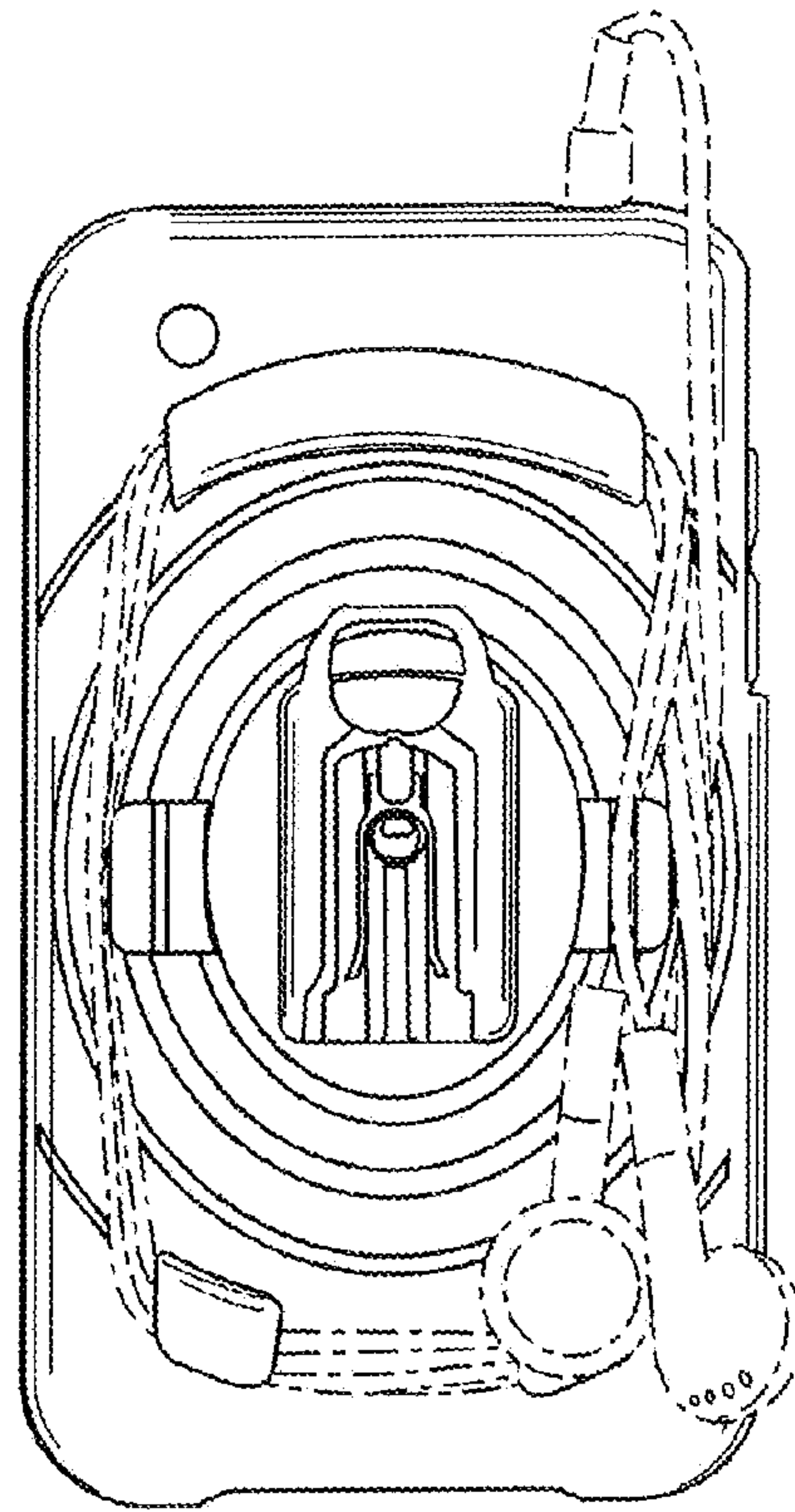

Fig 7

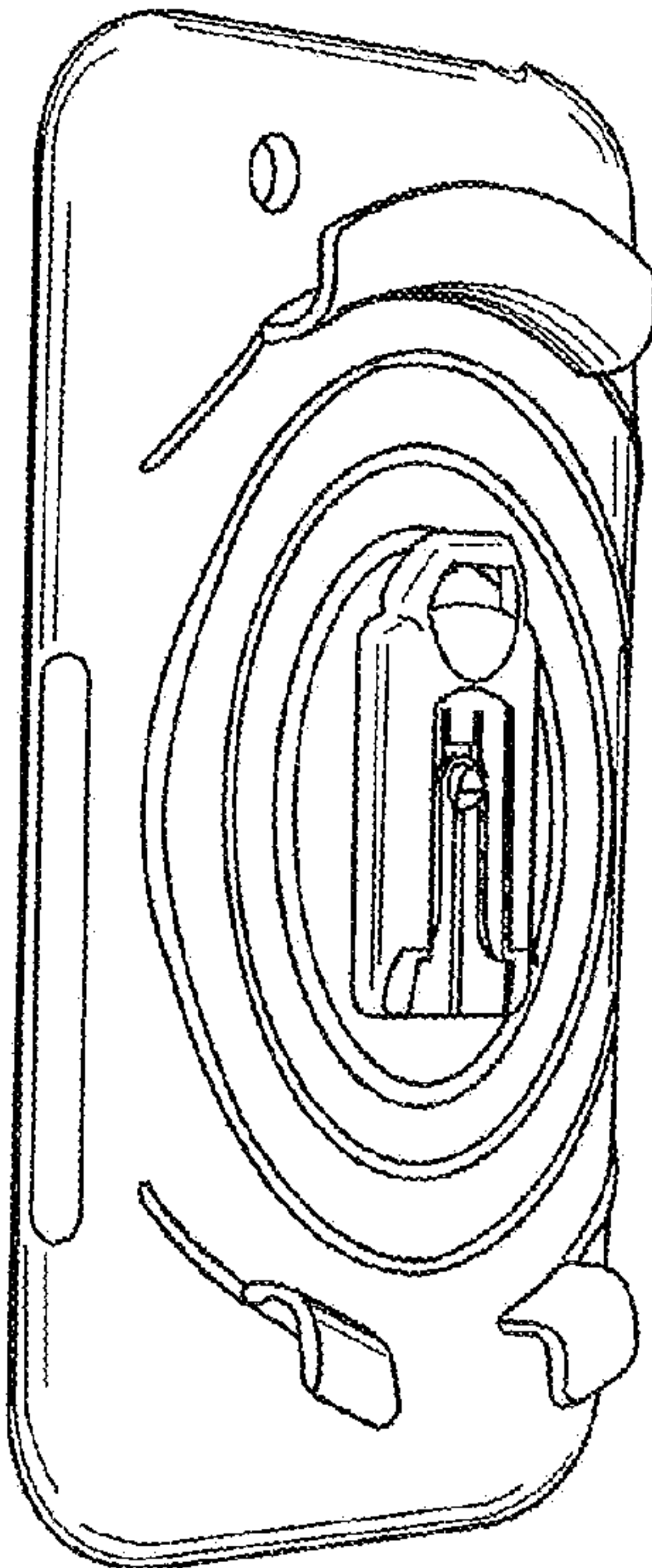

Fig 8

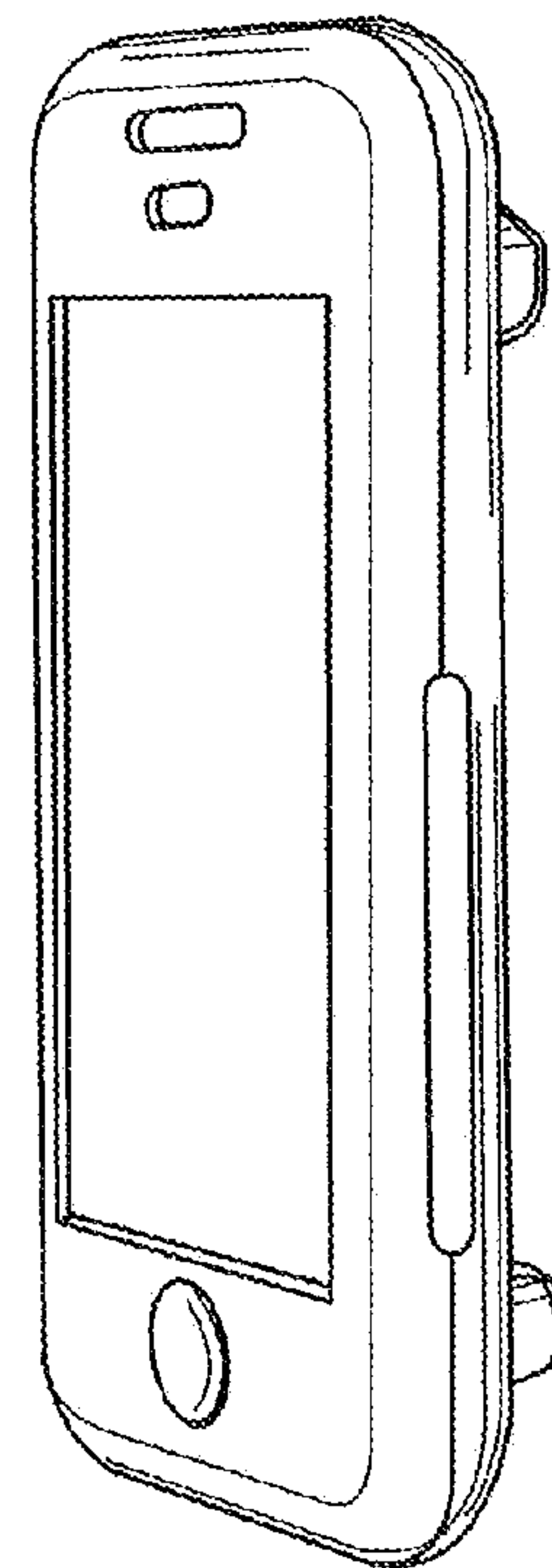

Fig 9

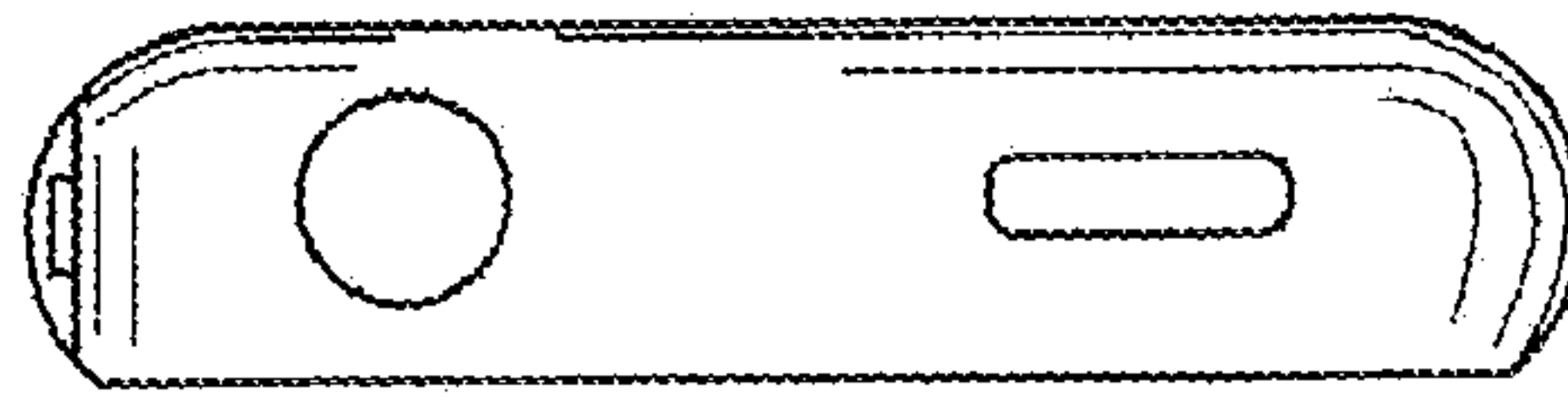

Fig 12

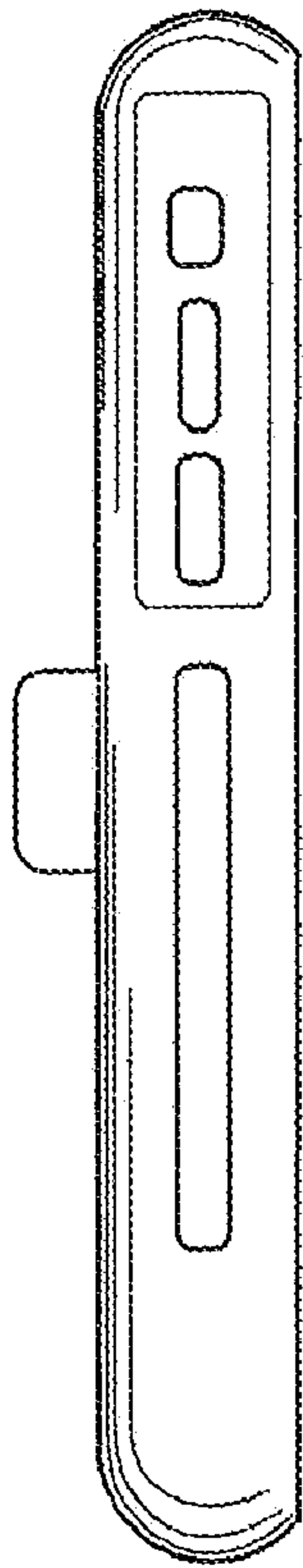

Fig 13

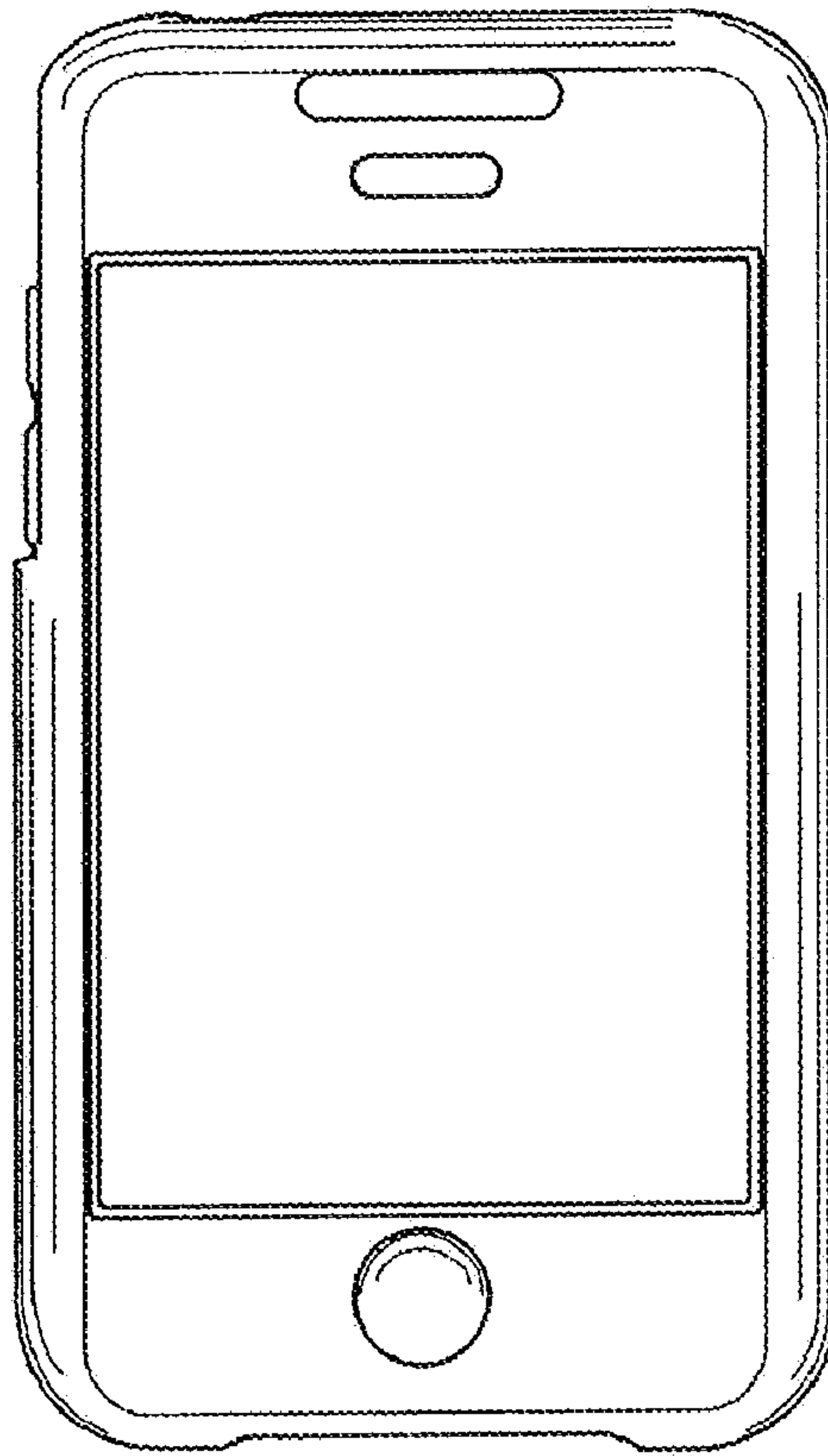

Fig 10

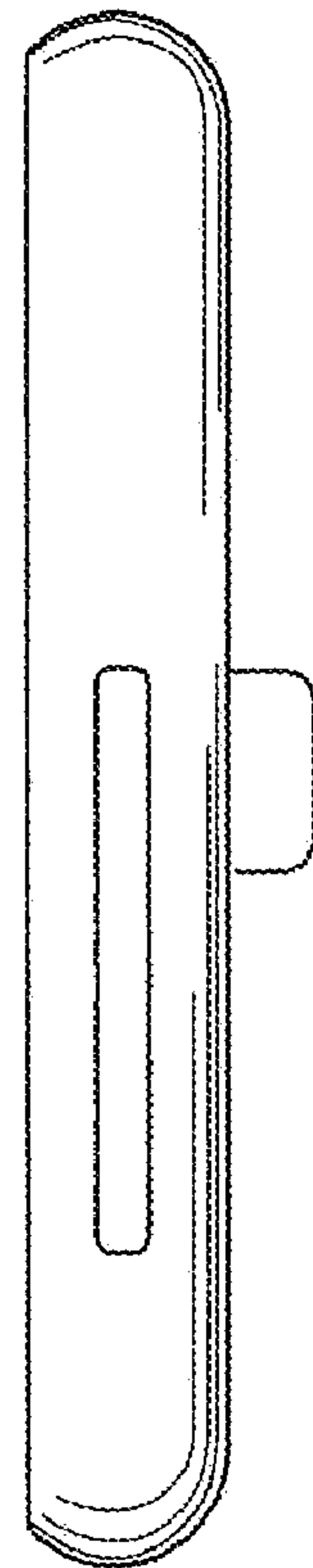

Fig 11

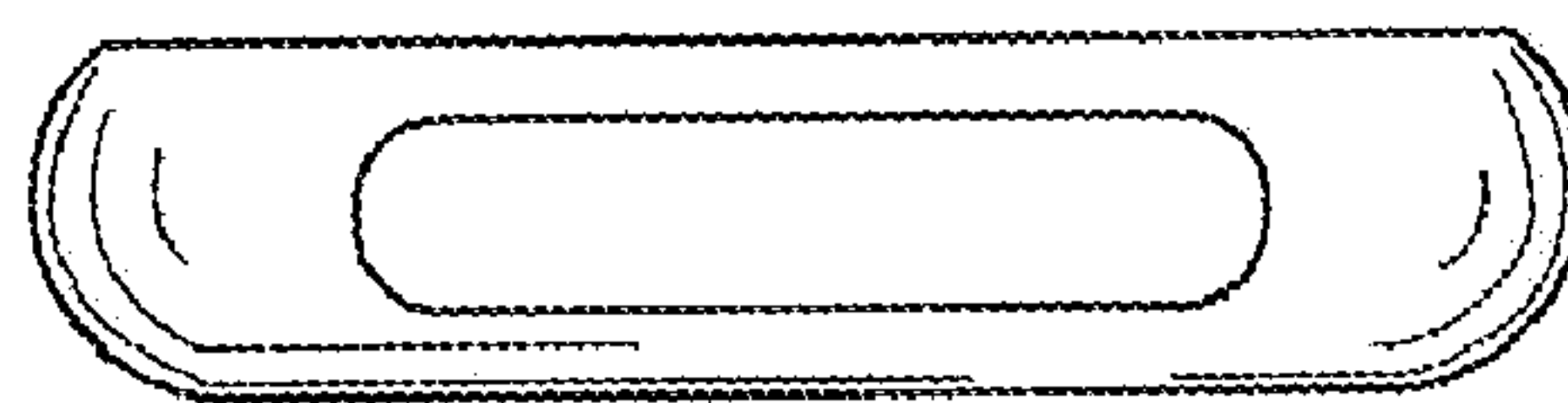

Fig 14

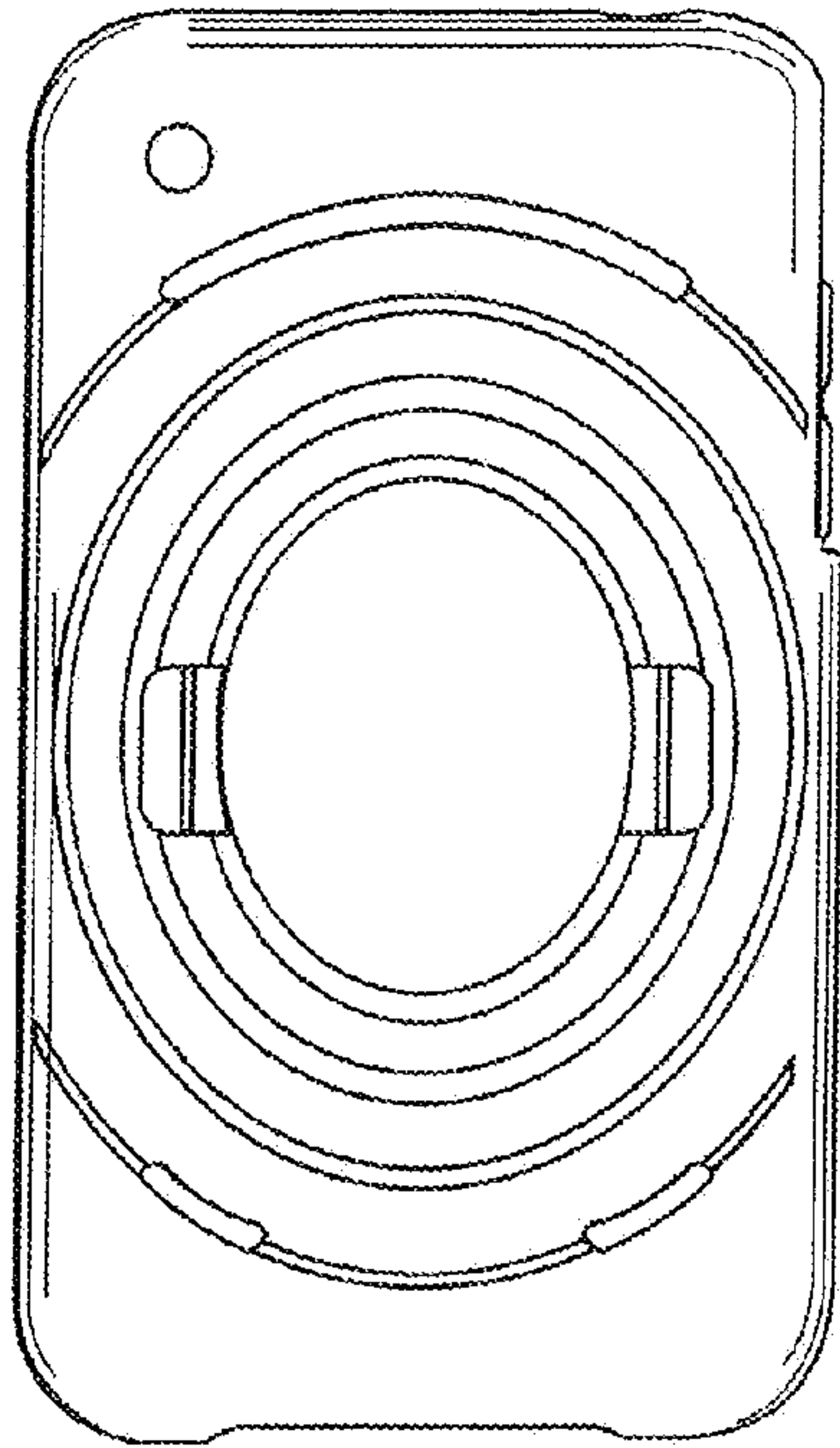

Fig 15

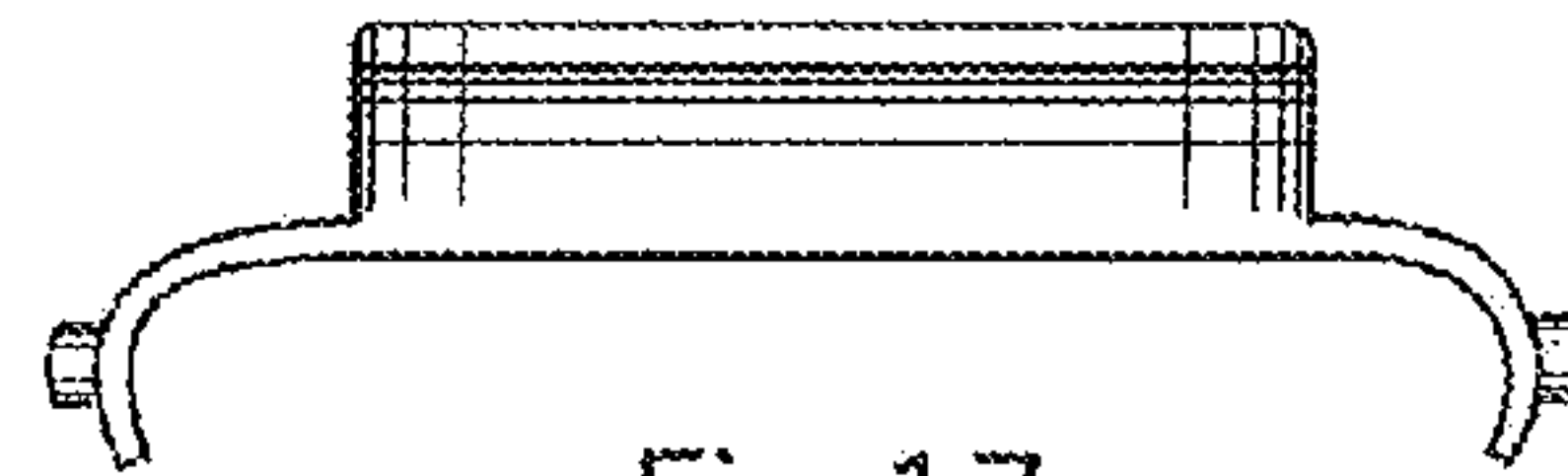

Fig 17

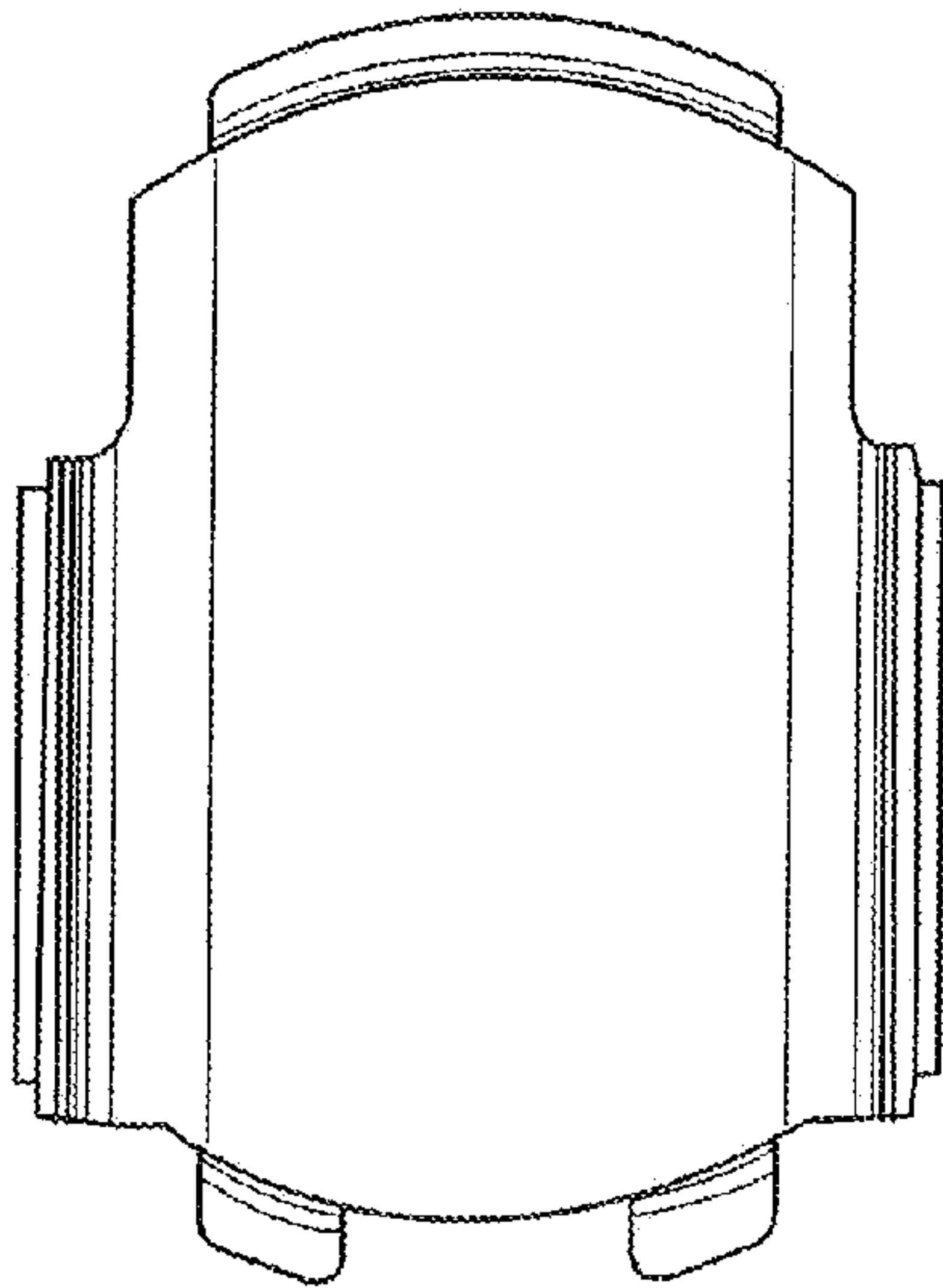

Fig 19

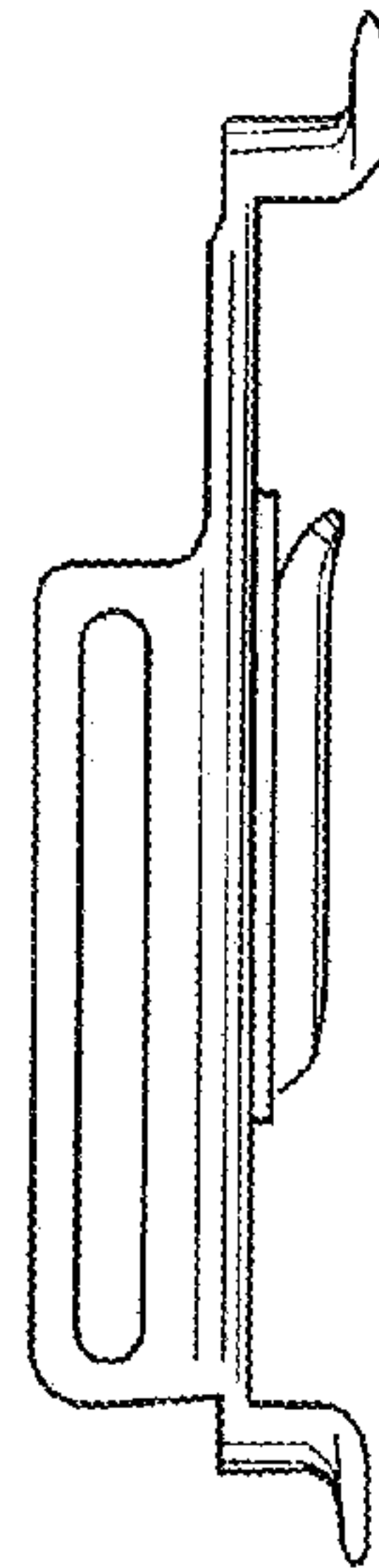

Fig 18

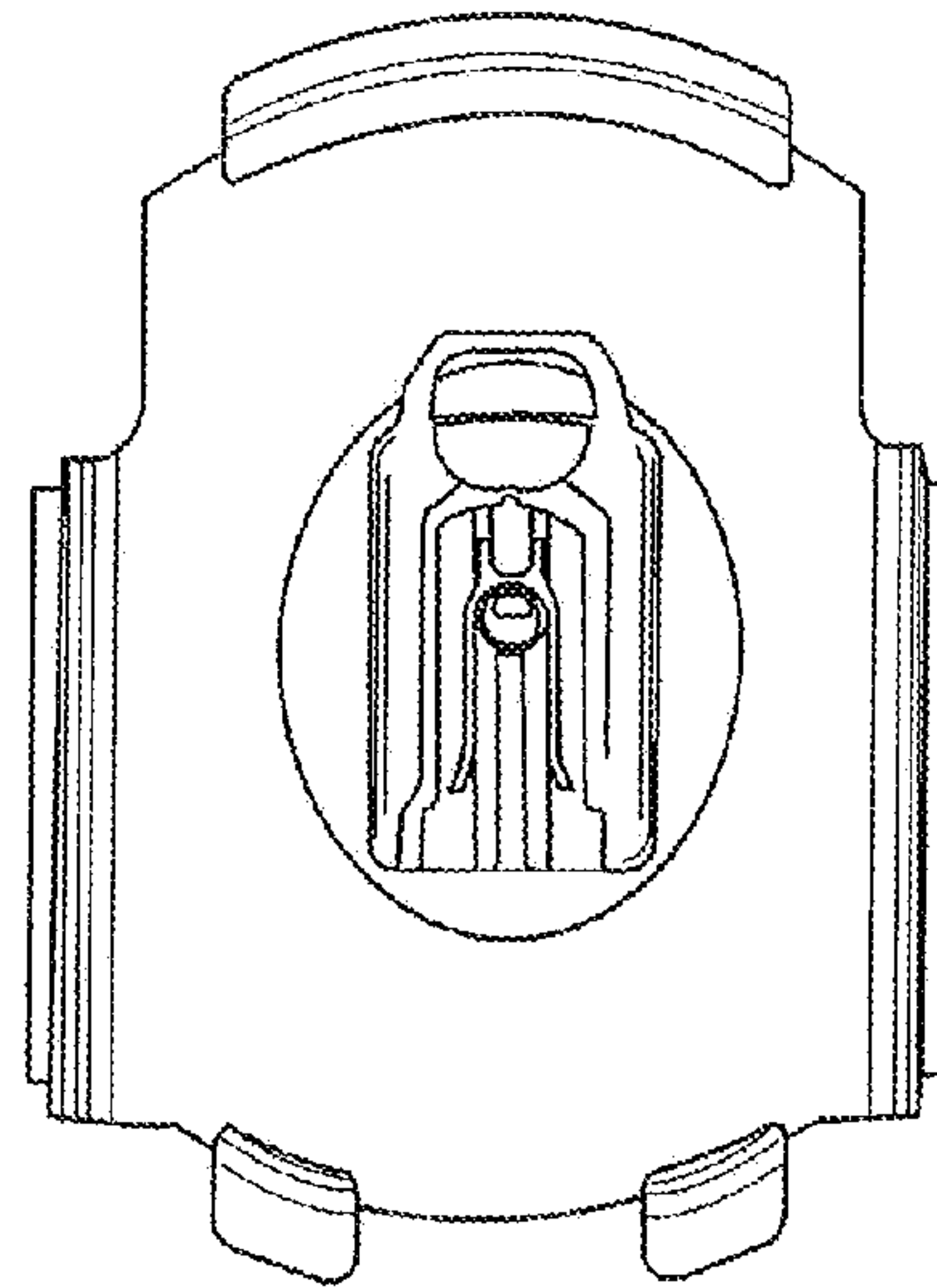

Fig 16

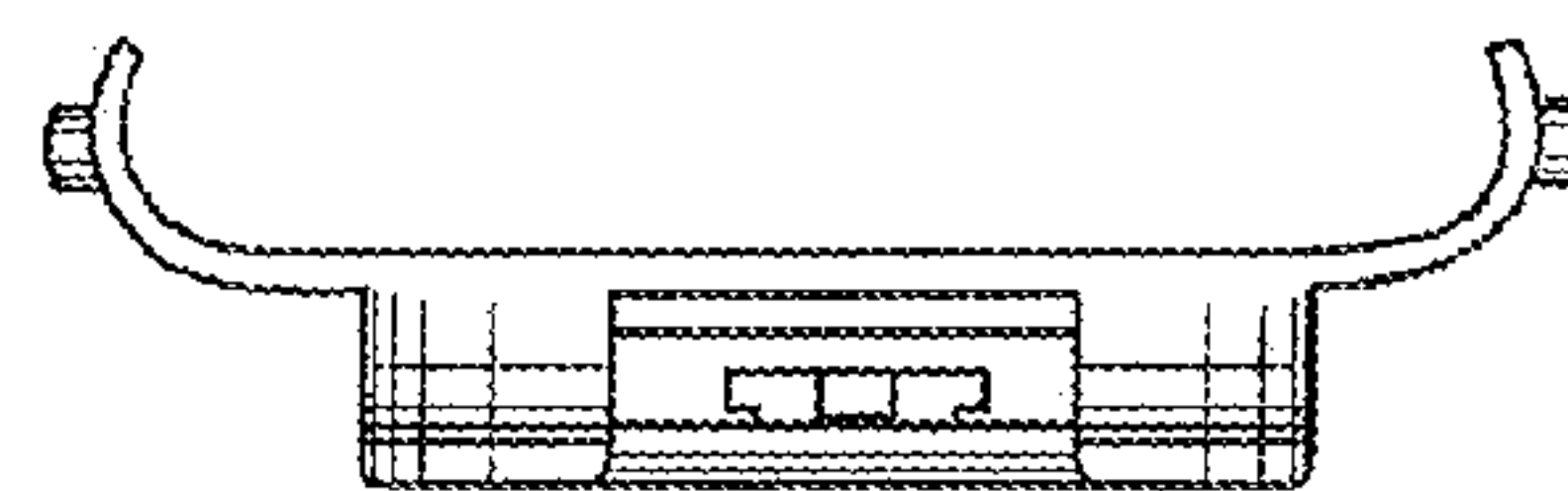

Fig 20

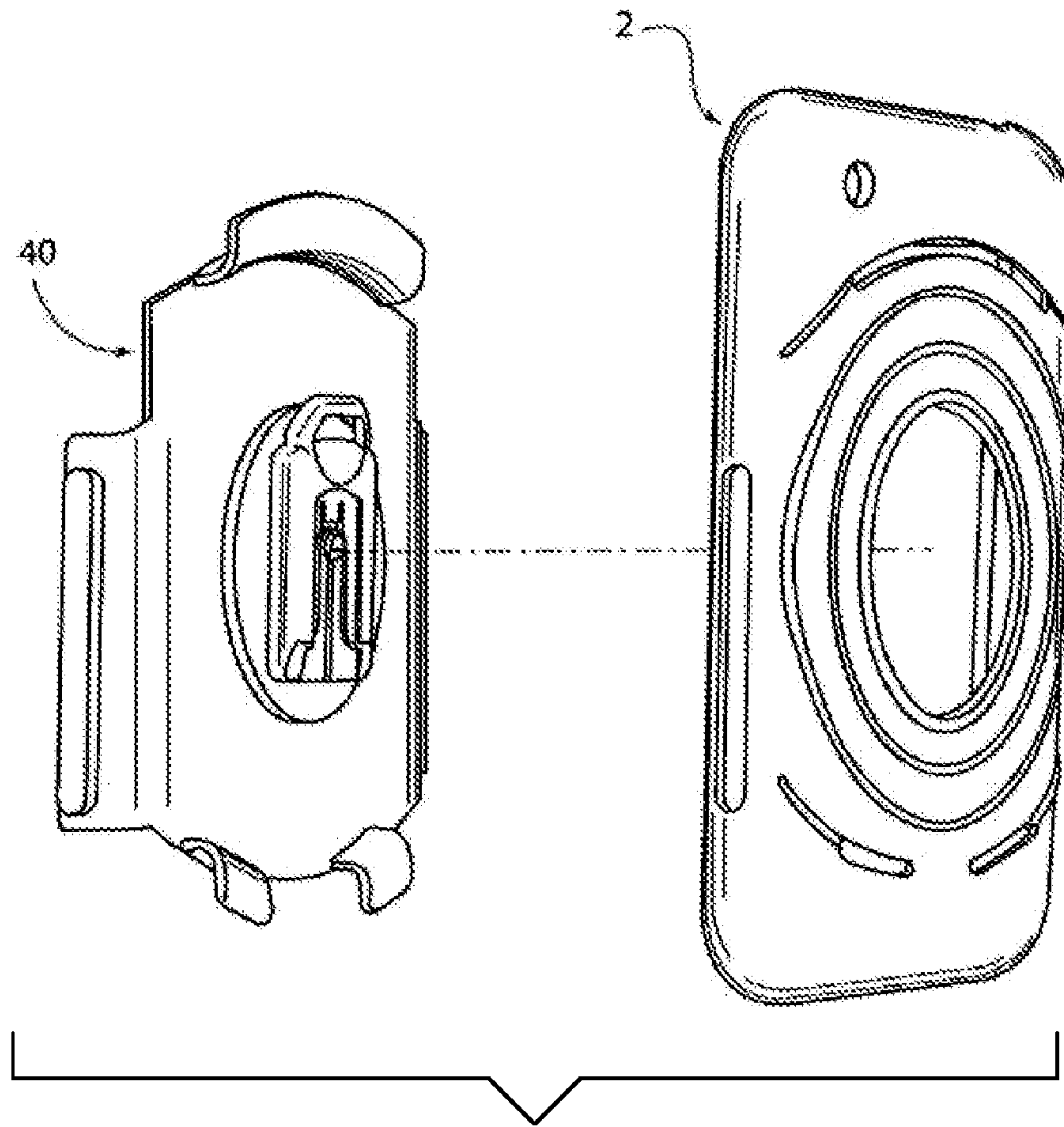

FIG. 21