



US00D565180S

(12) **United States Design Patent**
Liao

(10) **Patent No.:** **US D565,180 S**
(45) **Date of Patent:** **** Mar. 25, 2008**

(54) **DEVICE FOR BONE GRAFTING**

(76) Inventor: **Jung-Yen Liao**, No. 202, Fu-Chan Rd.,
Hua-Lien (TW)

(**) Term: **14 Years**

(21) Appl. No.: **29/270,803**

(22) Filed: **Jan. 3, 2007**

Related U.S. Application Data

(63) Continuation of application No. 10/886,854, filed on
Jul. 8, 2004, now abandoned.

(51) **LOC (8) Cl.** **24-03**

(52) **U.S. Cl.** **D24/155**

(58) **Field of Classification Search** D24/155,
D24/156; 606/61, 72, 74; 623/17.16, 17.17,
623/11.1; D8/387; 433/173

See application file for complete search history.

(56) **References Cited**

U.S. PATENT DOCUMENTS

D338,959	S	*	8/1993	Loof et al.	D24/156
D347,787	S	*	6/1994	Galmines et al.	D8/387
D390,099	S	*	2/1998	Bailey et al.	D8/387
5,800,436	A	*	9/1998	Lerch	606/72
D399,562	S	*	10/1998	Mendoza	D24/156
D399,563	S	*	10/1998	Mendoza	D24/156
5,931,838	A	*	8/1999	Vito	606/61
6,102,914	A	*	8/2000	Bulstra et al.	606/72
6,743,232	B2	*	6/2004	Overaker et al.	606/72
D517,404	S	*	3/2006	Schluter	D8/387
D521,642	S	*	5/2006	Dorahy	D24/155

* cited by examiner

Primary Examiner—Charles A. Rademaker
(74) *Attorney, Agent, or Firm*—Bucknam & Archer

(57) **CLAIM**

The ornamental design for a device for bone grafting, as shown and described.

DESCRIPTION

FIG. 1 is a top perspective view of a device for bone grafting showing my new design;

FIG. 2 is a front elevation thereof, the side opposite being identical;

FIG. 3 is a side elevation thereof;

FIG. 4 is a top plan view thereof;

FIG. 5 is a bottom plan view thereof;

FIG. 6 is another front elevation thereof;

FIG. 7 is a cross-sectional view thereof;

FIG. 8 is a top perspective view of a modified embodiment of the design shown in FIGS. 1 through 7;

FIG. 9 is a front elevation thereof, the side opposite being a mirror image thereof;

FIG. 10 is a side elevation thereof;

FIG. 11 is a top plan view thereof;

FIG. 12 is a bottom plan view thereof;

FIG. 13 is another front elevation thereof; and,

FIG. 14 is a cross-sectional view thereof.

The broken lines shown in the drawings are included for the purpose of illustrating environmental structures and form no part of the claimed design.

1 Claim, 4 Drawing Sheets

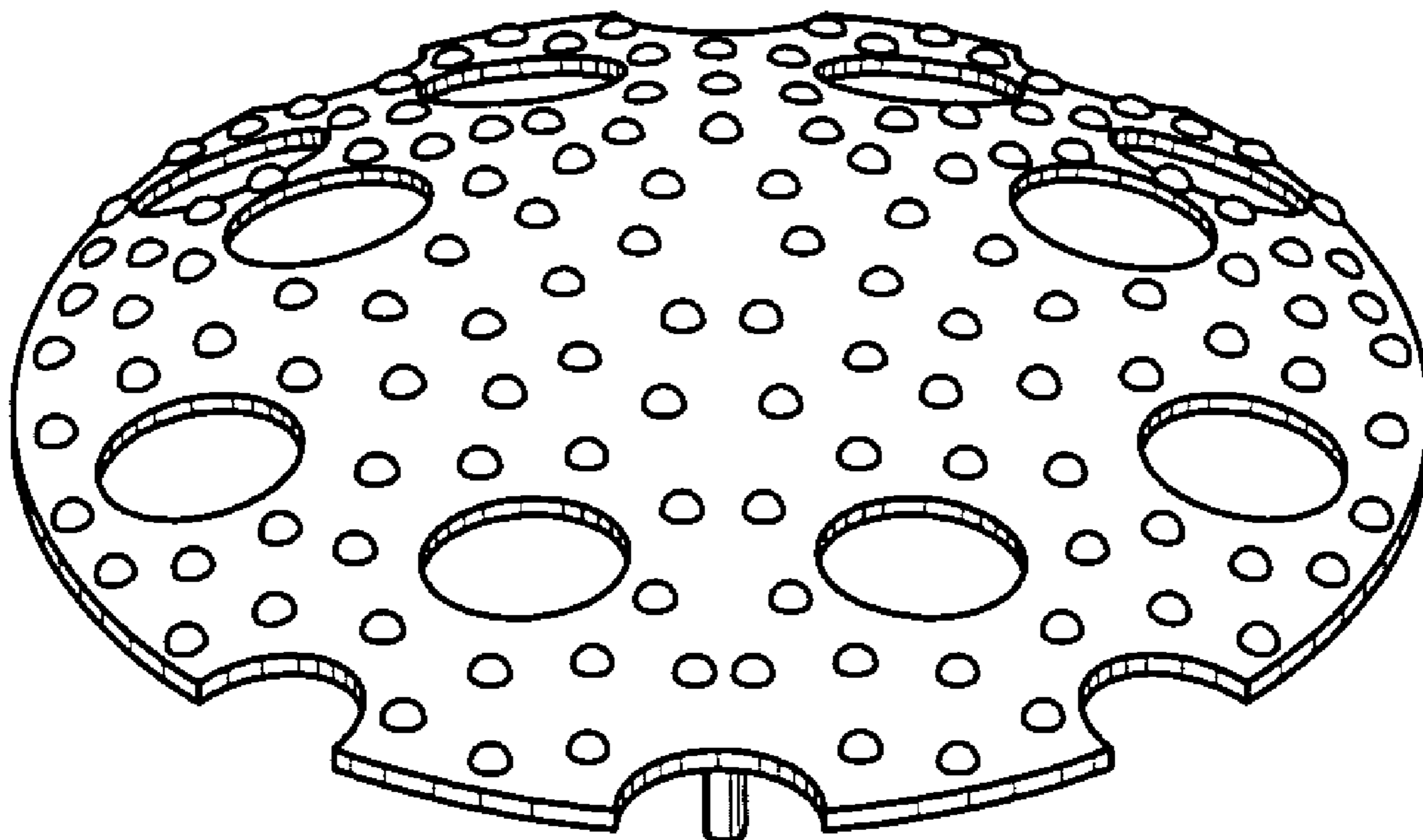

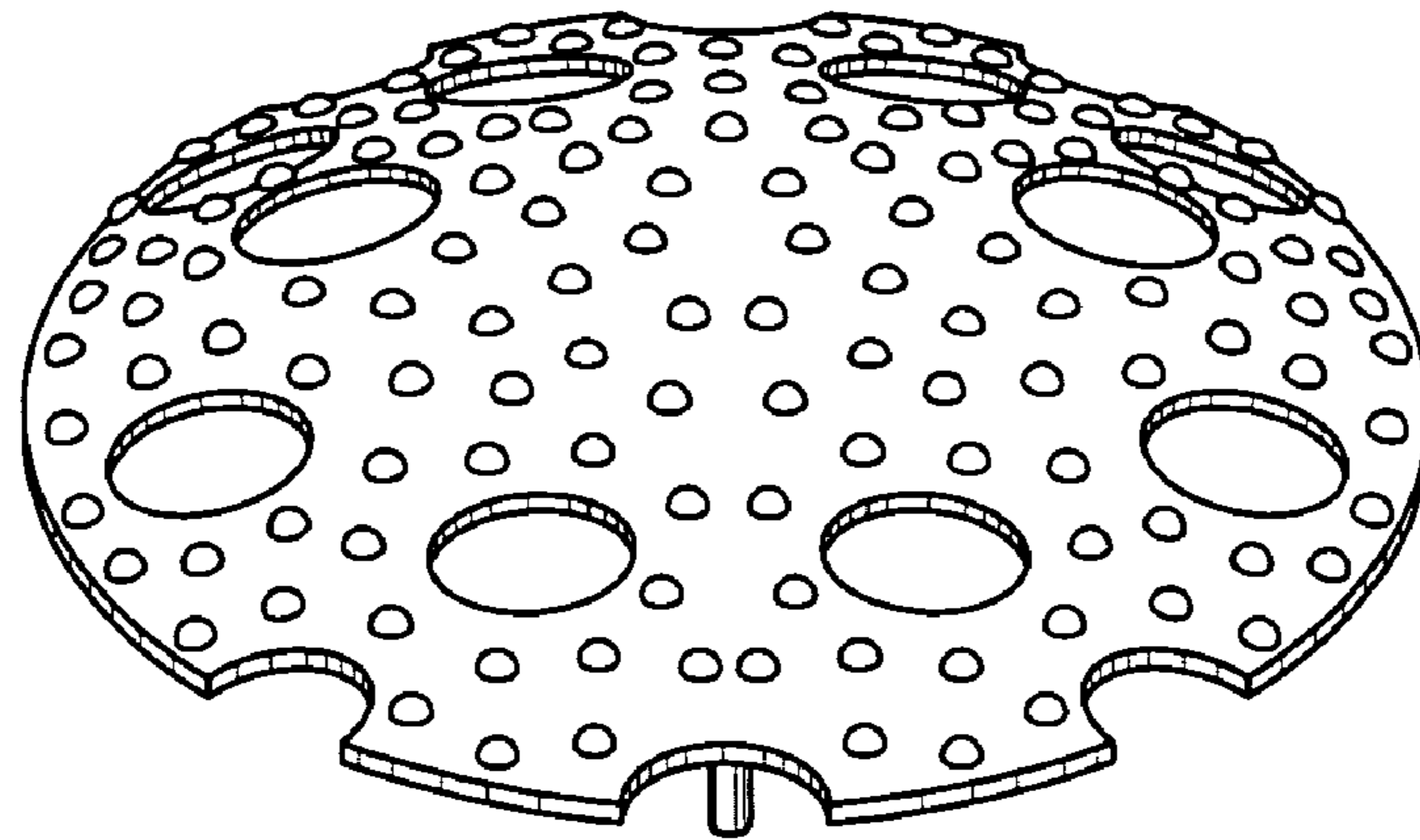

FIG. 1

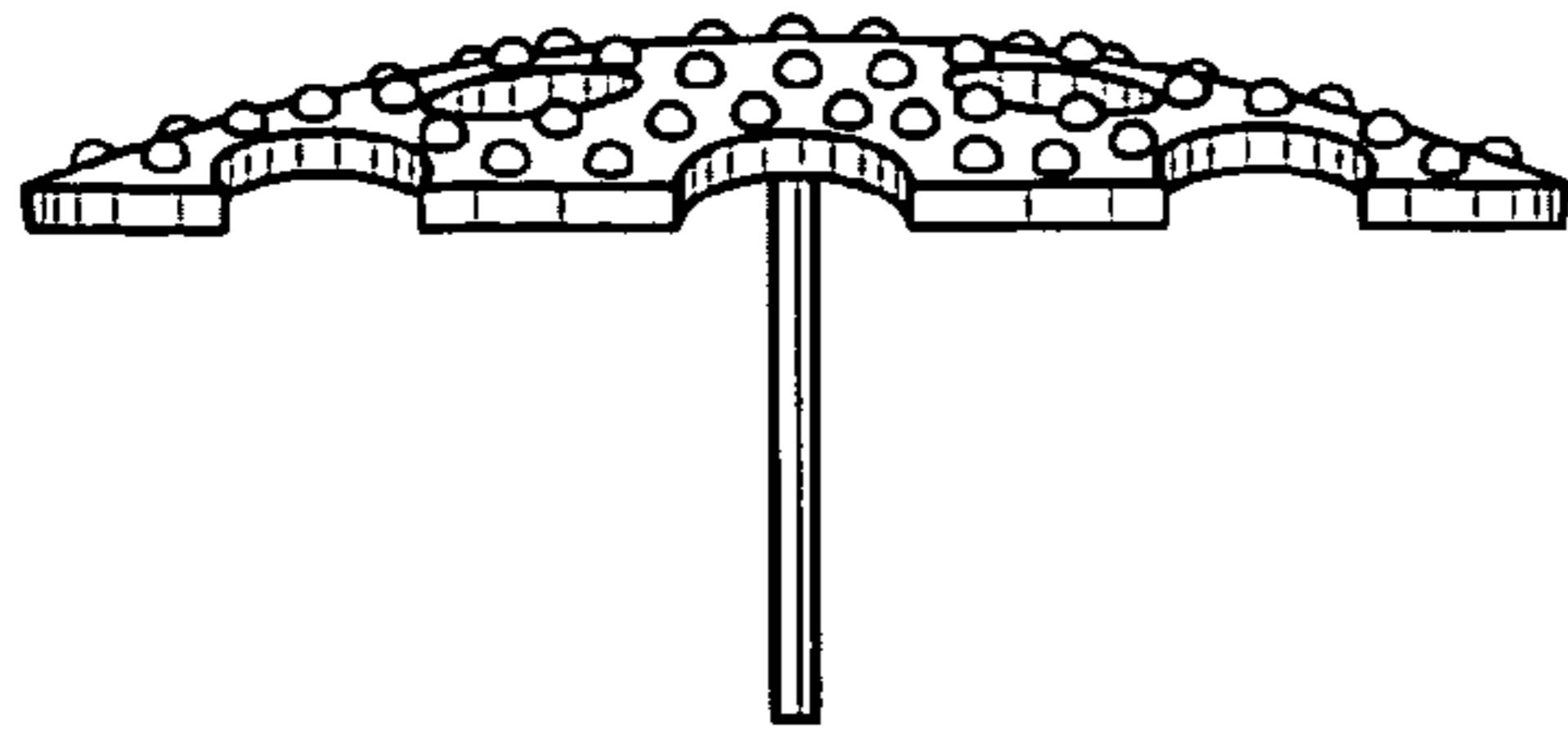

FIG. 2

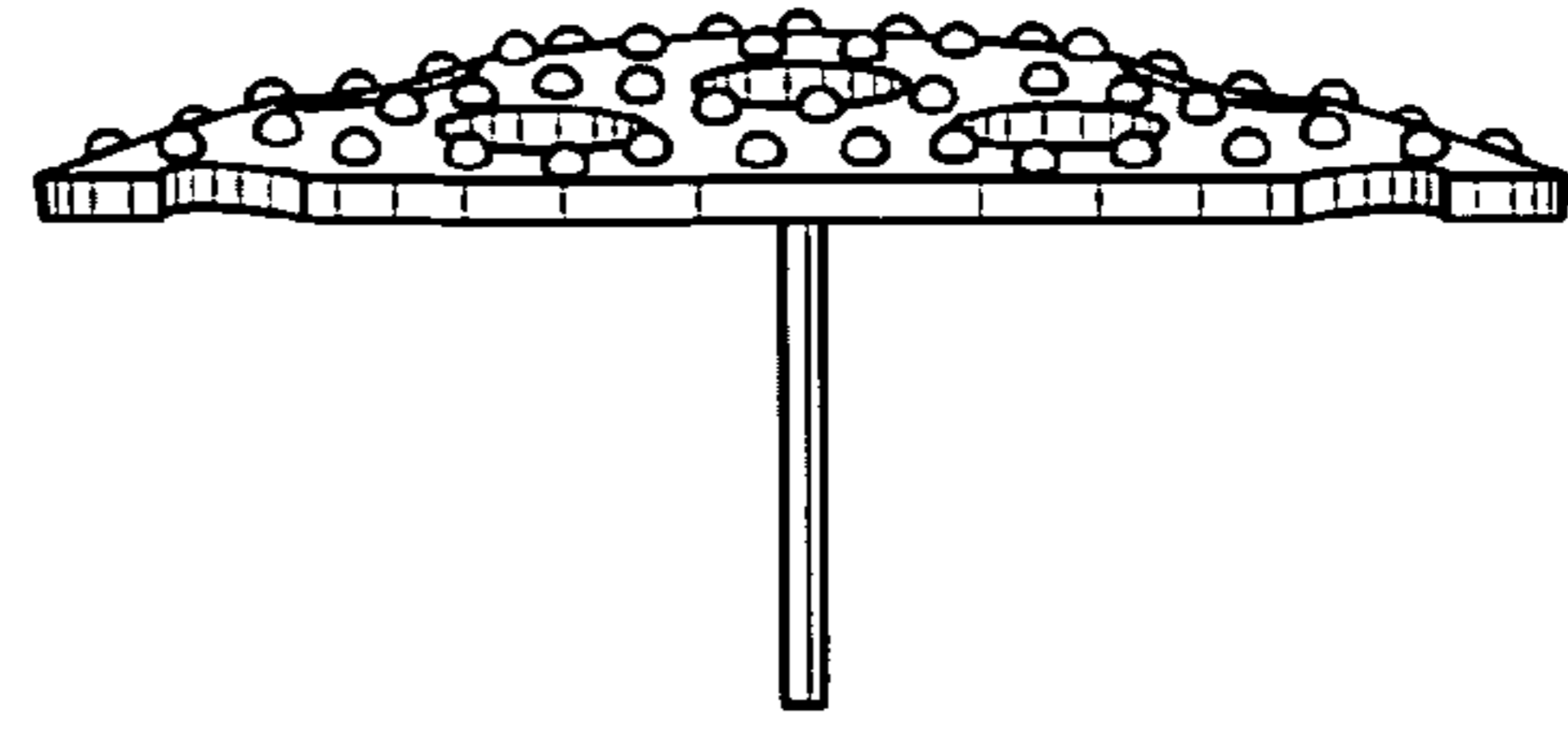

FIG. 3

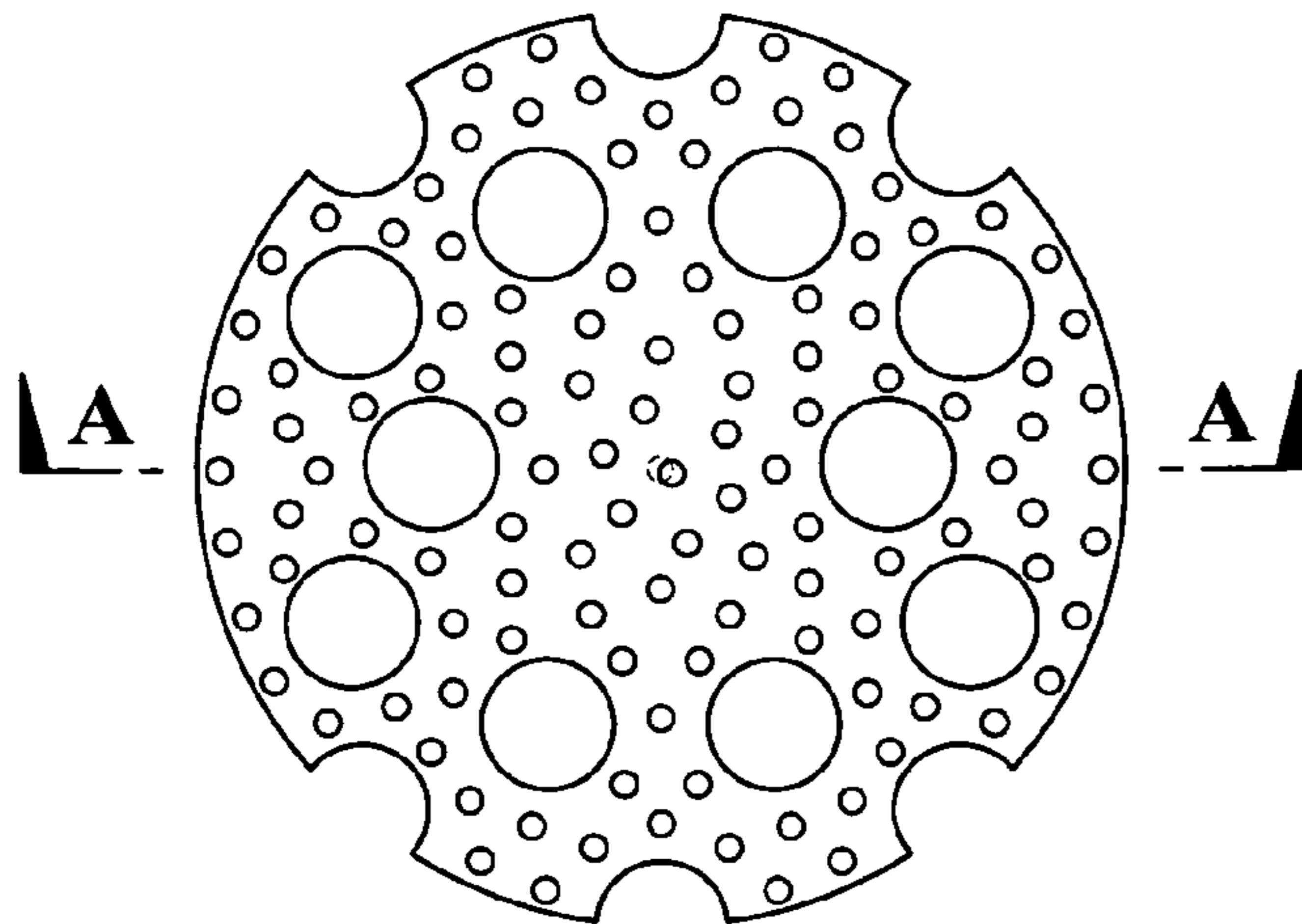

FIG. 4

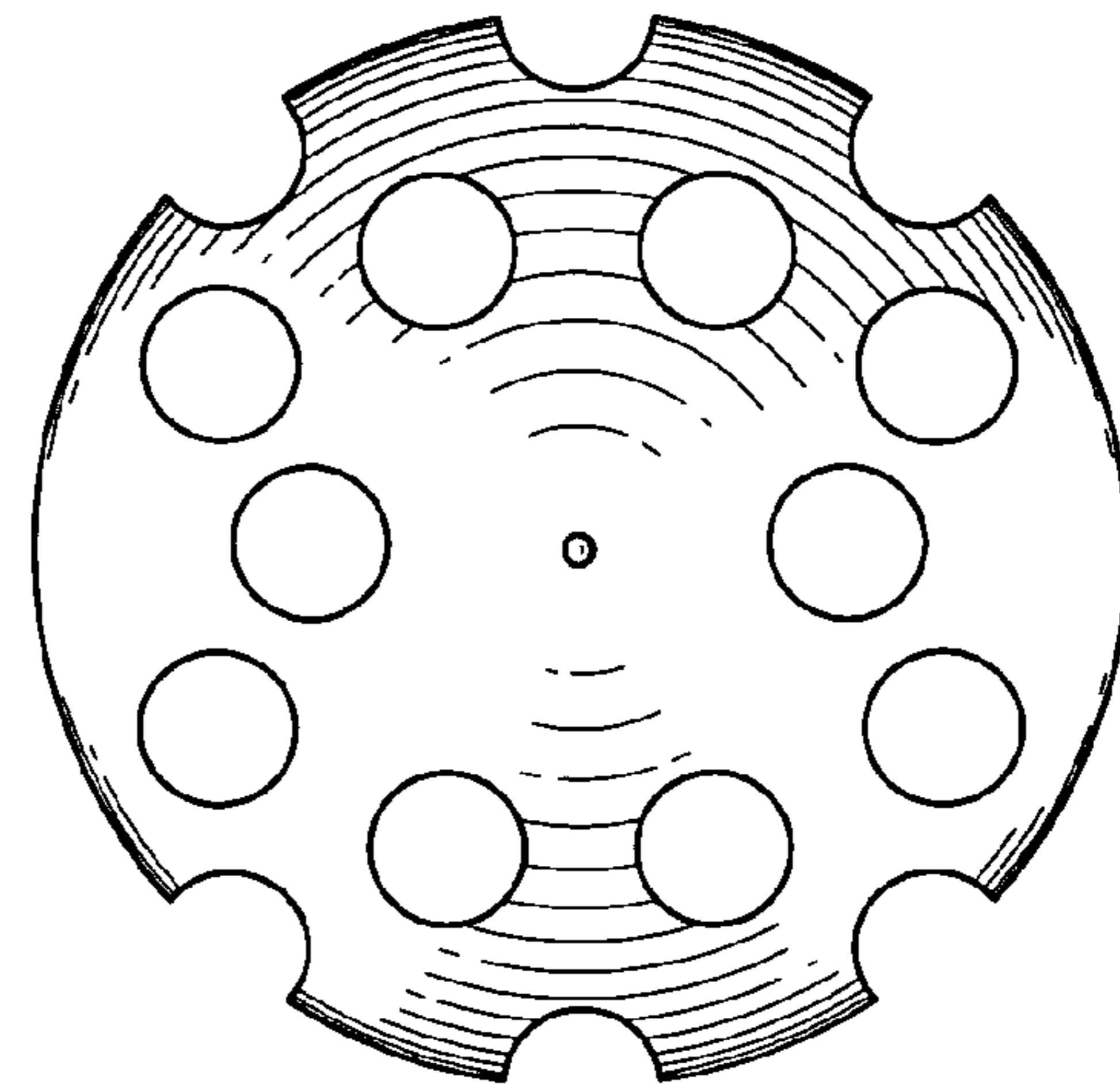

FIG. 5

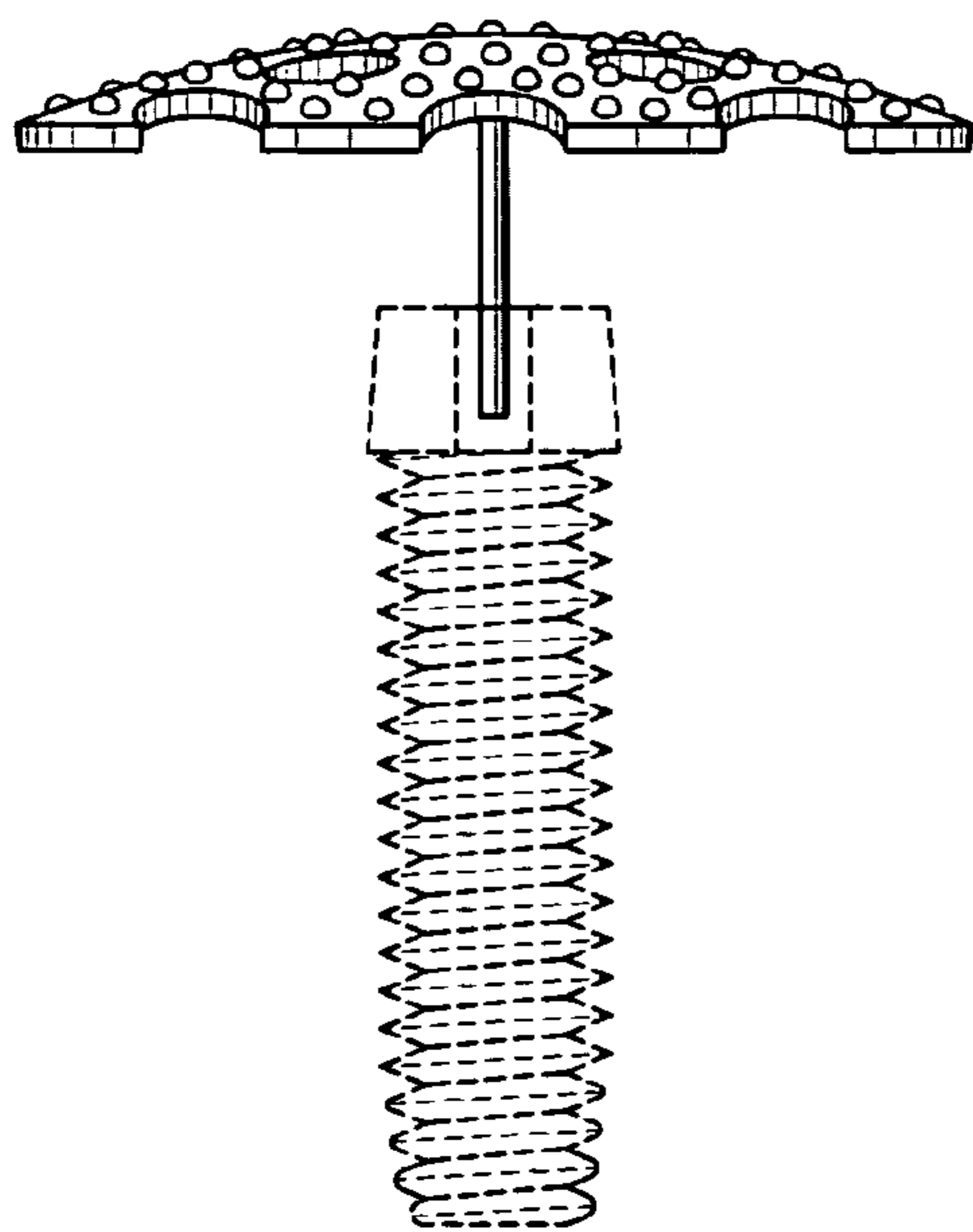

FIG. 6

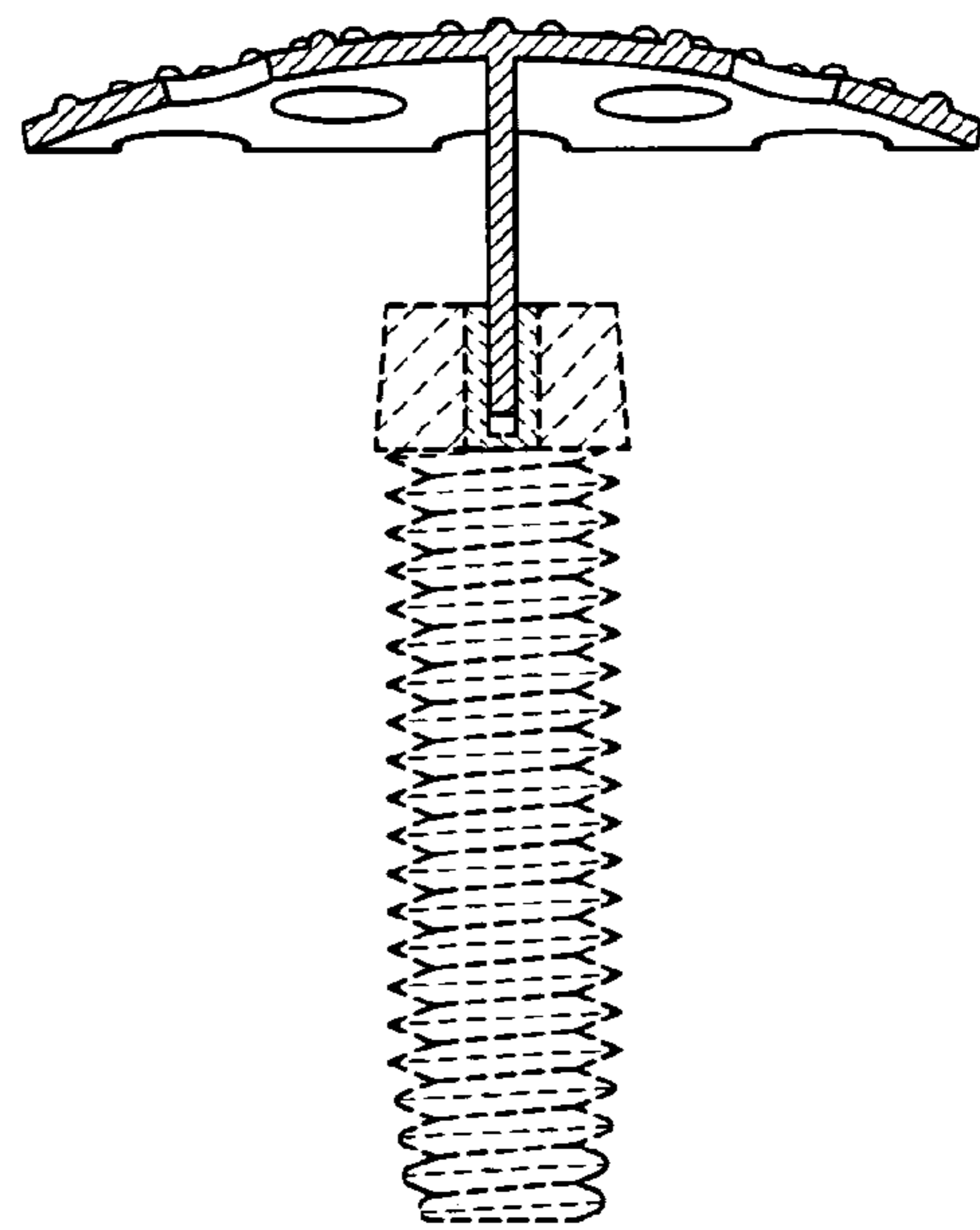

FIG. 7

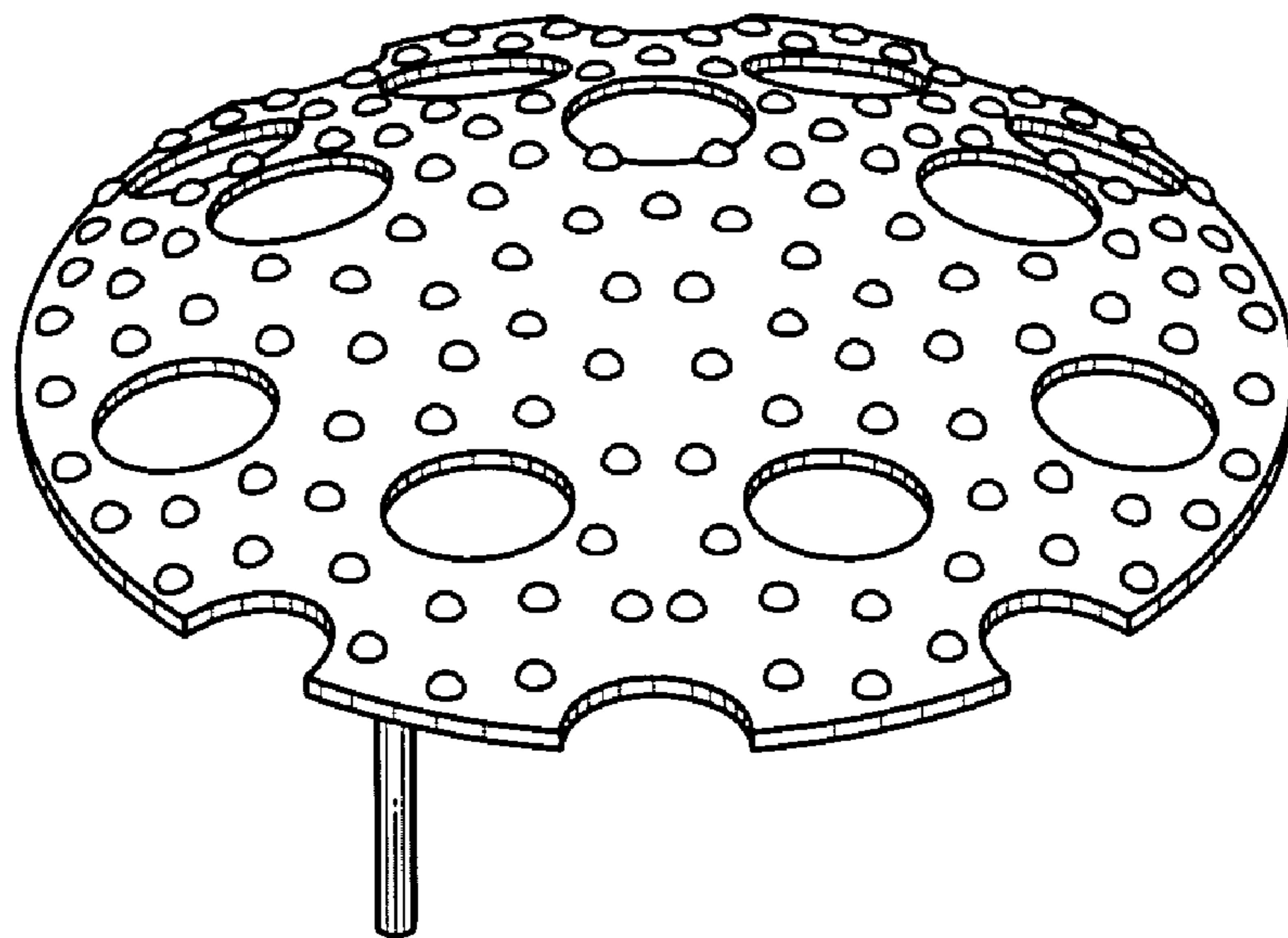

FIG. 8

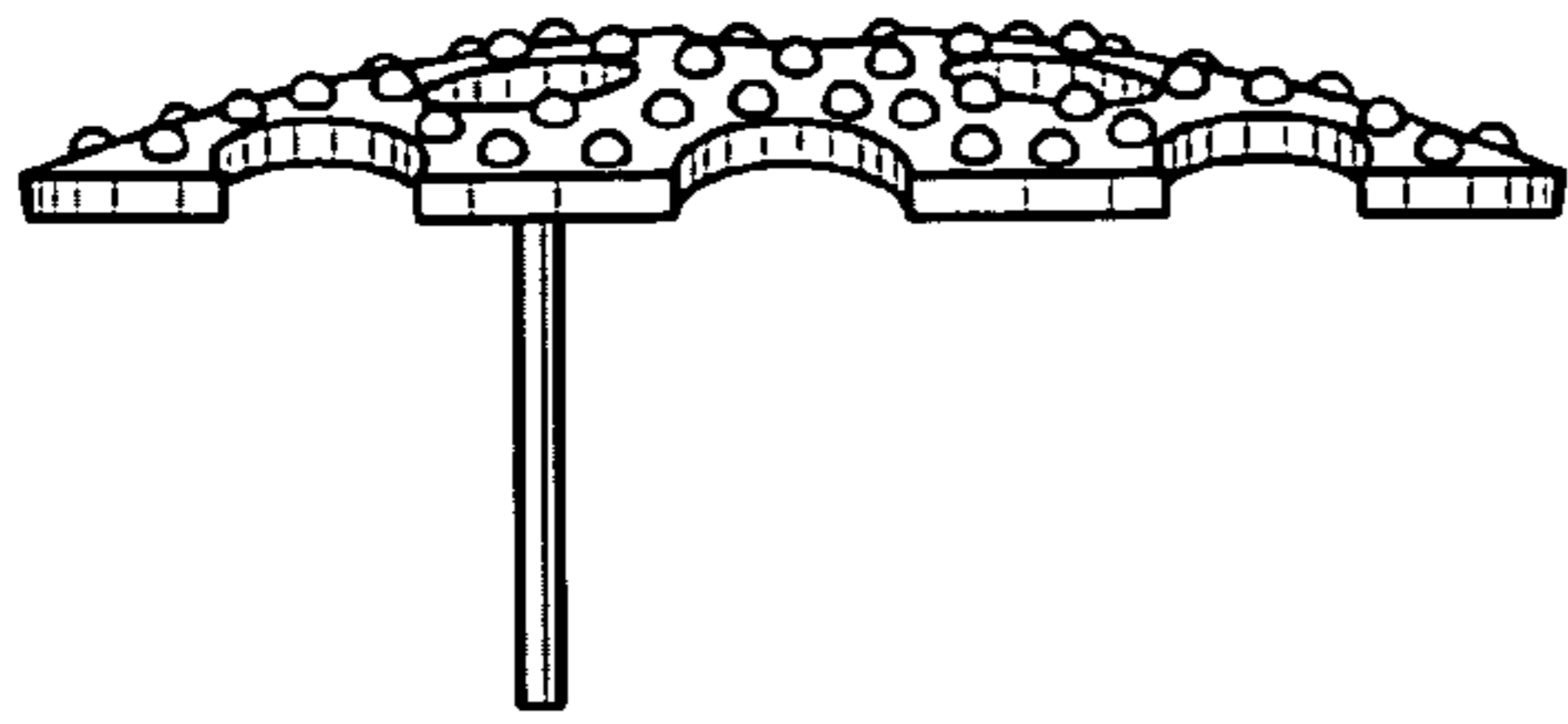

FIG. 9

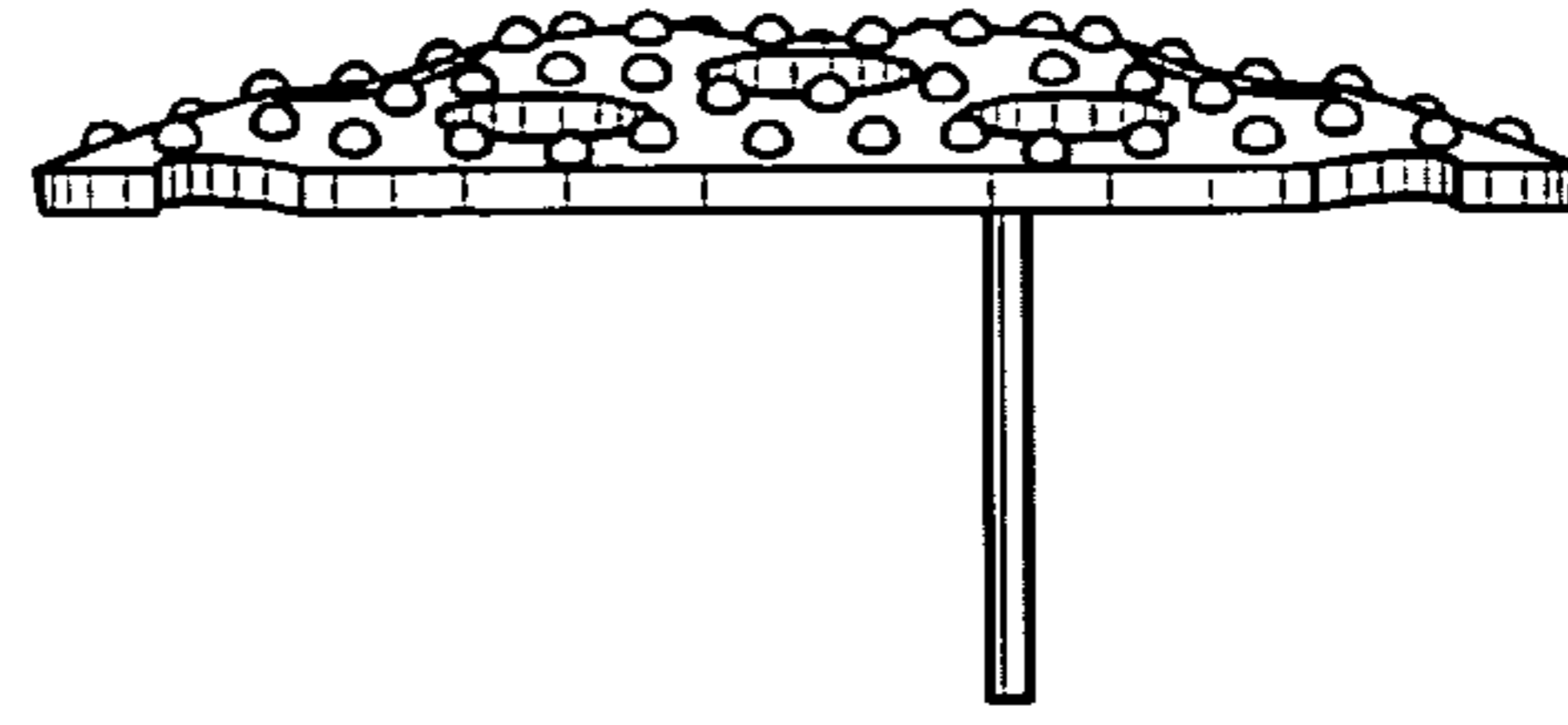

FIG. 10

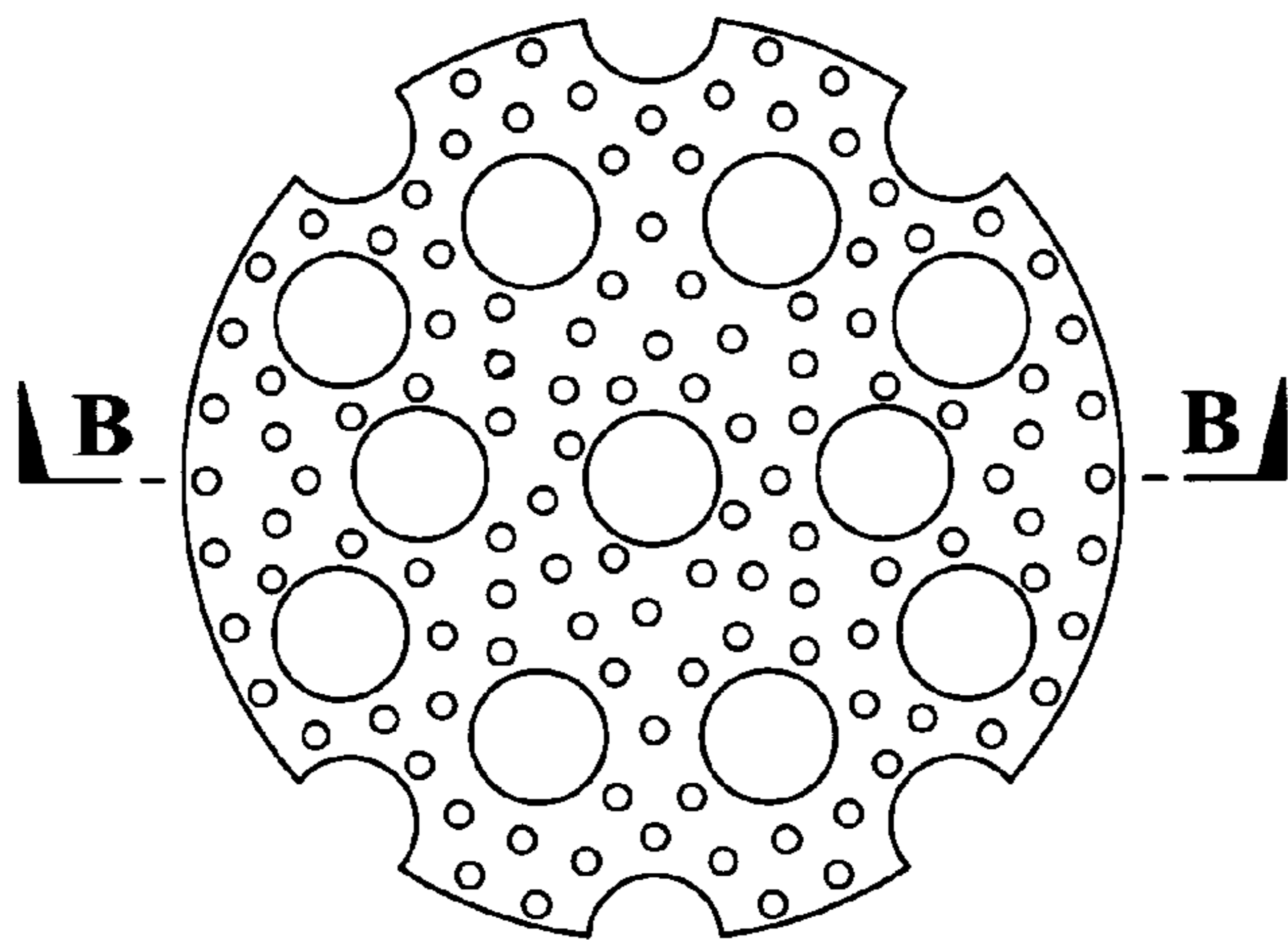

FIG. 11

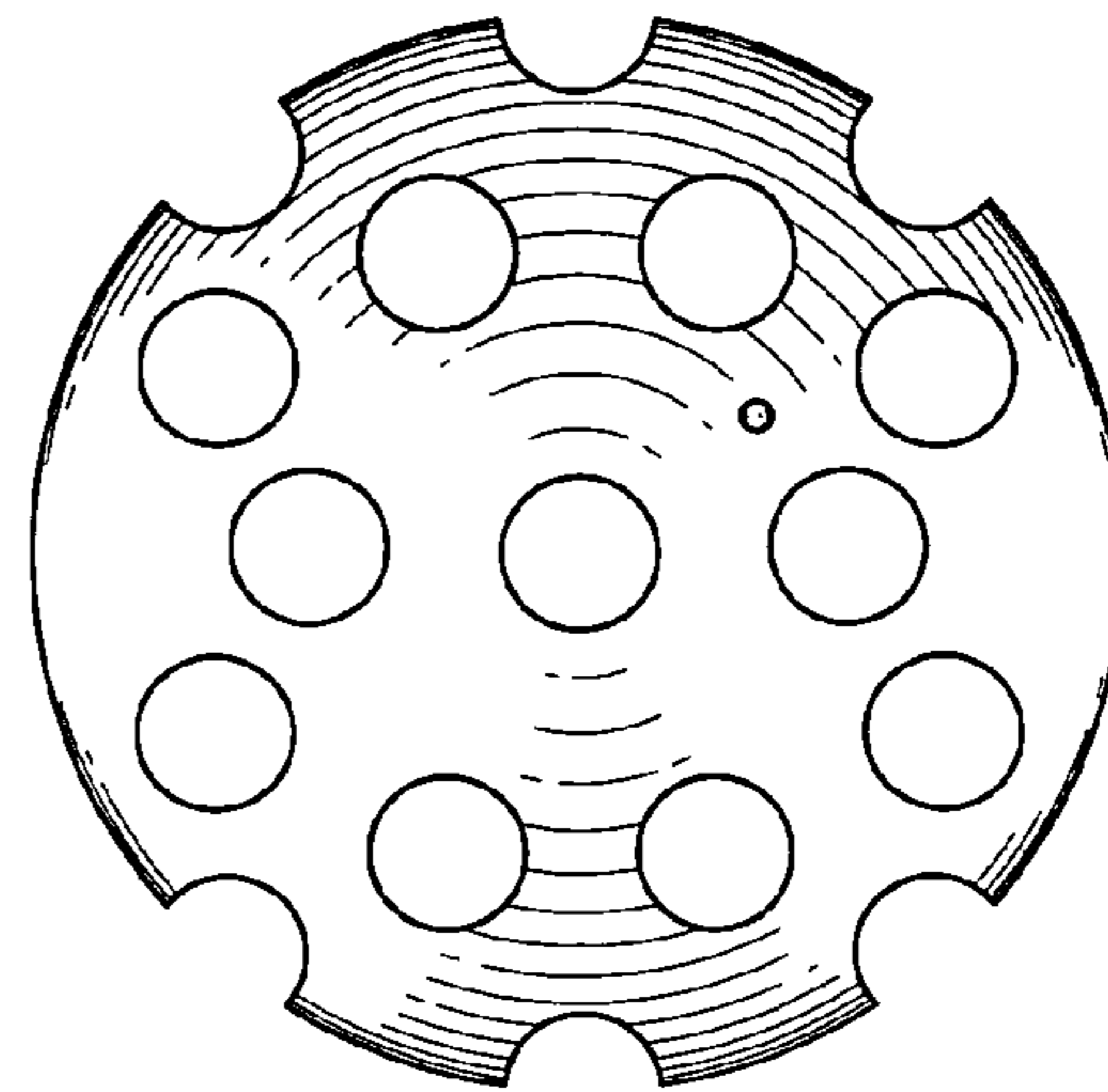

FIG. 12

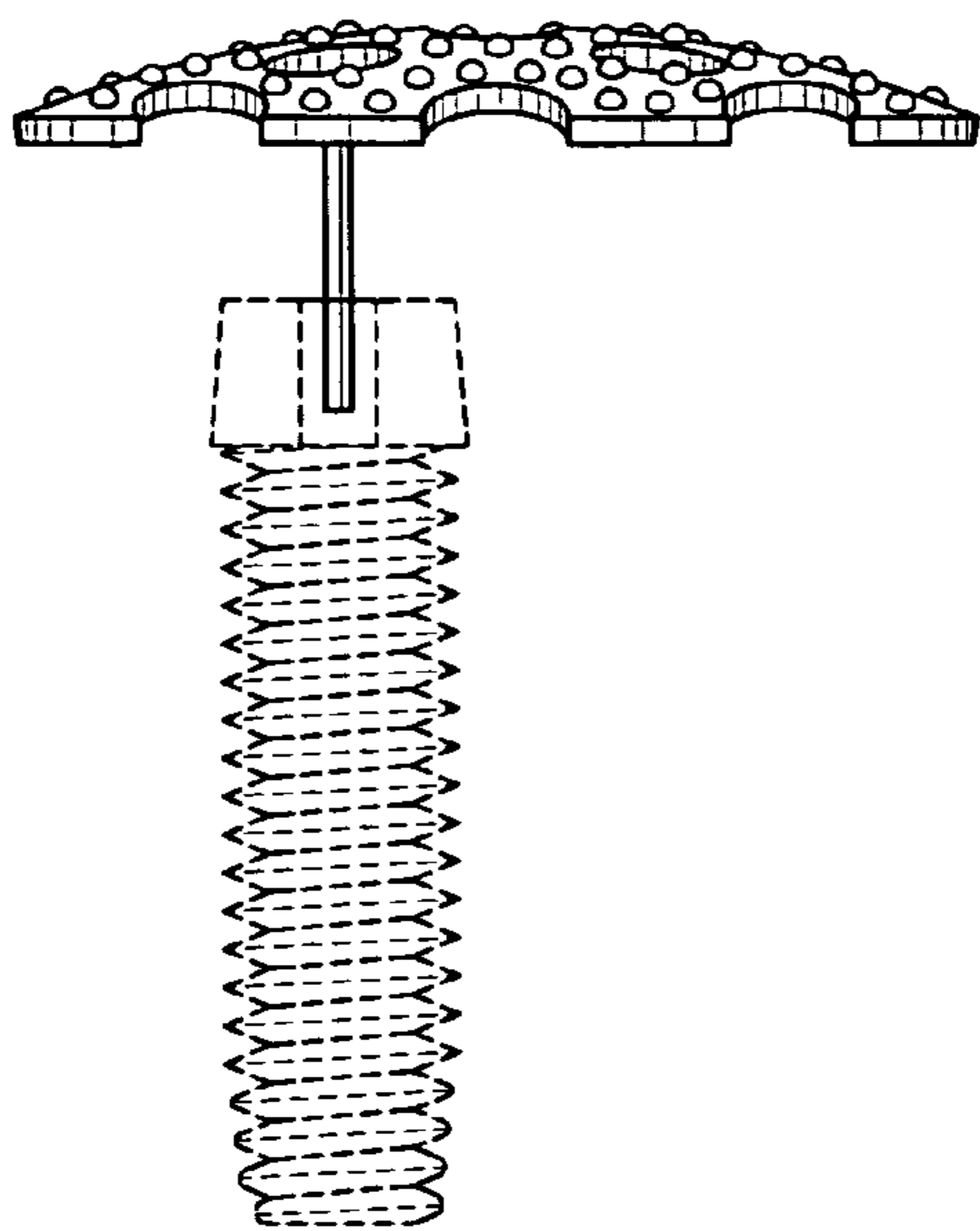

FIG. 13

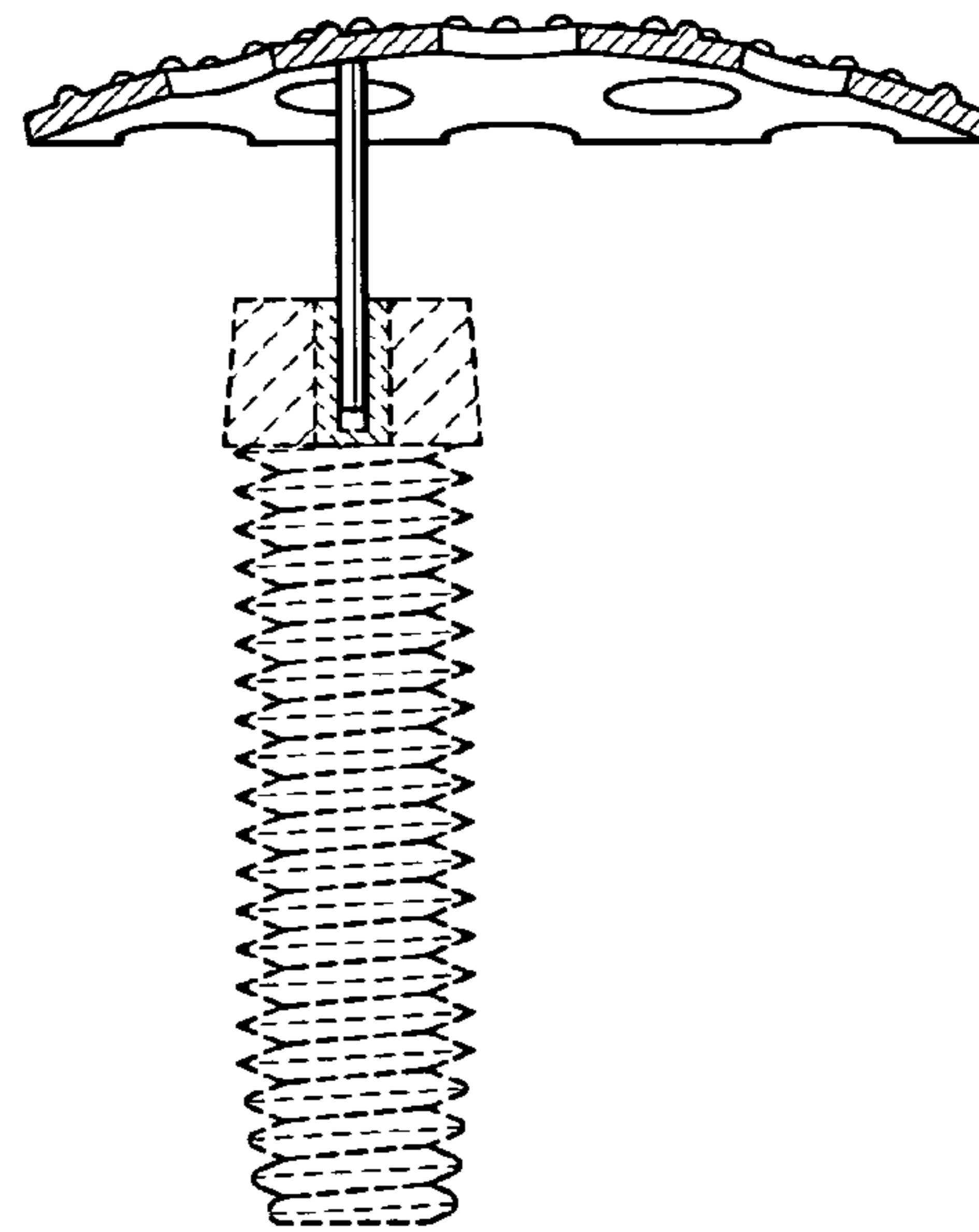

FIG. 14