

US00D565086S

(12) **United States Design Patent**
Arnette

(10) **Patent No.:** **US D565,086 S**

(45) **Date of Patent:** **** Mar. 25, 2008**

(54) **SUNGLASSES**

(76) **Inventor:** **Kip Arnette**, 104 Monarch Dr., Dana Point, CA (US) 92629

(**) **Term:** **14 Years**

(21) **Appl. No.:** **29/251,766**

(22) **Filed:** **Jan. 12, 2006**

(51) **LOC (8) Cl.** **16-06**

(52) **U.S. Cl.** **D16/326; D16/313**

(58) **Field of Classification Search** D16/300-330,
D16/101, 332-338; D29/109-110; D24/110.2;
351/41, 44, 51-52, 62, 158, 92, 103-111,
351/156, 61, 114-119, 121-123; 2/426-432,
2/447-449, 441, 434-437

See application file for complete search history.

(56) **References Cited**

U.S. PATENT DOCUMENTS

D211,496 S * 6/1968 Mitchell D16/316

5,026,150 A * 6/1991 Weber 351/47
D410,666 S * 6/1999 Hall et al. D16/315
D445,821 S * 7/2001 Agnoli D16/327

* cited by examiner

Primary Examiner—Raphael Barkai

(57) **CLAIM**

The ornamental design for the sunglasses, as shown and described.

DESCRIPTION

FIG. 1 is a top, front and right side perspective view of the sunglasses, showing my new design in full lines;

FIG. 2 is a top view thereof;

FIG. 3 is a front view thereof;

FIG. 4 is a side view thereof;

FIG. 5 is a bottom view thereof; and,

FIG. 6 is a rear view thereof.

1 Claim, 4 Drawing Sheets

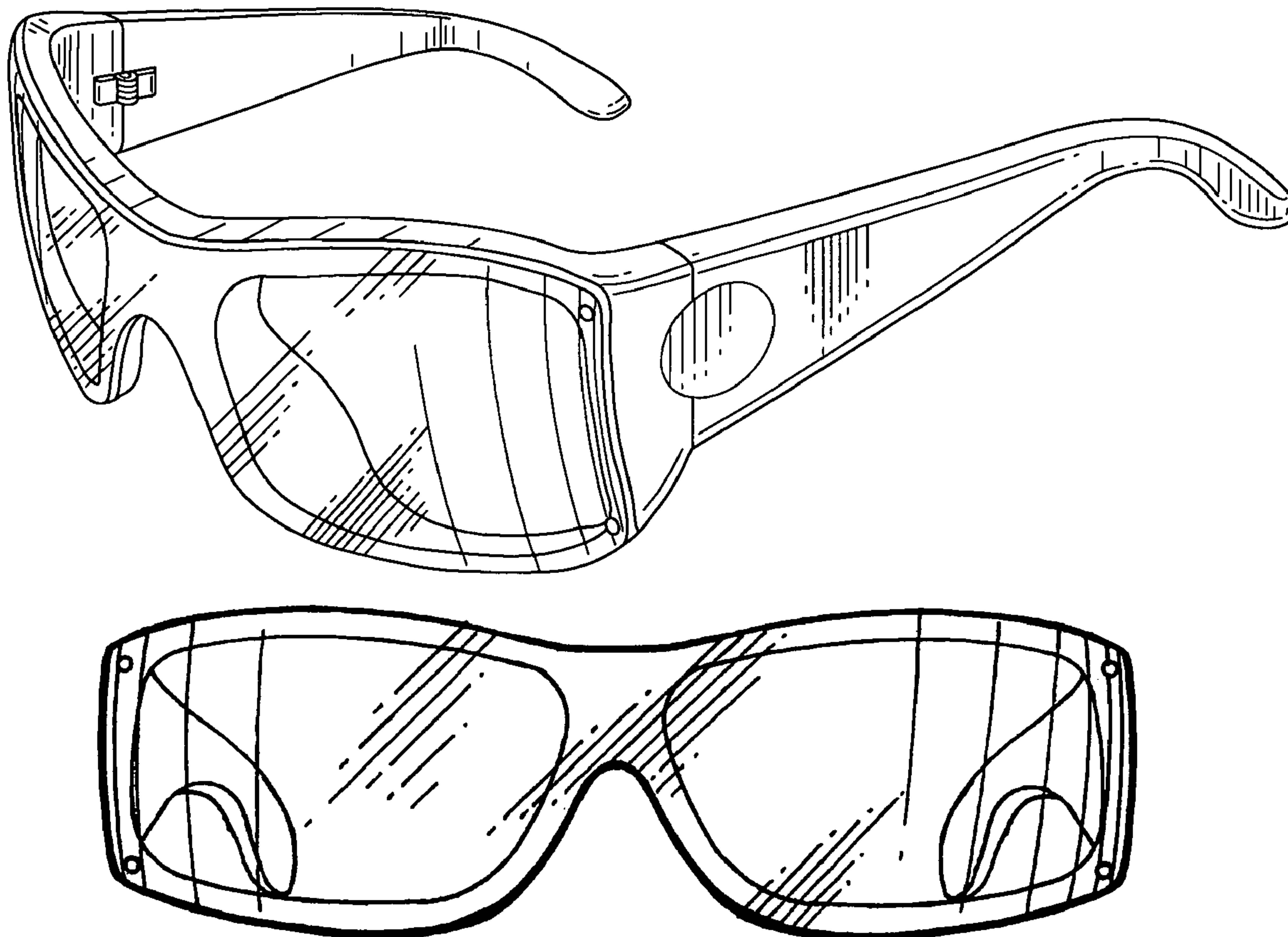

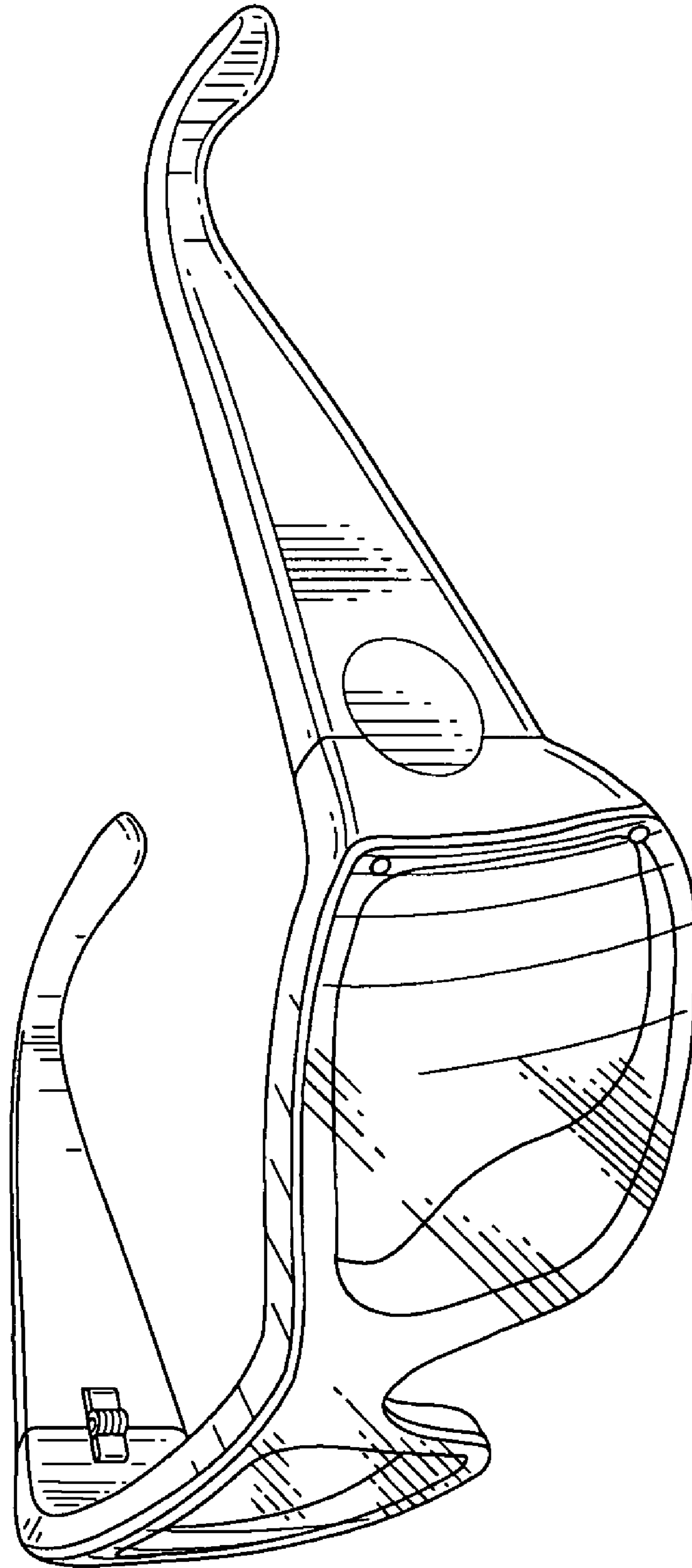

FIG. 1

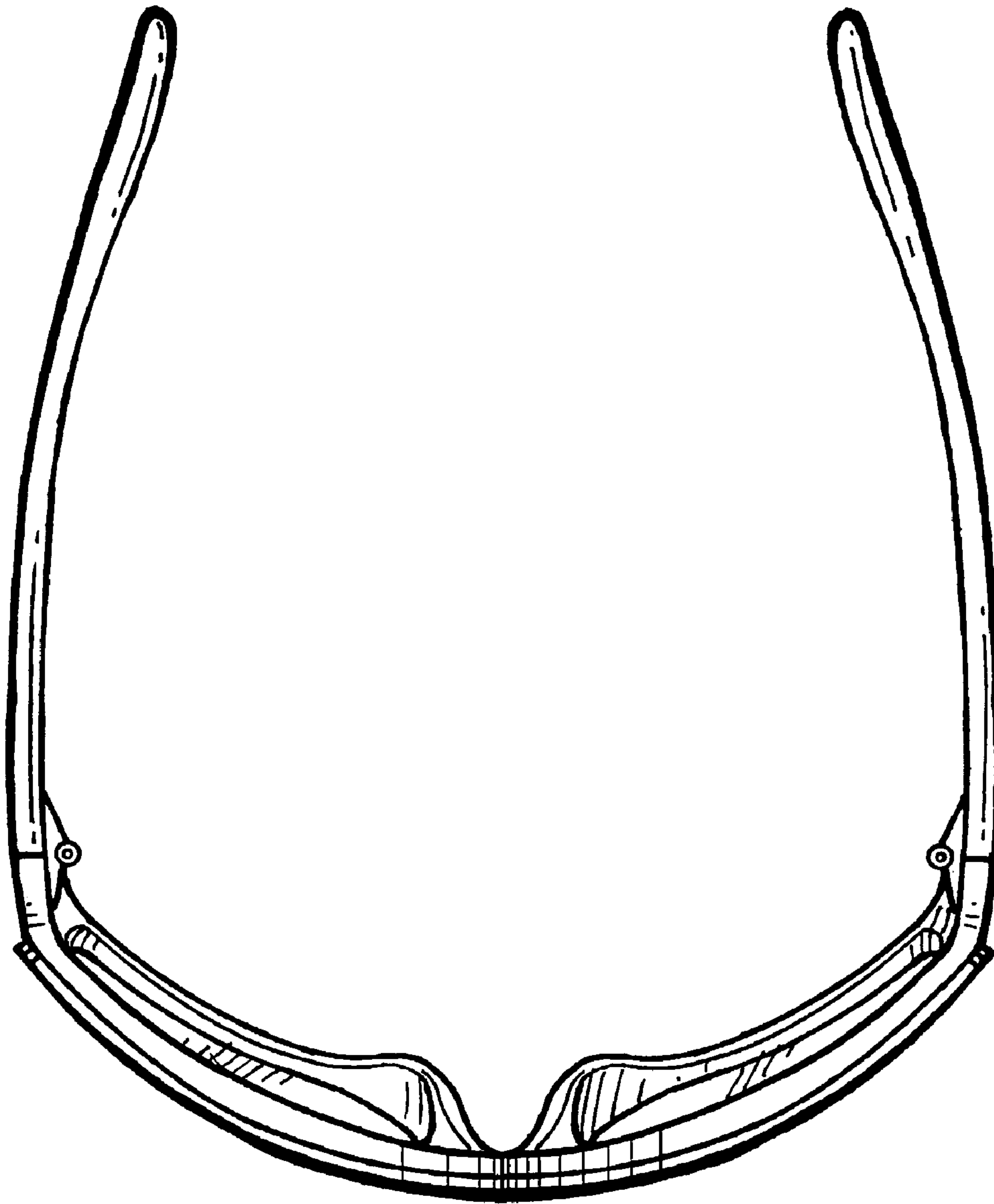

FIG. 2

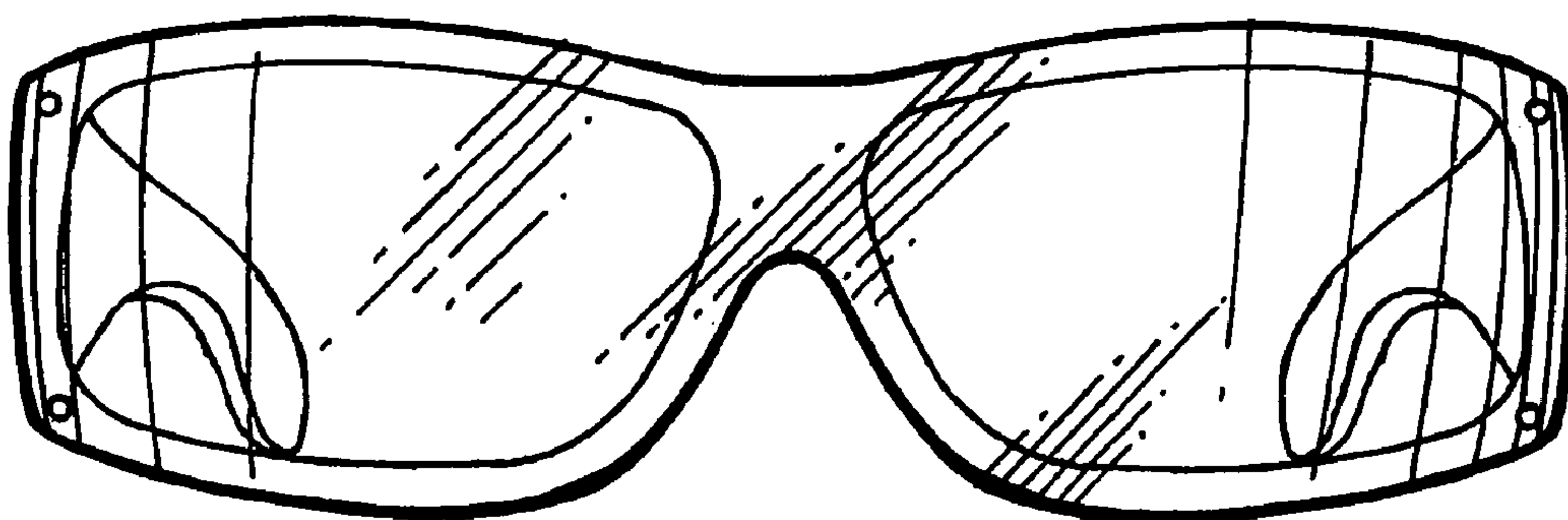

FIG. 3

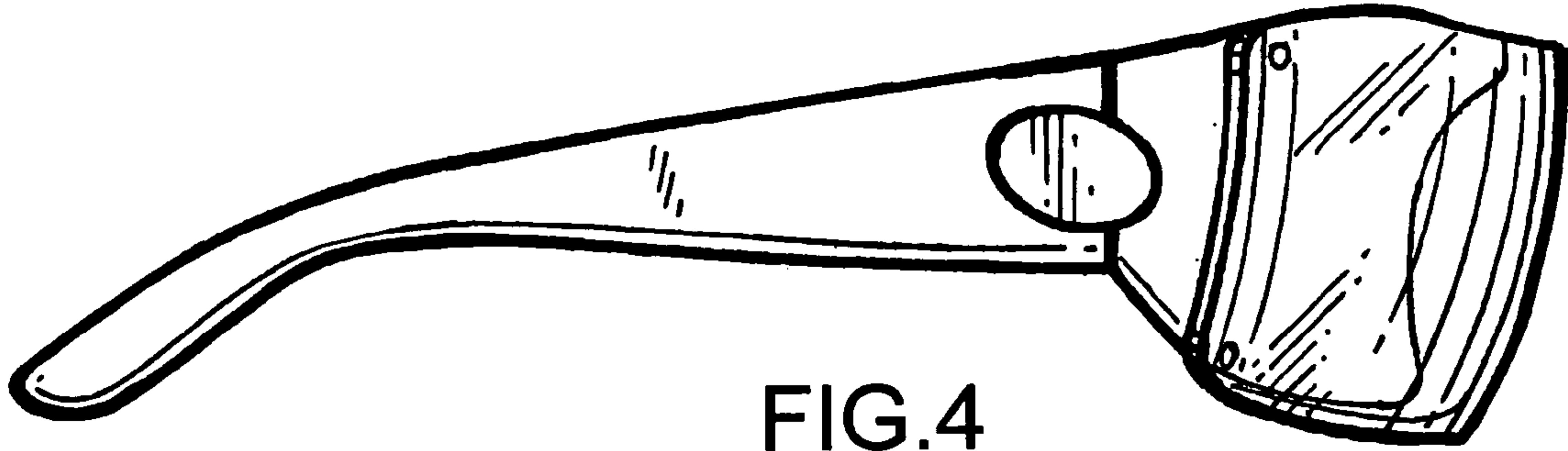

FIG. 4

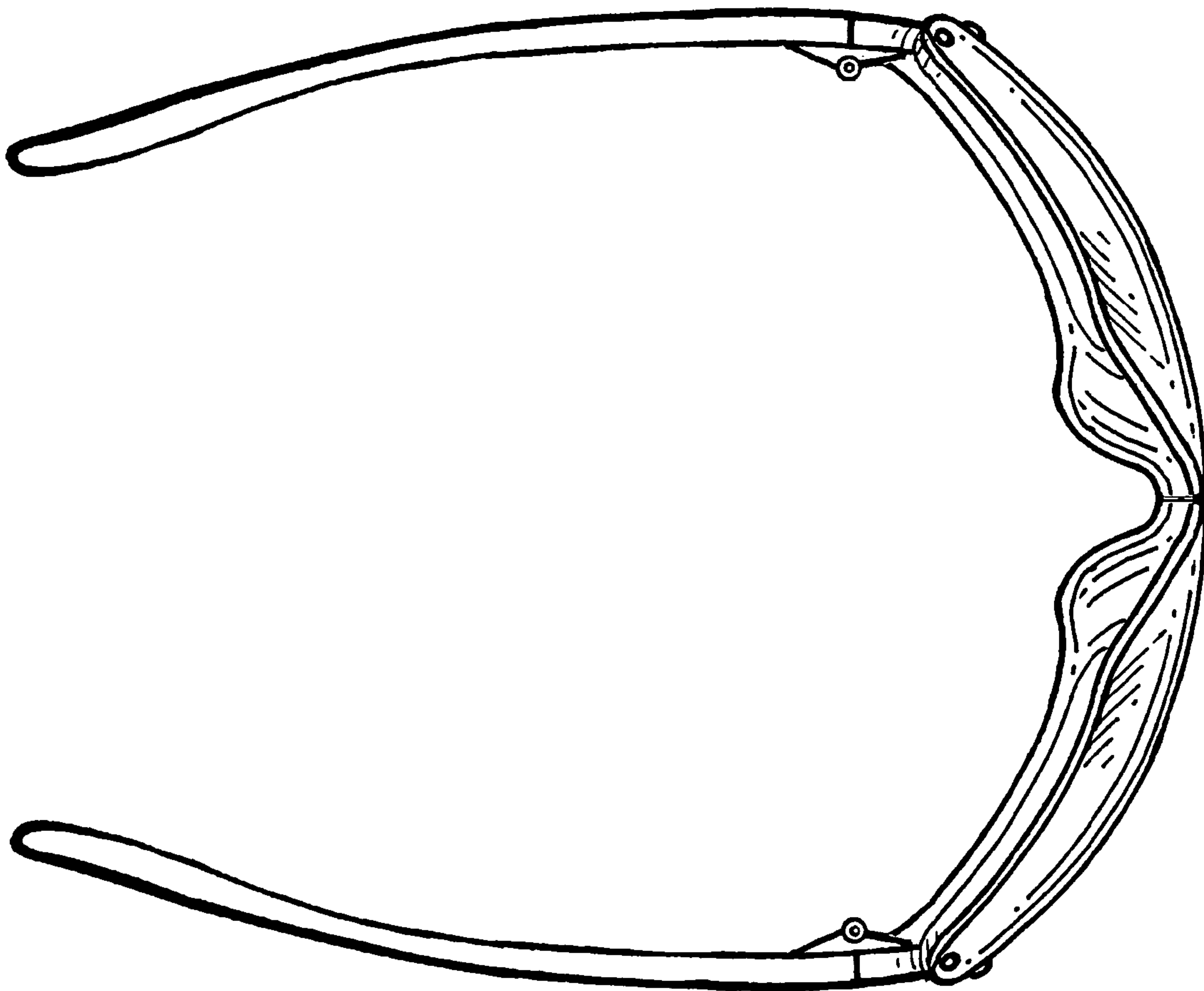

FIG. 5

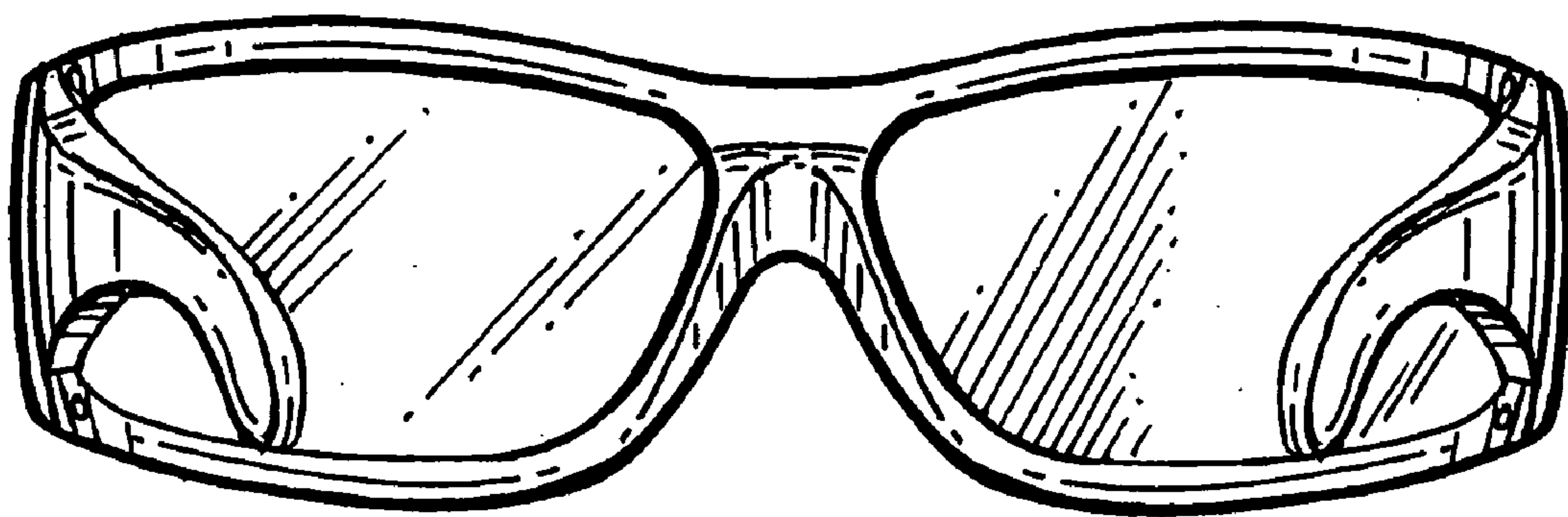

FIG.6