

US00D565040S

(12) **United States Design Patent**  
**Travis et al.**

(10) **Patent No.:** **US D565,040 S**  
(45) **Date of Patent:** **\*\* Mar. 25, 2008**

- (54) **FRONT COVER FOR A HANDSET**
- (75) Inventors: **Tom Travis**, West Hollywood, CA (US); **Wei-Jong William Sheu**, West Hills, CA (US)
- (73) Assignee: **Nokia Corporation**, Espoo (FI)
- (\*\*) Term: **14 Years**
- (21) Appl. No.: **29/279,050**
- (22) Filed: **Apr. 18, 2007**

**Related U.S. Application Data**

- (62) Division of application No. 29/241,098, filed on Oct. 24, 2005, now Pat. No. Des. 558,707.

- (51) **LOC (8) Cl.** ..... **14-03**
- (52) **U.S. Cl.** ..... **D14/248**
- (58) **Field of Classification Search** ..... D14/137-138, D14/147-148, 156, 218, 247-248, 341-347, D14/496; D16/208; D21/329, 331, 333, D21/517; 348/14.01-14.02; 361/814; 379/433.01-433.13; 455/90.3, 556.1-556.2, 455/566, 575.1, 575.3, 575.4  
See application file for complete search history.

(56) **References Cited**

**U.S. PATENT DOCUMENTS**

D339,338 S *	9/1993	Tattari et al. ....	D14/138
D388,784 S *	1/1998	Phillips et al. ....	D14/138
D459,332 S *	6/2002	Peiker .....	D14/147
D484,475 S *	12/2003	Sheu .....	D14/138
D500,992 S *	1/2005	Shen et al. ....	D14/138
D502,160 S *	2/2005	Chen et al. ....	D14/138
D515,059 S *	2/2006	Wu .....	D14/138
D515,528 S *	2/2006	Miyazawa et al. ....	D14/138
D524,274 S *	7/2006	Choi et al. ....	D14/138
D539,256 S *	3/2007	Kim et al. ....	D14/138
2004/0162118 A1 *	8/2004	Park et al. ....	455/575.1
2004/0185912 A1 *	9/2004	Mason et al. ....	455/566
2006/0111052 A1 *	5/2006	Gartrell .....	455/90.3

**FOREIGN PATENT DOCUMENTS**

WO	DM/064133	*	5/2003
WO	DM/067035	*	8/2005

WO DM/068186 \* 8/2006

**OTHER PUBLICATIONS**

Nokia N70, announced 2Q 2005, <URL:http://www.gsmarena.com/nokia\_n70-1153.php>, retrieved from internet on Sep. 2, 2007.\*  
Nokia 7360, announced Oct. 2005, <URL:http://www.gsmarena.com/nokia\_7360-1330.php>, retrieved from internet on Sep. 2, 2007.\*

\* cited by examiner

*Primary Examiner*—Ian Simmons  
*Assistant Examiner*—Carla Jobe Wright  
(74) *Attorney, Agent, or Firm*—Banner & Witcoff, Ltd.

(57) **CLAIM**

The ornamental design for a front cover for a handset, as shown and described.

**DESCRIPTION**

FIG. 1 is a bottom plan view of a front cover for a handset showing our new design in isolation;  
FIG. 2 is a right side view thereof;  
FIG. 3 is a front view thereof;  
FIG. 4 is a left side view thereof;  
FIG. 5 is a top plan view thereof;  
FIG. 6 is a front perspective view thereof;  
FIG. 7 is a bottom plan view of a front cover for a handset in the environment of a remainder of a handset;  
FIG. 8 is a right side view thereof;  
FIG. 9 is a front view thereof;  
FIG. 10 is a left side view thereof;  
FIG. 11 is a top plan view thereof;  
FIG. 12 is a rear view thereof;  
FIG. 13 is a front perspective view thereof; and,  
FIG. 14 is a rear perspective view thereof.

The broken line showing of environmental structures is for illustrative purposes only and forms no part of the claimed design.

**1 Claim, 5 Drawing Sheets**

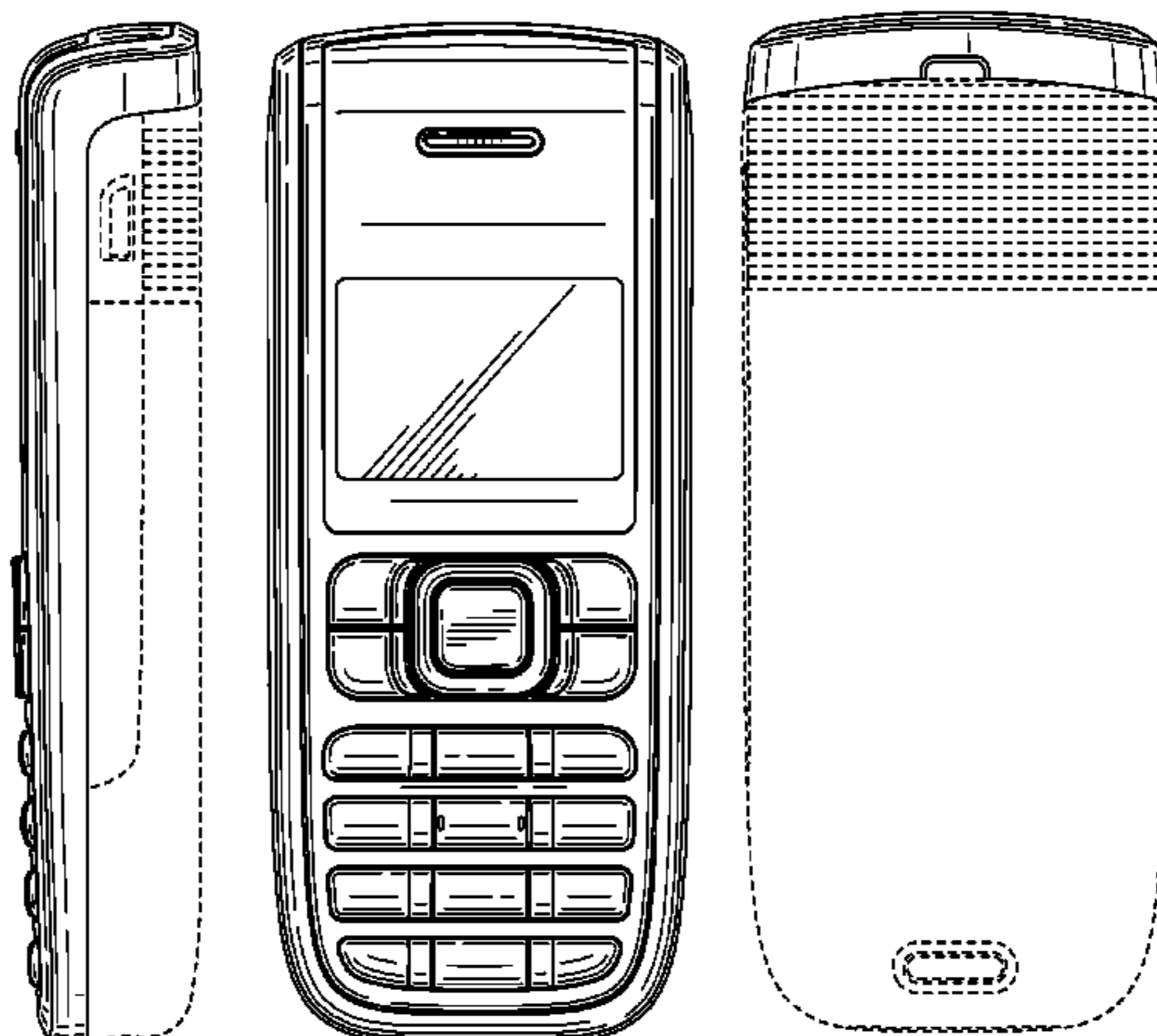

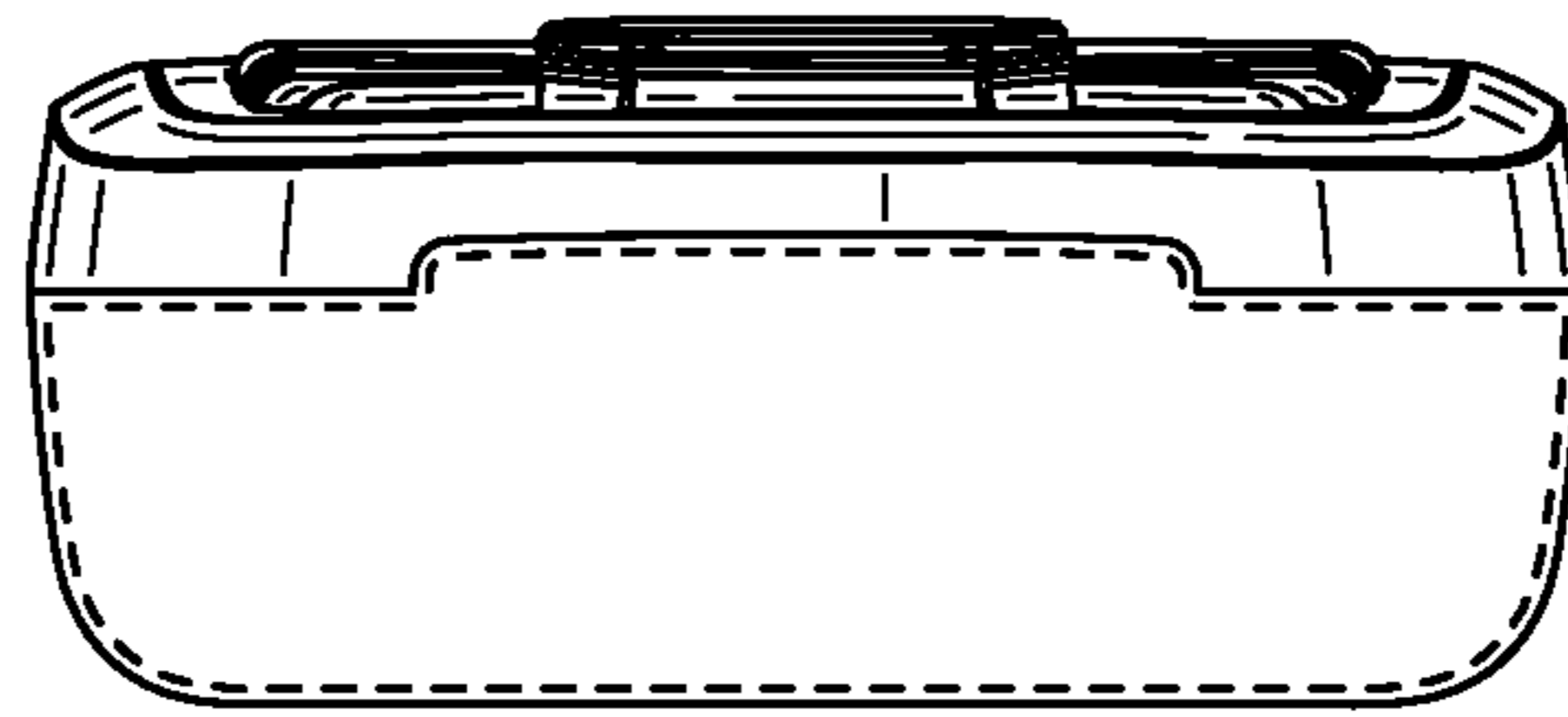

FIG. 1

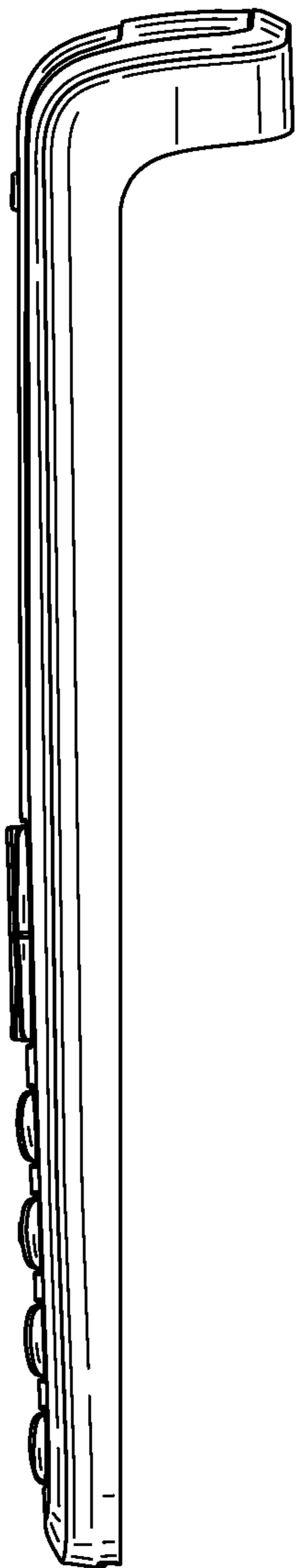

FIG. 2

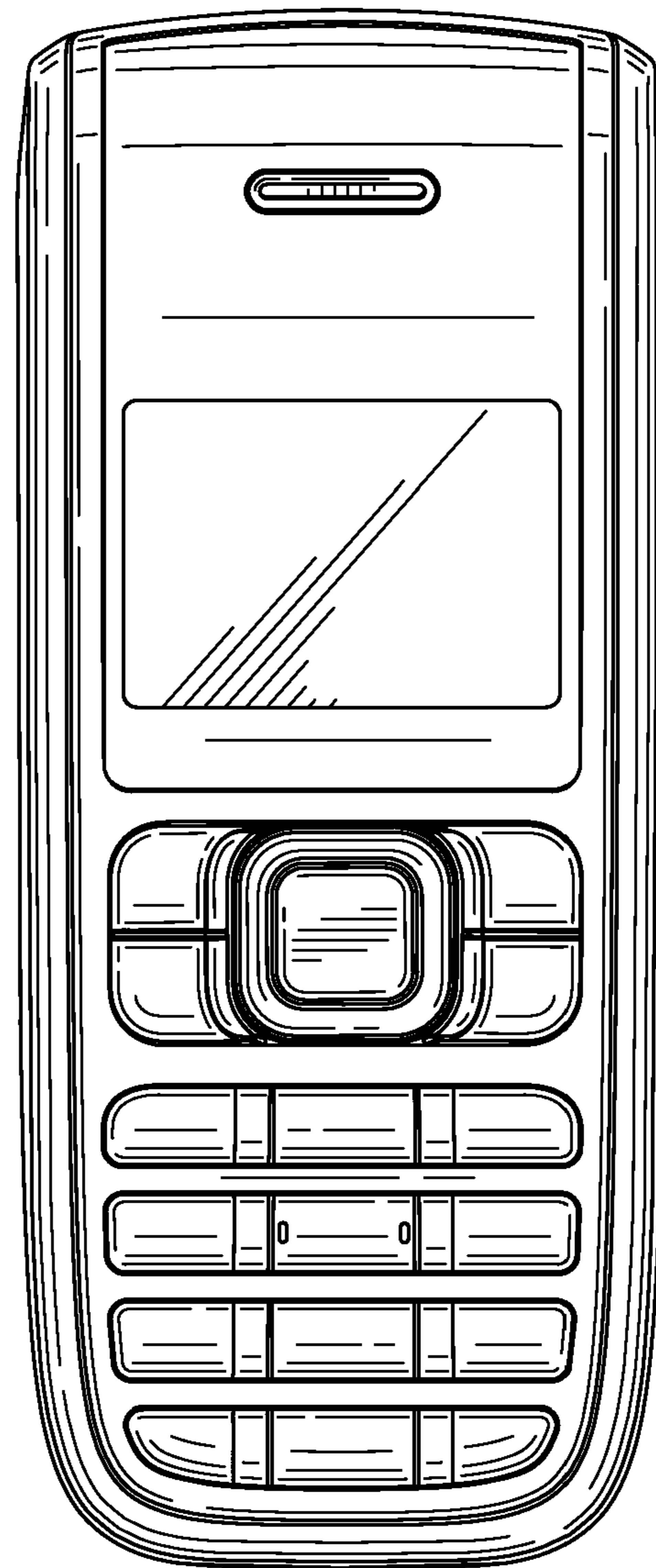

FIG. 3



FIG. 4

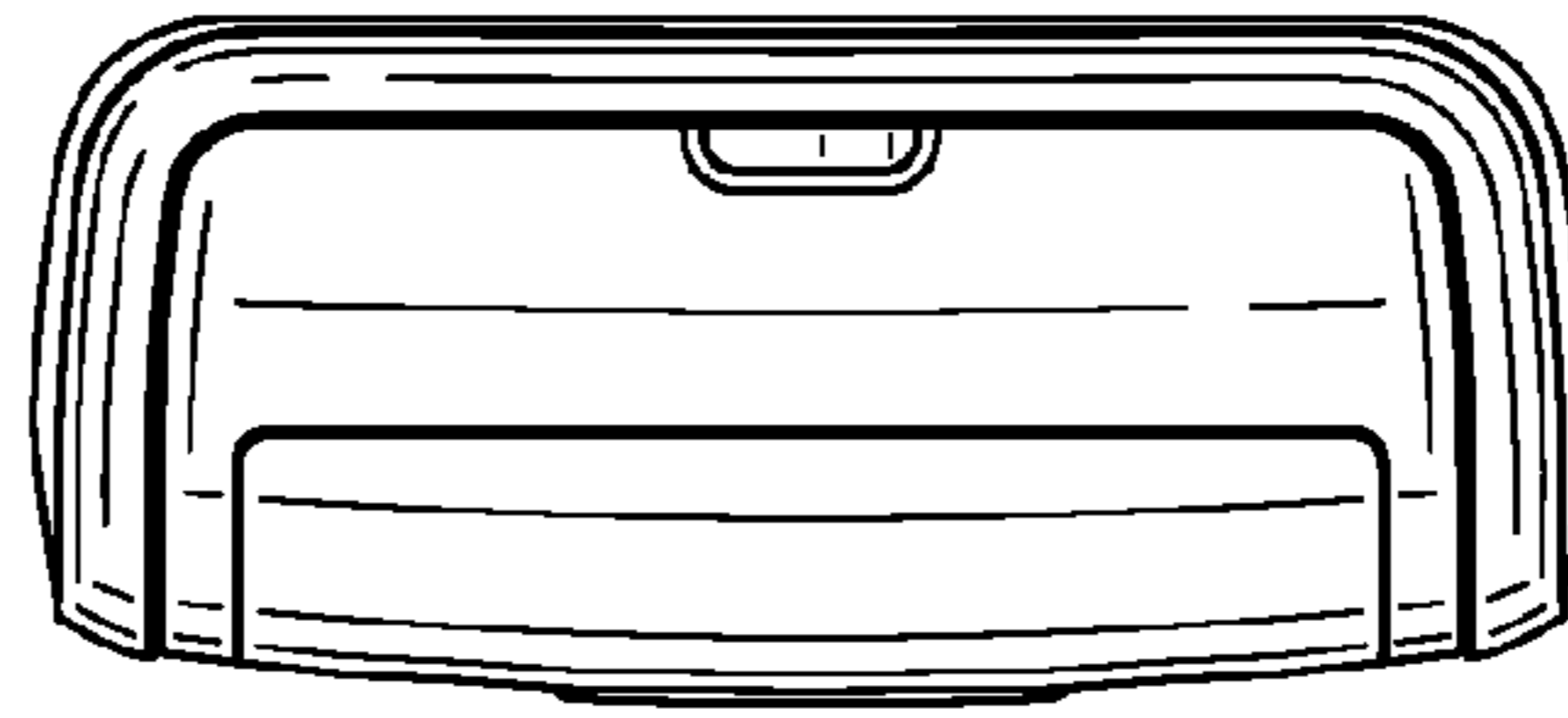

FIG. 5

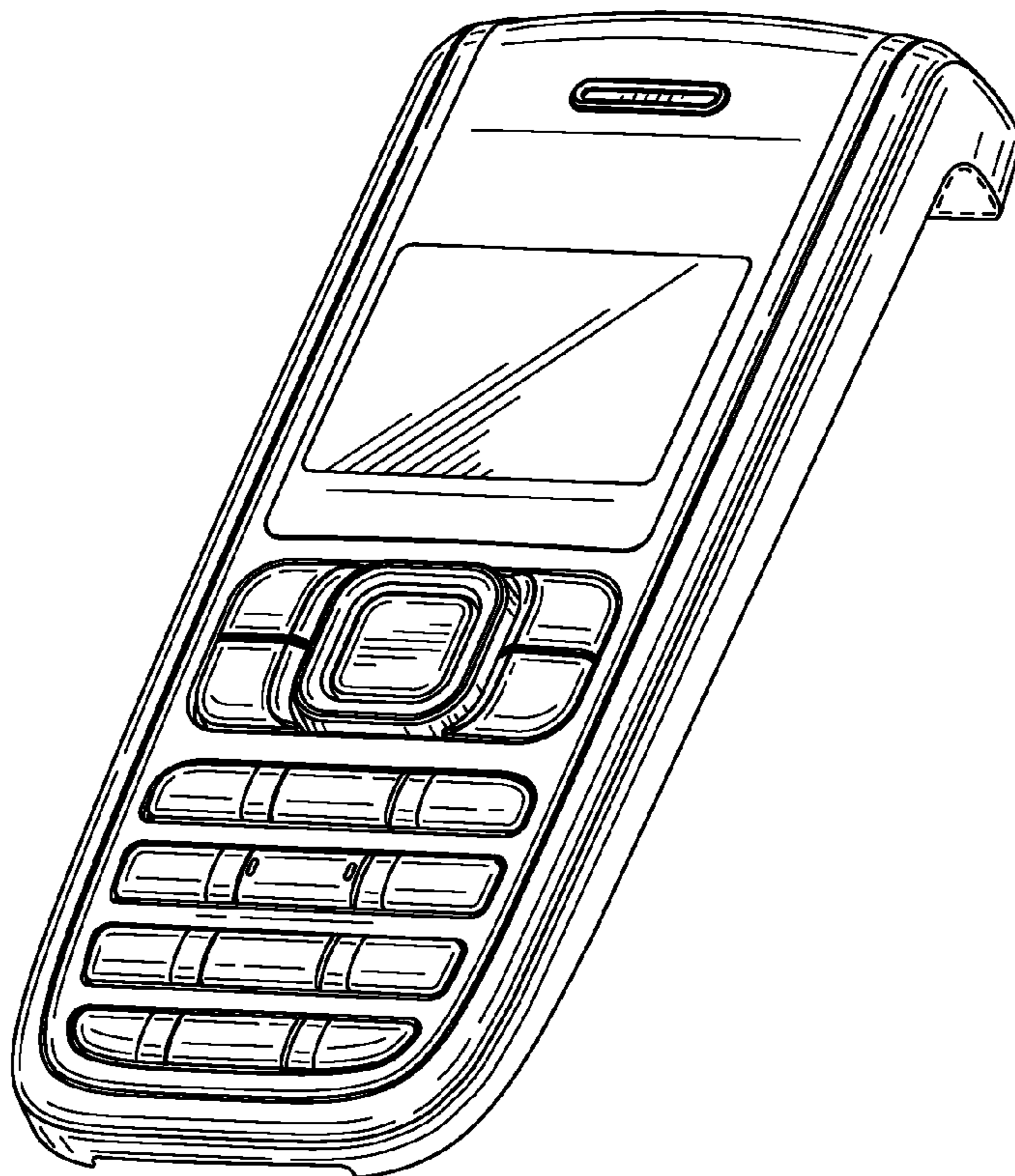

FIG. 6

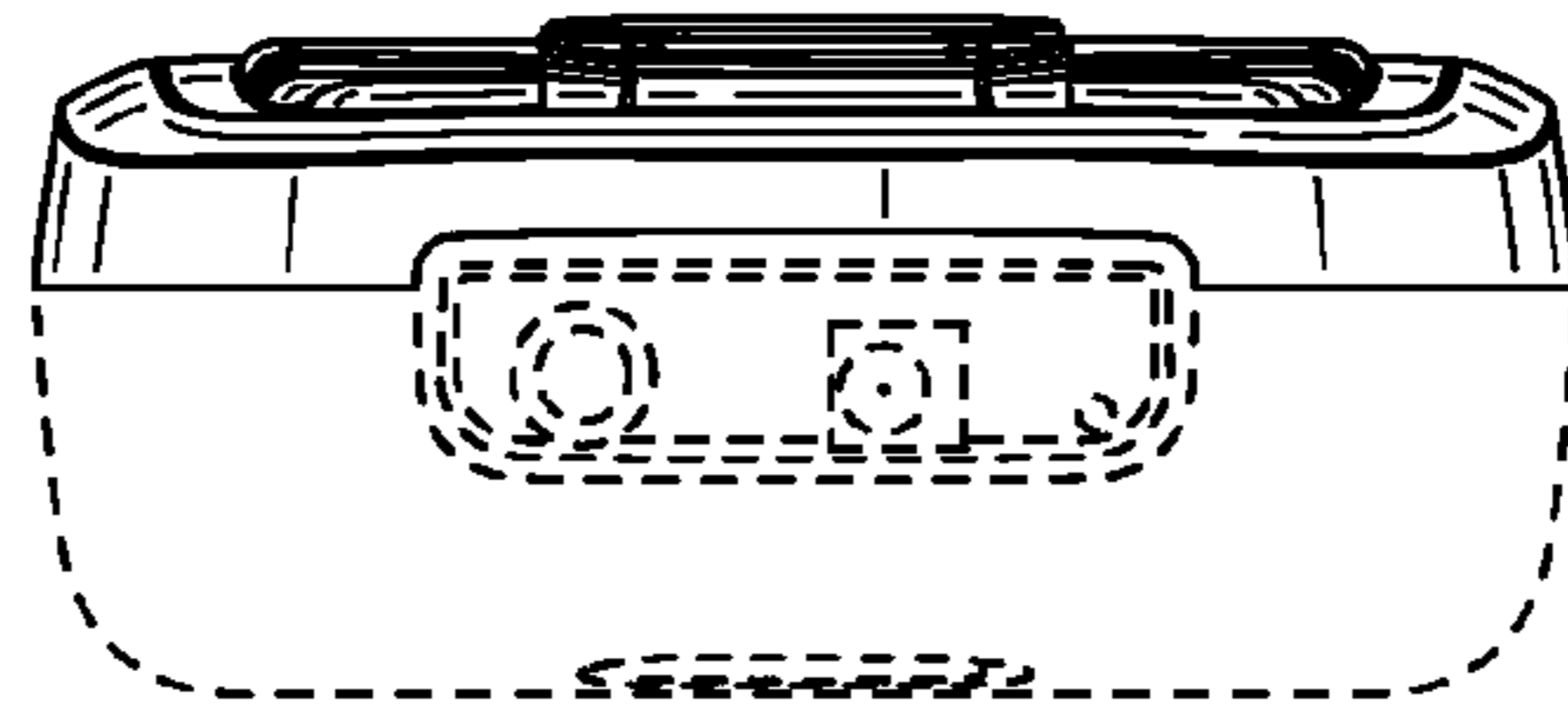

FIG. 7

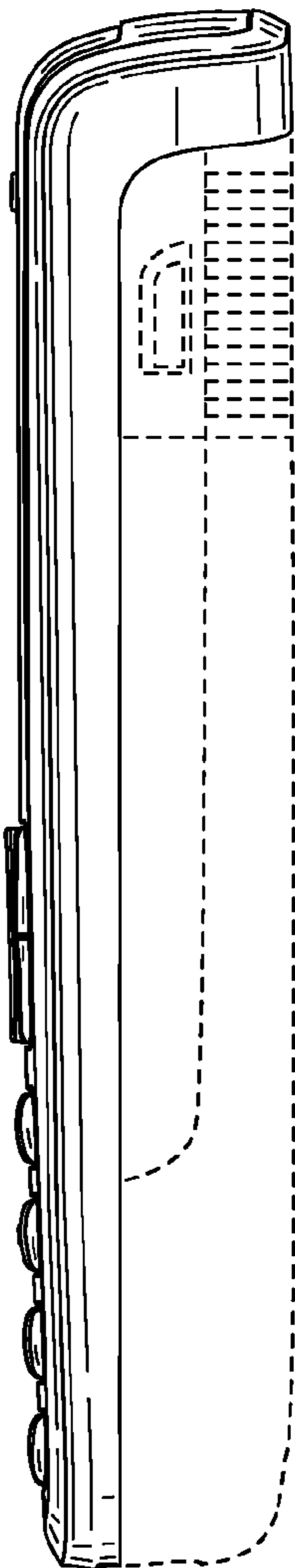

FIG. 8

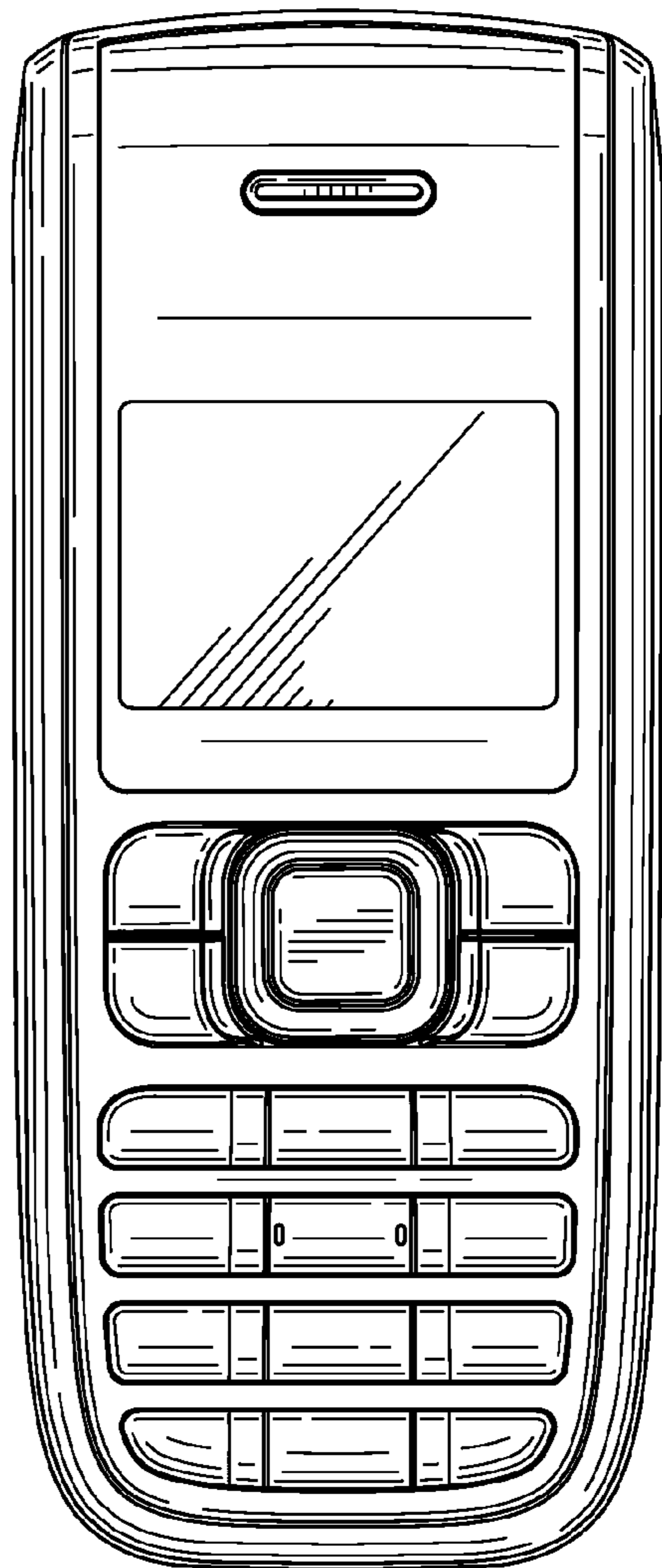

FIG. 9

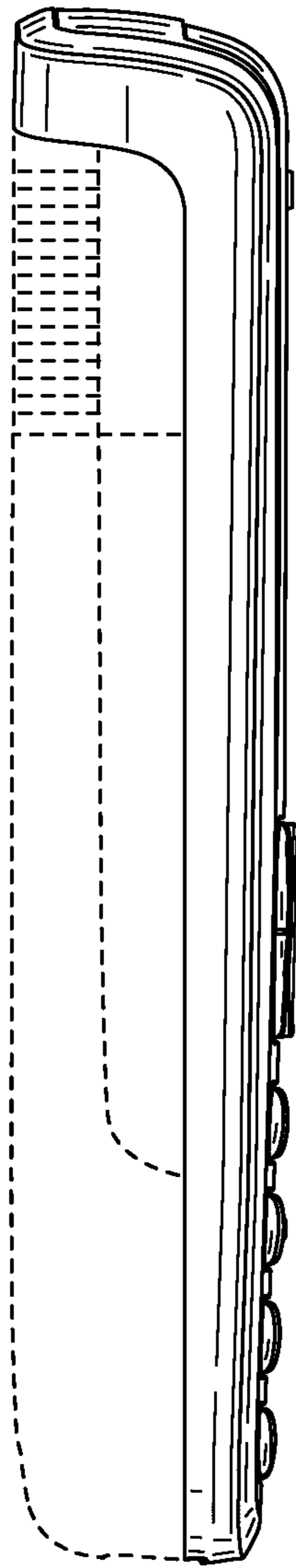

FIG. 10

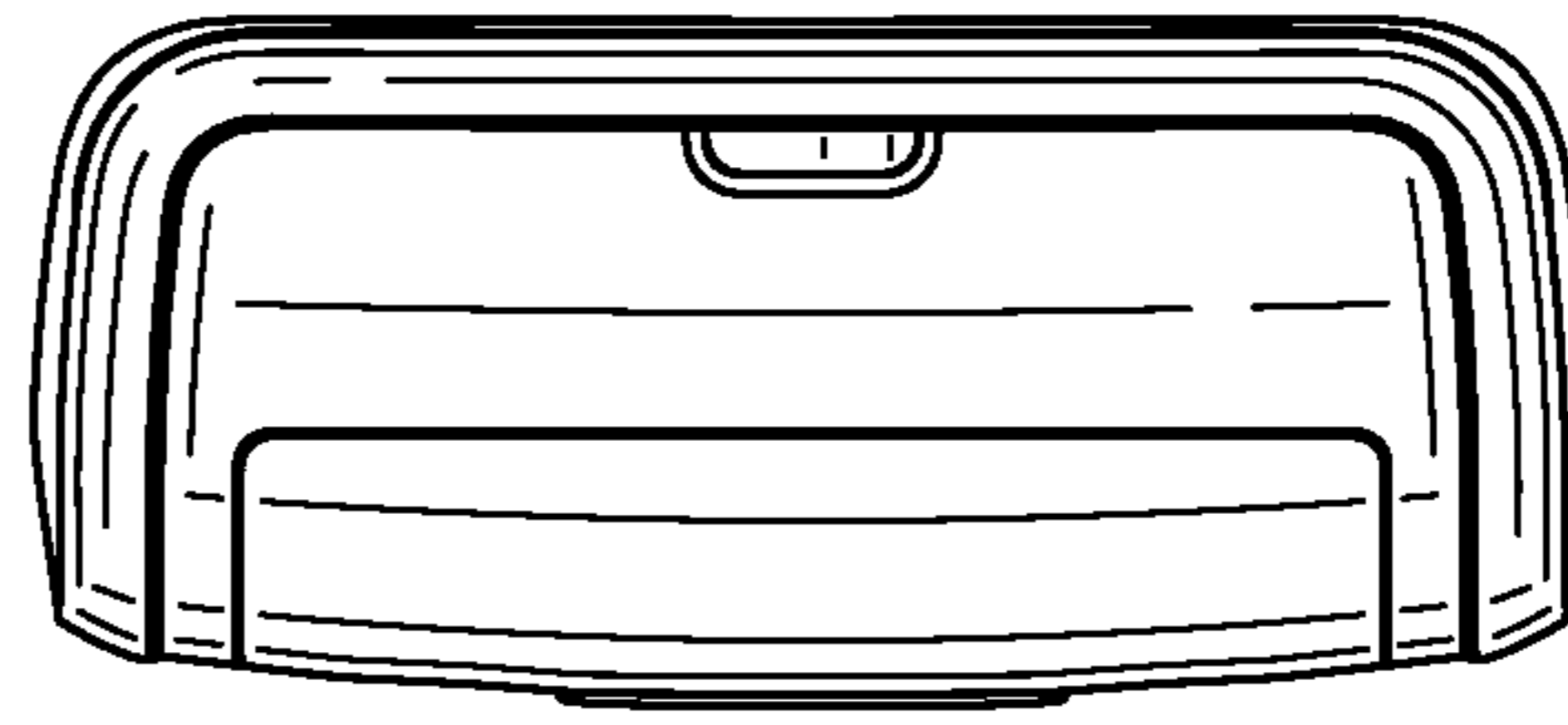

FIG. 11

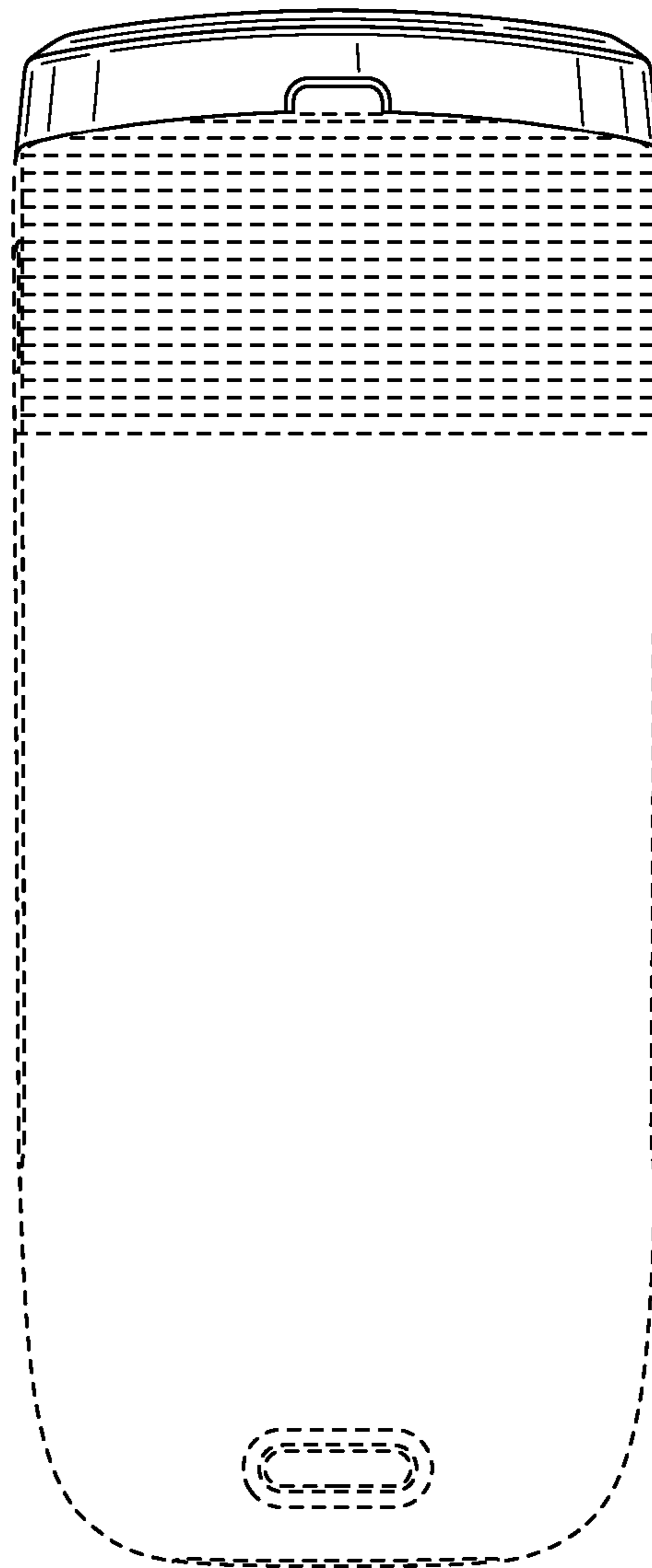

FIG. 12

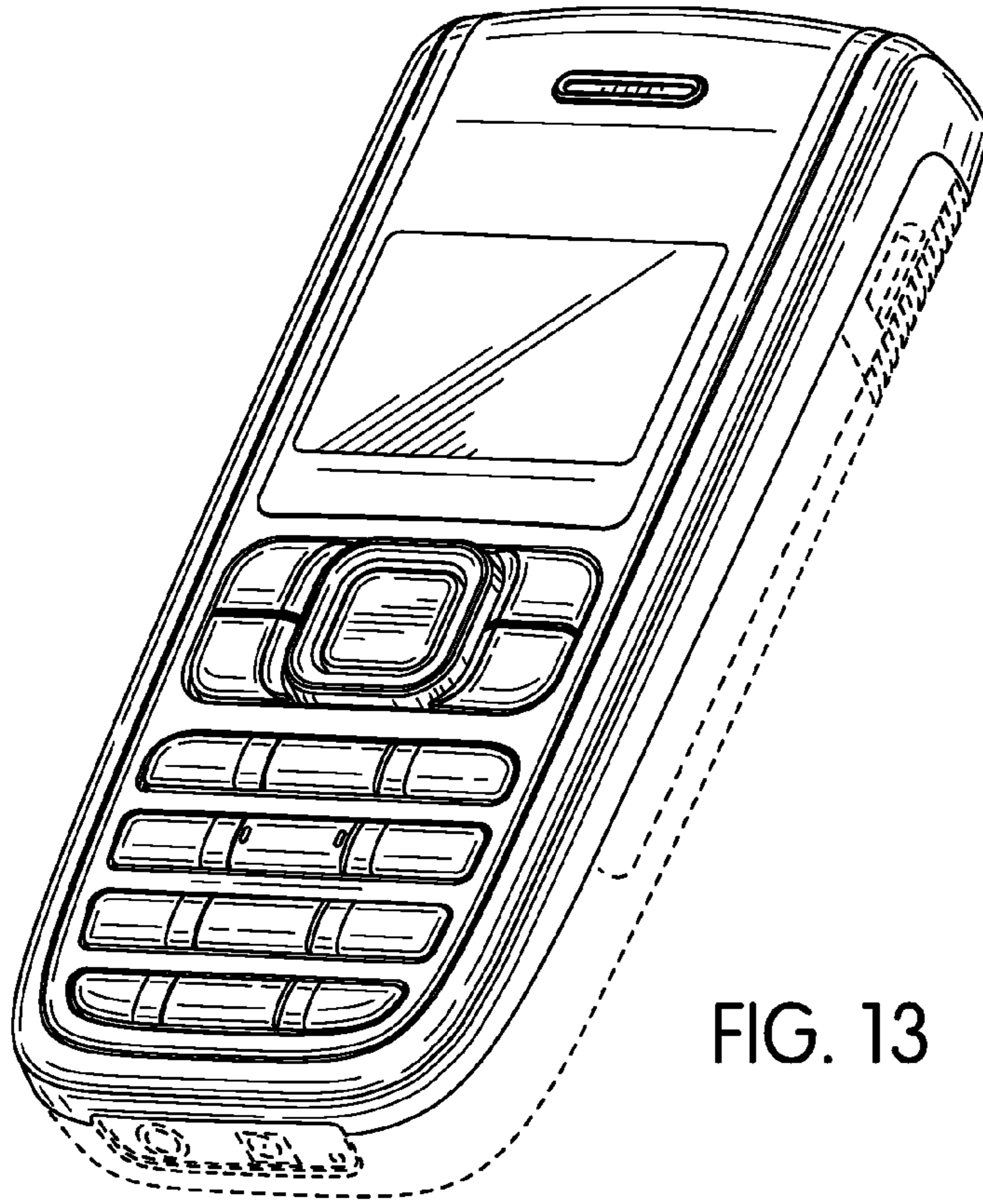

FIG. 13

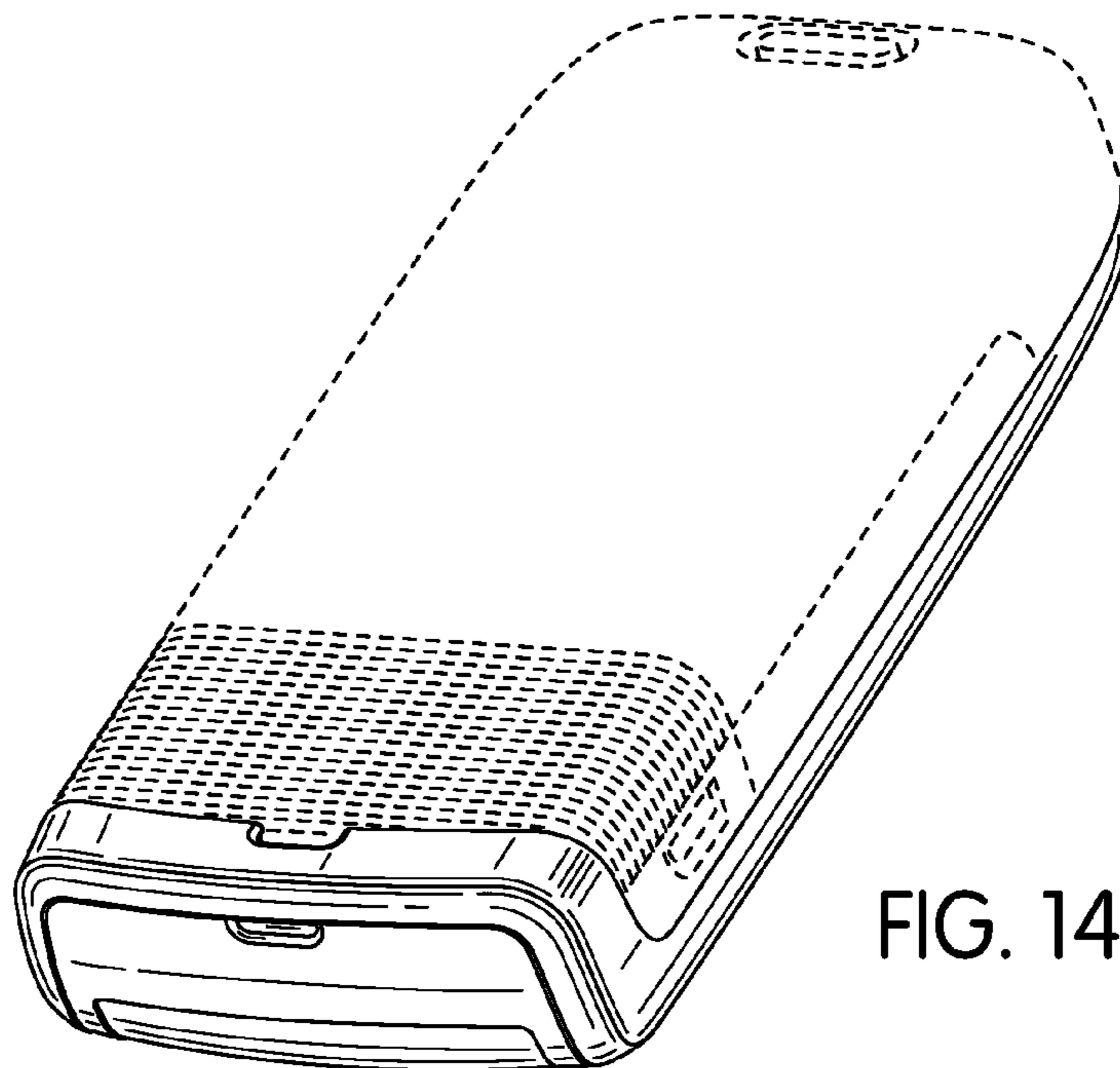

FIG. 14