

US00D565036S

(12) **United States Design Patent**
Ju et al.

(10) **Patent No.:** **US D565,036 S**
(45) **Date of Patent:** **** Mar. 25, 2008**

- (54) **WIRELESS REPEATER**
- (75) Inventors: **Tai-Hyung Ju**, Seoul (KR); **Soo-Gil Seo**, Seoul (KR)
- (73) Assignee: **Samsung Electronics Co., Ltd.**, Kyunggi-do (KR)
- (**) Term: **14 Years**
- (21) Appl. No.: **29/234,999**
- (22) Filed: **Jul. 26, 2005**
- (51) **LOC (8) Cl.** **14-03**
- (52) **U.S. Cl.** **D14/240**
- (58) **Field of Classification Search** D14/125, D14/137, 140, 188, 240, 242, 251, 356, 358; D10/104, 106; D13/120, 123, 137.1, 138.1; 379/338-349, 387.01, 399.01, 413.02, 413.04; 455/524, 569.1, 7-25; 439/692; 307/156
See application file for complete search history.

- D528,544 S * 9/2006 Kim D14/356
- D529,904 S * 10/2006 Yeo D14/240
- D532,780 S * 11/2006 Proctor et al. D14/240
- D533,518 S * 12/2006 Hsiung D14/125

OTHER PUBLICATIONS

MCX-600 Visonic Wireless repeater for PowerCode system, <URL:http://images.google.com>, retrieved from internet Nov. 9, 2007.*

* cited by examiner

Primary Examiner—Ian Simmons

Assistant Examiner—Carla Jobe Wright

(74) *Attorney, Agent, or Firm*—Flynn, Thiel, Boutell & Tanis, P.C.

(56) **References Cited**

U.S. PATENT DOCUMENTS

- 3,034,000 A * 5/1962 Todd 307/156
- D314,177 S * 1/1991 Heiligenstein et al. .. D13/138.1
- 5,083,946 A * 1/1992 Chester, Jr. 439/692
- D333,122 S * 2/1993 Kamakura et al. D13/123
- D357,234 S * 4/1995 Yoshihara D14/358
- D374,657 S * 10/1996 Beranek D13/138.1
- D375,950 S * 11/1996 Jones et al. D14/137
- D433,642 S * 11/2000 Bauman D10/104
- D471,543 S * 3/2003 Yang et al. D14/240

(57) **CLAIM**

The ornamental design for a wireless repeater, as shown and described.

DESCRIPTION

FIG. 1. is a top front perspective view of a wireless repeater showing our new design.

FIG. 2. is a front elevational view thereof.

FIG. 3. is a rear elevational view thereof.

FIG. 4. is a left side elevational view thereof.

FIG. 5. is a right side elevational view thereof.

FIG. 6. is a top plan view thereof; and,

FIG. 7. is a bottom plan view thereof.

1 Claim, 4 Drawing Sheets

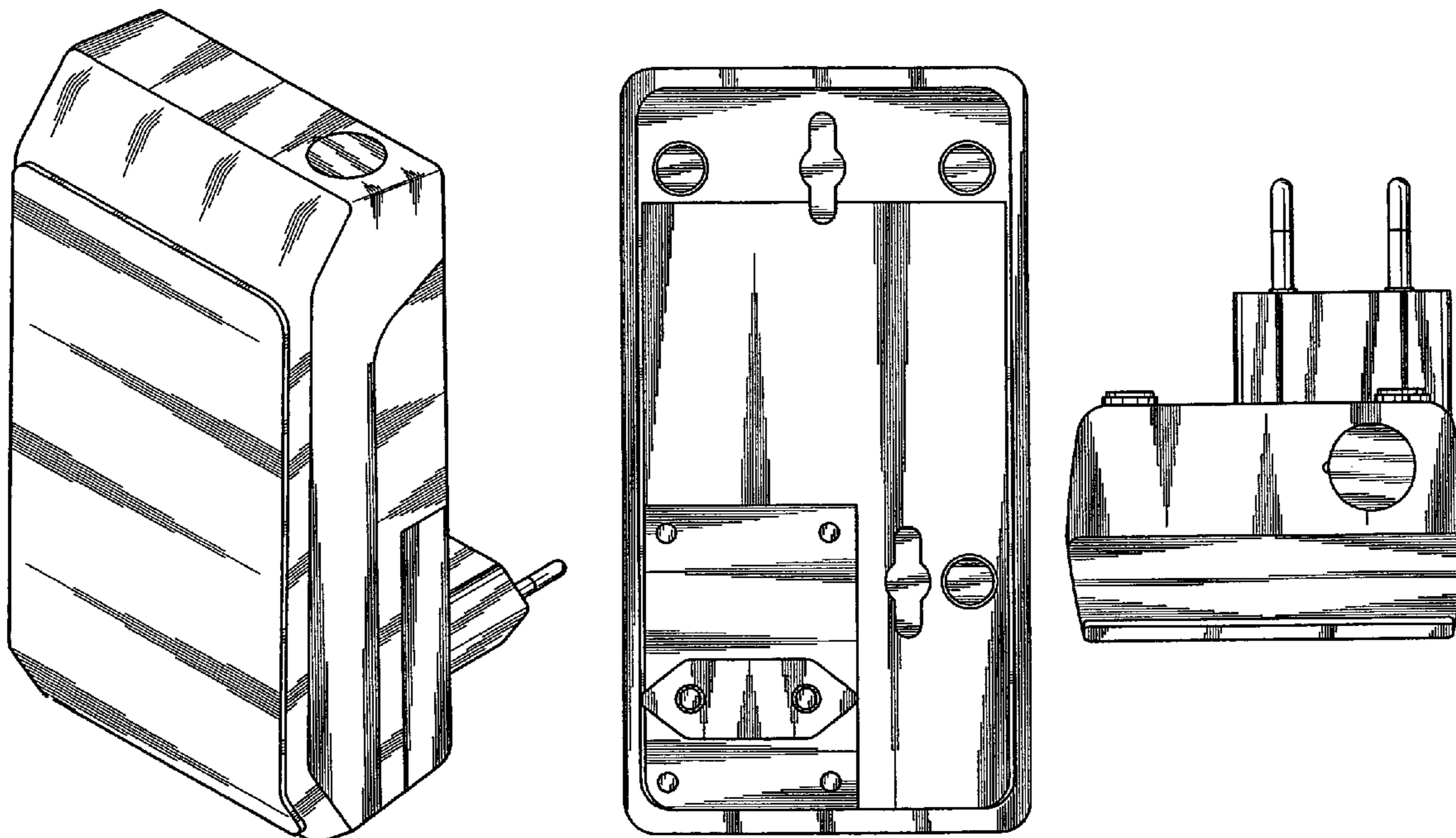

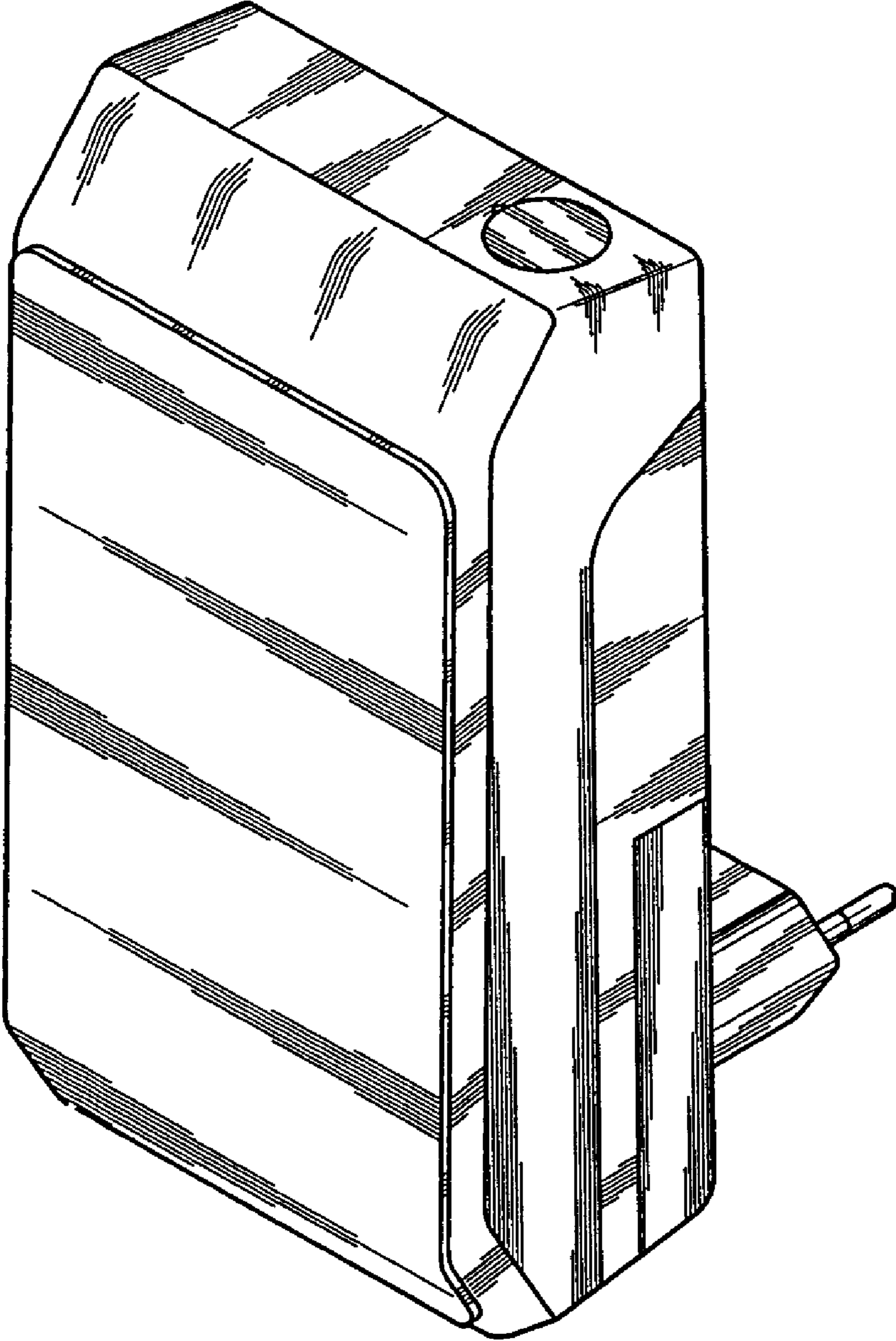

FIG. 1

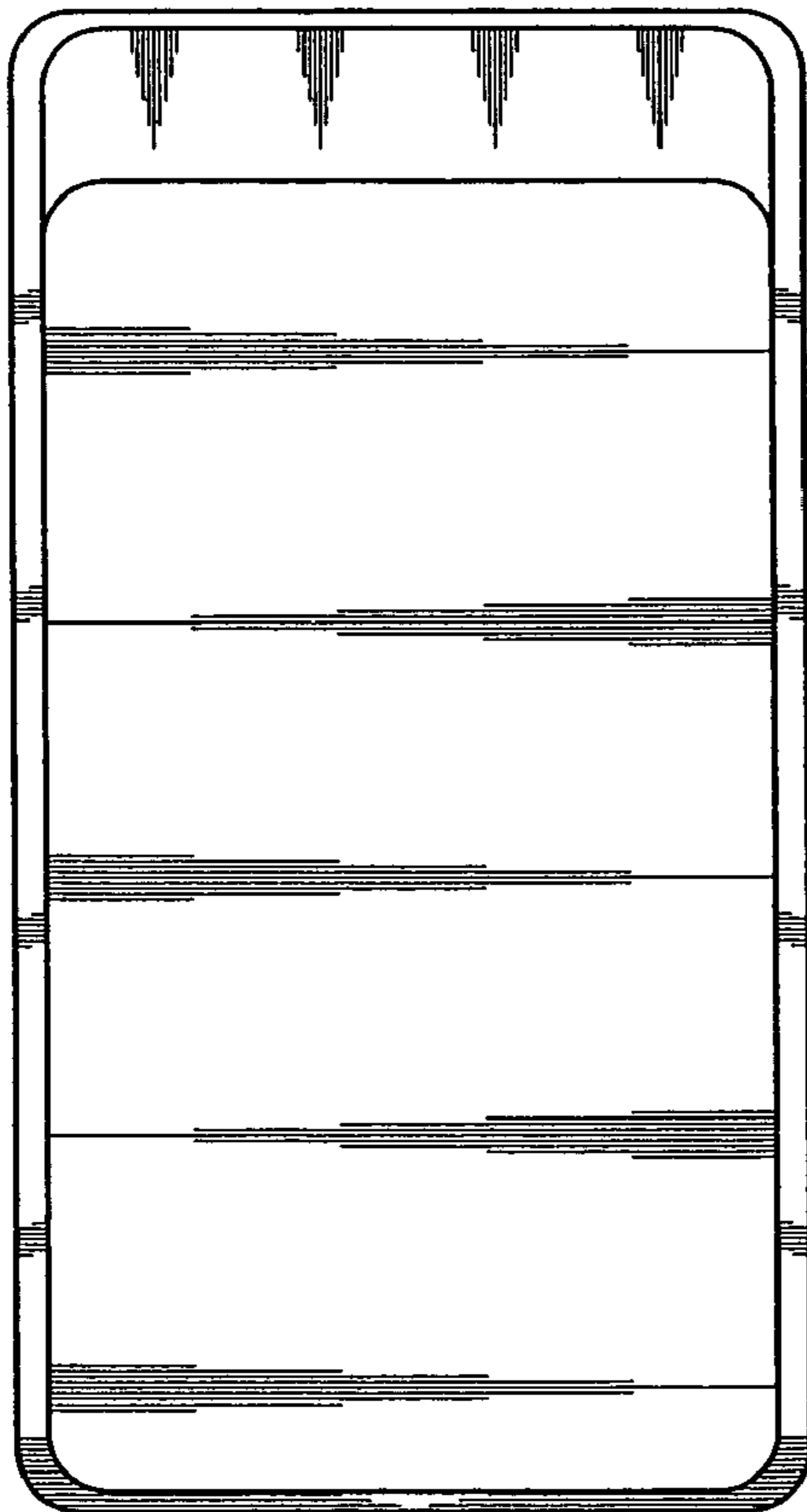

FIG. 2

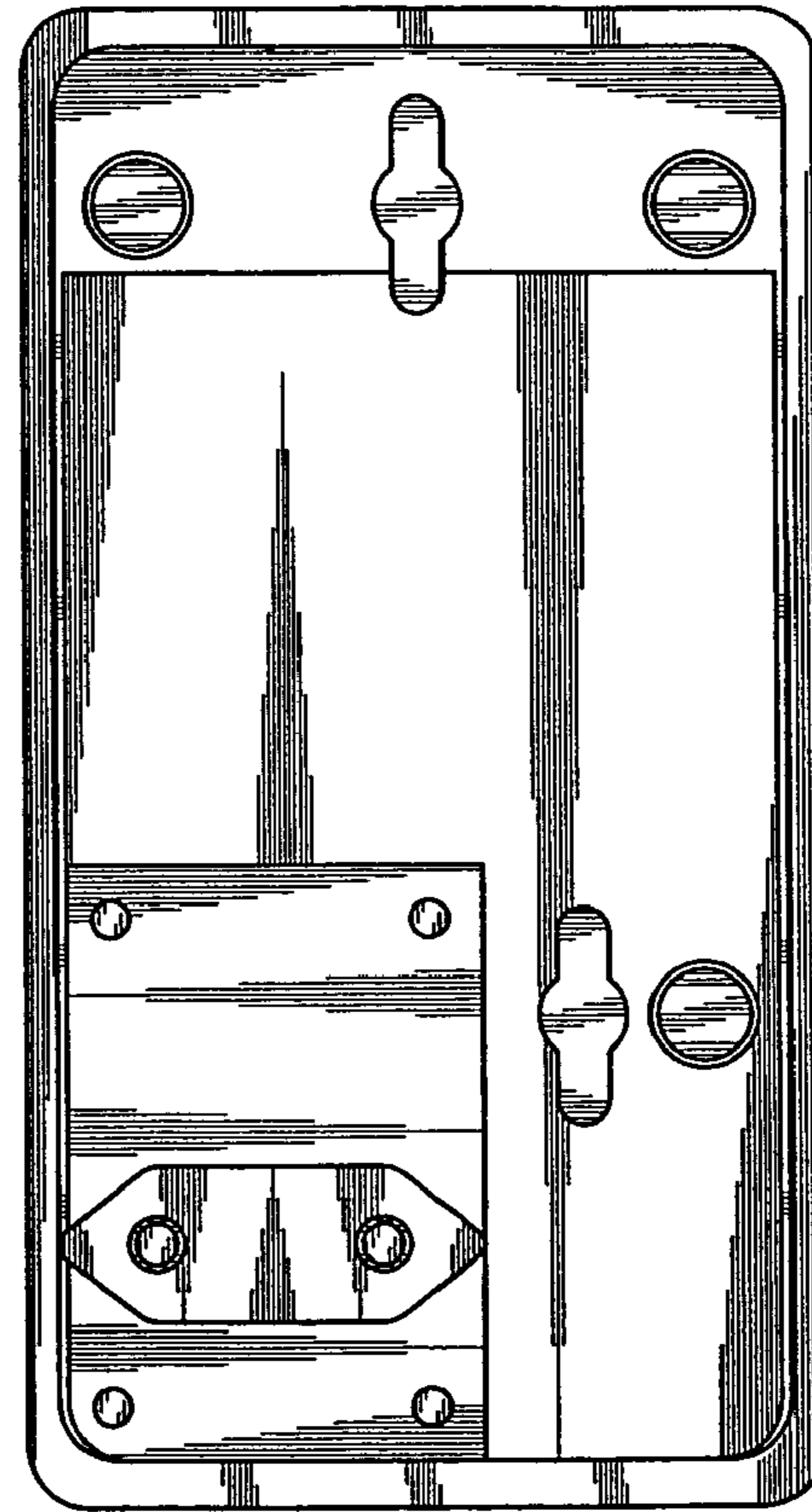

FIG. 3

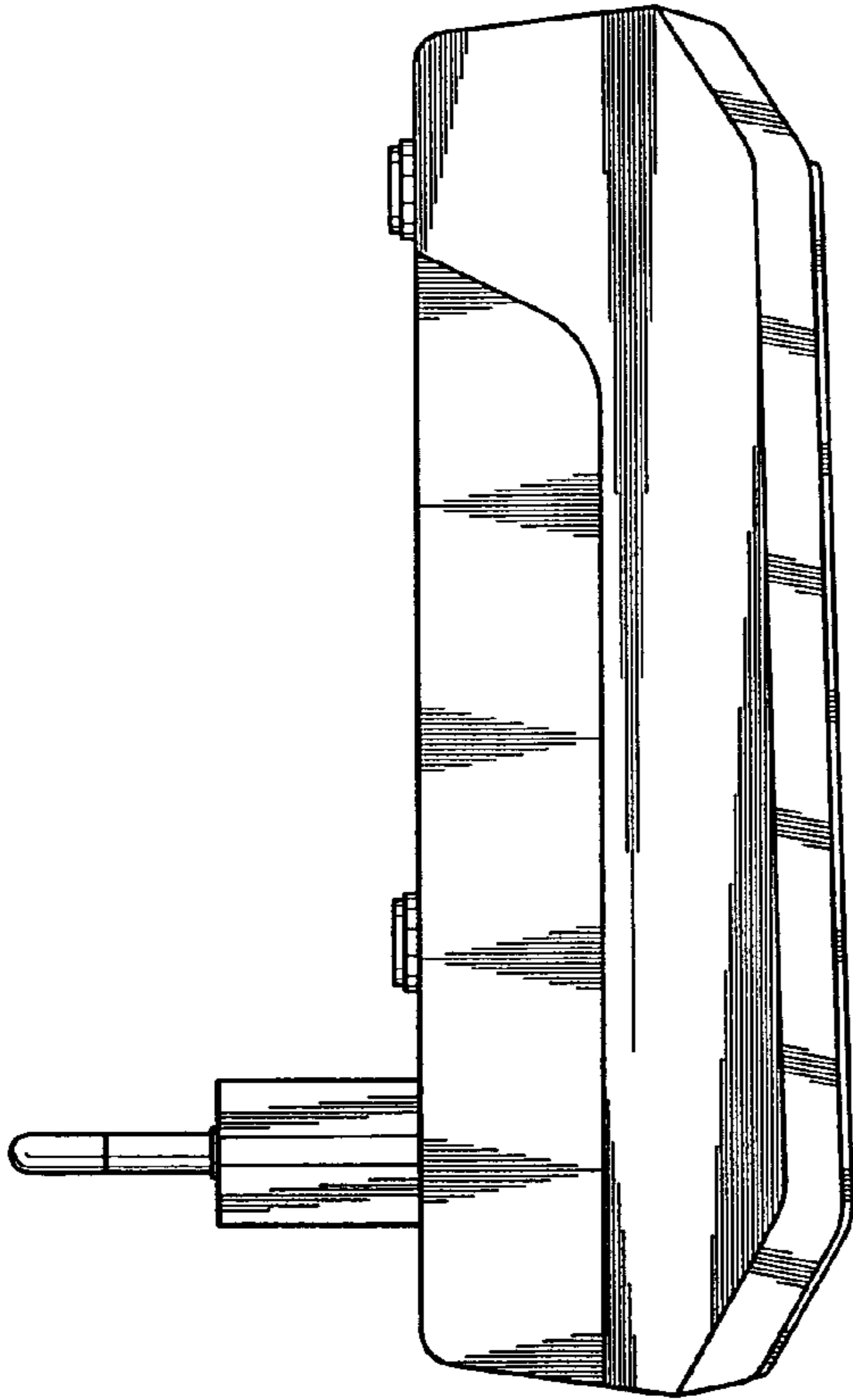

FIG. 4

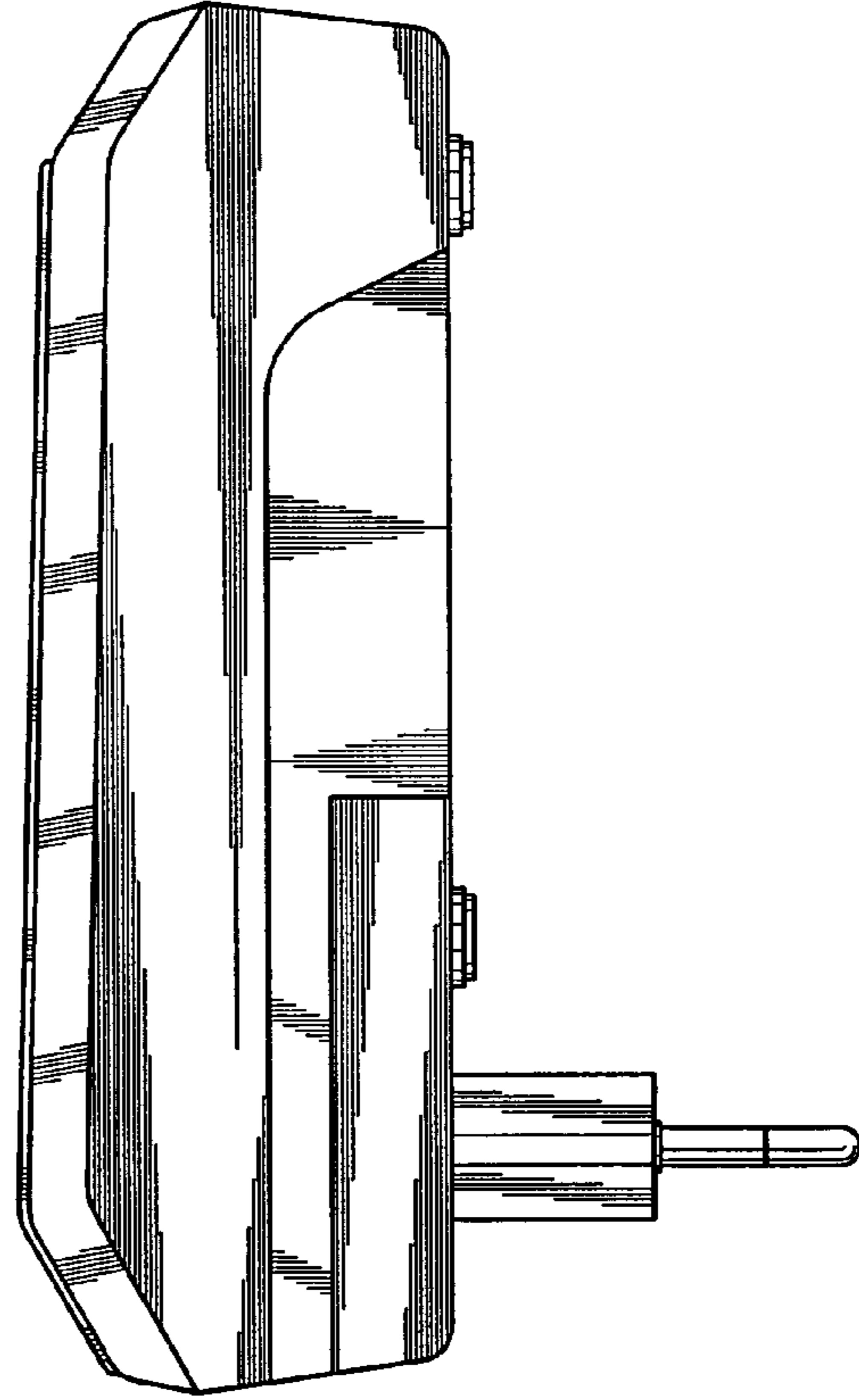

FIG. 5

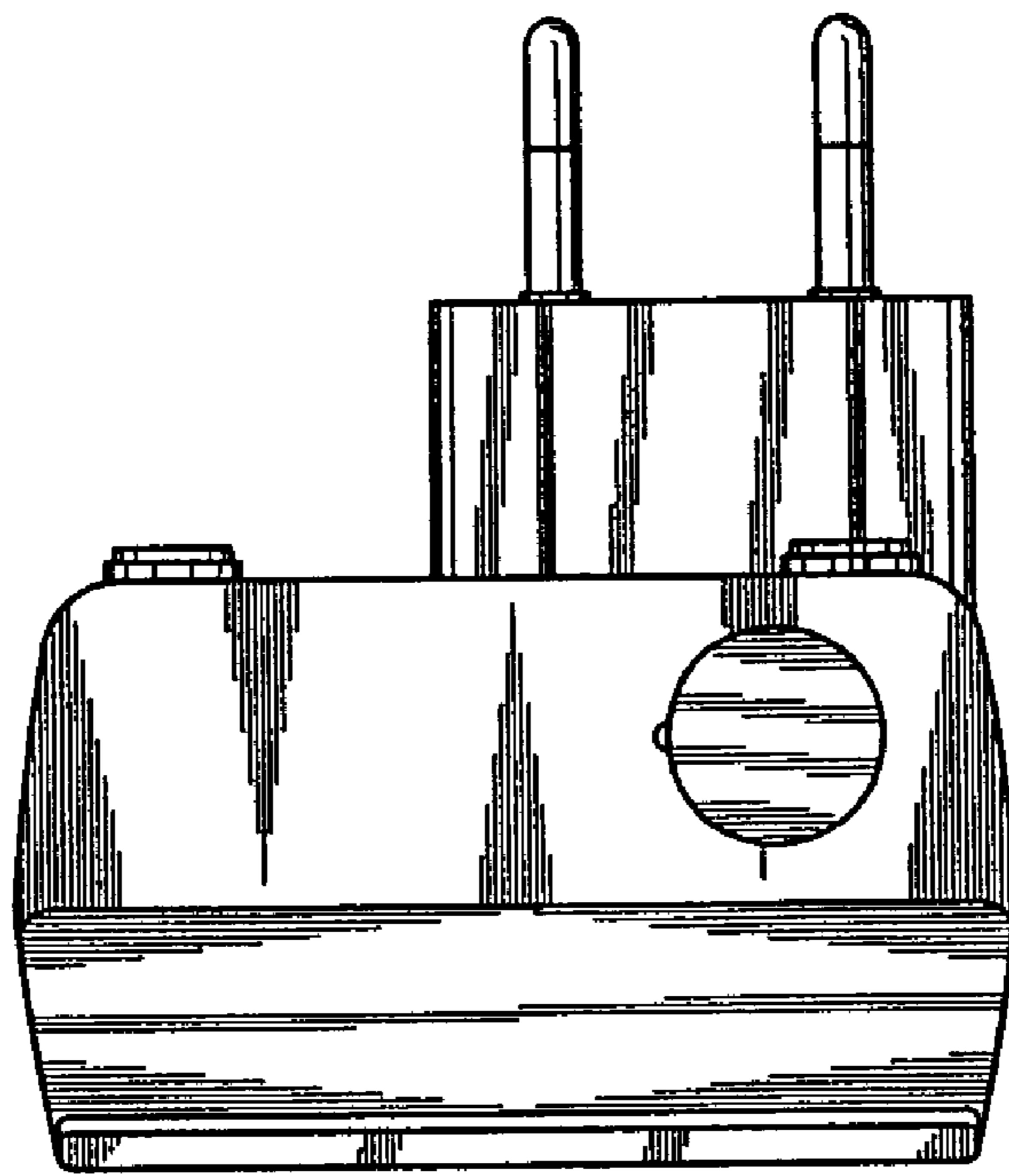

FIG. 6

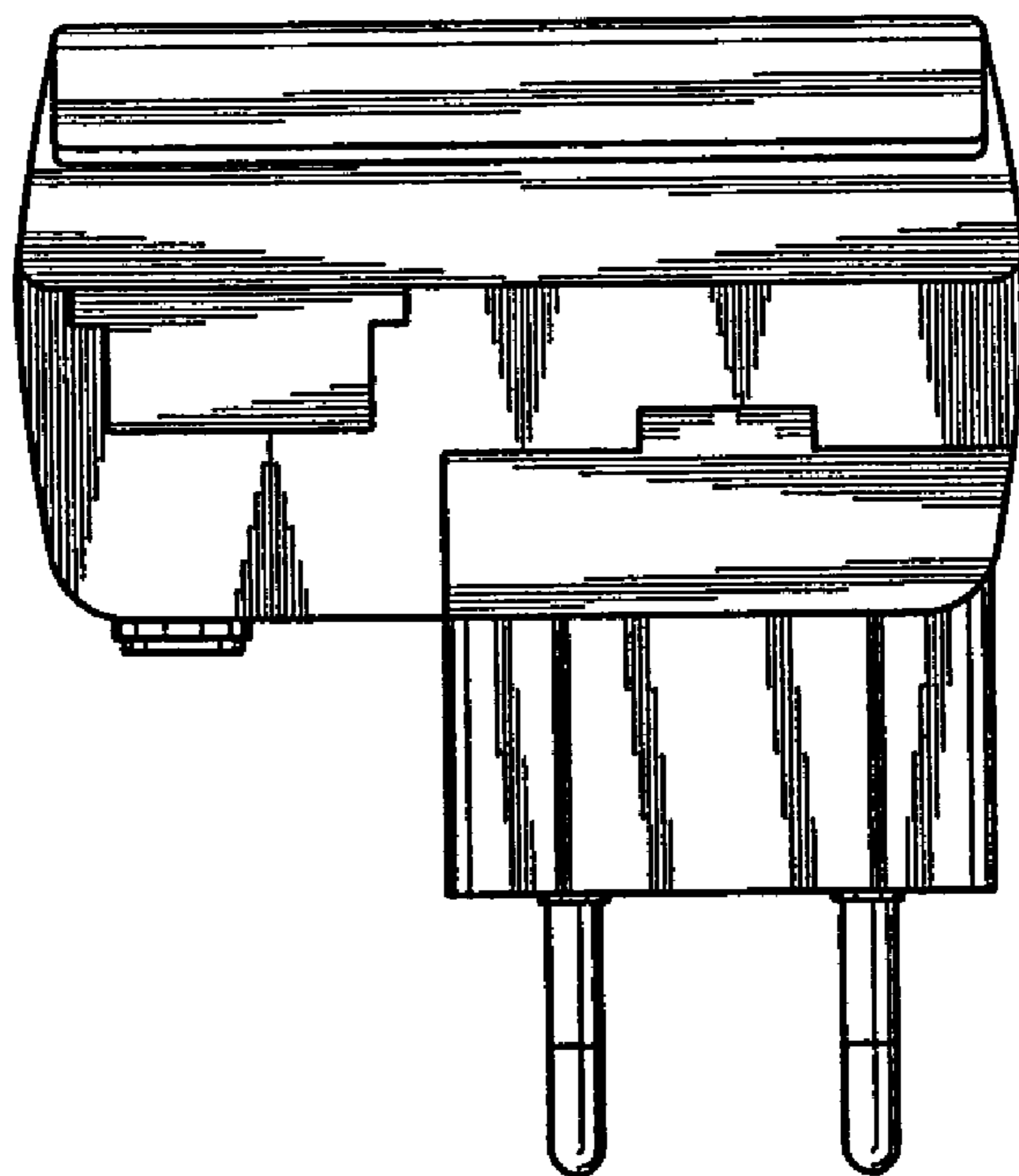

FIG. 7