

US00D565012S

(12) **United States Design Patent**  
**Lee et al.**

(10) **Patent No.:** **US D565,012 S**  
(45) **Date of Patent:** **\*\* Mar. 25, 2008**

(54) **MOBILE PHONE**

(75) Inventors: **Hye-Jeong Lee**, Seoul (KR); **Bum-Soo Park**, Gwangmyeong-si (KR); **Nam-Mi Kim**, Seoul (KR); **Chang-Hwan Hwang**, Goyang-si (KR)

(73) Assignee: **Samsung Electronics Co., Ltd.**, Suwon-Si (KR)

(\*\*) Term: **14 Years**

(21) Appl. No.: **29/260,500**

(22) Filed: **May 26, 2006**

(30) **Foreign Application Priority Data**

Jan. 24, 2006 (KR) ..... 30-2006-0002829

(51) **LOC (8) Cl.** ..... **14-03**

(52) **U.S. Cl.** ..... **D14/138**

(58) **Field of Classification Search** ..... D14/496,  
D14/138, 341-347; 455/575.3, 575.1; D21/517,  
D21/329, 333

See application file for complete search history.

(56) **References Cited**

**U.S. PATENT DOCUMENTS**

D485,818 S *	1/2004	Yabe et al.	.....	D14/138
D500,016 S *	12/2004	Kim	.....	D14/138
D501,839 S *	2/2005	Lee et al.	.....	D14/138
D502,458 S *	3/2005	Chung et al.	.....	D14/138
D510,078 S *	9/2005	Lee et al.	.....	D14/138
D512,039 S *	11/2005	Kim et al.	.....	D14/138
D512,394 S *	12/2005	Kim et al.	.....	D14/138
D518,014 S *	3/2006	Cho	.....	D14/138
D519,486 S *	4/2006	Lee et al.	.....	D14/138
D520,486 S *	5/2006	Kim et al.	.....	D14/138
D520,978 S *	5/2006	Lee	.....	D14/138
D520,981 S *	5/2006	Lee et al.	.....	D14/138
D522,991 S *	6/2006	Yun et al.	.....	D14/138
D523,411 S *	6/2006	Kim et al.	.....	D14/138
D535,962 S *	1/2007	Yun et al.	.....	D14/138
D535,963 S *	1/2007	Koh et al.	.....	D14/138
D535,965 S *	1/2007	Baik et al.	.....	D14/138

D536,321 S *	2/2007	Kim et al.	.....	D14/138
D536,322 S *	2/2007	Kim et al.	.....	D14/138
D537,429 S *	2/2007	Fahlgren	.....	D14/138
D545,288 S *	6/2007	Chung et al.	.....	D14/138
D546,305 S *	7/2007	Oh et al.	.....	D14/138
D546,796 S *	7/2007	Ahn et al.	.....	D14/138
D547,742 S *	7/2007	Lee	.....	D14/138
D550,183 S *	9/2007	Lee et al.	.....	D14/138
D552,577 S *	10/2007	Kim et al.	.....	D14/138

**FOREIGN PATENT DOCUMENTS**

JP D1188710 \* 10/2003

**OTHER PUBLICATIONS**

Samsung ZV30 telephone, announced 4th quarter—2005, [online], [site visited Oct. 25, 2007]. Available from Internet ,<URL: http://www.gsmarena.com>.\*

Samsung X670 telephone, announced 1st quarter—2006, [online], [site visited Oct. 25, 2007]. Available from Internet ,<URL: http://www.gsmarena.com>.\*

\* cited by examiner

*Primary Examiner*—Jeffrey Asch

(74) *Attorney, Agent, or Firm*—Staas & Halsey LLP

(57) **CLAIM**

The ornamental design for the mobile phone, as shown and described.

**DESCRIPTION**

FIG. 1 is a perspective view of the mobile phone showing our design;

FIG. 2 is a front view thereof;

FIG. 3 is a rear view thereof;

FIG. 4 is a left side view thereof;

FIG. 5 is a right side view thereof;

FIG. 6 is a top plan view thereof;

FIG. 7 is a bottom plan view thereof; and,

FIG. 8 is a left side open view thereof.

**1 Claim, 5 Drawing Sheets**

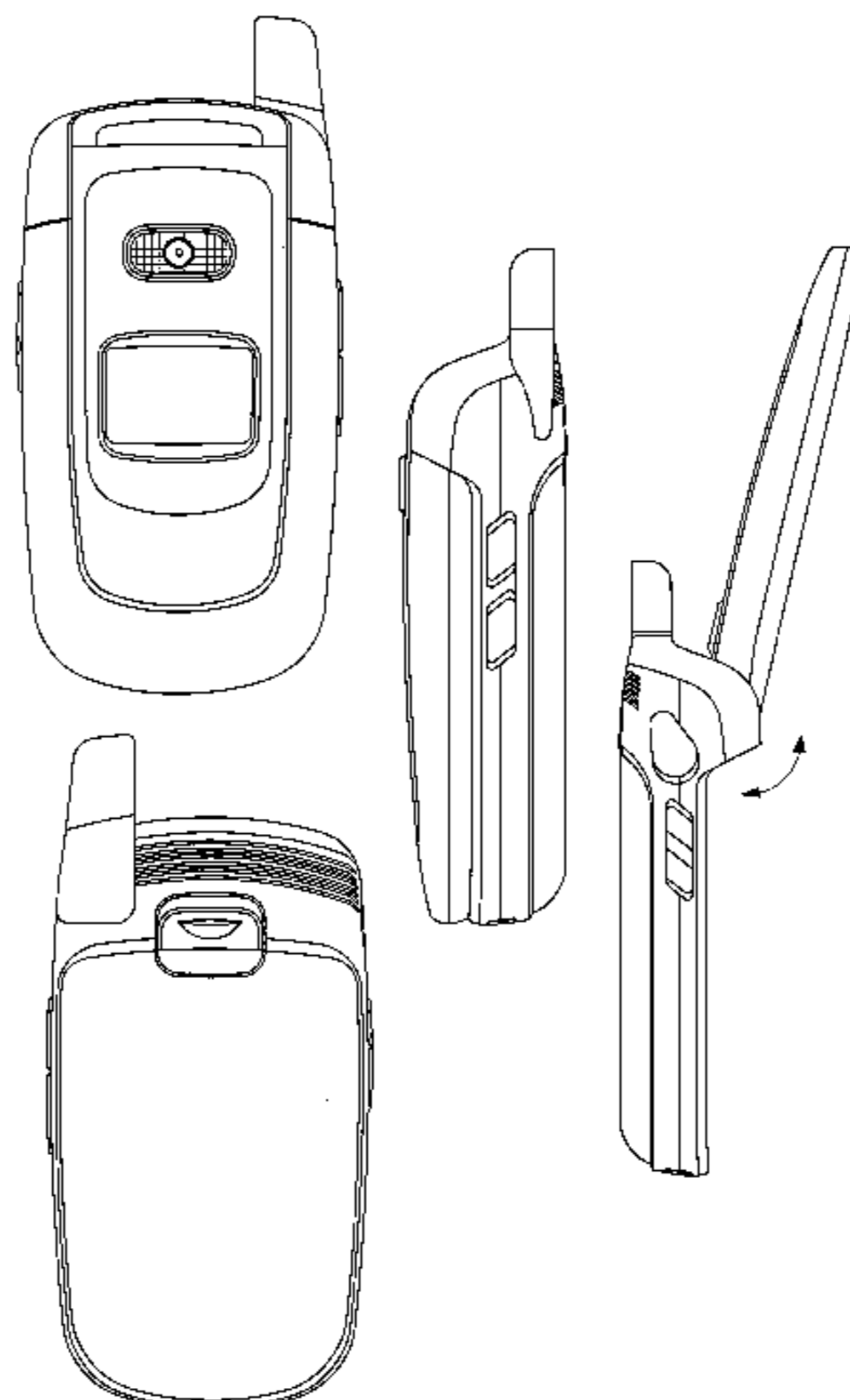

FIG. 1

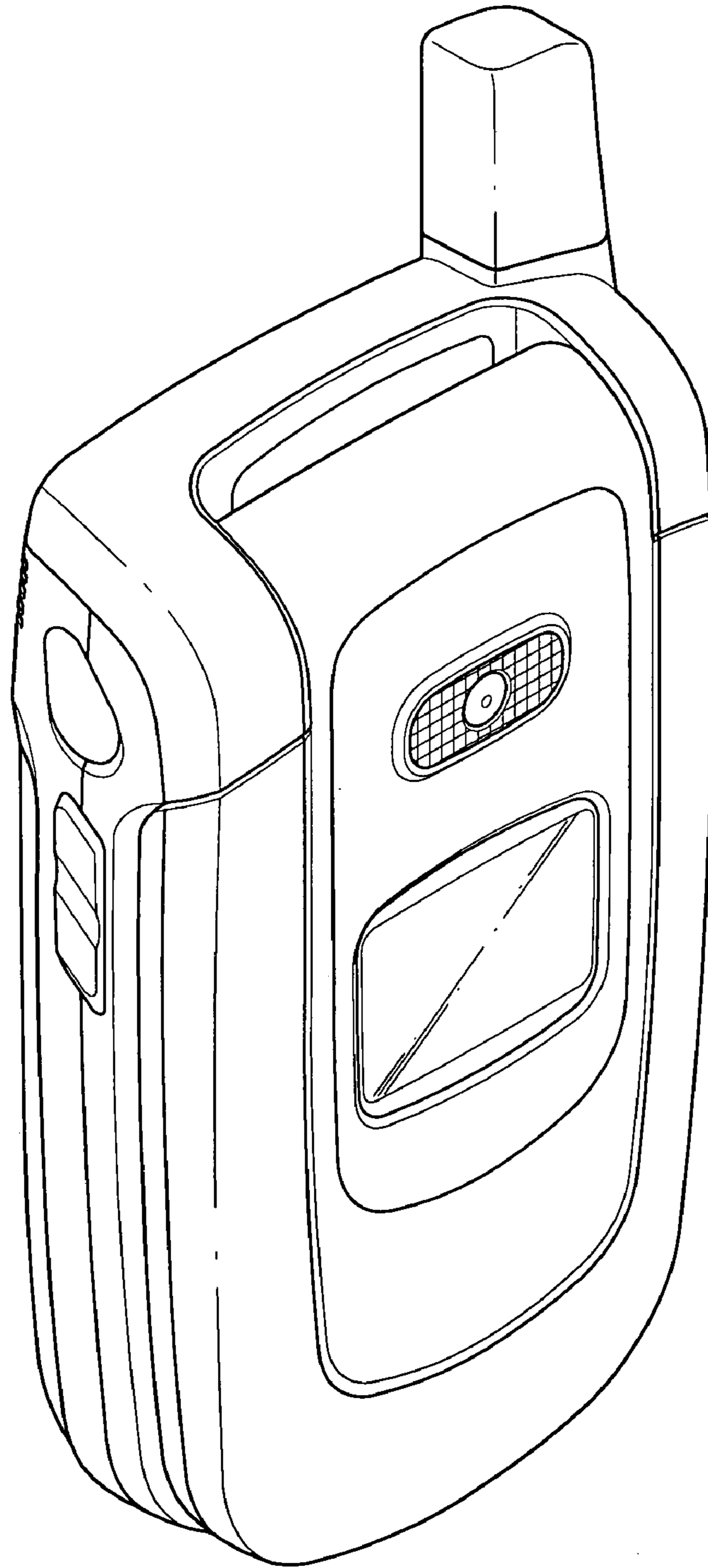

FIG. 2

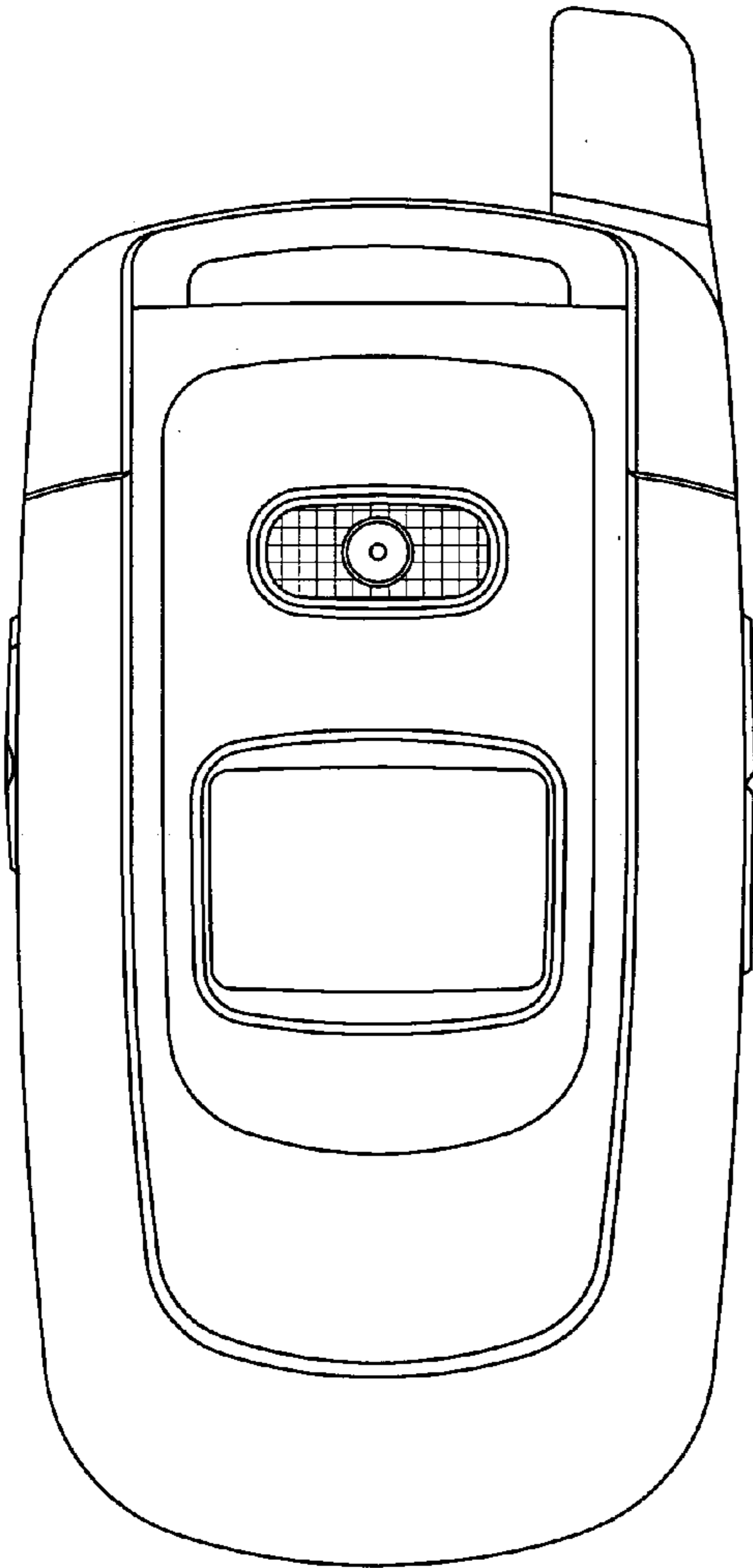

FIG. 3

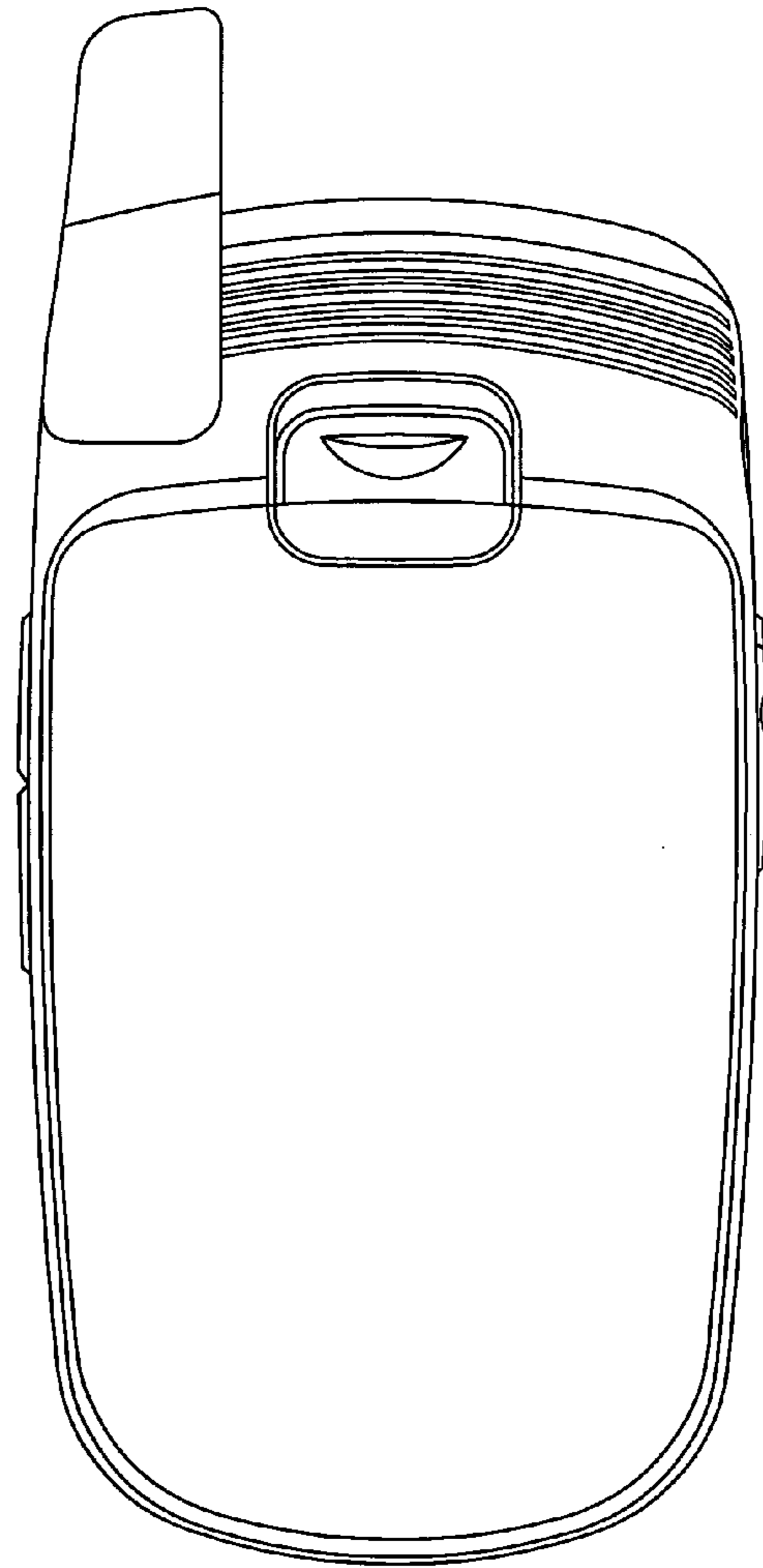

FIG. 4

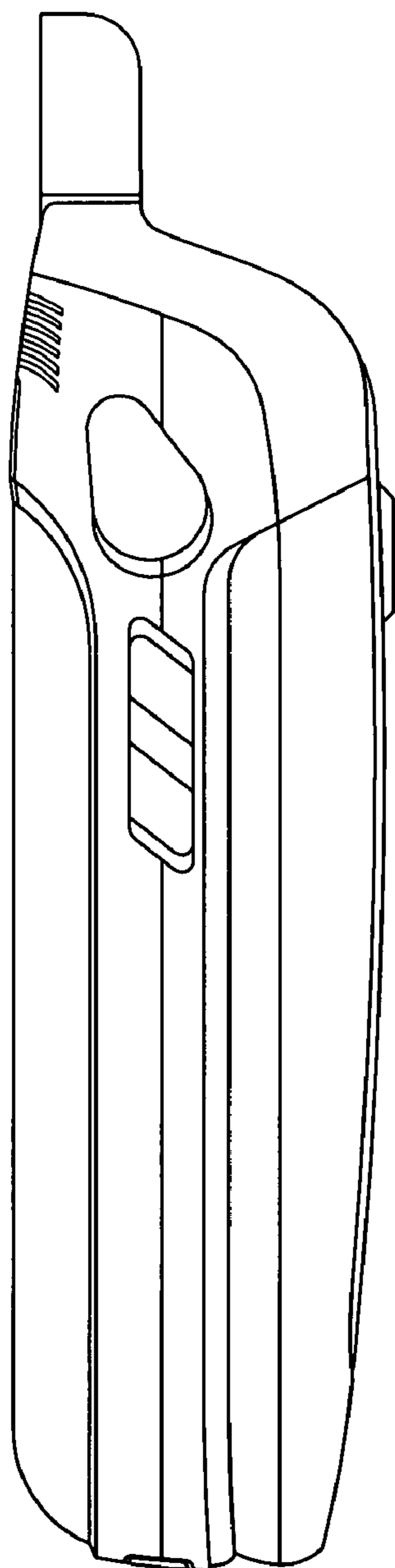

FIG. 5

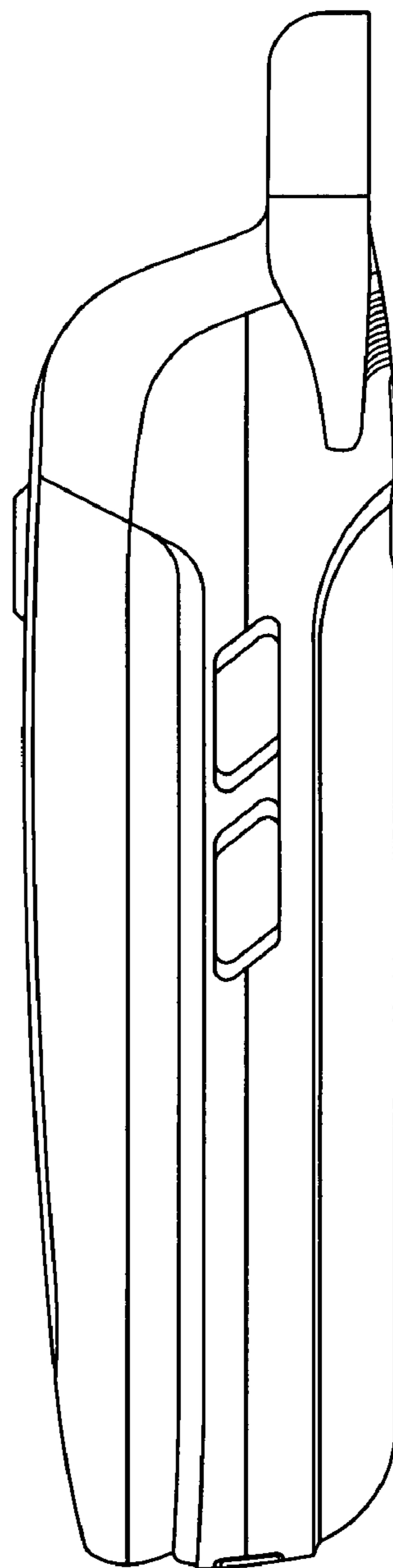

FIG. 6

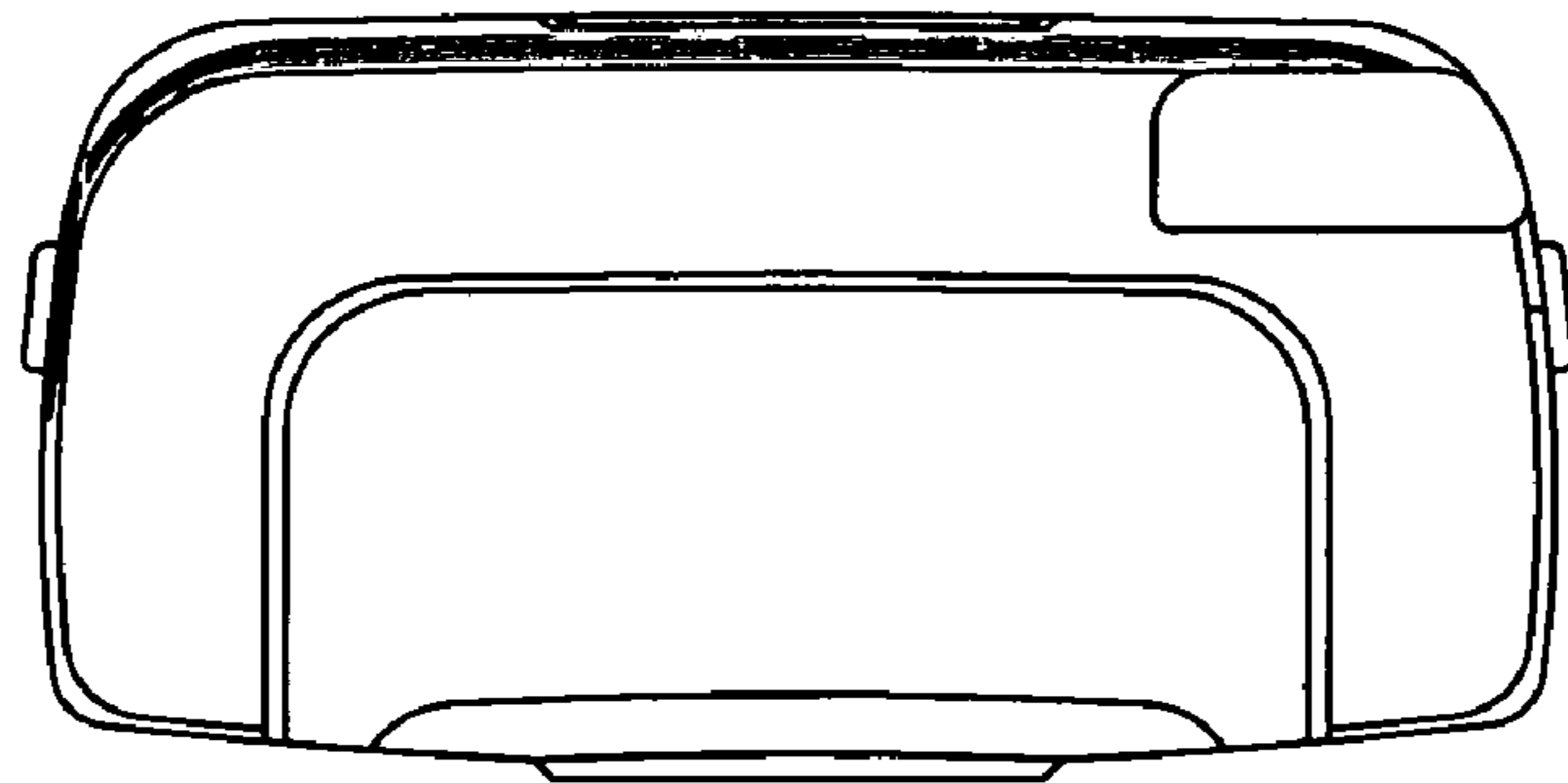

FIG. 7

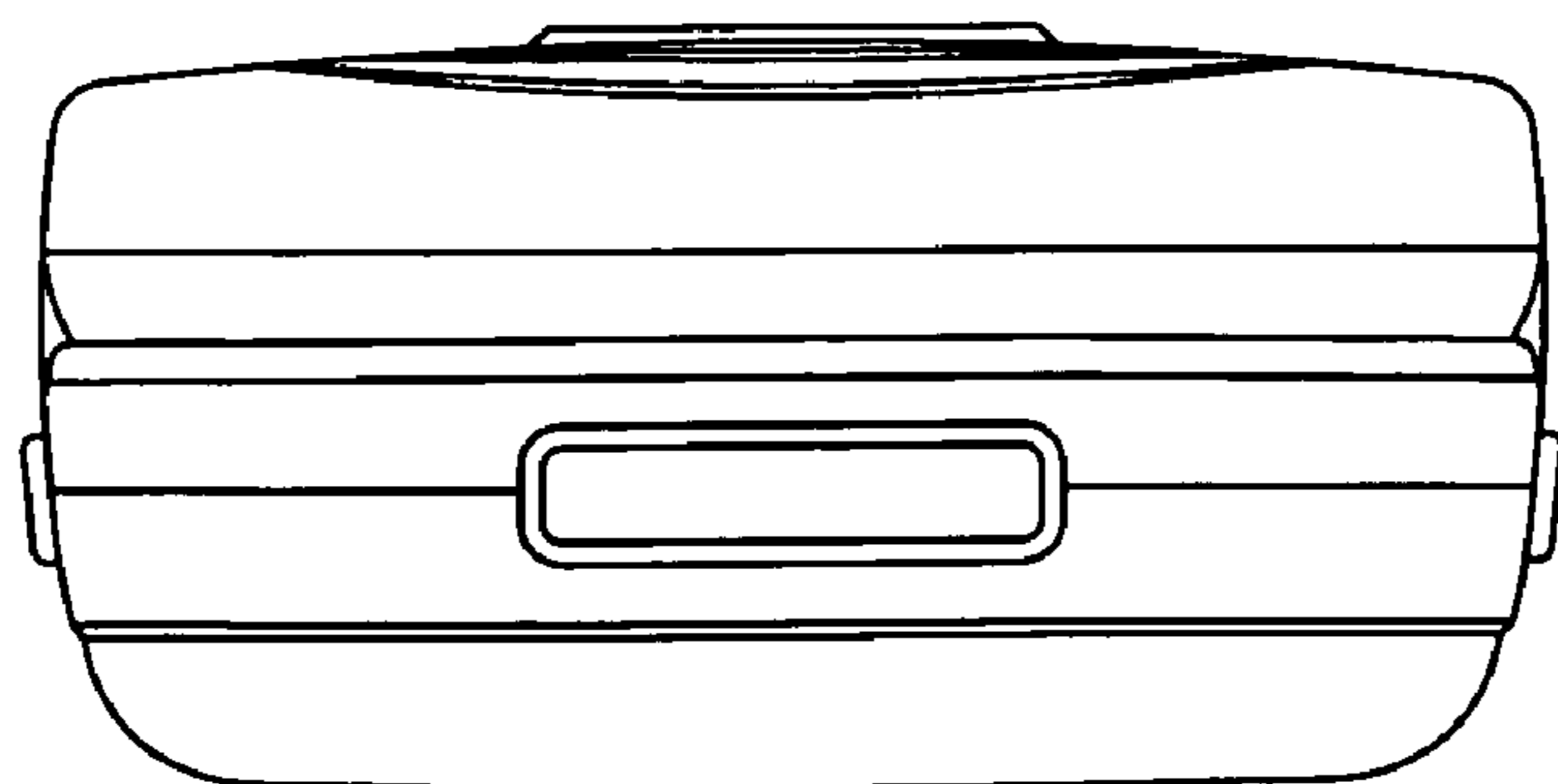

FIG. 8

