

US00D565011S

(12) **United States Design Patent**
Lee et al.

(10) **Patent No.:** **US D565,011 S**
(45) **Date of Patent:** **** Mar. 25, 2008**

(54) **PORTABLE PHONE**

(75) Inventors: **Min-Hyouk Lee**, Suwon-si (KR);
Nam-Su Kim, Seoul (KR);
Chang-Hwan Hwang, Goyang-si (KR)

(73) Assignee: **Samsung Electronics Co., Ltd.**,
Suwon-Si (KR)

(**) Term: **14 Years**

(21) Appl. No.: **29/259,853**

(22) Filed: **May 17, 2006**

(30) **Foreign Application Priority Data**

Dec. 16, 2005 (KR) 30-2005-0042612

(51) **LOC (8) Cl.** **14-03**

(52) **U.S. Cl.** **D14/138**

(58) **Field of Classification Search** D14/137,
D14/138, 147, 218, 341-347, 496; 455/90.3,
455/556.1, 556.2, 575.1, 575.3, 575.4; 379/433.01-433.13;
361/814; 348/14.02

See application file for complete search history.

(56) **References Cited**

U.S. PATENT DOCUMENTS

D479,215 S *	9/2003	Yokoyama	D14/138
D502,162 S *	2/2005	Kim et al.	D14/138
D504,120 S *	4/2005	Edoff	D14/138
D508,473 S *	8/2005	Lee et al.	D14/138
D515,060 S *	2/2006	Lee et al.	D14/138
D517,038 S *	3/2006	Lee et al.	D14/138
D526,297 S *	8/2006	Lee et al.	D14/138
D526,984 S *	8/2006	Kim et al.	D14/138
D527,367 S *	8/2006	Yun et al.	D14/138
D527,369 S *	8/2006	Chung et al.	D14/138
D527,716 S *	9/2006	Kim et al.	D14/138
D528,092 S *	9/2006	Lee et al.	D14/138
D528,533 S *	9/2006	Lee et al.	D14/138
D529,014 S *	9/2006	Kim et al.	D14/138
D529,472 S *	10/2006	Kim et al.	D14/138
D529,475 S *	10/2006	Lee et al.	D14/138
D529,888 S *	10/2006	Lee et al.	D14/138
D529,891 S *	10/2006	Hyun et al.	D14/138
D533,530 S *	12/2006	Kim et al.	D14/138

D534,144 S *	12/2006	Chung et al.	D14/138
D535,272 S *	1/2007	Kim et al.	D14/138
D535,966 S *	1/2007	Lee et al.	D14/138
2004/0185922 A1 *	9/2004	Sutton et al.	455/575.1
2005/0014527 A1 *	1/2005	Chambers et al.	455/556.1
2005/0124394 A1 *	6/2005	Kim et al.	455/575.3
2007/0032278 A1 *	2/2007	Lee et al.	455/575.4

OTHER PUBLICATIONS

Samsung Z550, announced Mar. 2006, [online], [retrieved on Feb. 8, 2007]. Retrieved from Internet ,<URL: http://www.gsmarena.com>.*

Samsung E900, announced Mar. 2006, [online], [retrieved on Feb. 8, 2007]. Retrieved from Internet ,<URL: http://www.gsmarena.com>.*

Samsung E840, announced Feb. 2007 , [online], [retrieved on Feb. 16, 2007]. Retrieved from Internet ,<URL: http://www.gsmarena.com>.*

Siemens SG75, announced Sep. 2005, [online], [retrieved on Feb. 20, 2007]. Retrieved from Internet ,<URL: http://www.gsmarena.com>.*

* cited by examiner

Primary Examiner—Jeffrey Asch

Assistant Examiner—Bridget L Eland

(74) *Attorney, Agent, or Firm*—Staas & Halsey LLP

(57) **CLAIM**

The ornamental design for the portable phone, as shown and described.

DESCRIPTION

FIG. 1 is a perspective view of the portable phone showing our design;

FIG. 2 is a front view thereof;

FIG. 3 is a rear view thereof;

FIG. 4 is a left side view thereof;

FIG. 5 is a right side view thereof;

FIG. 6 is a top plan view thereof;

FIG. 7 is a bottom plan view thereof;

FIG. 8 is a front, open view thereof; and,

FIG. 9 is a rear view, with a panel slid to an alternate position.

1 Claim, 6 Drawing Sheets

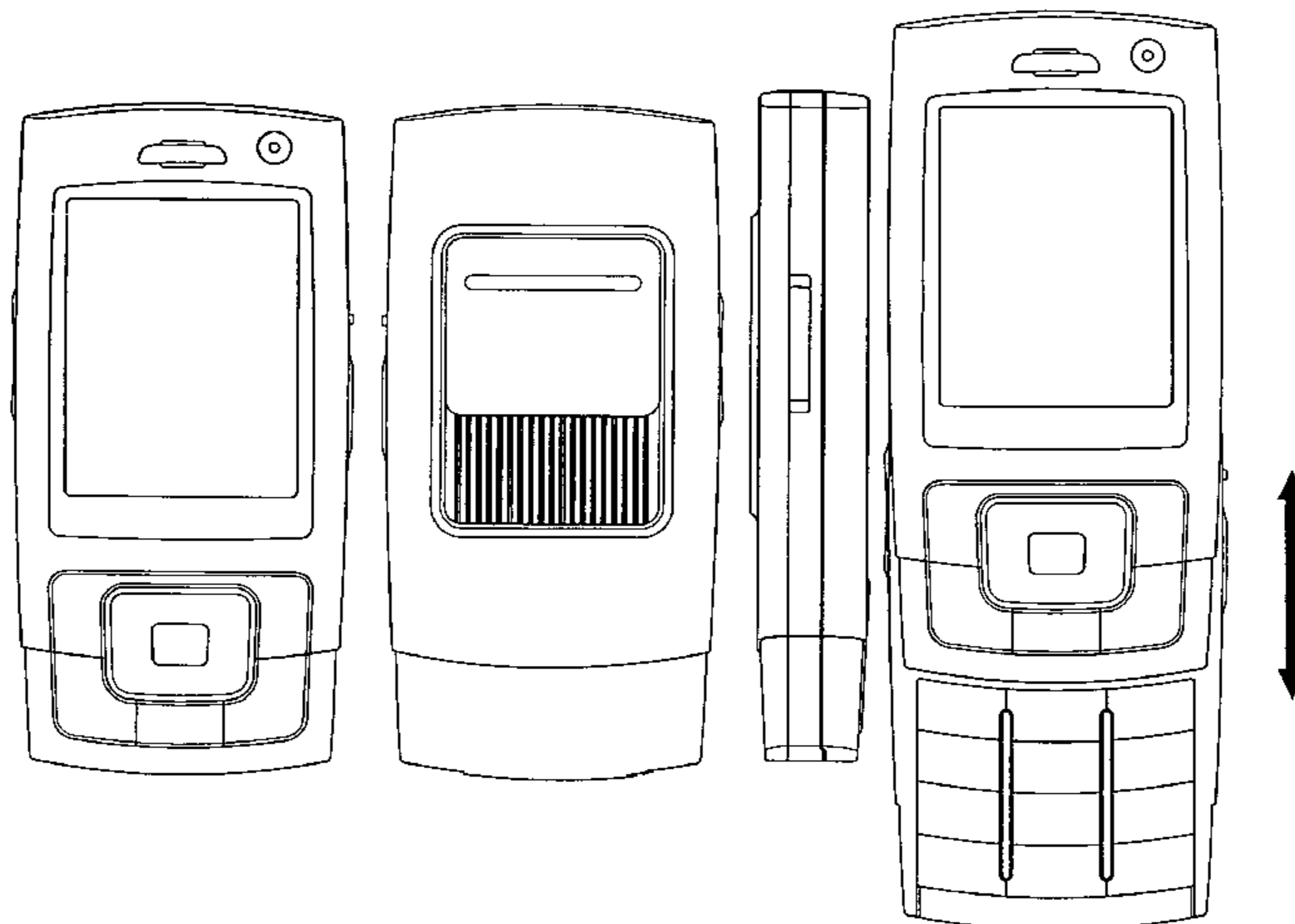

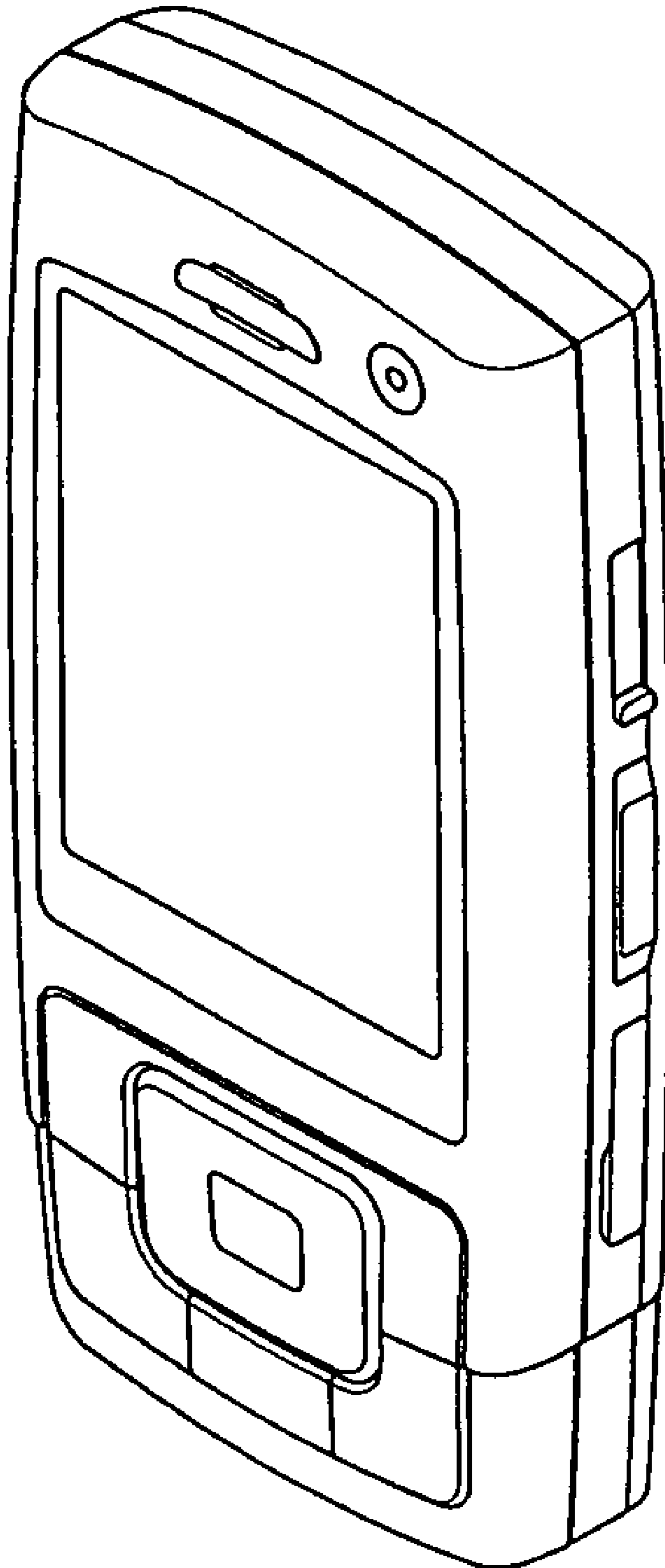

FIGURE 1

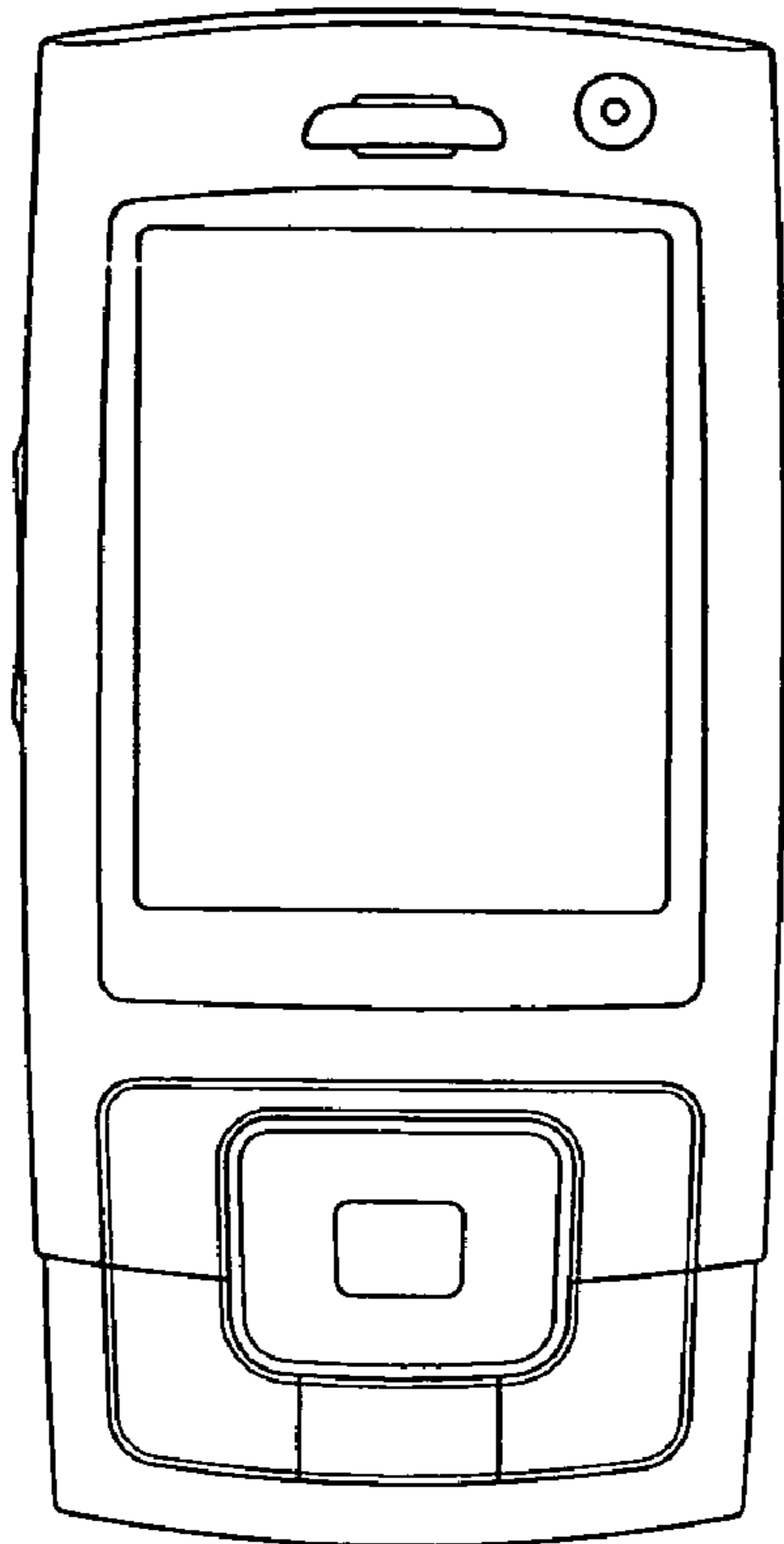

FIGURE 2

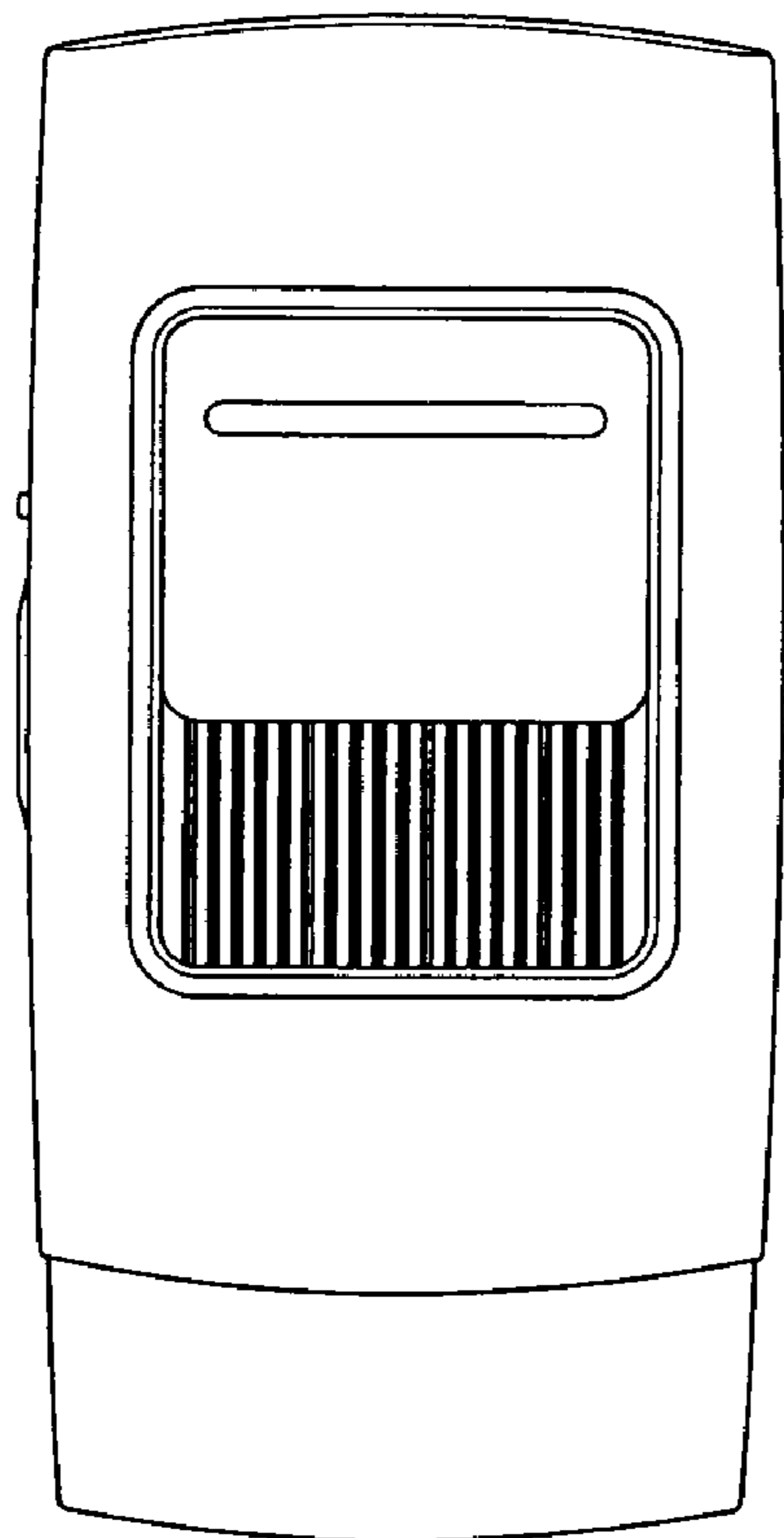

FIGURE 3

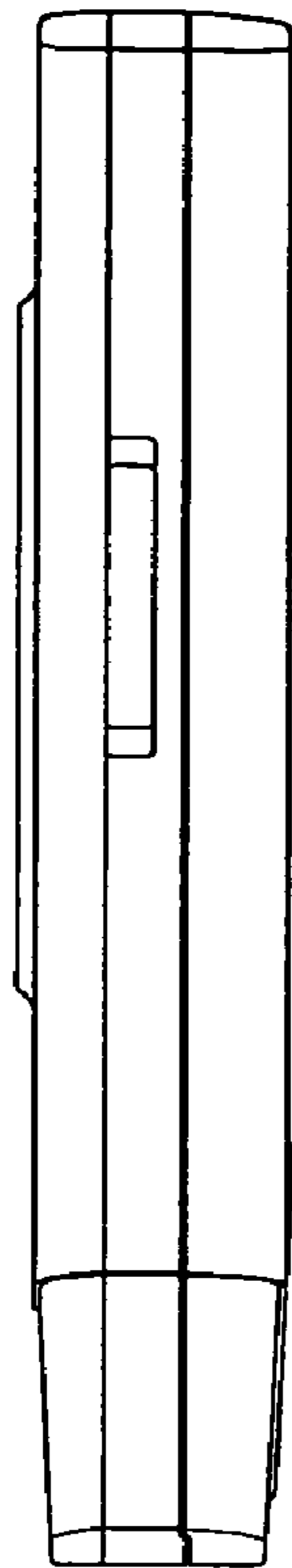

FIGURE 4

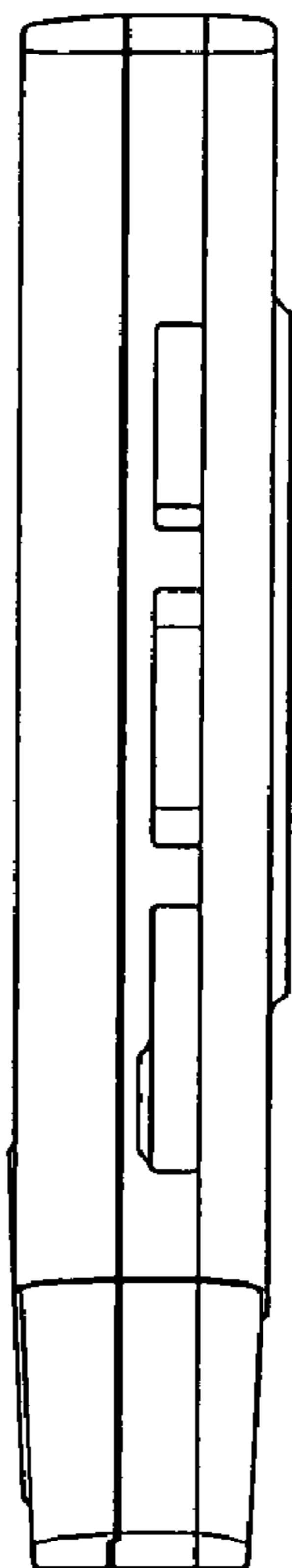

FIGURE 5

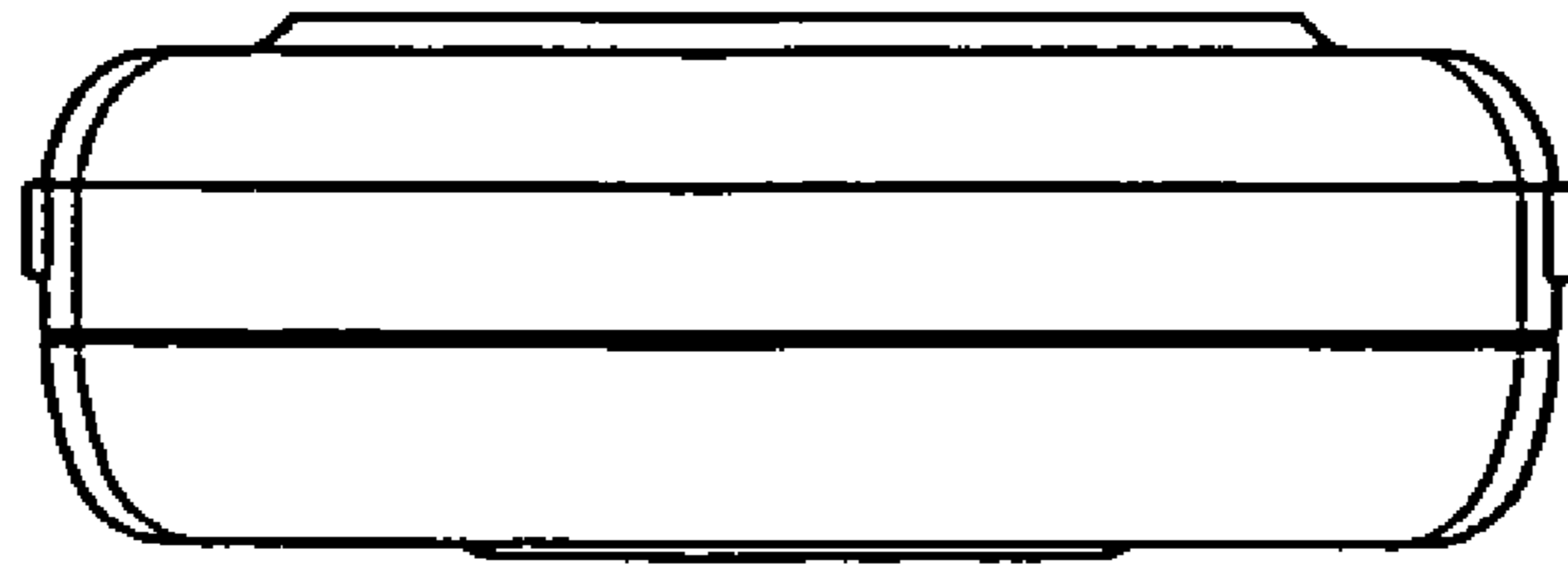

FIGURE 6

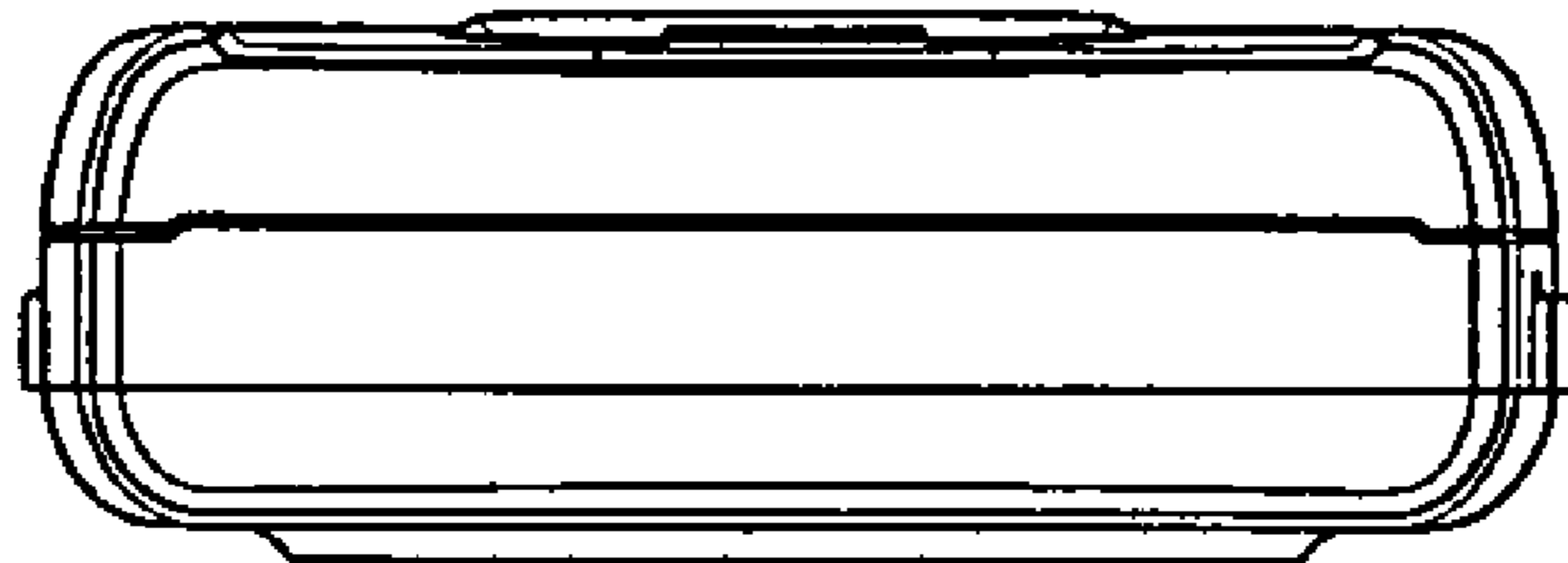

FIGURE 7

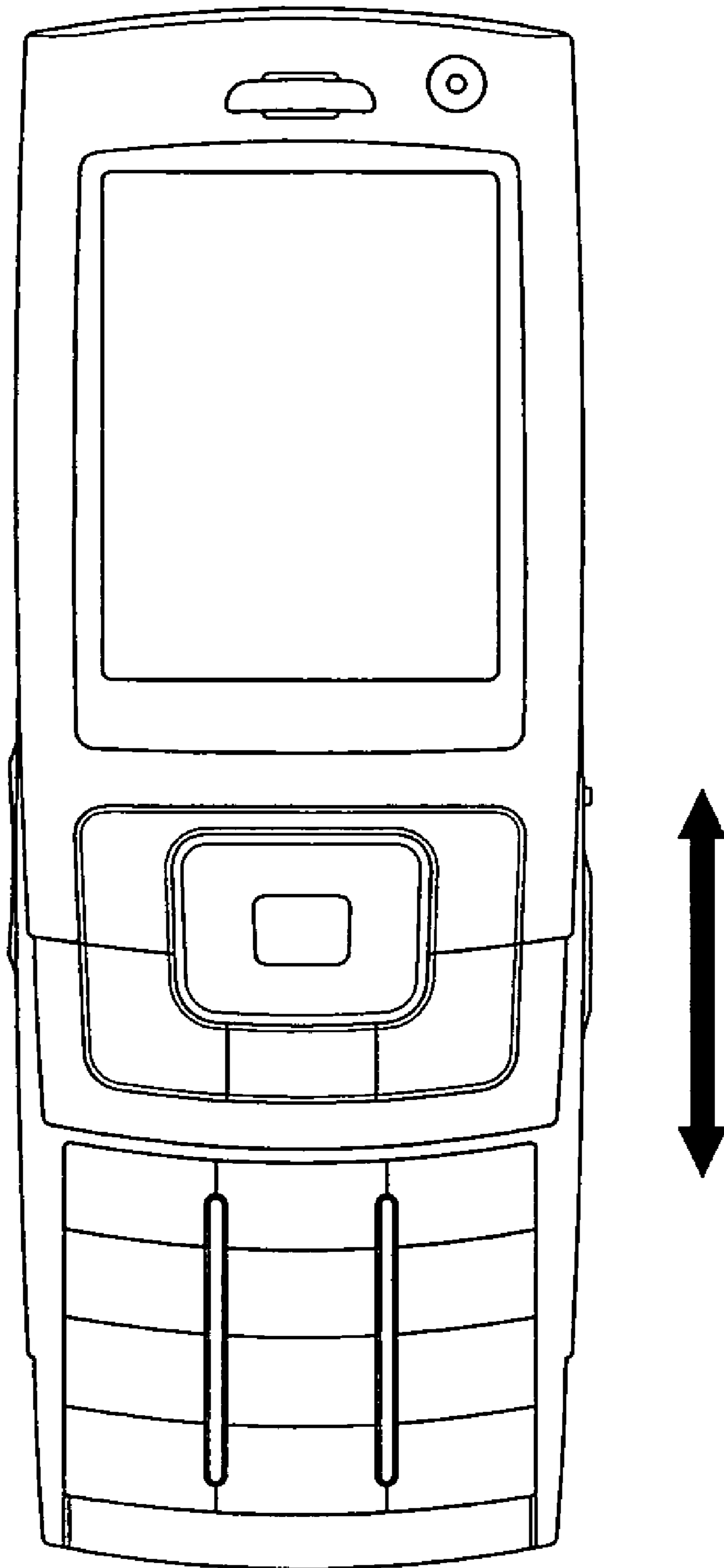

FIGURE 8

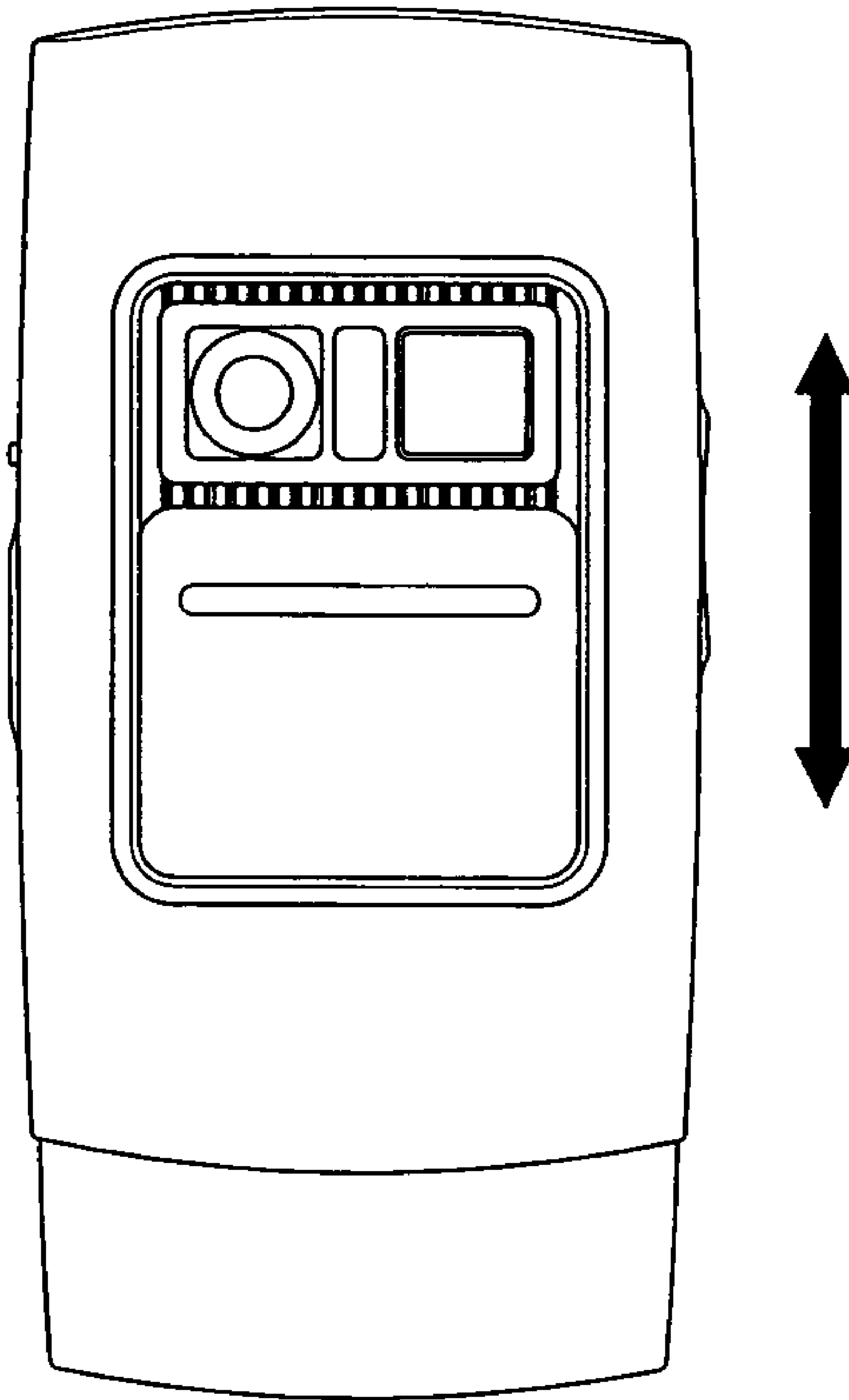

FIGURE 9