

US00D564927S

(12) **United States Design Patent**
Von Gunten

(10) **Patent No.:** **US D564,927 S**

(45) **Date of Patent:** **** Mar. 25, 2008**

(54) **COMPONENT FOR ALARM SYSTEM**

(76) **Inventor:** **Lee Von Gunten**, P.O. Box 974, West Jordan, UT (US) 84084

(**) **Term:** **14 Years**

(21) **Appl. No.:** **29/247,134**

(22) **Filed:** **Jun. 1, 2006**

(51) **LOC (8) Cl.** **10-05**

(52) **U.S. Cl.** **D10/106**

(58) **Field of Classification Search** D10/104-121;
D30/199, 152; D21/324; D14/387; D13/168,
D13/162, 164; 340/539.21, 538, 525, 825.22,
340/825.24, 825.25, 573.1-3; 119/720, 712,
119/129, 108, 106; 343/895; 54/1; 231/7
See application file for complete search history.

(56) **References Cited**

U.S. PATENT DOCUMENTS

D261,628 S *	11/1981	Schaeffer	D10/106
D274,428 S *	6/1984	Bottner	D14/245
D287,717 S *	1/1987	Farwell et al.	D13/164
D297,128 S *	8/1988	Guscott et al.	D10/106
D301,844 S *	6/1989	Schwarz et al.	D10/109

D346,755 S *	5/1994	Soloway	D10/106
D401,178 S *	11/1998	Liu	D10/106
D453,693 S *	2/2002	Schumacher et al.	D10/65
D456,364 S *	4/2002	Suen	D13/162
D487,064 S *	2/2004	Stekelenburg	D13/168
2006/0158342 A1 *	7/2006	Rogers	340/825.25

* cited by examiner

Primary Examiner—Robert M. Spear
Assistant Examiner—George D Kirschbaum
(74) *Attorney, Agent, or Firm*—Geoffrey E. Dobbin

(57) **CLAIM**

The ornamental design for a component for alarm system, as shown and described.

DESCRIPTION

FIG. 1 is a front side plan view of the component.
FIG. 2 is a right elevation view of the component.
FIG. 3 is a back side plan view of the component.
FIG. 4 is a top elevation of the component; and,
FIG. 5 is a rear perspective view of the component.

1 Claim, 2 Drawing Sheets

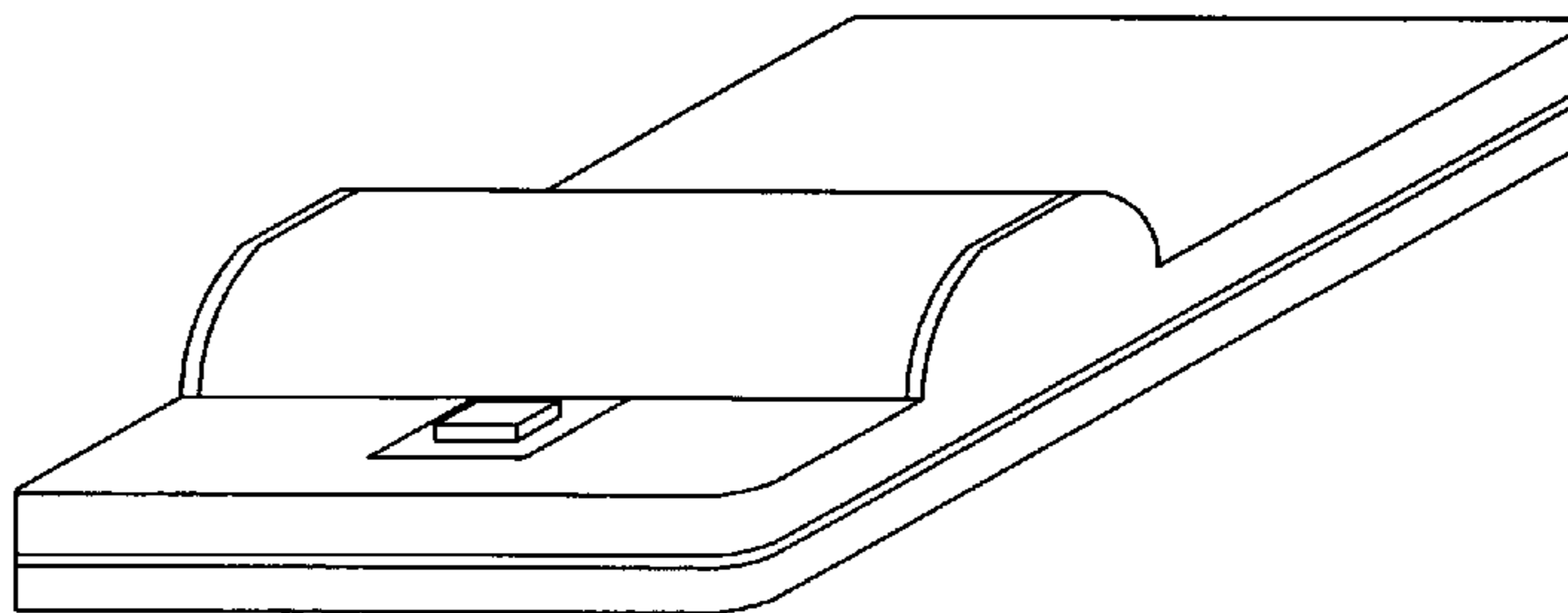
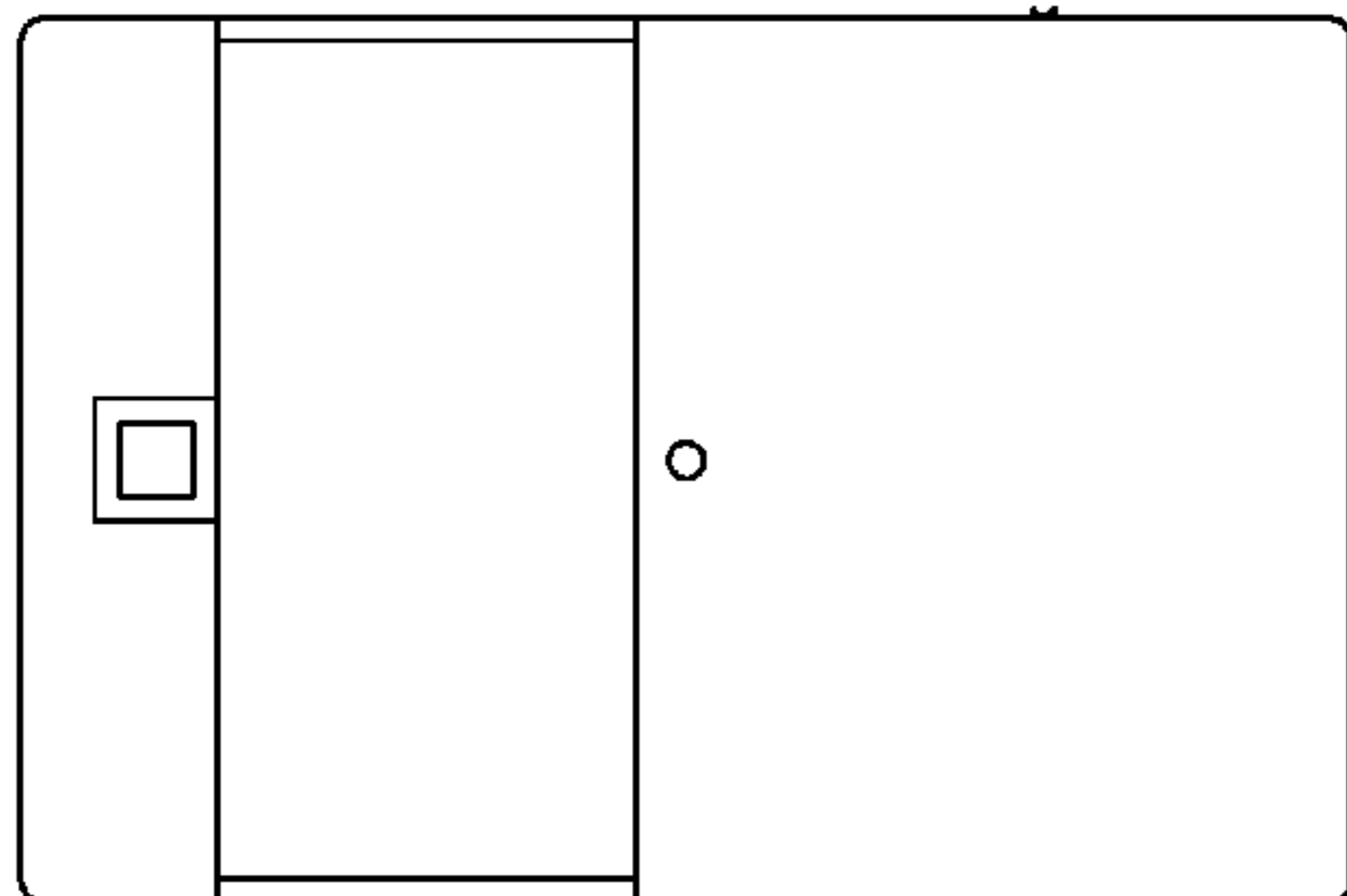
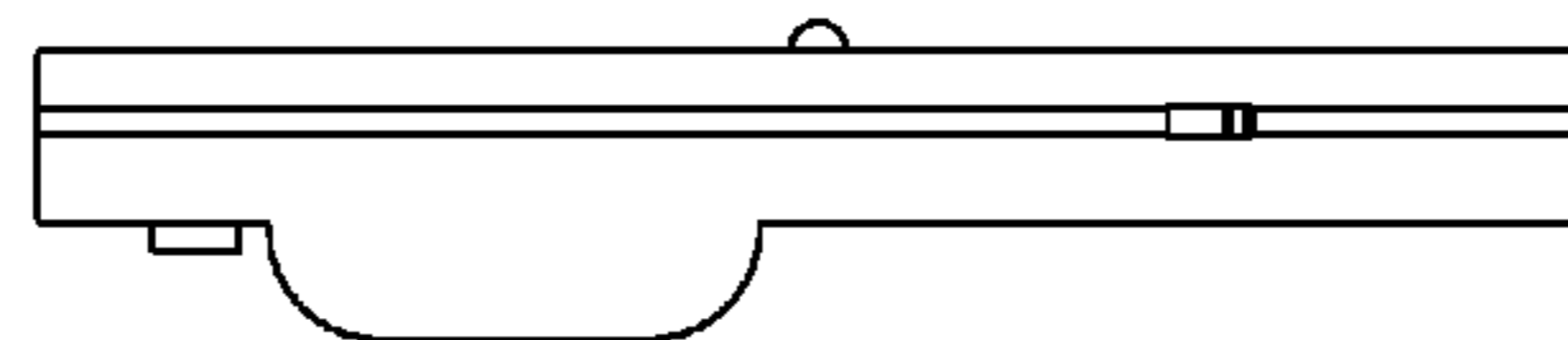
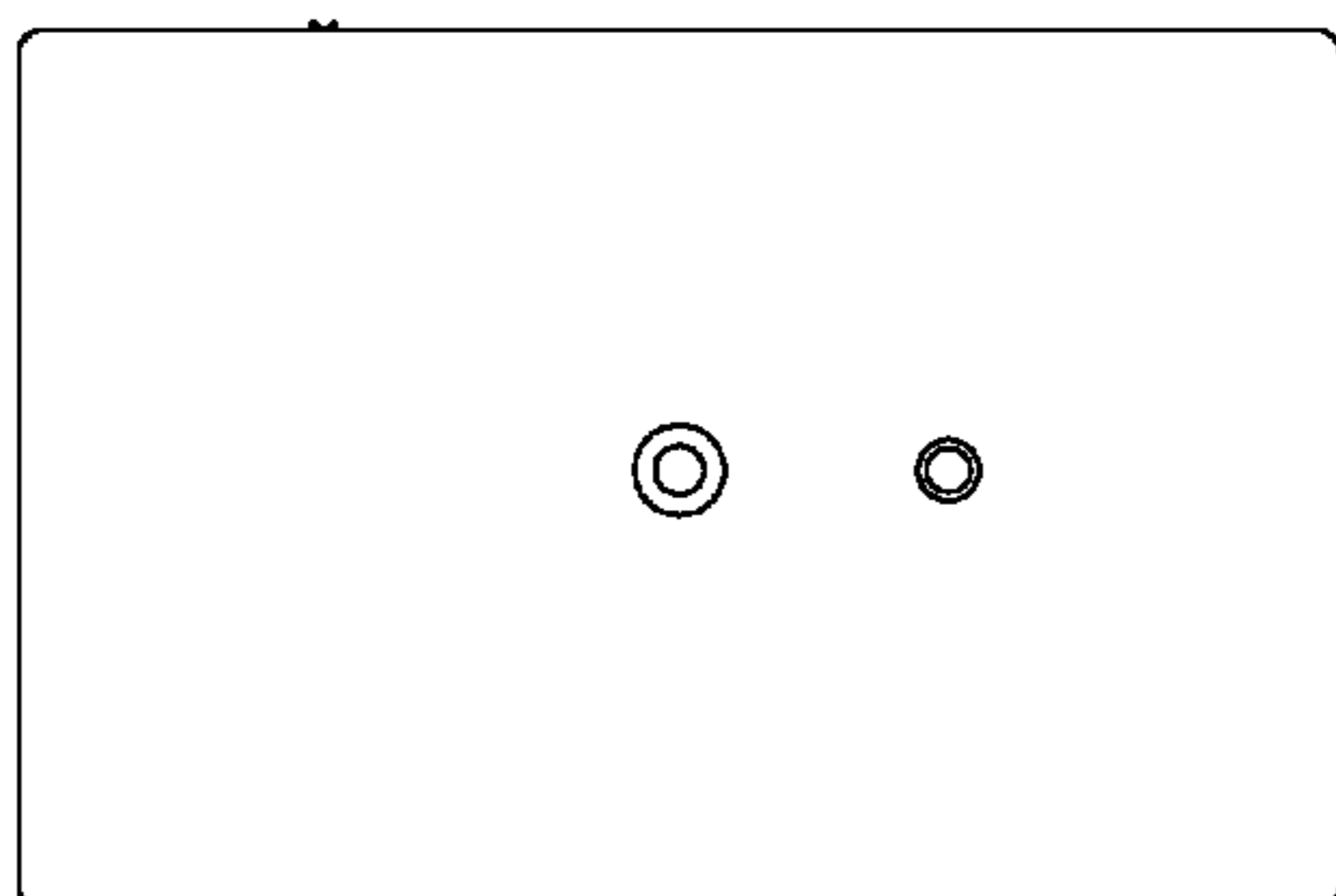

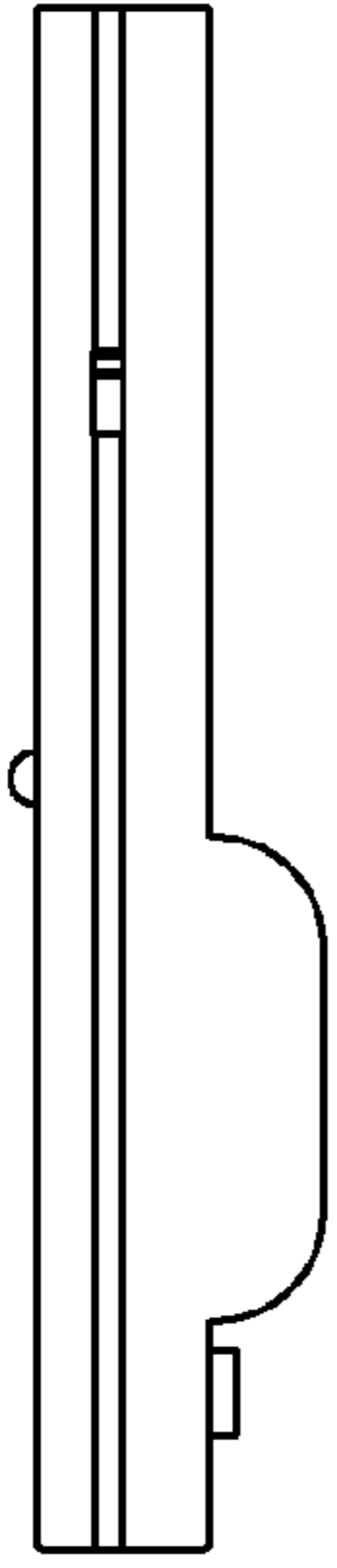

FIGURE 4

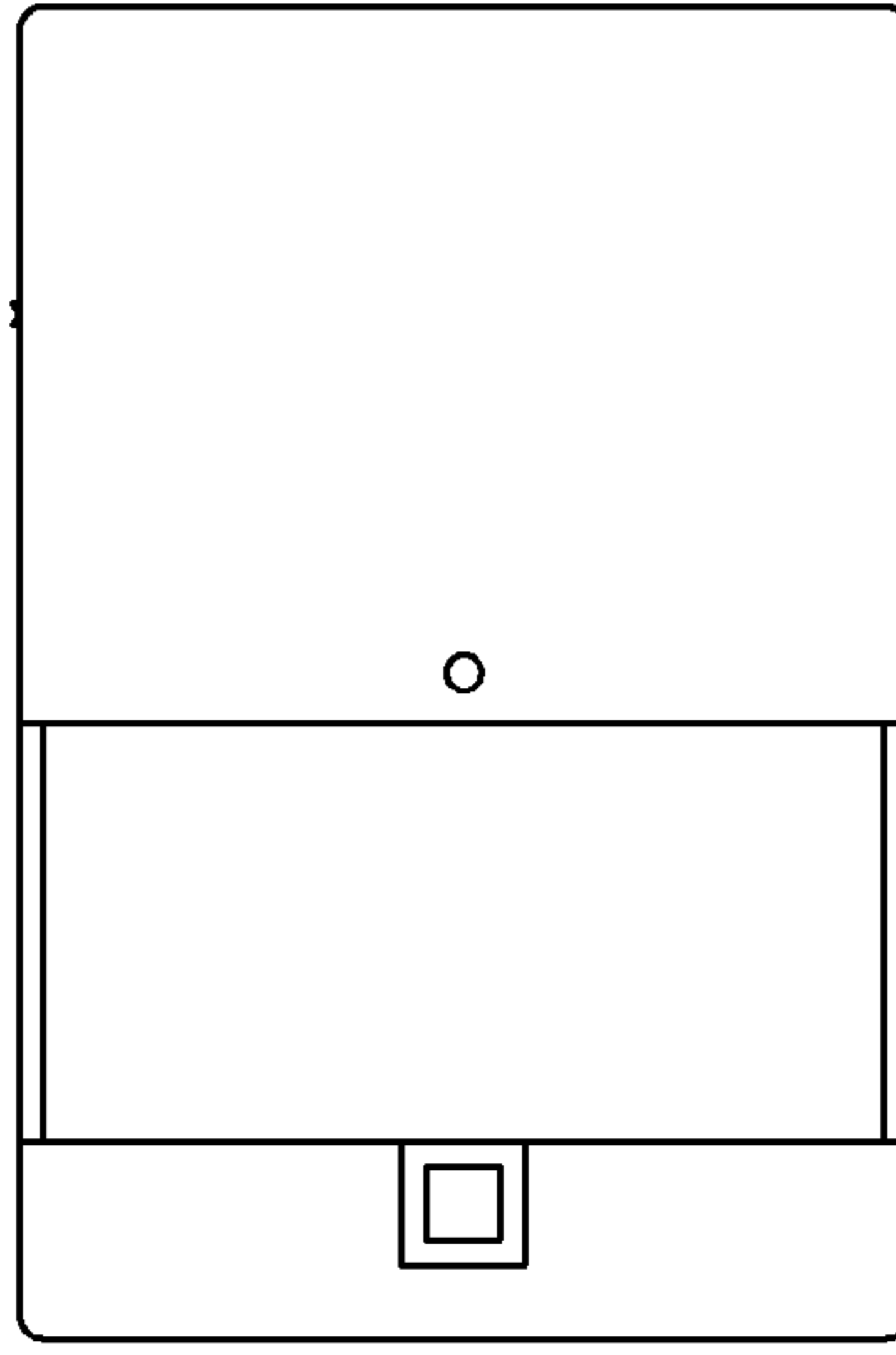

FIGURE 3

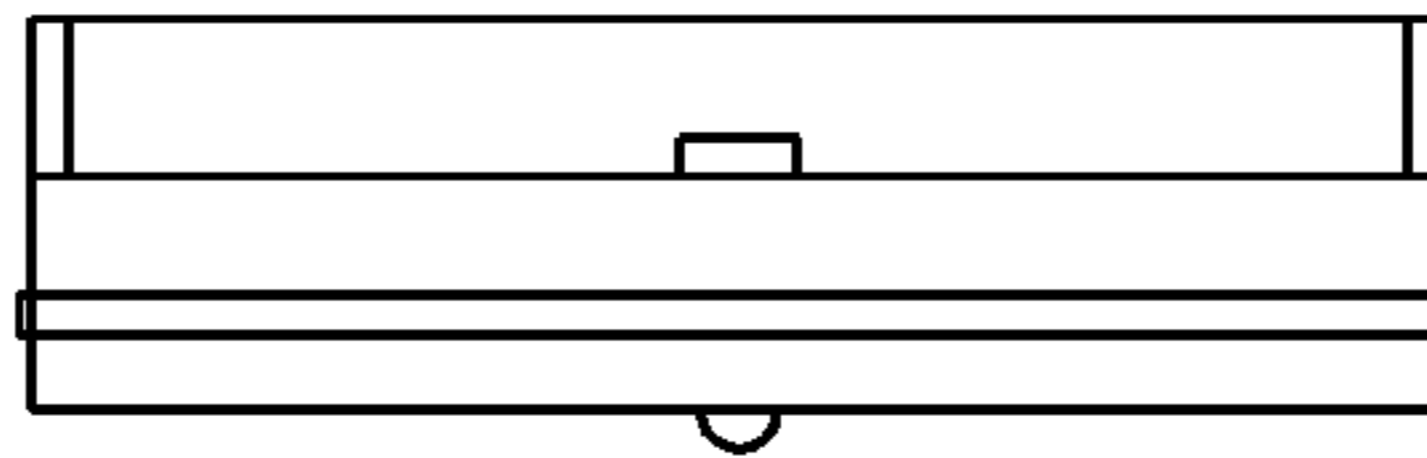

FIGURE 2

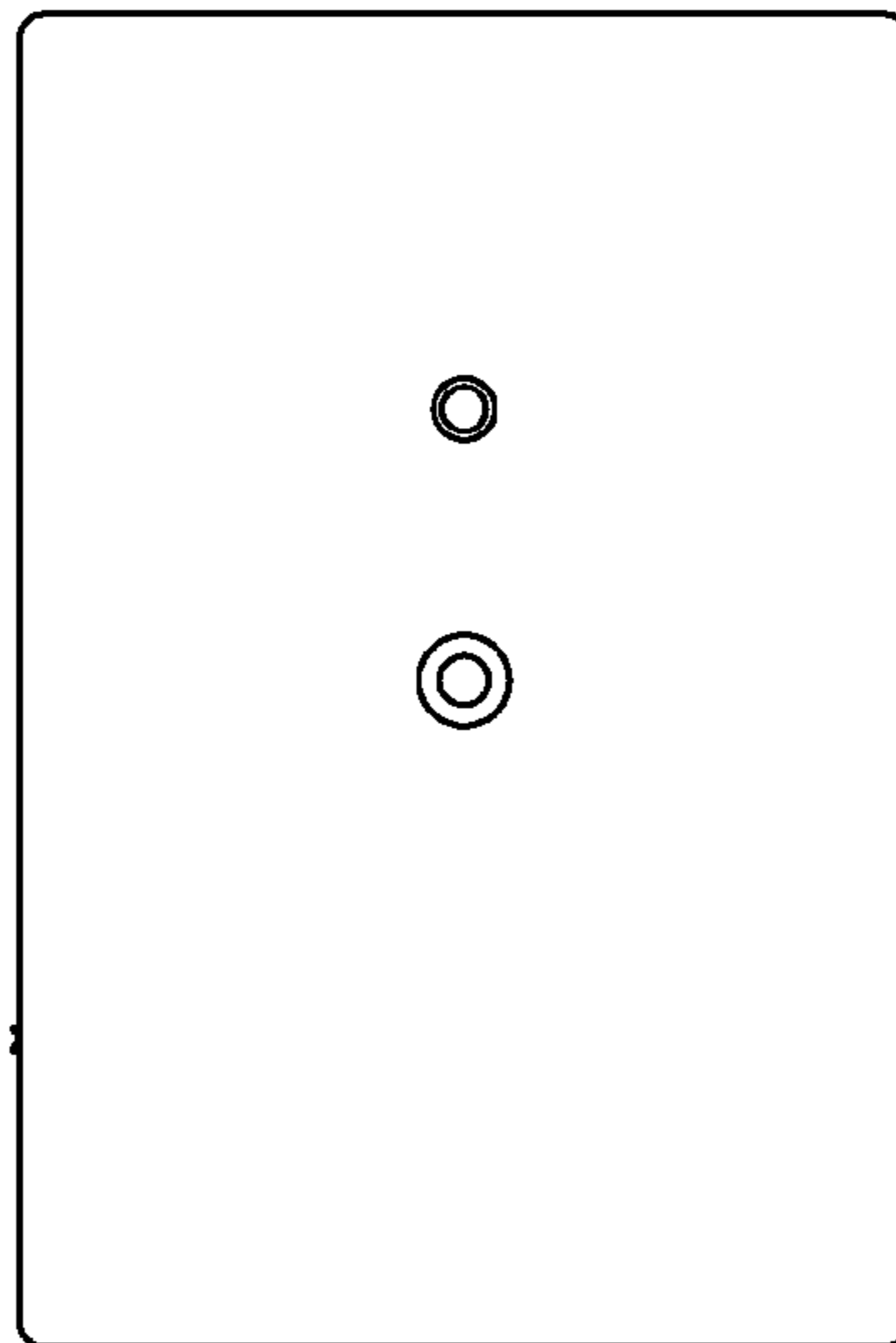

FIGURE 1

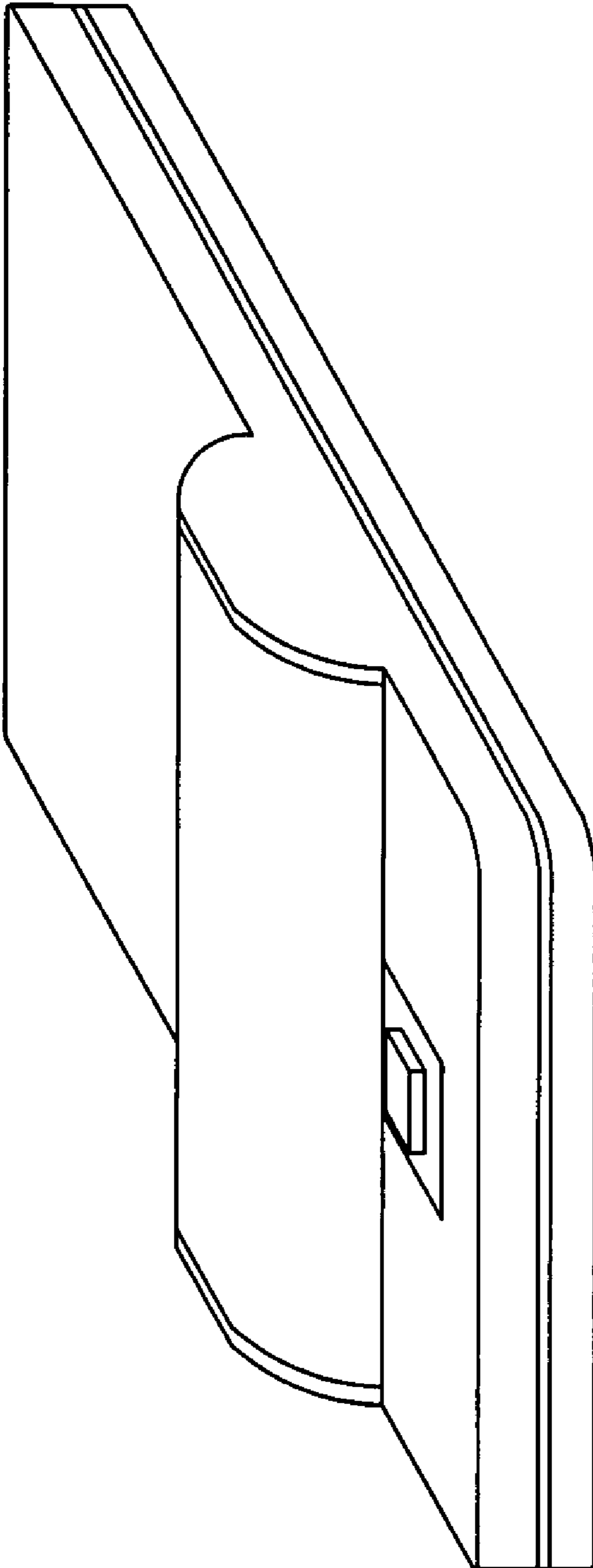

FIGURE 5