



US00D564910S

(12) **United States Design Patent**
Rabassa

(10) **Patent No.:** **US D564,910 S**
(45) **Date of Patent:** **** Mar. 25, 2008**

(54) **WATCH**

(75) **Inventor:** **Serge Rabassa**, Geneva (CH)

(73) **Assignee:** **Cartier Creation Studio S.A.**, Geneva (CH)

(**) **Term:** **14 Years**

(21) **Appl. No.:** **29/280,811**

(22) **Filed:** **Jun. 7, 2007**

(30) **Foreign Application Priority Data**

Dec. 15, 2006 (EM) 000638333-0003

(51) **LOC (8) Cl.** **10-02**

(52) **U.S. Cl.** **D10/39**

(58) **Field of Classification Search** D10/30-39,
D10/123-126; 368/276, 281, 282, 285, 80,
368/223, 21, 28, 228, 232

See application file for complete search history.

(56) **References Cited**

U.S. PATENT DOCUMENTS

D65,621 S *	9/1924	Strasser	D10/38
D65,622 S *	9/1924	Strasser	D10/38
D74,134 S *	12/1927	Beckmann	D10/30
D250,694 S *	1/1979	Perrin	D10/39
D386,979 S *	12/1997	Kubisch	D10/32
D430,809 S *	9/2000	Polenberg	D10/39
6,275,450 B1 *	8/2001	Makiba	368/80

D470,776 S *	2/2003	Blondin	D10/30
6,570,823 B1 *	5/2003	Gilomen et al.	368/113
D476,580 S *	7/2003	Calvani et al.	D10/30
D476,908 S *	7/2003	Ellia	D10/39
D508,860 S *	8/2005	Plan	D10/39
D512,654 S *	12/2005	Scheufele	D10/39
D517,929 S *	3/2006	Rabassa	D10/39
D520,378 S *	5/2006	Miotto	D10/30
D532,320 S *	11/2006	Arabo	D10/38
D533,089 S *	12/2006	Arabo	D10/39
D539,675 S *	4/2007	Chastaingt	D10/39

* cited by examiner

Primary Examiner—Lucy Lieberman

(74) *Attorney, Agent, or Firm*—Kalow & Springut, LLP

(57) **CLAIM**

The ornamental design for a watch, as shown and described.

DESCRIPTION

FIG. 1 is a perspective view of the watch.

FIG. 2 is a top view of the watch.

FIG. 3 is a bottom view of the watch.

FIG. 4 is a front view of the watch.

FIG. 5 is a rear view of the watch.

FIG. 6 is a right side view of the watch; and,

FIG. 7 is a left side view of the watch.

1 Claim, 5 Drawing Sheets

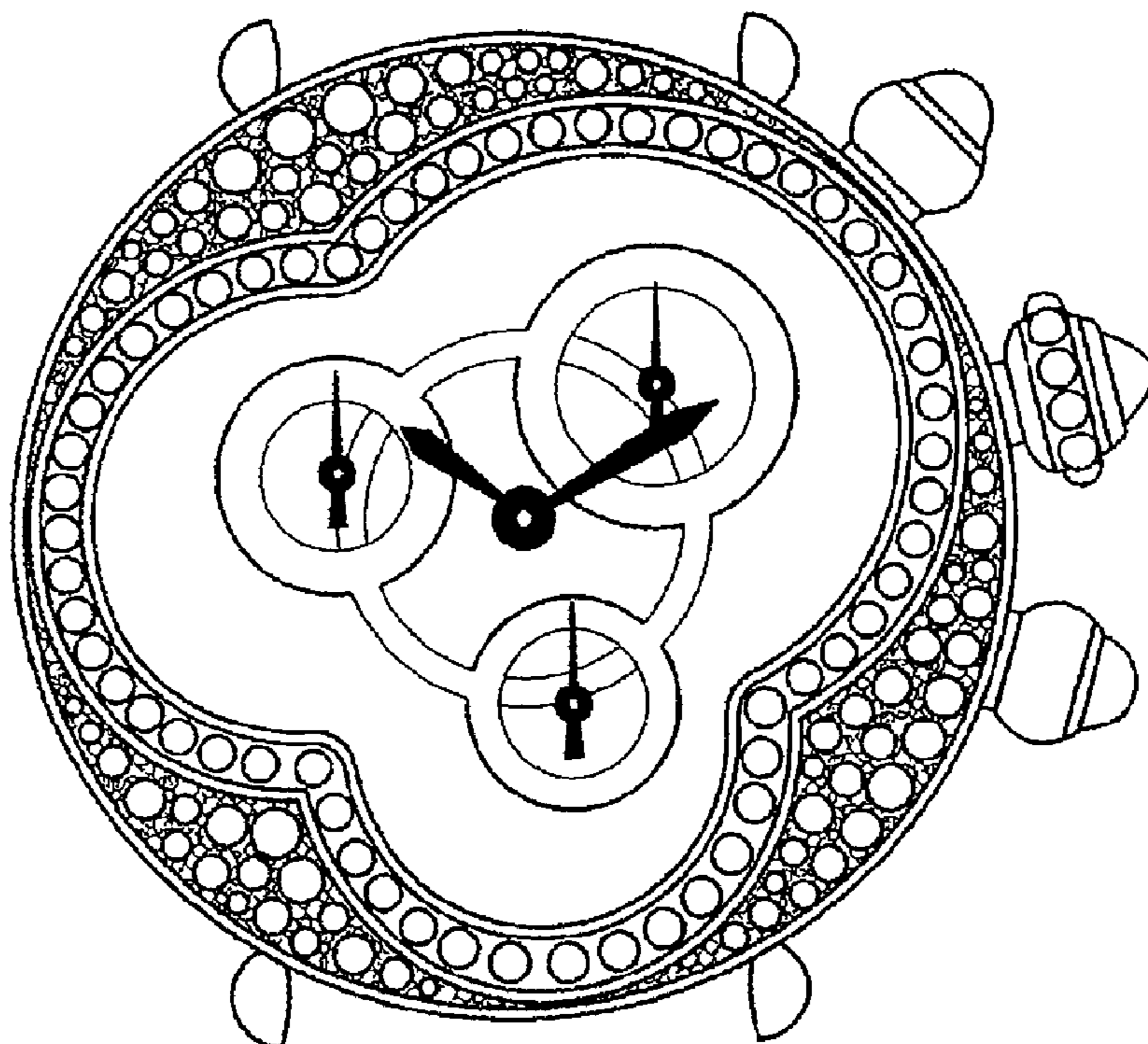

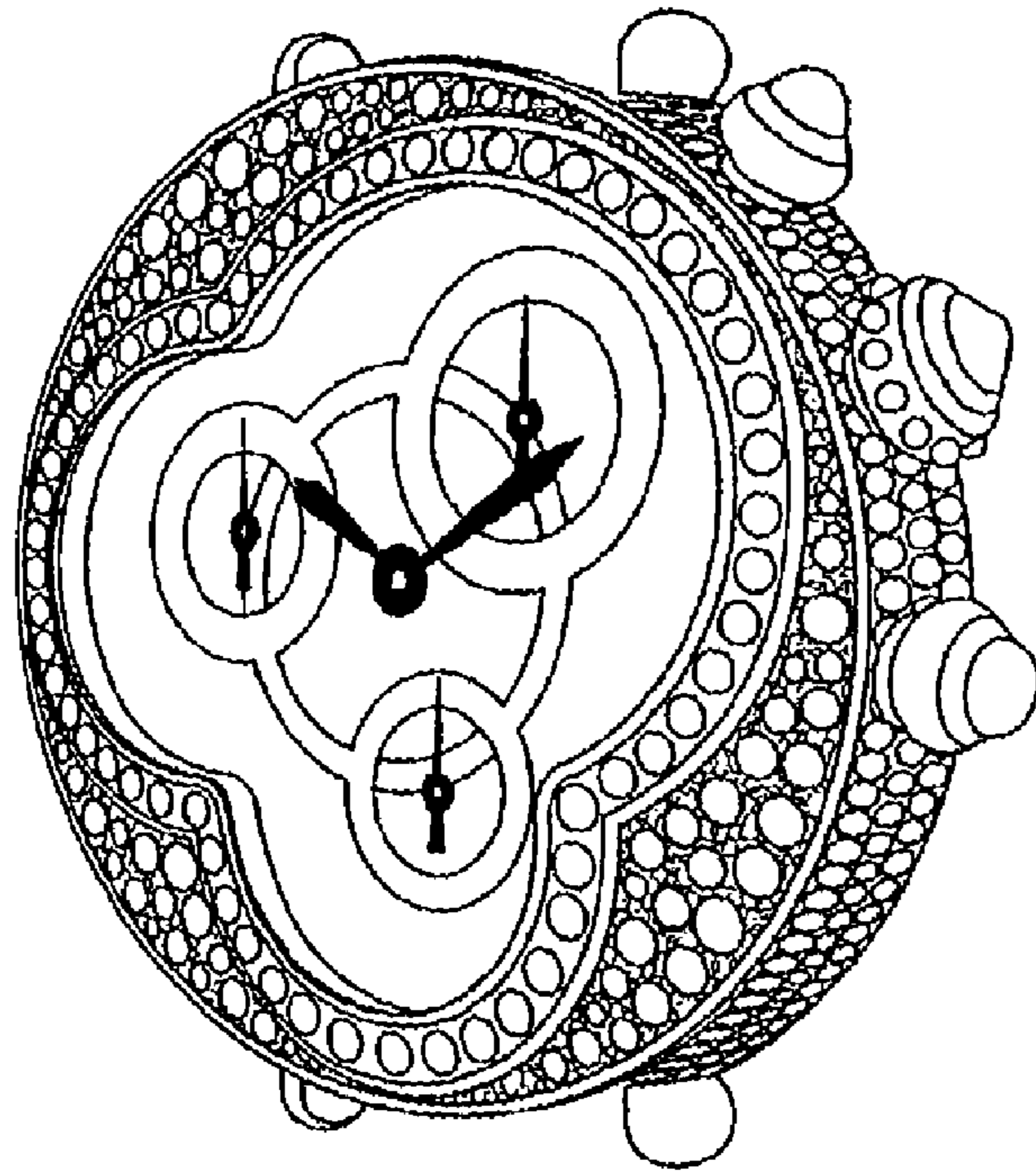

FIG. 1

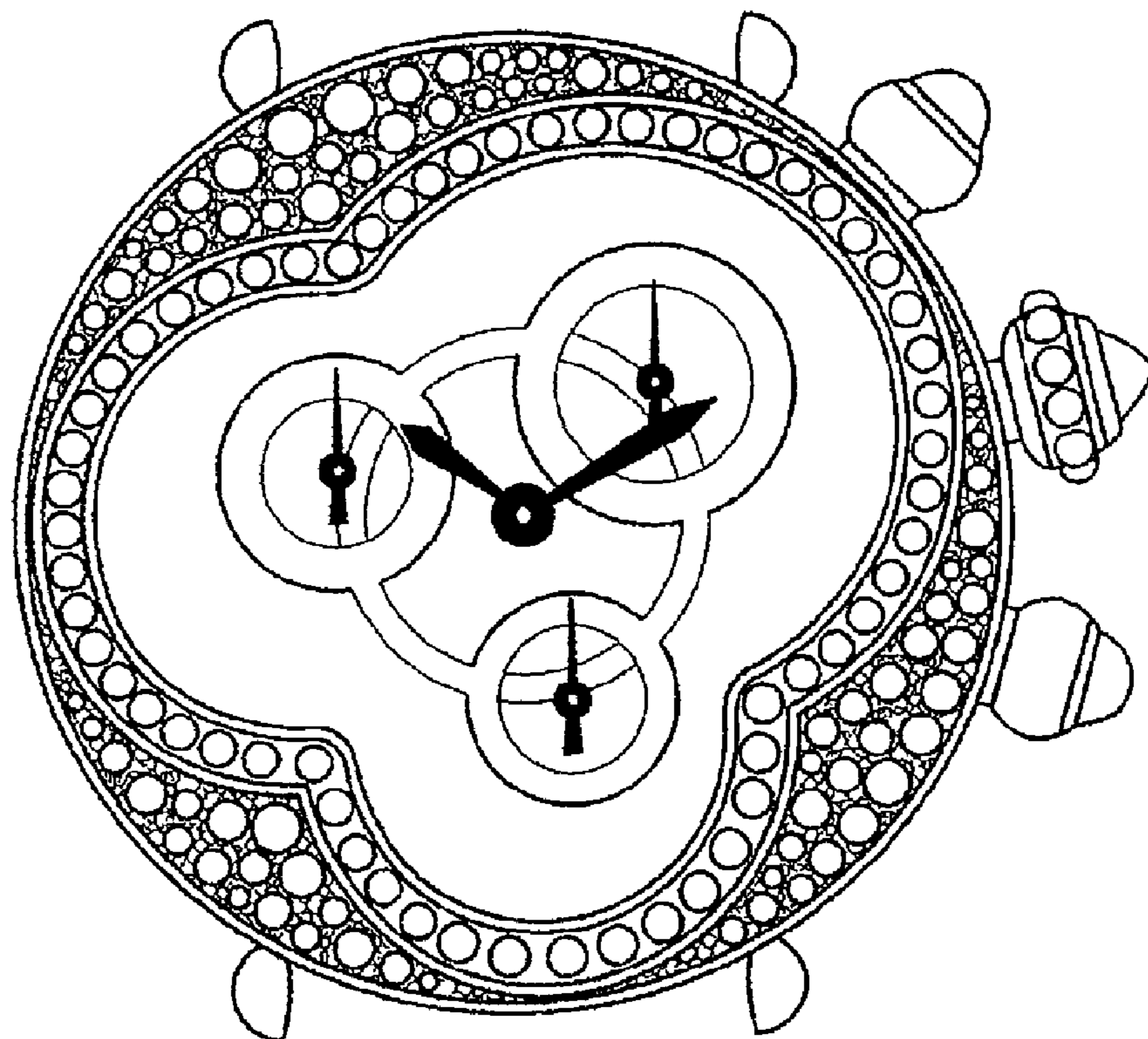

FIG. 2

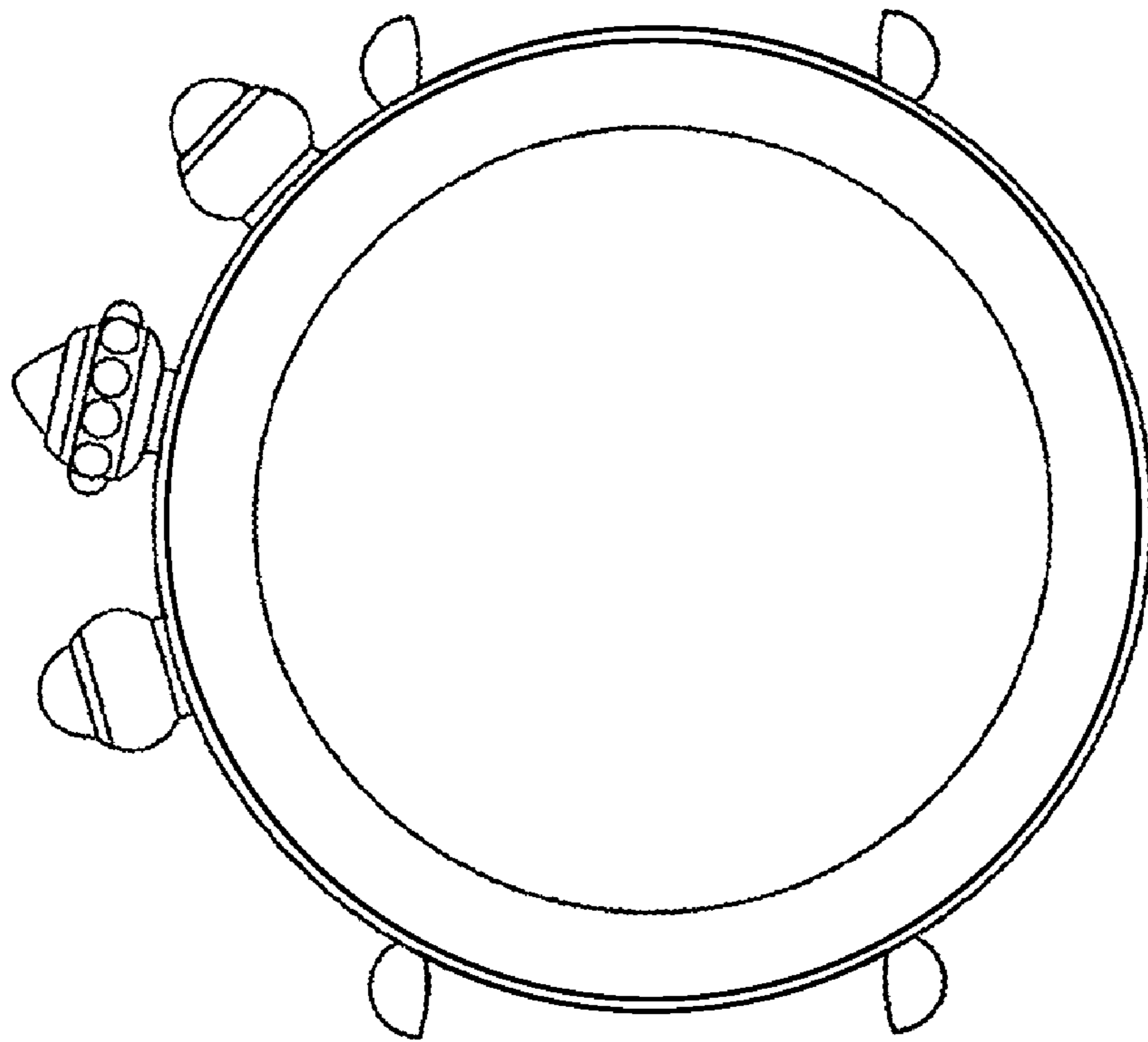

FIG. 3

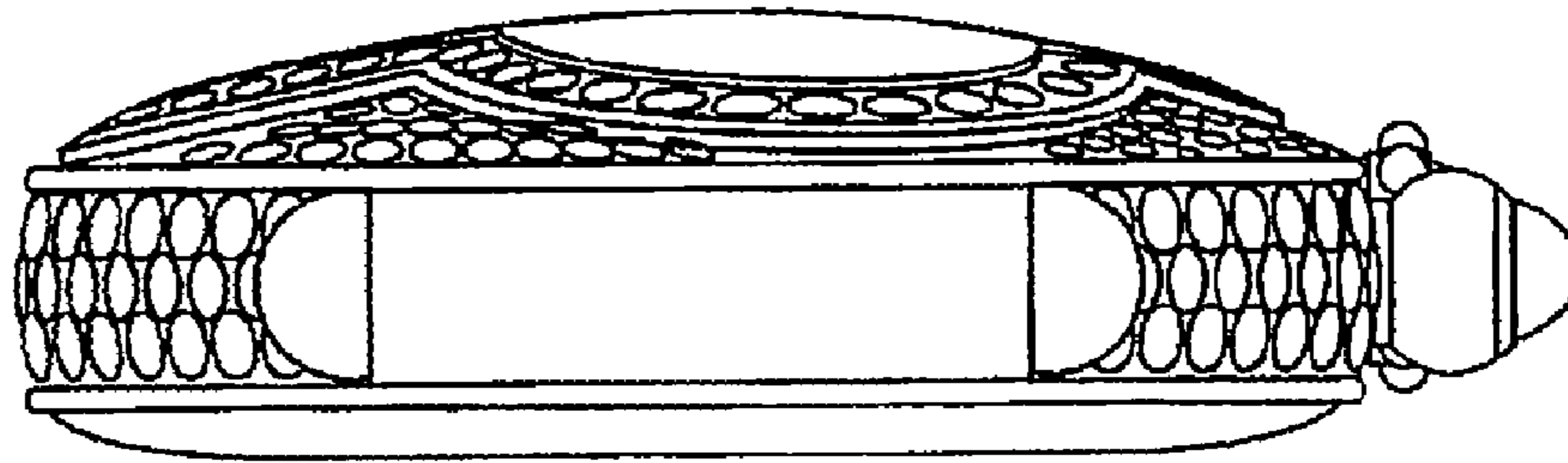

FIG. 4

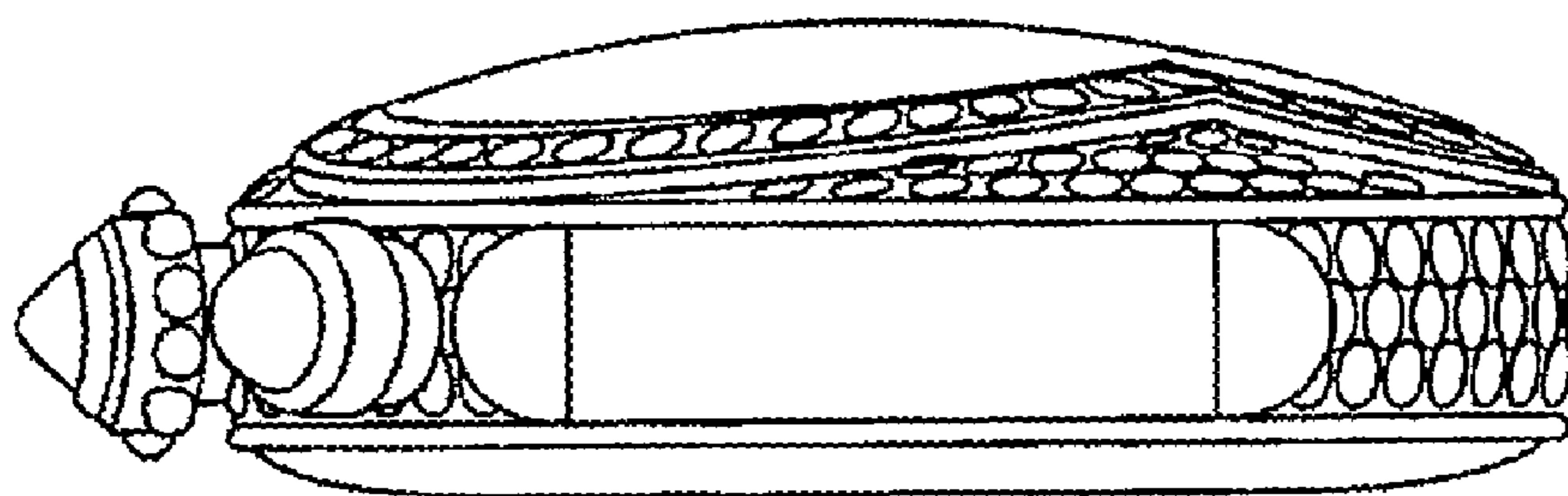

FIG. 5

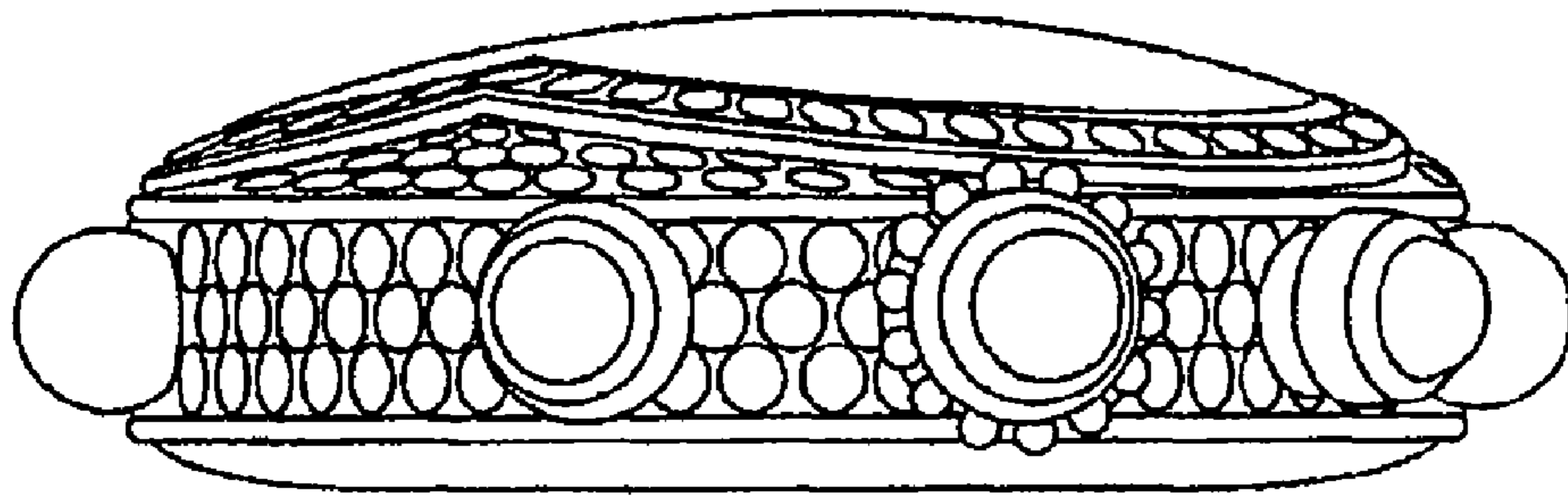

FIG. 6

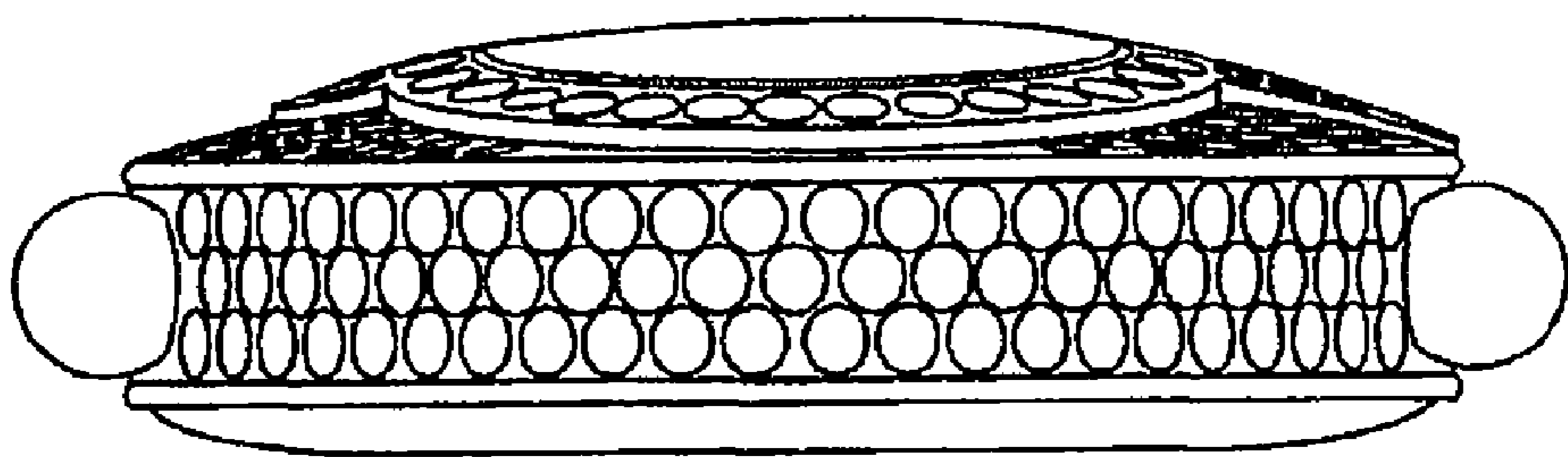

FIG. 7