



US00D564904S

(12) **United States Design Patent**
Leung

(10) **Patent No.:** **US D564,904 S**
(45) **Date of Patent:** **** Mar. 25, 2008**

(54) **COMBINED USB MEMORY DEVICE AND WATCH**

2007/0064542 A1* 3/2007 Fukushima 368/282

FOREIGN PATENT DOCUMENTS

(75) Inventor: **Chun Fai Leung**, Kowloon (HK)

JP 2002197421 A * 7/2002

(73) Assignee: **P.S.L.Limited**, Hong Kong (HK)

JP 2003140771 A * 5/2003

WO WO 2004/100059 A2 * 11/2004

(**) Term: **14 Years**

OTHER PUBLICATIONS

(21) Appl. No.: **29/277,452**

Cyberguys, Winter-Spring 2005, p. 148, Flash Media USB watch, [retrieved Jul. 25, 2007]. Retrieved from internet using Google advanced catalog search, URL:<www.cyberguys.com>.*

(22) Filed: **Feb. 27, 2007**

* cited by examiner

(30) **Foreign Application Priority Data**

Primary Examiner—Lucy Lieberman

Aug. 31, 2006 (HK) 0602269.7M004

(57) **CLAIM**

(51) **LOC (8) Cl.** **10-02**

(52) **U.S. Cl.** **D10/31**

(58) **Field of Classification Search** D10/30,
D10/31, 32, 38, 39, 122–132; 368/276, 277,
368/281, 282, 285, 239–242, 82–84, 28–30;
224/164; D14/435, 436

The ornamental design for a combined USB memory device and watch, as shown and described.

See application file for complete search history.

DESCRIPTION

(56) **References Cited**

The claimed combined USB memory device and watch is a small, portable timepiece with data-storage function.

U.S. PATENT DOCUMENTS

FIG. 1 is a front elevational view of a combined USB memory device and watch showing my new design;

4,432,655 A * 2/1984 Wollman 368/282

FIG. 2 is a rear elevational view thereof;

D331,021 S * 11/1992 Ishii et al. D10/31

FIG. 3 is a left side view thereof;

D382,211 S * 8/1997 Bodino D10/30

FIG. 4 is a right side view thereof;

D460,453 S * 7/2002 Homma et al. D14/435

FIG. 5 is a top plan view thereof;

D490,000 S * 5/2004 Lassigne D10/32

FIG. 6 is a bottom plan view thereof; and,

D495,258 S * 8/2004 Jorgensen D10/32

FIG. 7 is an exploded perspective view showing the combined USB memory device and watch separated from the watch. The watchband in FIG. 7 is shown in a fastened position.

D506,684 S * 6/2005 Junod D10/30

D511,519 S * 11/2005 Bone et al. D14/432

D525,977 S * 8/2006 Yao D14/436

D542,787 S * 5/2007 Siu D14/356

D545,220 S * 6/2007 Leung D10/31

2004/0001392 A1* 1/2004 Chung 368/278

2004/0233786 A1* 11/2004 Ting 368/2

1 Claim, 4 Drawing Sheets

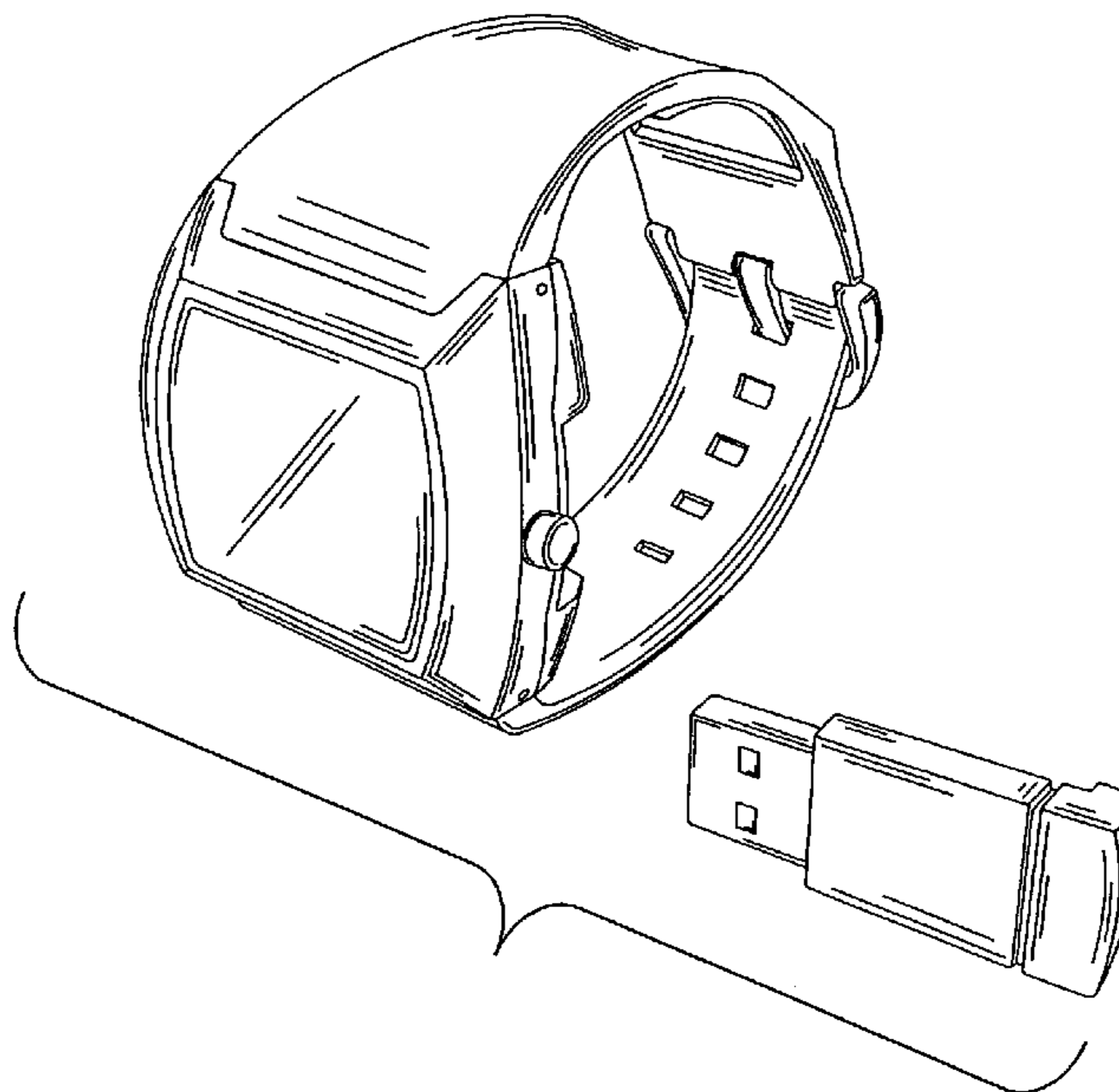

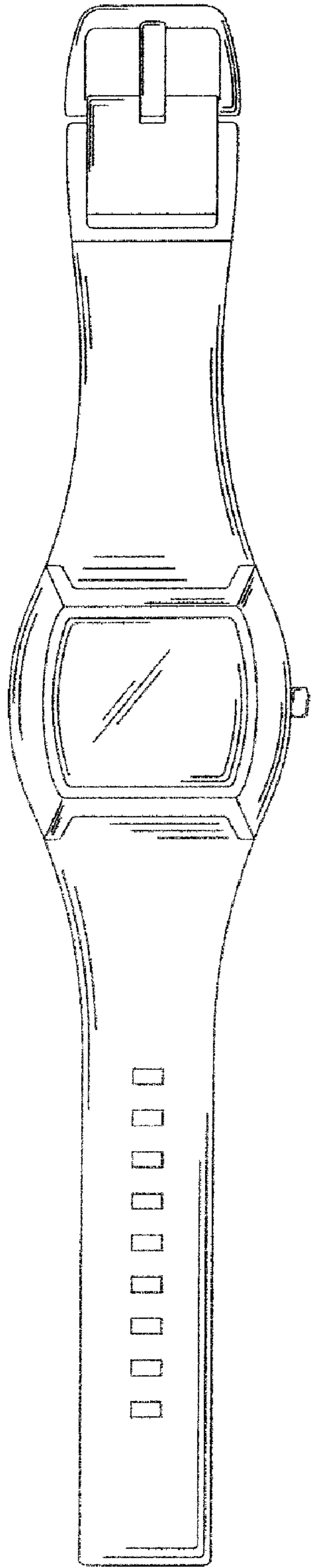

FIG. 1

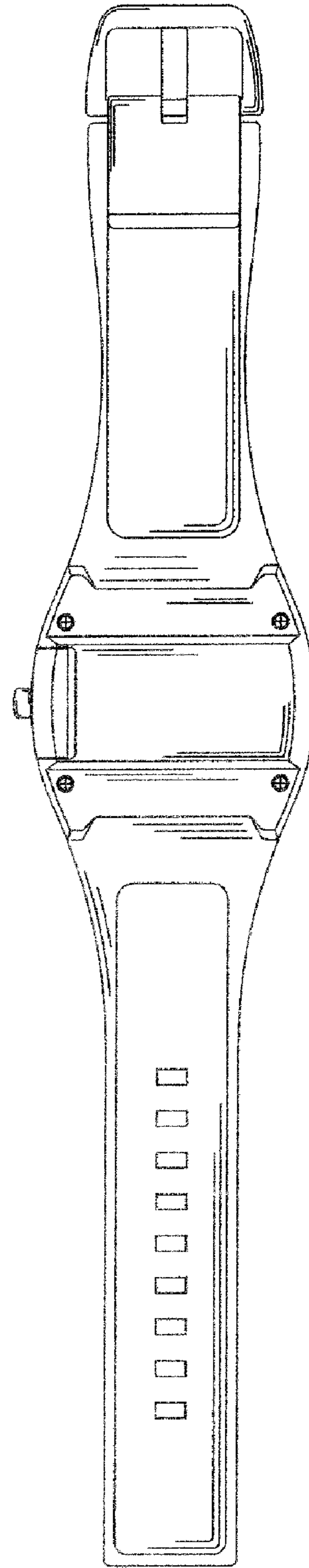

FIG. 2

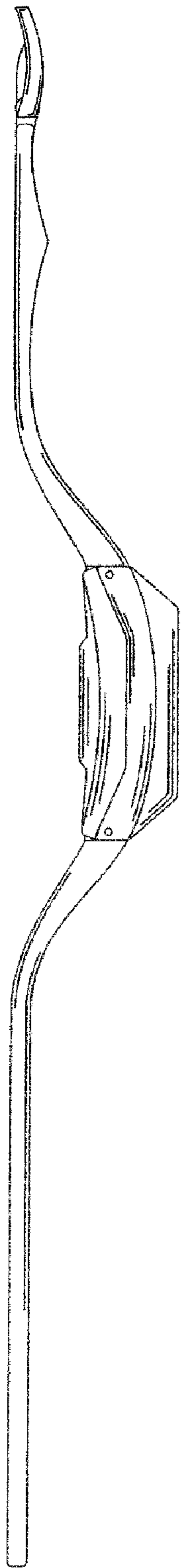

FIG. 3

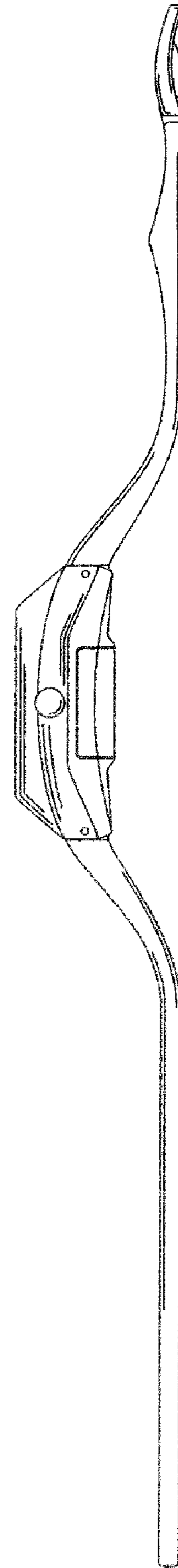

FIG. 4

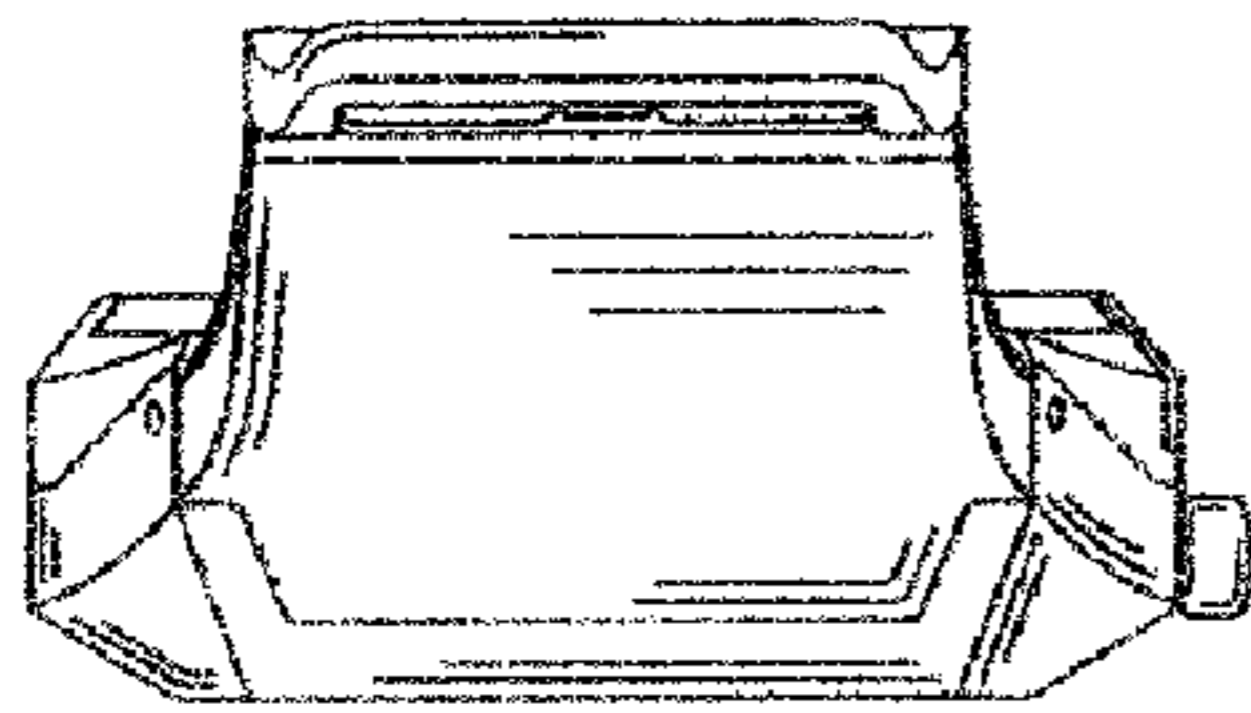

FIG. 5

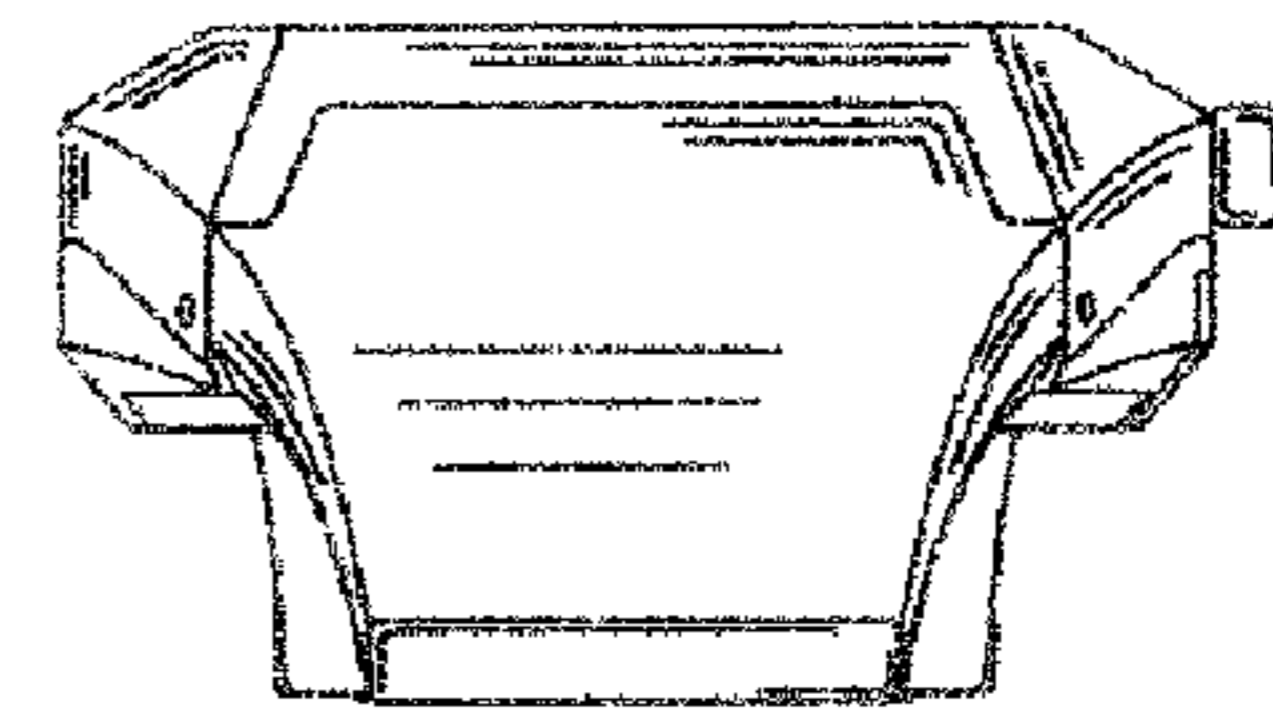

FIG. 6

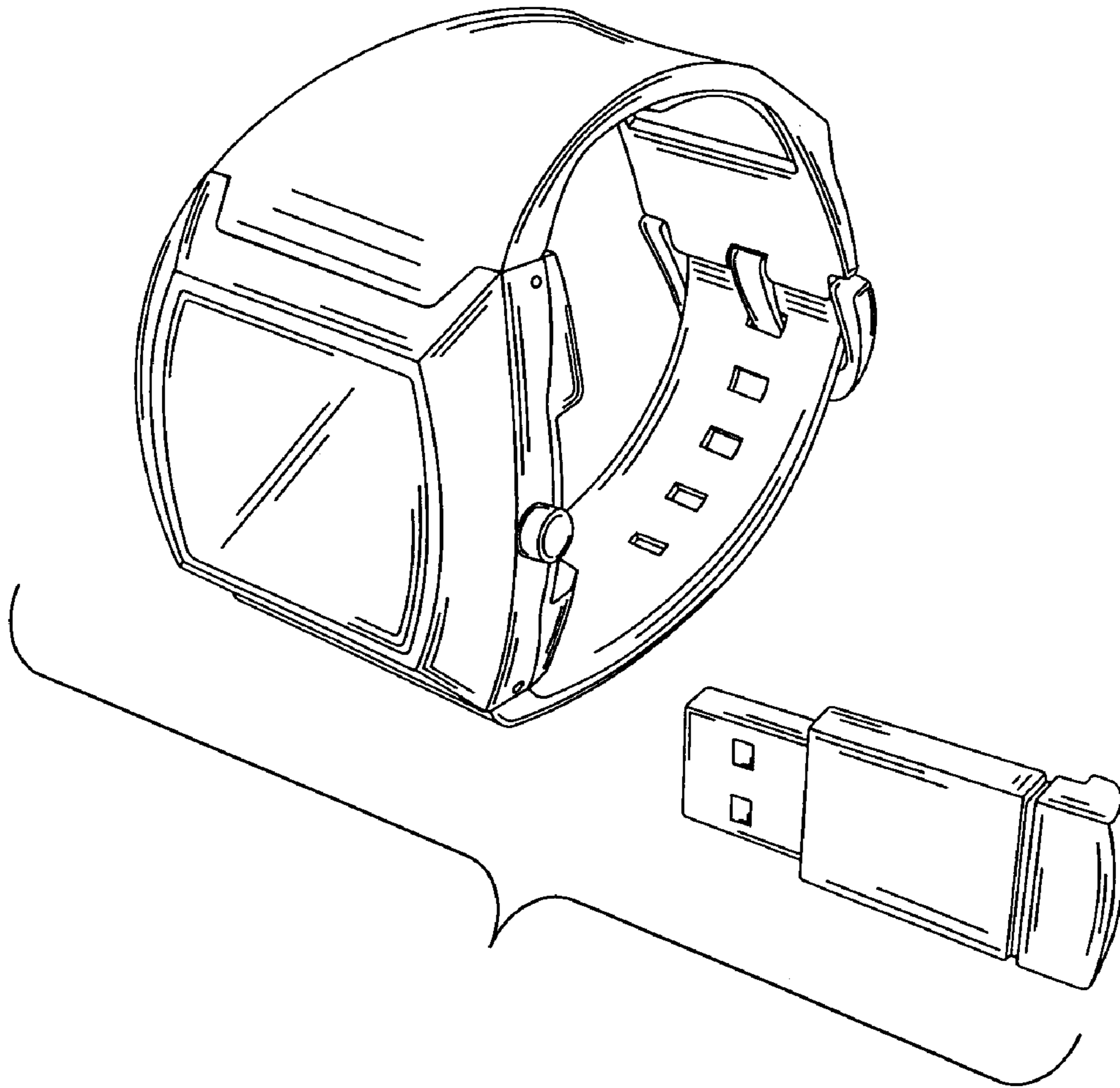

FIG. 7