



US00D564899S

(12) **United States Design Patent**
Hardy

(10) **Patent No.:** **US D564,899 S**
(45) **Date of Patent:** **** *Mar. 25, 2008**

(54) **POUCH WITH CLEANING COMPOSITIONS**

(75) Inventor: **Paul Andrew Hardy**, Hexham (GB)

(73) Assignee: **The Procter & Gamble Company**,
Cincinnati, OH (US)

(*) Notice: This patent is subject to a terminal disclaimer.

(**) Term: **14 Years**

(21) Appl. No.: **29/219,764**

(22) Filed: **Dec. 21, 2004**

(51) **LOC (8) Cl.** **09-03**

(52) **U.S. Cl.** **D9/715**

(58) **Field of Classification Search** D9/702,
D9/707, 710, 711, 715, 720, 721, 722; D28/8.1;
510/147, 225-277, 294, 298, 439-442, 447-449;
D1/6, 7, 100-104, 106, 112, 120, 199
See application file for complete search history.

(56) **References Cited**

U.S. PATENT DOCUMENTS

- 3,502,487 A 3/1970 Byrd
- 3,585,982 A * 6/1971 Hollinshead 126/263.1
- 4,416,791 A 11/1983 Haq
- 4,776,455 A 10/1988 Anderson et al.
- 4,973,416 A 11/1990 Kennedy
- 5,132,036 A * 7/1992 Falou et al. 510/277
- 5,224,601 A 7/1993 Gouge et al.
- D343,573 S 1/1994 Shadrach et al.
- D360,577 S * 7/1995 van Loo D9/707
- D445,673 S 7/2001 Richardson
- D445,675 S 7/2001 Richardson
- D451,795 S * 12/2001 Ghatlia et al. D9/710
- D452,143 S * 12/2001 Ghatlia et al. D28/8.1
- D452,754 S 1/2002 Neergaard
- 6,378,274 B1 4/2002 Harbour
- 6,403,543 B1 6/2002 George
- 6,465,413 B1 10/2002 Hinton
- D468,861 S 1/2003 Kosub
- D472,799 S * 4/2003 Ghatlia et al. D9/715

- D474,857 S 5/2003 McLeish
- 6,605,578 B1 8/2003 Fleckenstein et al.
- D479,123 S * 9/2003 Ghatlia et al. D9/715
- D479,128 S 9/2003 Jowett
- D494,317 S * 8/2004 Jowett et al. D28/8.1
- D505,081 S * 5/2005 Risgalla D9/707
- D509,751 S * 9/2005 Risgalla D9/707
- D513,109 S * 12/2005 Boyd D1/199
- D513,825 S * 1/2006 Boyd D1/199
- D518,917 S * 4/2006 Jowett et al. D28/8.1
- 2002/0033004 A1 3/2002 Edwards et al.
- 2002/0086806 A1 7/2002 Giblin et al.

FOREIGN PATENT DOCUMENTS

- GB 2102827 7/2001
- GB 2102830 7/2001
- GB 2106924 8/2002
- GB 3002437 9/2002
- GB 3009976 1/2004
- WO WO 97/01625 1/1997
- WO WO 98/30670 A2 7/1998
- WO WO 00/55068 A1 9/2000
- WO WO 02/16207 A1 2/2002
- WO WO 02/085736 A1 10/2002
- WO WO 02/085738 A1 10/2002

OTHER PUBLICATIONS

- The Procter & Gamble Company, Trademark Application No. 001917483, Danièle Le Carval Filed Oct. 19, 2000.
- The Procter & Gamble Company, Trademark Application No. 002040897, Danièle Le Carval Filed Jan. 15, 2001.
- Karl-Ludwig Gibis, Registered Community Design, 000070545-0001, Dec. 9, 2003, Reckitt Benckiser, (UK) Ltd.
- Michaela Marianne Murning, Registered Community Design, 000071725-0001, Dec. 9, 2003, Reckitt Benckiser, (UK) Ltd.
- Michaela Marianne Murning, Registered Community Design, 000071725-0002, Dec. 9, 2003, Reckitt Benckiser, (UK) Ltd.
- Michaela Marianne Murning, Registered Community Design, 000071725-0003, Dec. 9, 2003, Reckitt Benckiser, (UK) Ltd.
- Michaela Marianne Murning, Registered Community Design, 000071725-0004, Dec. 9, 2003, Reckitt Benckiser, (UK) Ltd.
- Michaela Marianne Murning, Registered Community Design, 000071725-0005, Dec. 9, 2003, Reckitt Benckiser, (UK) Ltd.
- Michaela Marianne Murning, Registered Community Design, 000071725-0006, Dec. 9, 2003, Reckitt Benckiser, (UK) Ltd.
- Michaela Marianne Murning, Registered Community Design, 000071725-0007, Dec. 9, 2003, Reckitt Benckiser, (UK) Ltd.

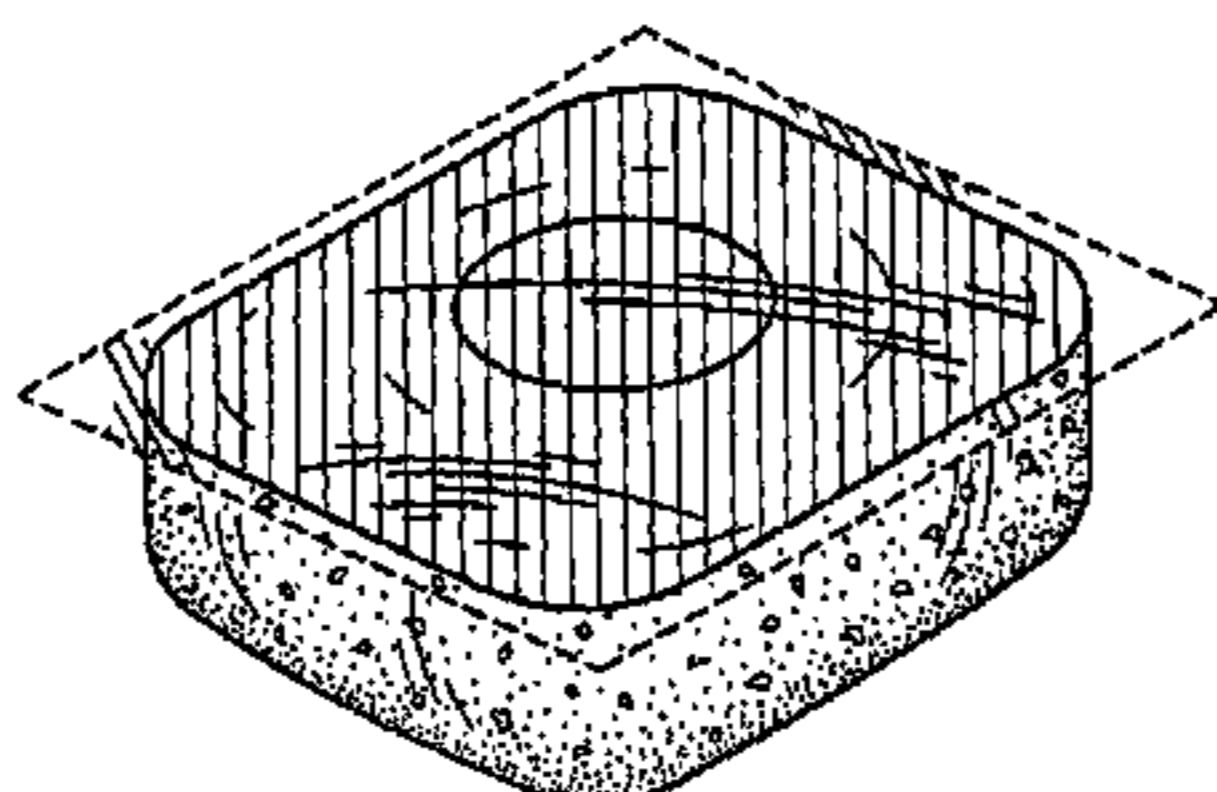
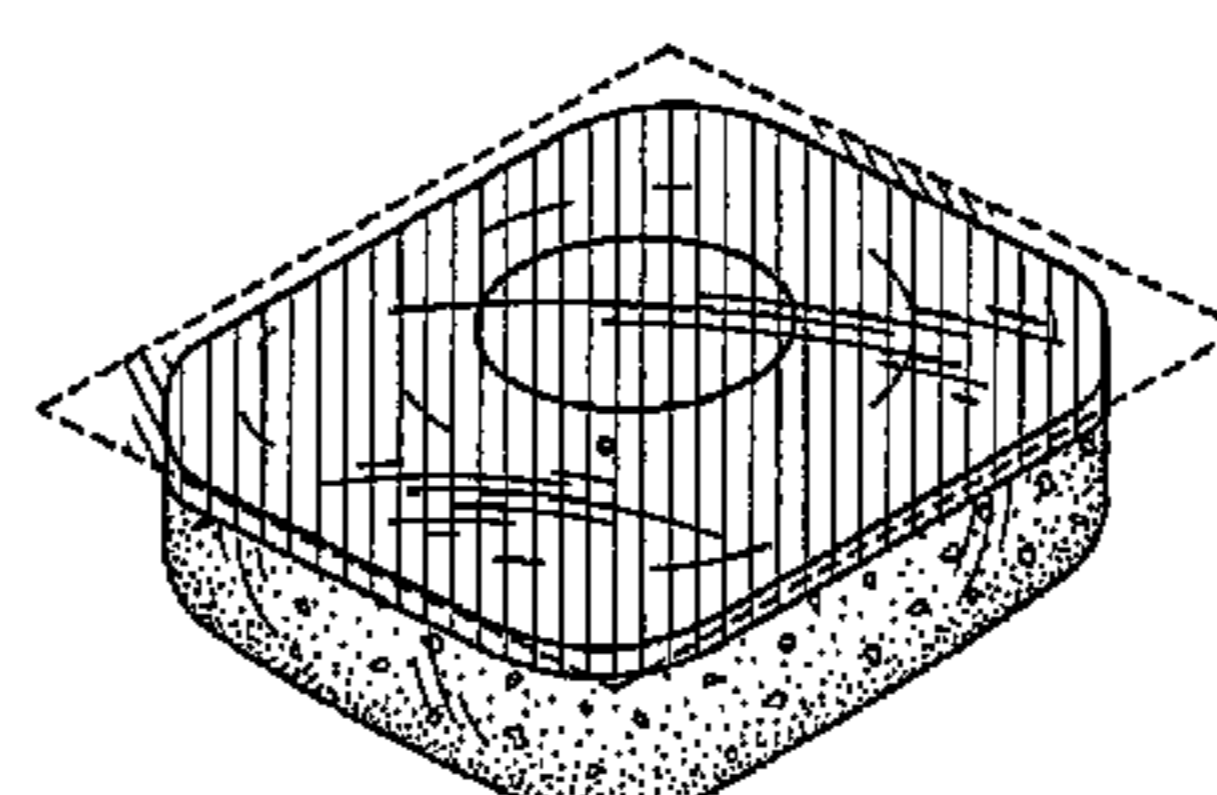
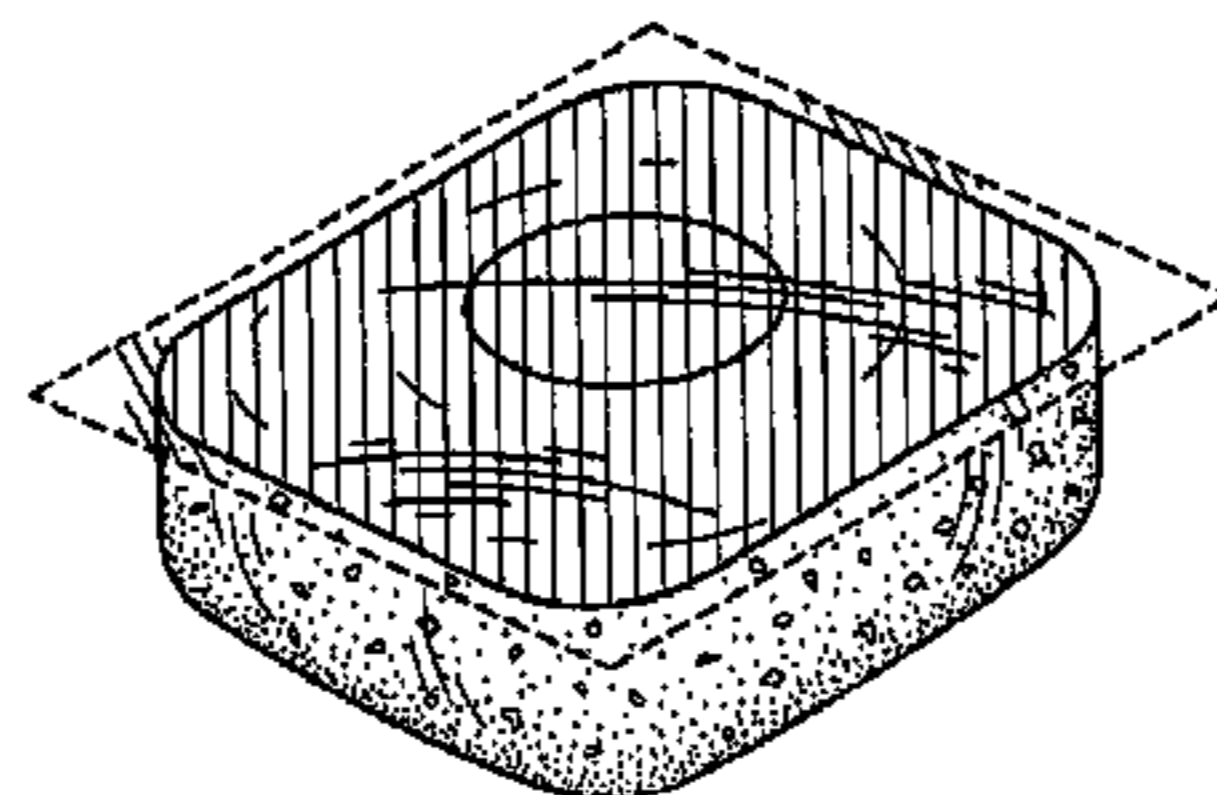

Michaela Marianne Murning, Registered Community Design, 000071725-0008, Dec. 9, 2003, Reckitt Benckiser, (UK) Ltd.
 Michaela Marianne Murning, Registered Community Design, 000071725-0009, Dec. 9, 2003, Reckitt Benckiser, (UK) Ltd.
 Michaela Marianne Murning, Registered Community Design, 000071725-0010, Dec. 9, 2003, Reckitt Benckiser, (UK) Ltd.
 Michaela Marianne Murning, Registered Community Design, 000071725-0011, Dec. 9, 2003, Reckitt Benckiser, (UK) Ltd.
 Michaela Marianne Murning, Registered Community Design, 000071725-0012, Dec. 9, 2003, Reckitt Benckiser, (UK) Ltd.
 Michaela Marianne Murning, Registered Community Design, 000071725-0013, Dec. 9, 2003, Reckitt Benckiser, (UK) Ltd.
 Michaela Marianne Murning, Registered Community Design, 000071725-0014, Dec. 9, 2003, Reckitt Benckiser, (UK) Ltd.
 Nigel Sommer Ville-Roberts, Registered Community Design, 000068135-0001, Dec. 23, 2003, The Procter & Gamble Company, United States.
 Louise Margaret Jowett, Registered Community Design, 000078506-0001, Dec. 23, 2003, Reckitt Benckiser, (UK) Ltd.
 David Helps, Registered Community Design, 000131636-0006, May 4, 2004, Reckitt Benckiser, (UK) Ltd.
 Bruce McCarthy, Registered Community Design, 000152509-0001, Jun. 15, 2004, Reckitt Benckiser, (UK) Ltd.
 Bruce McCarthy, Registered Community Design, 000152509-0002, Jun. 15, 2004, Reckitt Benckiser, (UK) Ltd.
 Bruce McCarthy, Registered Community Design, 000152509-0003, Jun. 15, 2004, Reckitt Benckiser, (UK) Ltd.
 Bruce McCarthy, Registered Community Design, 000152509-0004, Jun. 15, 2004, Reckitt Benckiser, (UK) Ltd.
 Bruce McCarthy, Registered Community Design, 000152509-0005, Jun. 15, 2004, Reckitt Benckiser, (UK) Ltd.
 Bruce McCarthy, Registered Community Design, 000152509-0006, Jun. 15, 2004, Reckitt Benckiser, (UK) Ltd.
 Bruce McCarthy, Registered Community Design, 000152509-0007, Jun. 15, 2004, Reckitt Benckiser, (UK) Ltd.
 Bruce McCarthy, Registered Community Design, 000152509-0008, Jun. 15, 2004, Reckitt Benckiser, (UK) Ltd.
 Andrew Robert McLeish, Registered Community Design, 000156344-0001, Jun. 15, 2004, Reckitt Benckiser, (UK) Ltd.
 Andrew Robert McLeish, Registered Community Design, 000156344-0002, Jun. 15, 2004, Reckitt Benckiser, (UK) Ltd.
 Andrew Robert McLeish, Registered Community Design, 000156344-0003, Jun. 15, 2004, Reckitt Benckiser, (UK) Ltd.
 Bruce McCarthy, Registered Community Design, 000157417-0001, Jun. 29, 2004, Reckitt Benckiser, (UK) Ltd.
 U.S. Appl. No. 29/197,899, filed Jan. 22, 2004, Main, et al.
 U.S. Appl. No. 29/209,778, filed Jul. 21, 2004, Main, et al.
 U.S. Appl. No. 29/219,714, filed Dec. 21, 2004, Hardy.

* cited by examiner

Primary Examiner—Stella M. Reid
Assistant Examiner—Shanda C. Hill
 (74) *Attorney, Agent, or Firm*—Jeffrey V. Bamber; Laura R. Grunzinger

(57)

CLAIM

The ornamental design for a pouch with cleaning compositions, as shown and described.

DESCRIPTION

FIG. 1 is a perspective view of a pouch with cleaning compositions showing my new design;

FIG. 2 is a top view thereof;

FIG. 3 is a bottom view thereof;

FIG. 4 is a side elevational view thereof, the opposite side elevational view being the same;

FIG. 5 is an end view thereof, the opposite end view being the same;

FIG. 6 is a perspective view of a second embodiment of the pouch with cleaning compositions;

FIG. 7 is a top view thereof;

FIG. 8 is a bottom view thereof;

FIG. 9 is a side elevational view thereof, the opposite side elevational view being the same;

FIG. 10 is an end view thereof, the opposite end view being the same;

FIG. 11 is a perspective view of a third embodiment of the pouch with cleaning compositions;

FIG. 12 is a top view thereof;

FIG. 13 is a side elevational view thereof, the opposite side elevational view being the same;

FIG. 14 is a side elevational view thereof, the opposite side elevational view being the same;

FIG. 15 is a an end view thereof, the opposite end view being the same;

FIG. 16 is a perspective view of a fourth embodiment of the pouch with cleaning compositions;

FIG. 17 is a top view thereof;

FIG. 18 is a bottom view thereof;

FIG. 19 is a side elevational view thereof, the opposite side elevational view being the same; and,

FIG. 20 is an end view thereof, the opposite end view being the same.

The broken lines shown in the drawings are for illustrative purposes only and form no part of the claimed design.

1 Claim, 8 Drawing Sheets

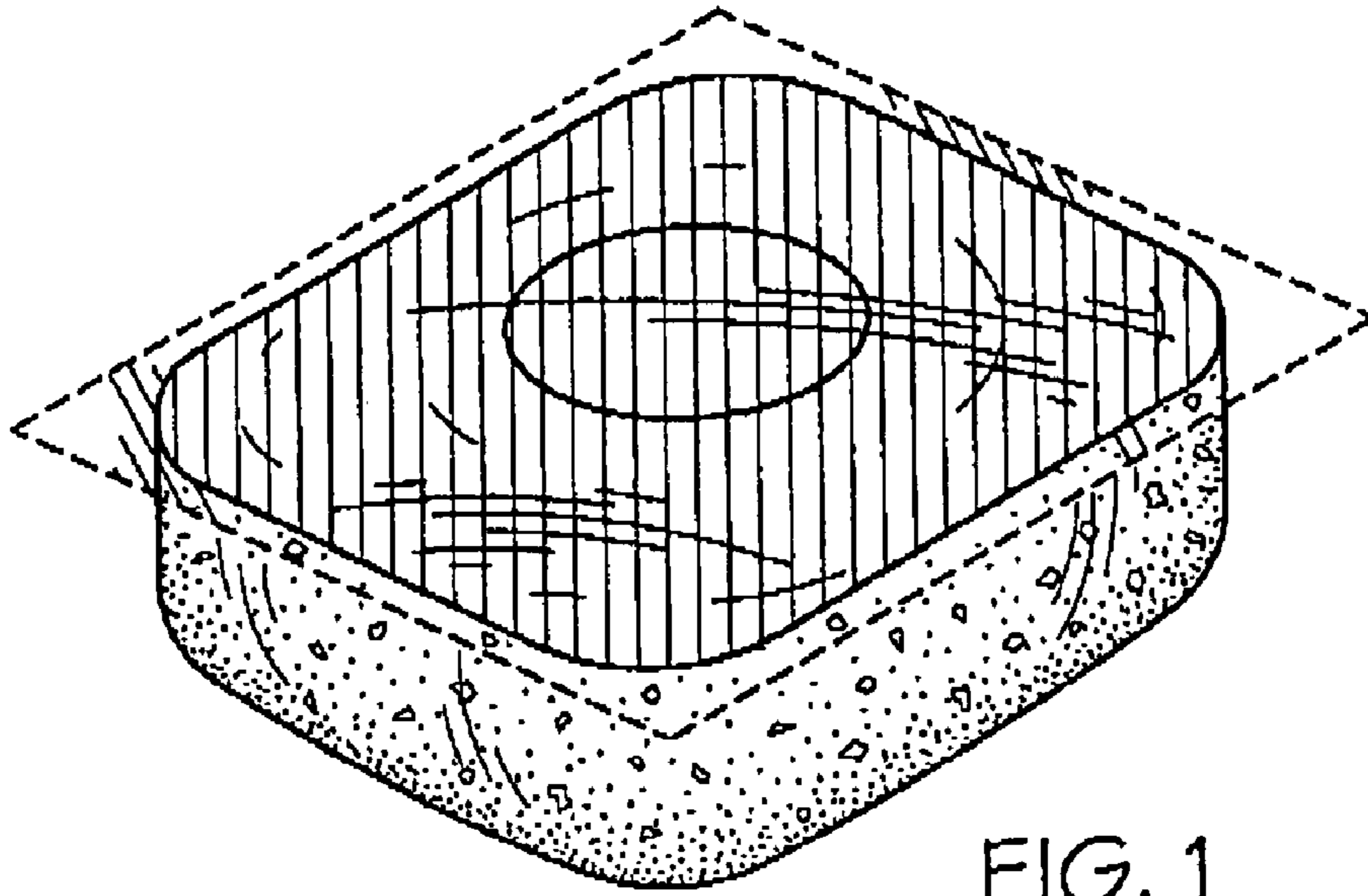

FIG. 1

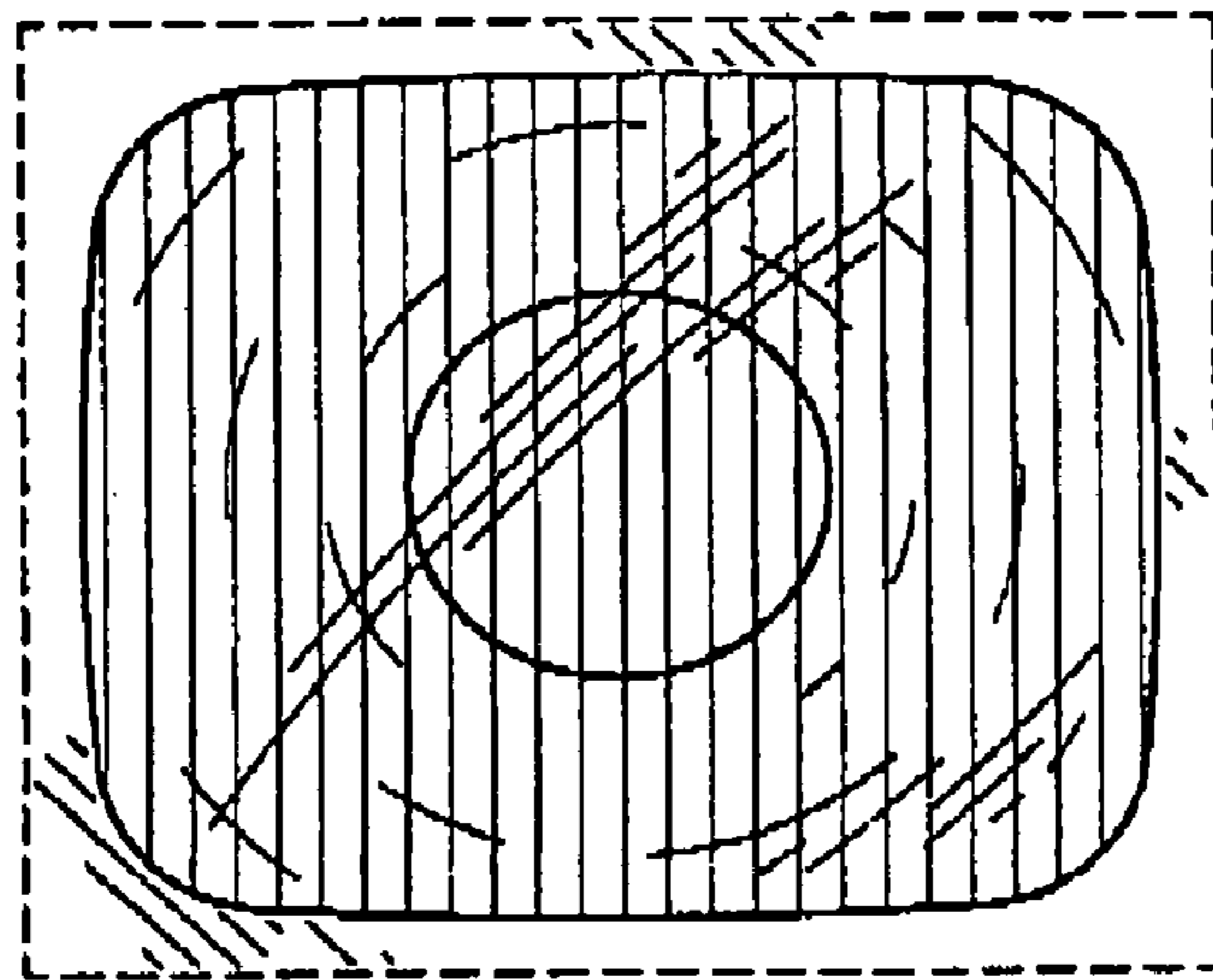

FIG. 2

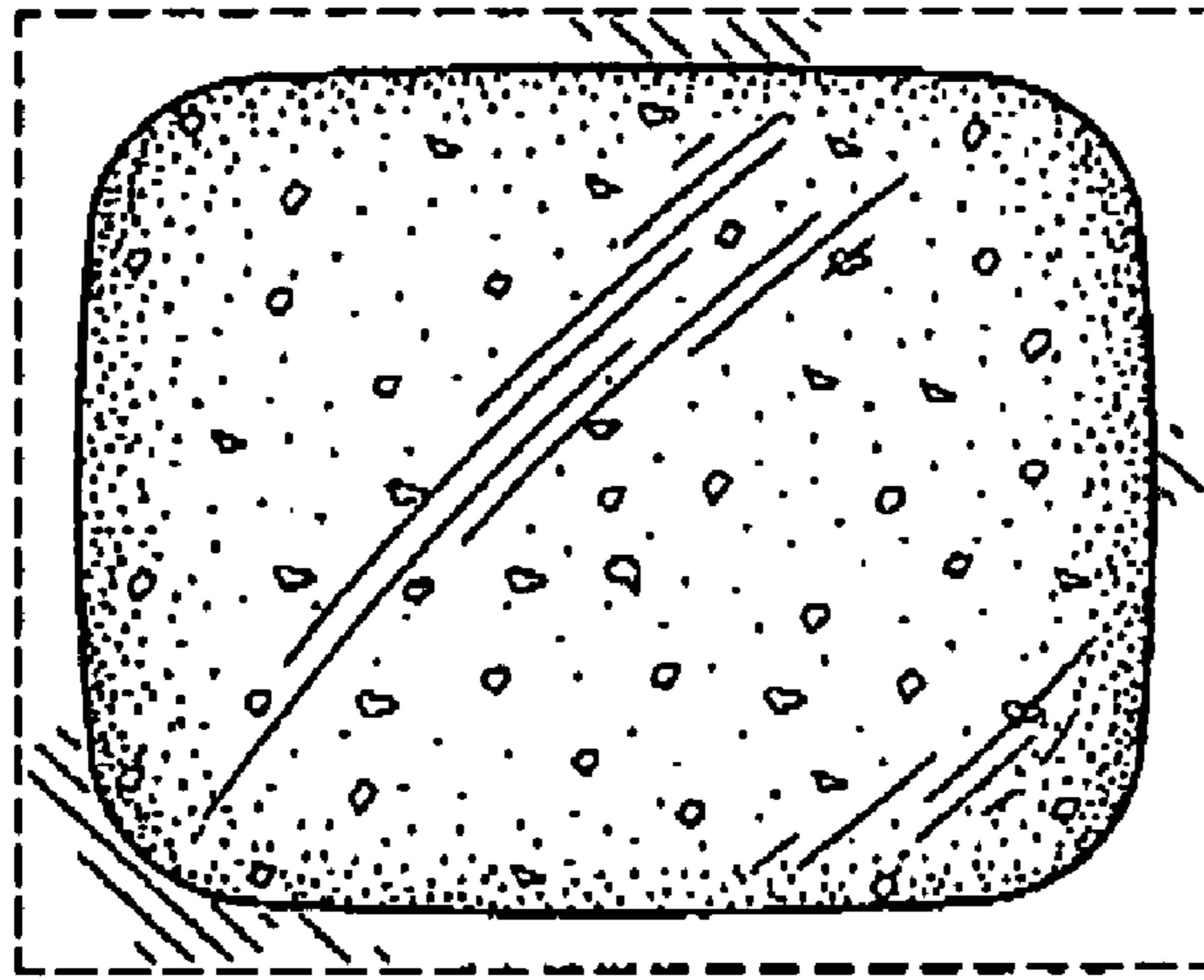

FIG. 3

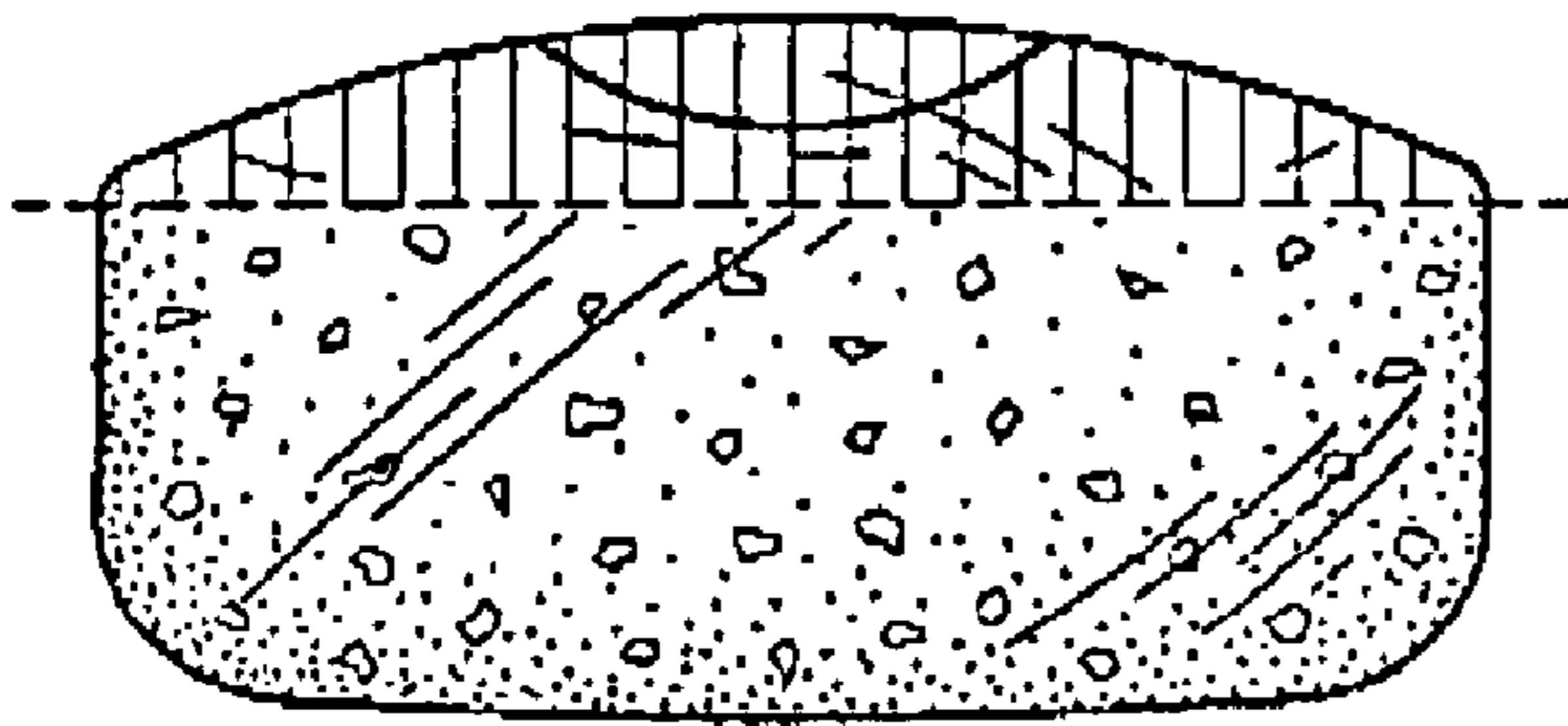

FIG. 4

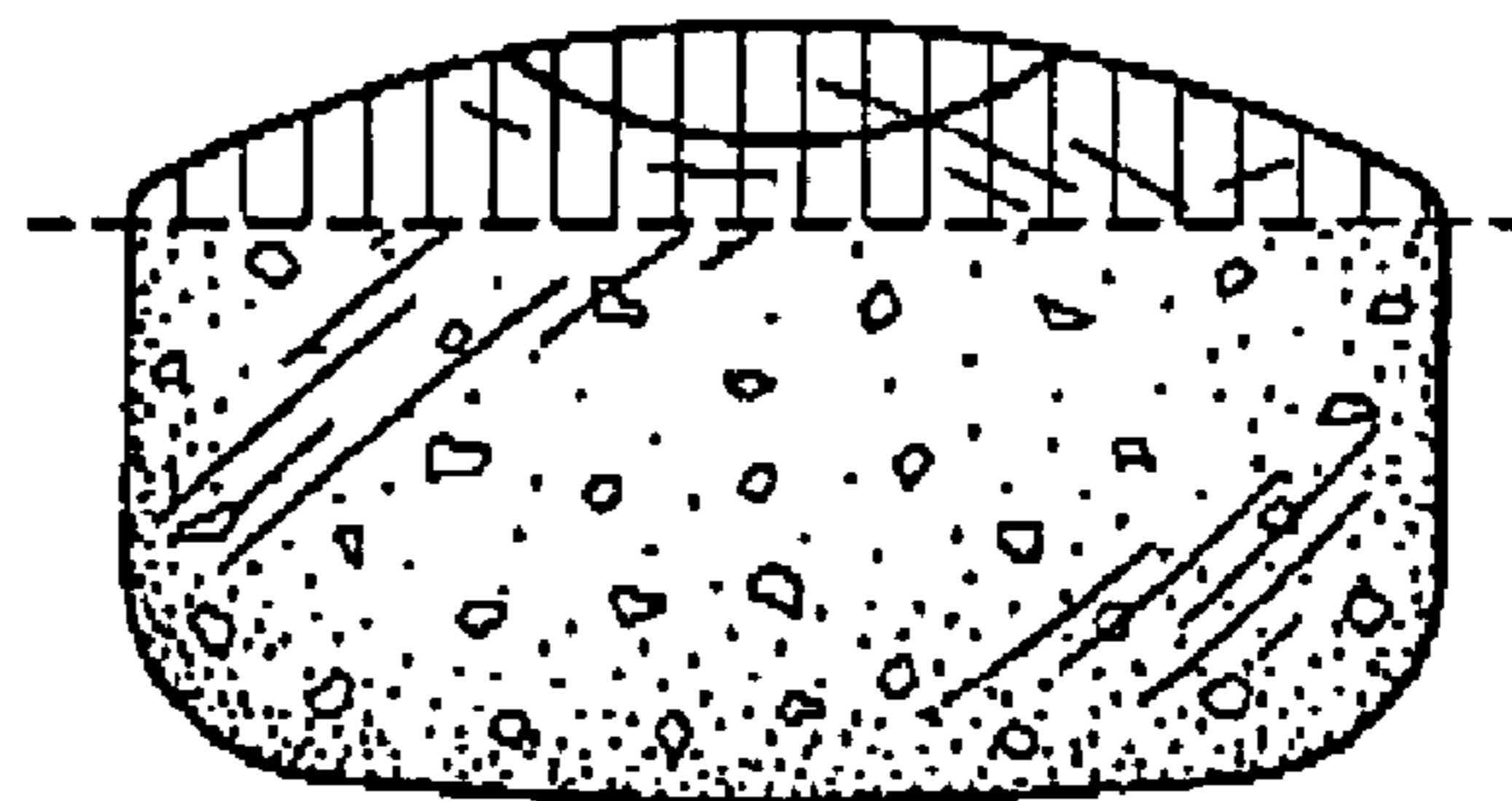

FIG. 5

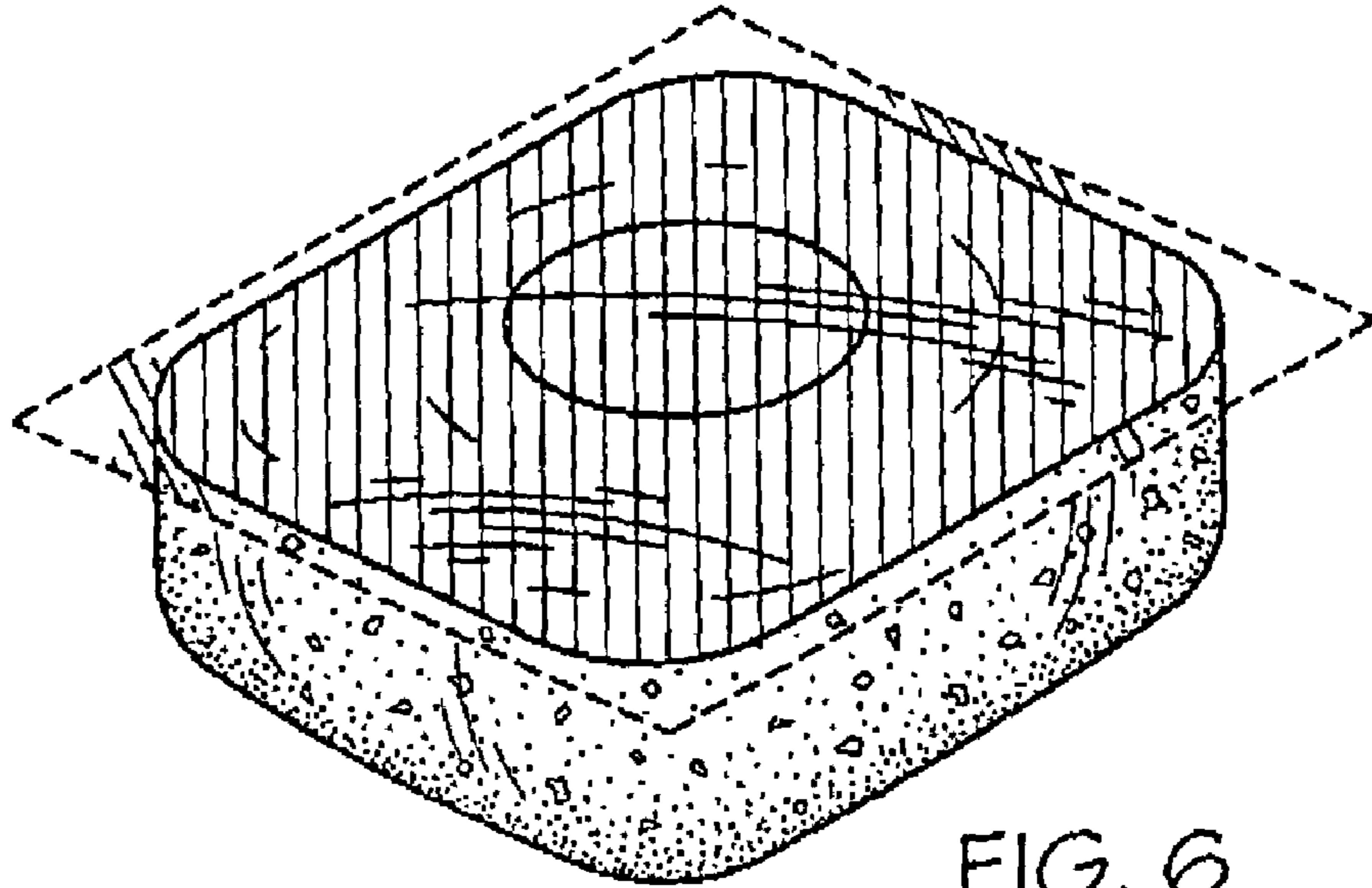

FIG. 6

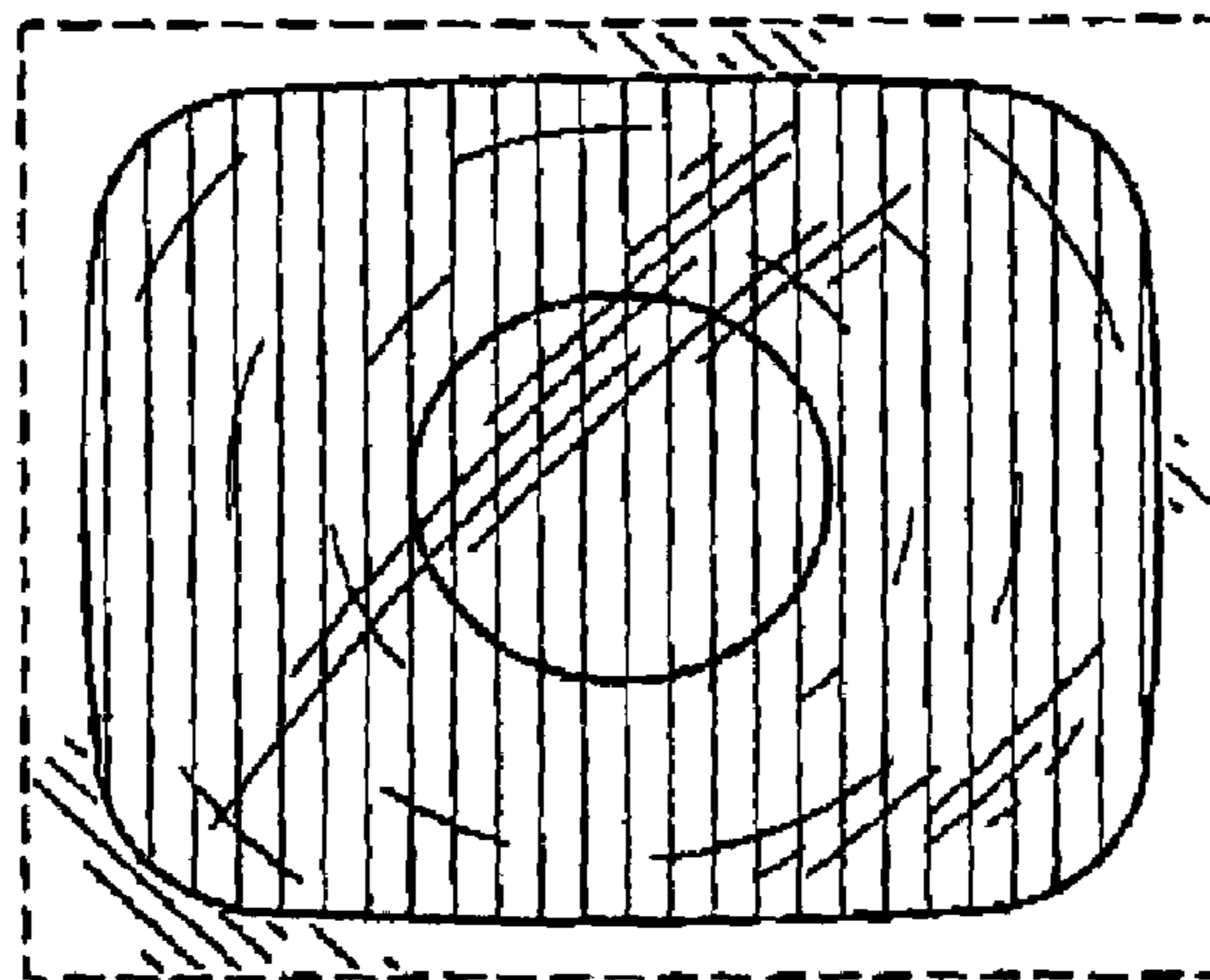

FIG. 7

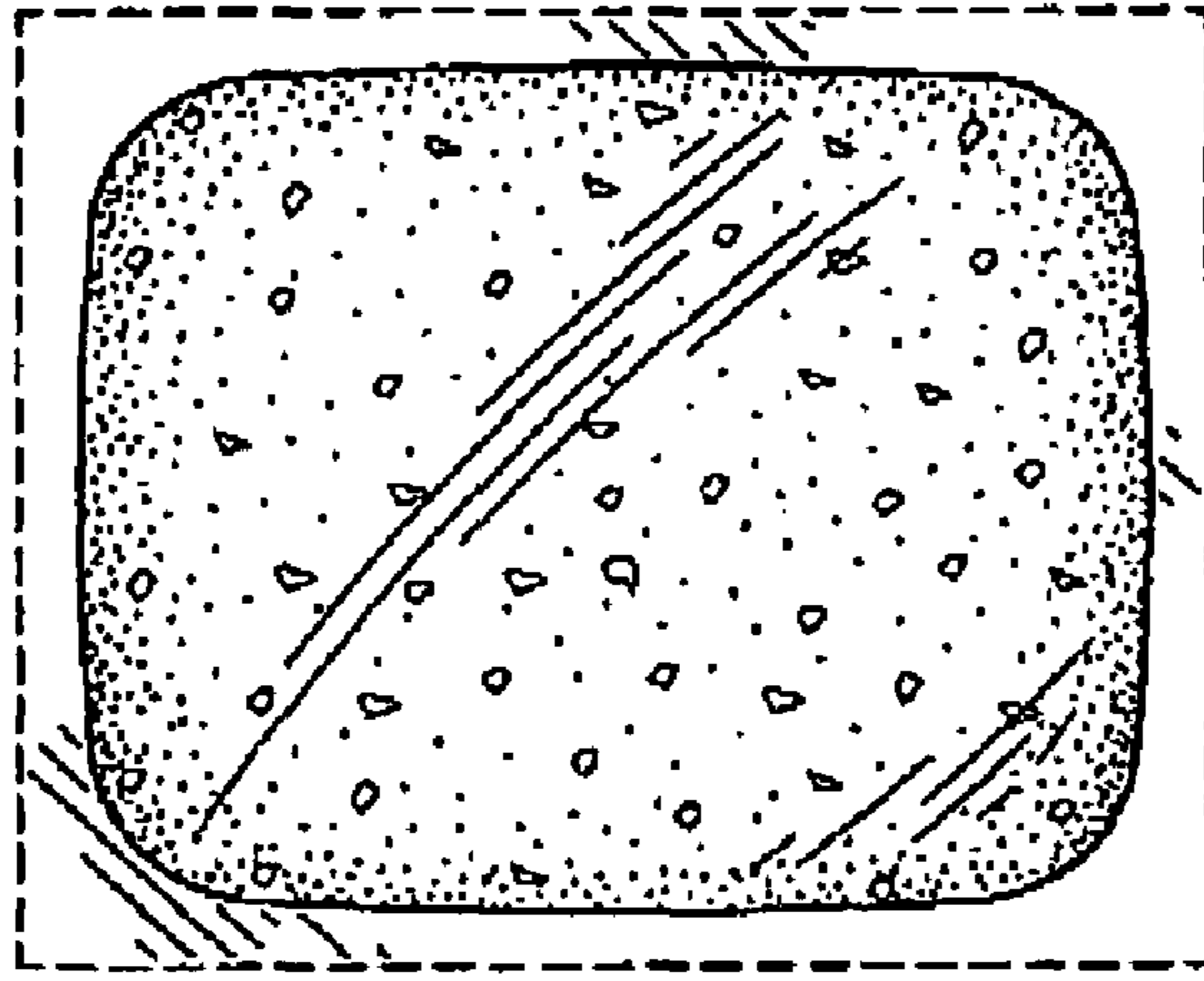

FIG. 8

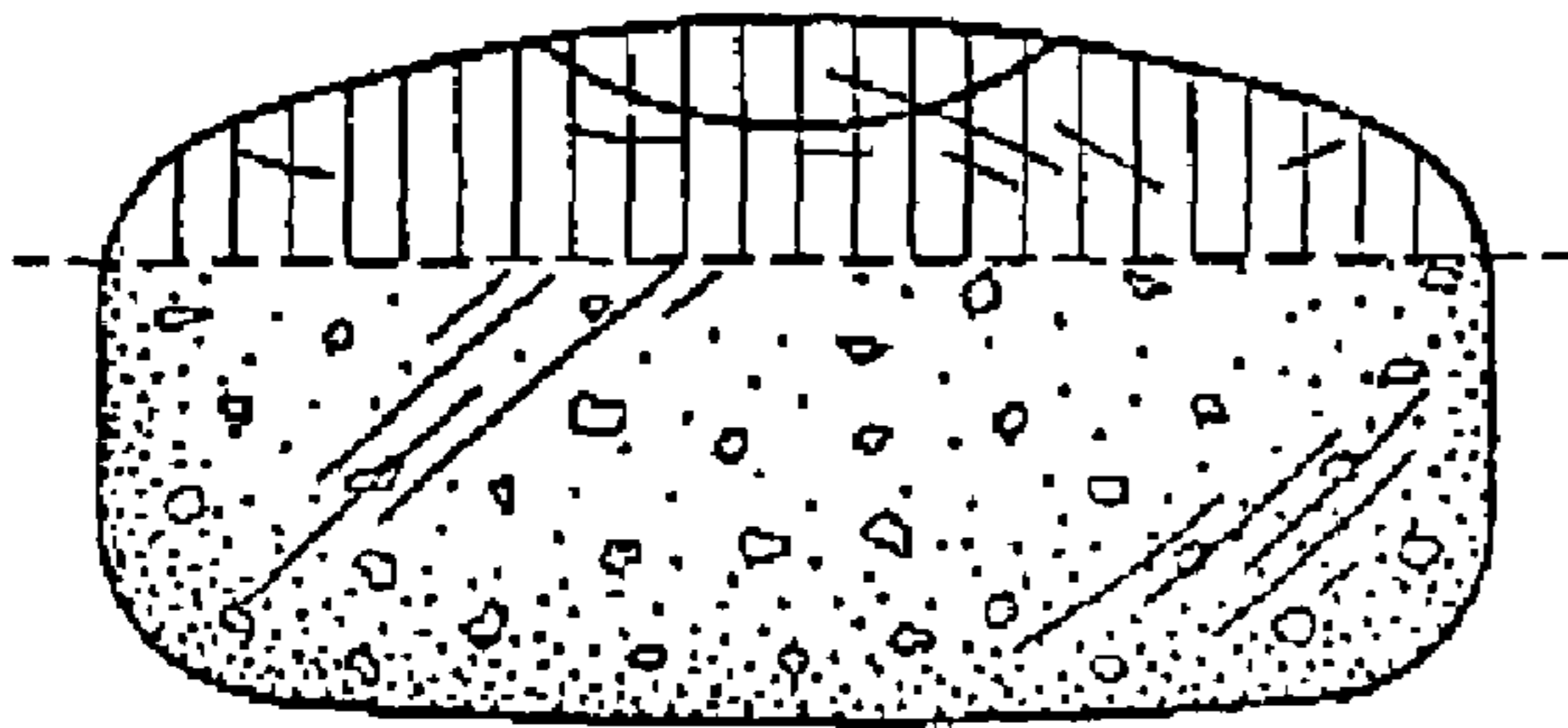

FIG. 9

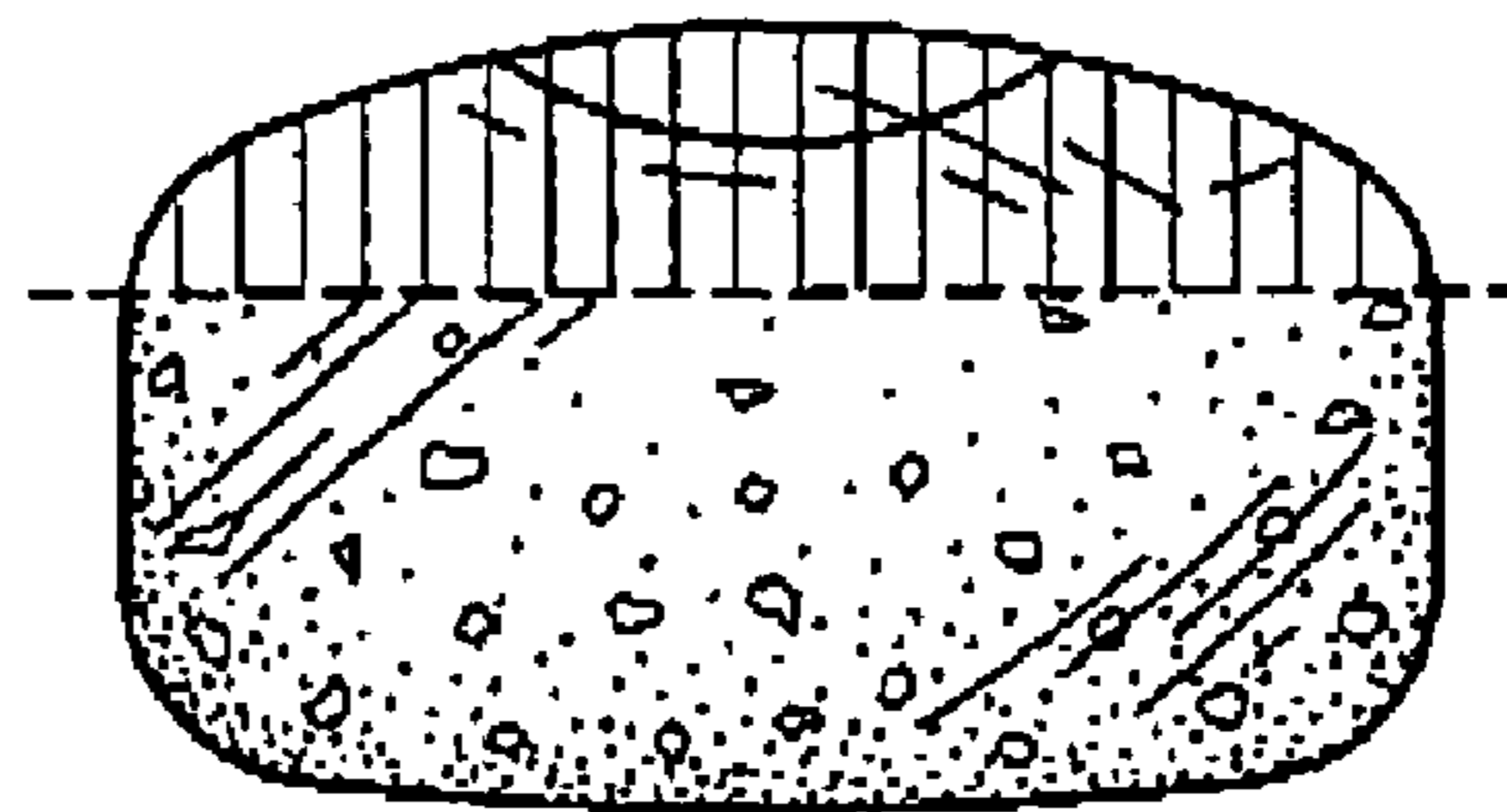

FIG. 10

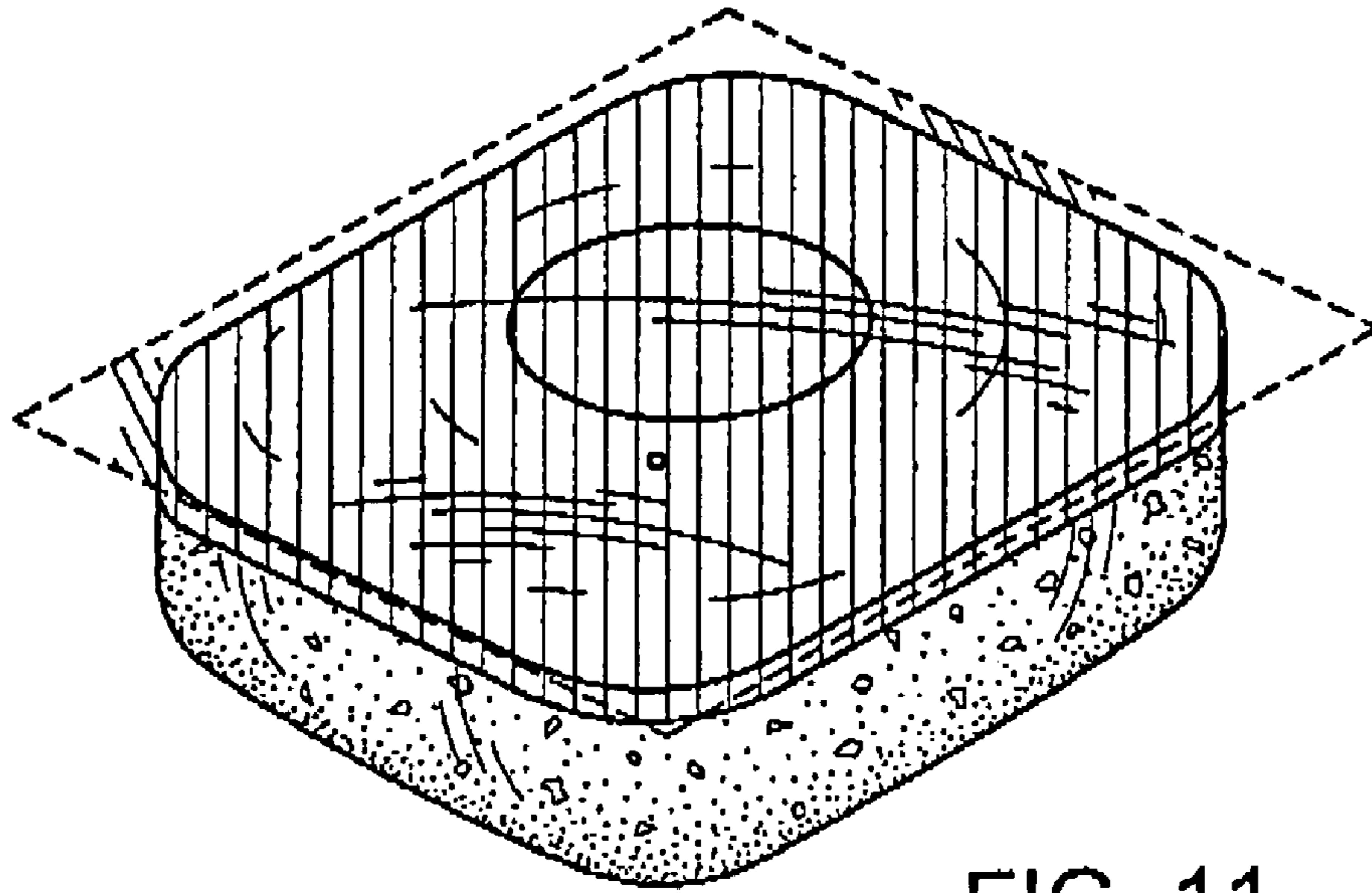

FIG. 11

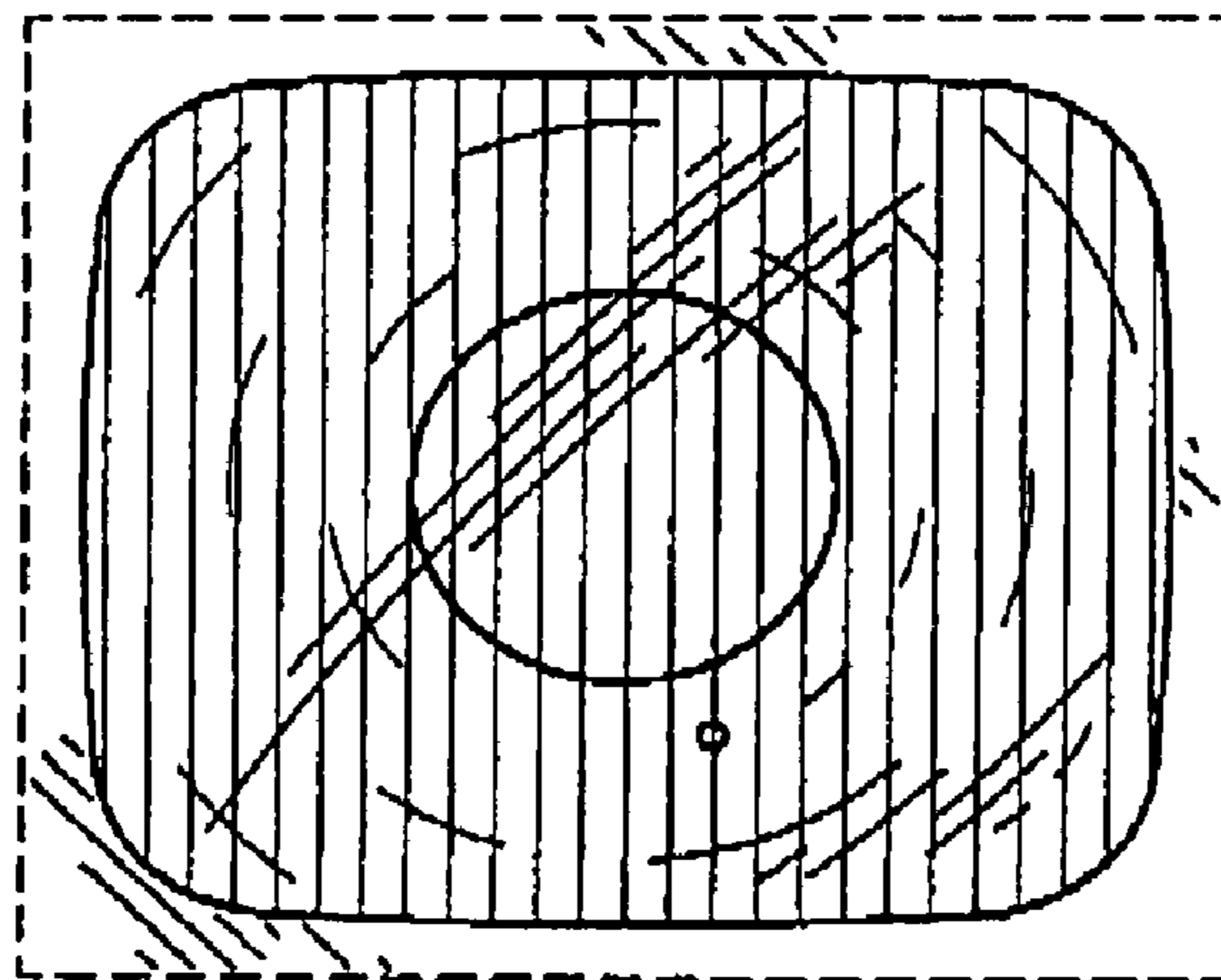

FIG. 12

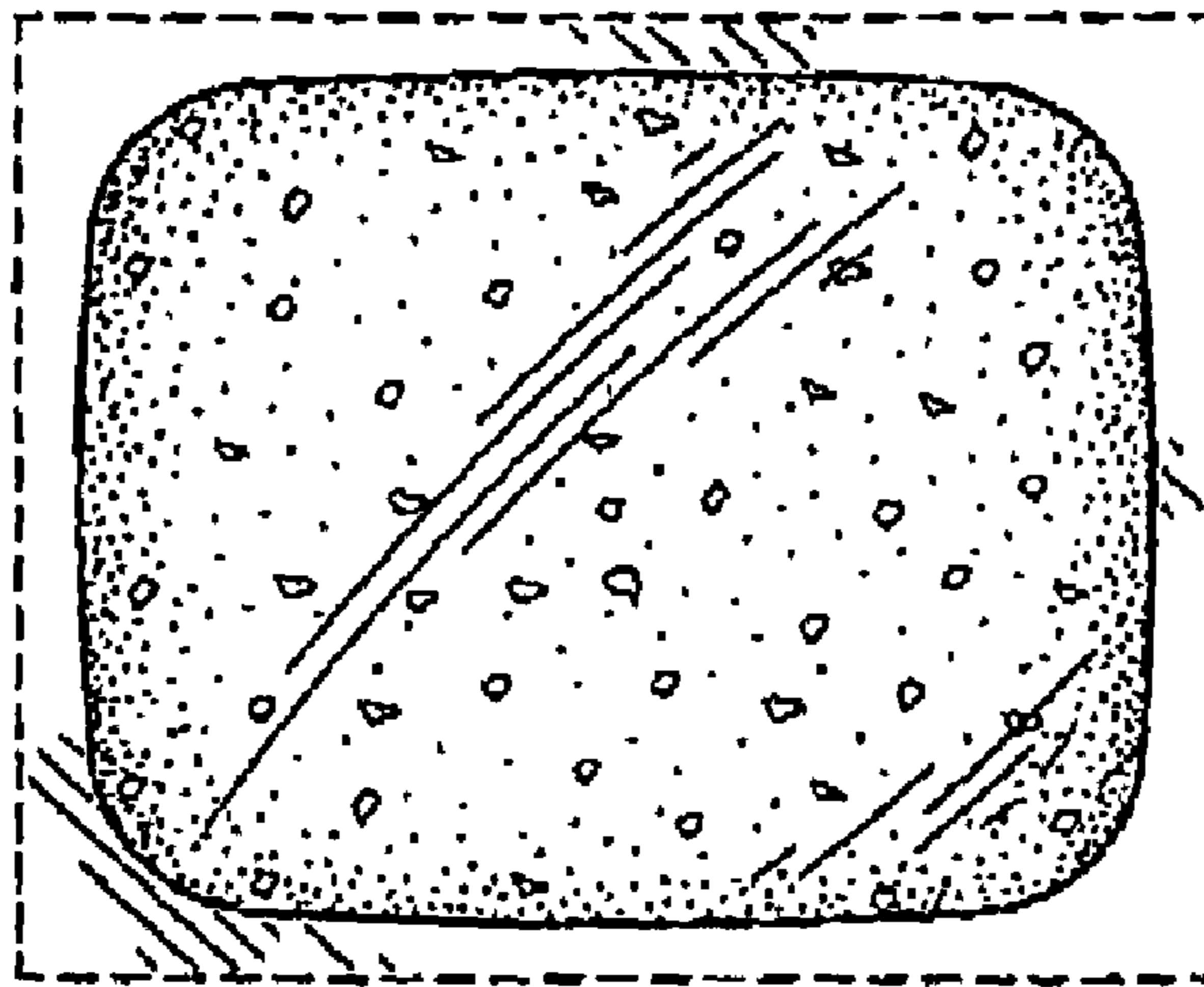

FIG. 13

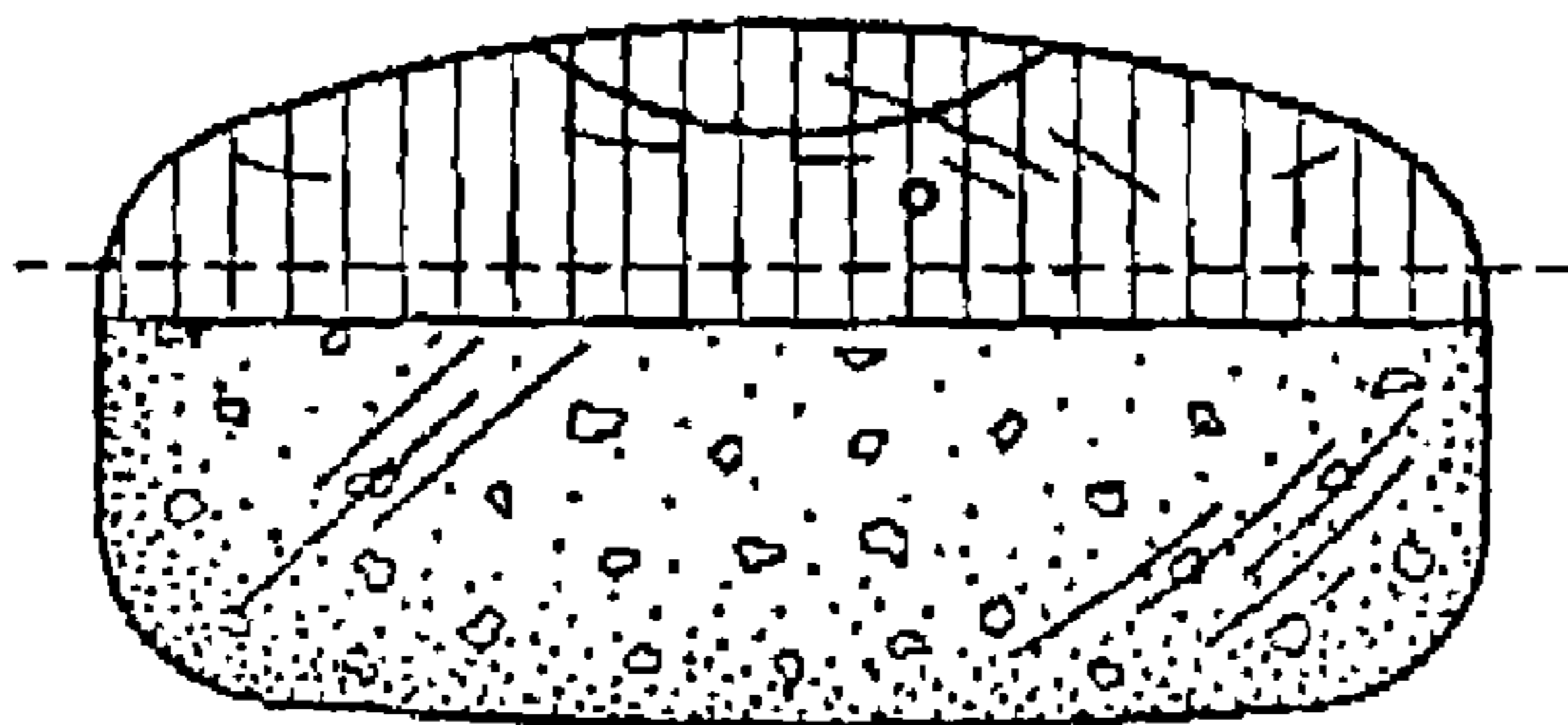

FIG. 14

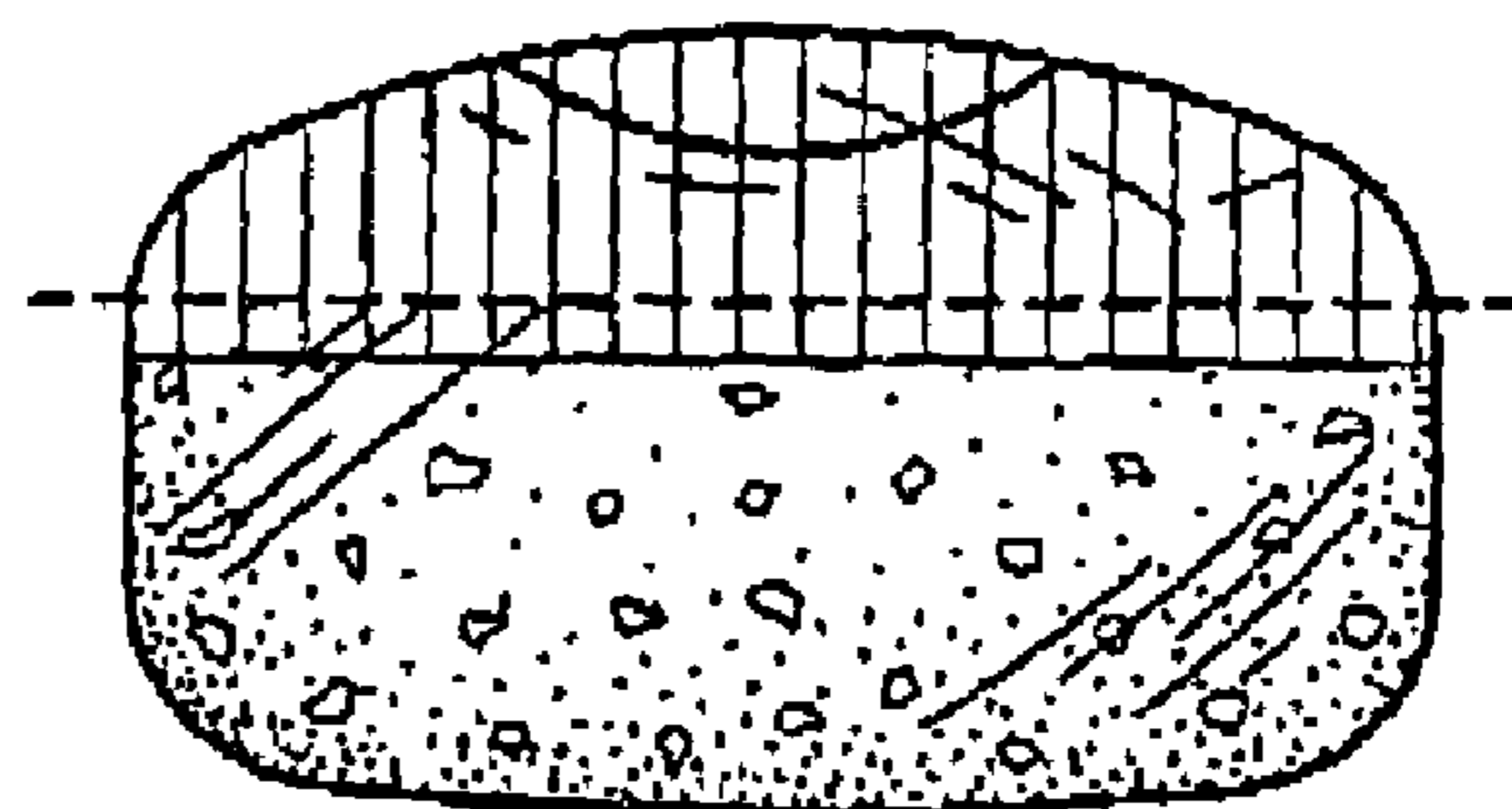

FIG. 15

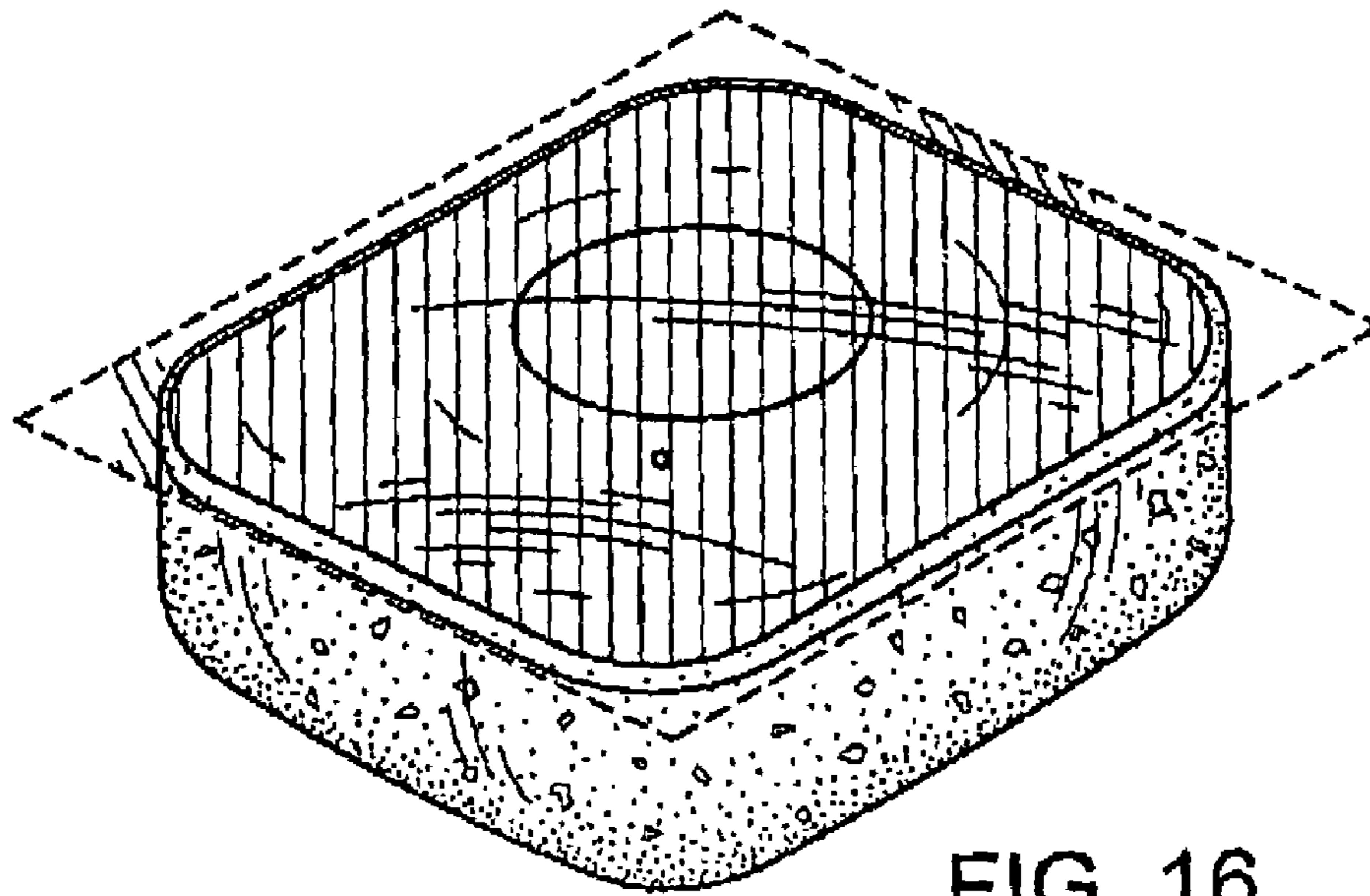

FIG. 16

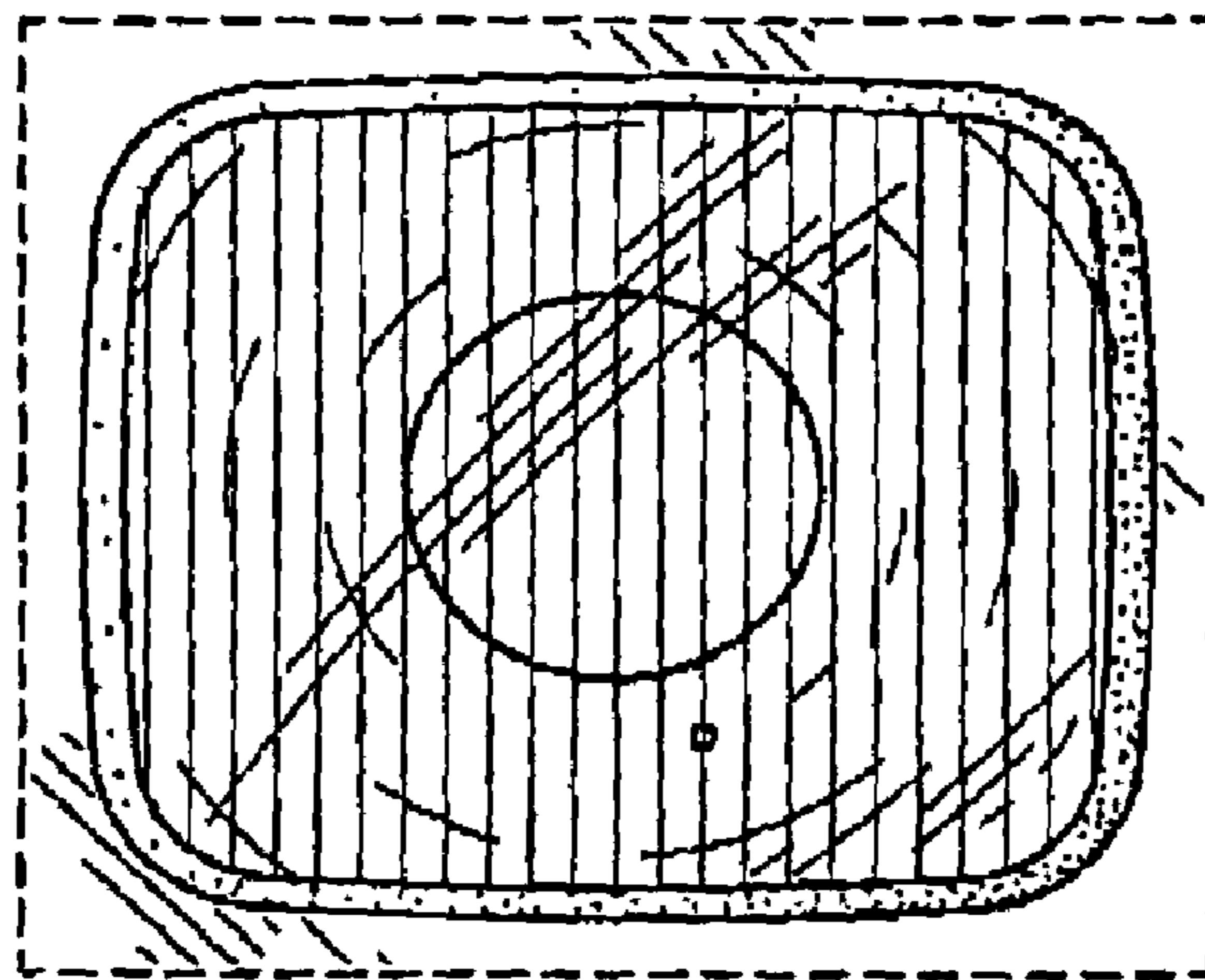

FIG. 17

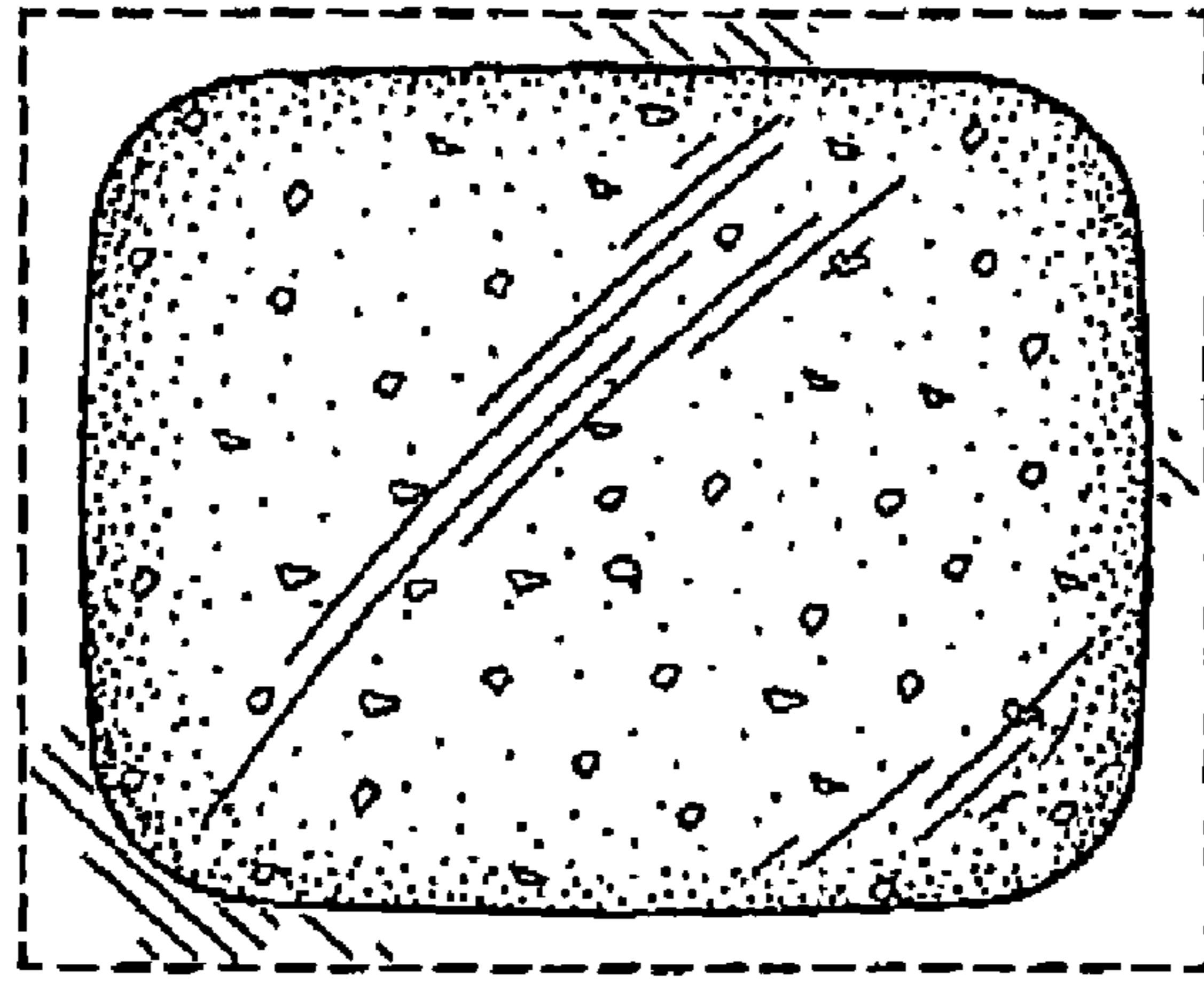

FIG. 18

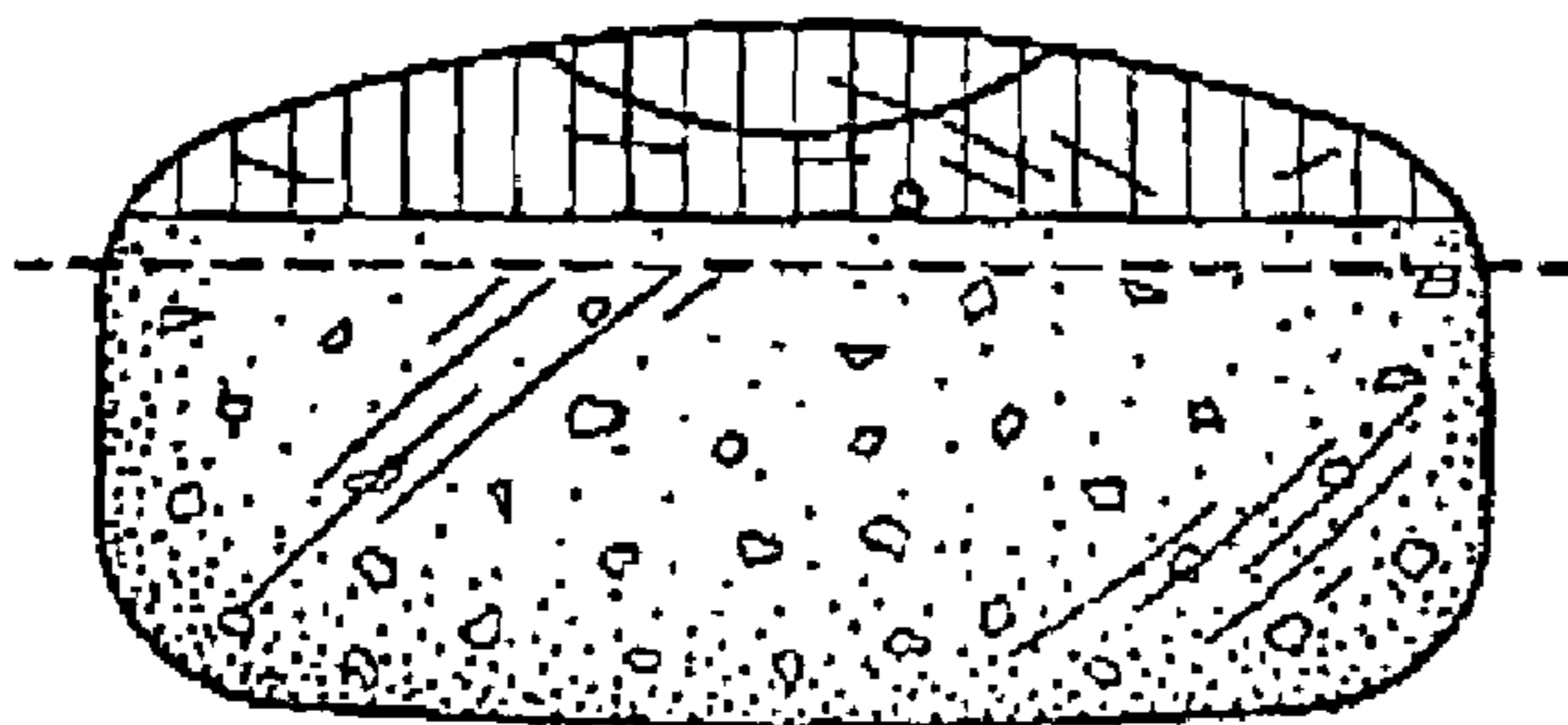

FIG. 19

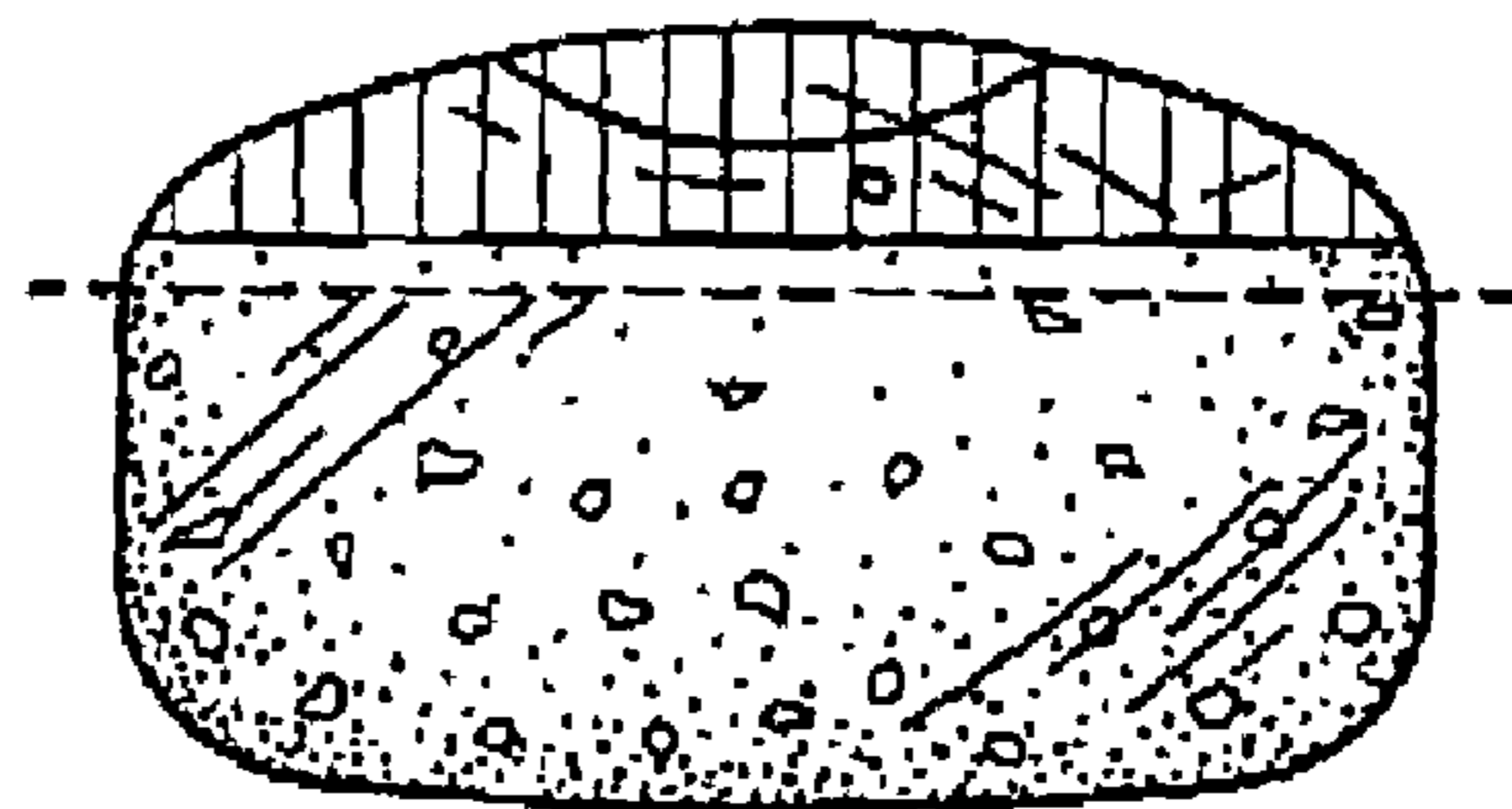

FIG. 20