

US00D564892S

(12) **United States Design Patent**  
**di Robilant et al.**

(10) **Patent No.: US D564,892 S**  
(45) **Date of Patent: \*\* Mar. 25, 2008**

(54) **BOTTLE**

**DESCRIPTION**

(75) Inventors: **Maurizio di Robilant**, Milan (IT);  
**Giuliano Dell’Orto**, Milan (IT)  
(73) Assignee: **Bacardi & Company Limited**, Vaduz  
(LI)  
(\*\*) Term: **14 Years**  
(21) Appl. No.: **29/250,525**  
(22) Filed: **Nov. 17, 2006**  
(30) **Foreign Application Priority Data**  
May 17, 2006 (DE) ..... 308  
(51) **LOC (8) Cl.** ..... **09-01**  
(52) **U.S. Cl.** ..... **D9/546; D9/544**  
(58) **Field of Classification Search** ..... D9/516,  
D9/520, 538, 539, 541, 542, 543, 544, 545,  
D9/546, 559, 560, 562, 563, 571, 572, 573,  
D9/574, 575; 220/660, 662, 669, 675; 215/381–384,  
215/396, 398, 400  
See application file for complete search history.

(56) **References Cited**

**U.S. PATENT DOCUMENTS**

D45,565 S \* 4/1914 Lloyd ..... D9/522  
D52,423 S \* 9/1918 Anderson ..... D9/656

(Continued)

**OTHER PUBLICATIONS**

Photograph of Martini & Rossi bottle, dated Nov. 1, 2006.

*Primary Examiner*—Daniel Bui  
*Assistant Examiner*—Elizabeth J Oswecki

(74) *Attorney, Agent, or Firm*—Edwards Angell Palmer &  
Dodge LLP

(57) **CLAIM**

The ornamental design for a bottle, as shown and described.

FIG. 1 is a front view of a first embodiment of a bottle showing our new design;  
FIG. 2 is a rear view thereof;  
FIG. 3 is a left side view thereof;  
FIG. 4 is a right side view thereof;  
FIG. 5 is a top view thereof;  
FIG. 6 is a bottom view thereof.  
FIG. 7 is a front view of a second embodiment of a bottle shown in FIG. 1;  
FIG. 8 is a rear view thereof;  
FIG. 9 is a left view thereof;  
FIG. 10 is a right side view thereof;  
FIG. 11 is a top view thereof;  
FIG. 12 is a bottom view thereof;  
FIG. 13 is a front view of a third embodiment of a bottle shown in FIG. 1;  
FIG. 14 is a rear view thereof;  
FIG. 15 is a left side view thereof;  
FIG. 16 is a right side view thereof;  
FIG. 17 is a top view thereof;  
FIG. 18 is a bottom view thereof;  
FIG. 19 is a front view of a fourth embodiment of a bottle shown in FIG. 1;  
FIG. 20 is a rear view thereof;  
FIG. 21 is a left side view thereof;  
FIG. 22 is a right side view thereof;  
FIG. 23 is a top view thereof; and,  
FIG. 24 is a bottom view thereof.  
The broken line showing of the screw thread and bottom ridges is for illustrative purposes only and forms no part of the claimed design.

**1 Claim, 12 Drawing Sheets**

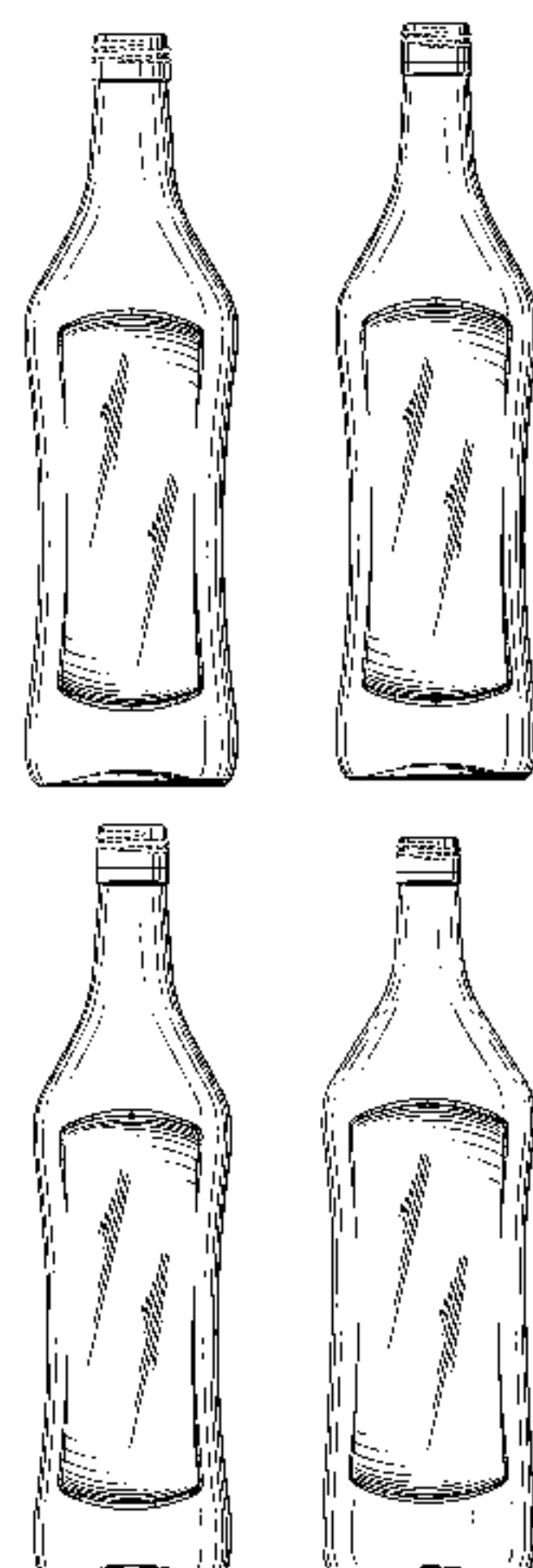

# US D564,892 S

Page 2

---

## U.S. PATENT DOCUMENTS

D82,202 S *	9/1930	Winegard .....	D9/542	D387,668 S *	12/1997	Bond .....	D9/520
D86,024 S *	1/1932	Holmes .....	D9/542	D436,852 S *	1/2001	Chan .....	D9/738
D131,470 S *	3/1942	Key .....	D9/542	D460,697 S *	7/2002	Del Bon .....	D9/565
D142,746 S *	10/1945	Stackpole .....	D9/538	D531,902 S *	11/2006	Dolgonos .....	D9/500
D189,507 S *	12/1960	Holtz .....	D9/542	D545,205 S *	6/2007	Rica .....	D9/544
D211,562 S *	7/1968	Anderson .....	D9/500	D545,213 S *	6/2007	Werner et al. ....	D9/652
D233,738 S *	11/1974	Latorre .....	D9/538	D548,098 S *	8/2007	Lauret .....	D9/544
D343,580 S *	1/1994	Reynaud .....	D9/560				

\* cited by examiner

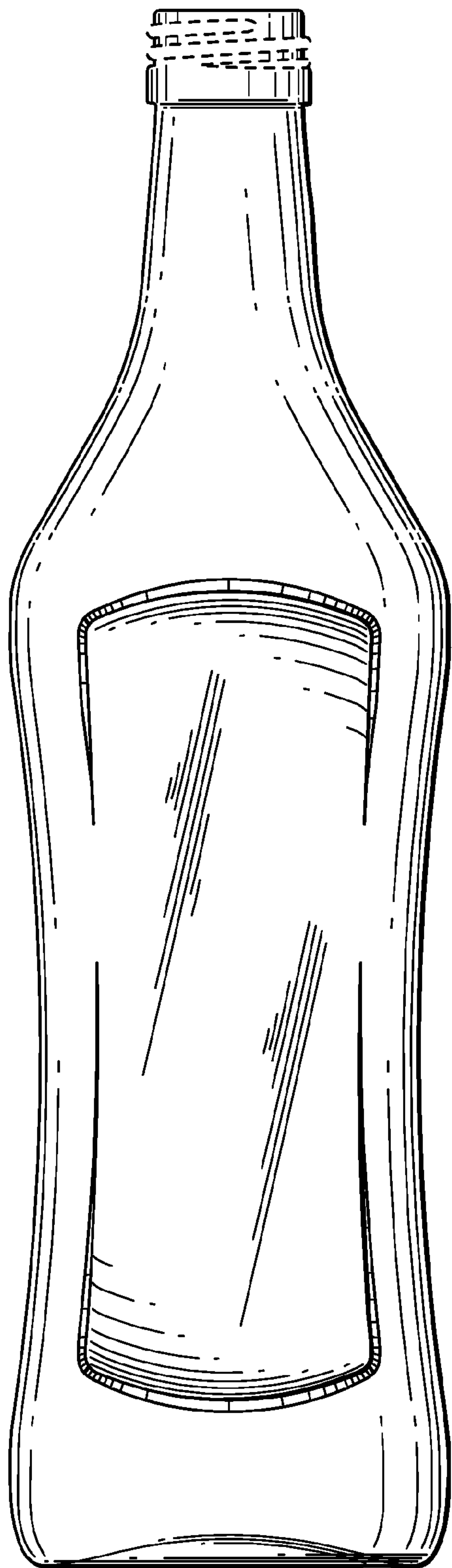

FIG. 1

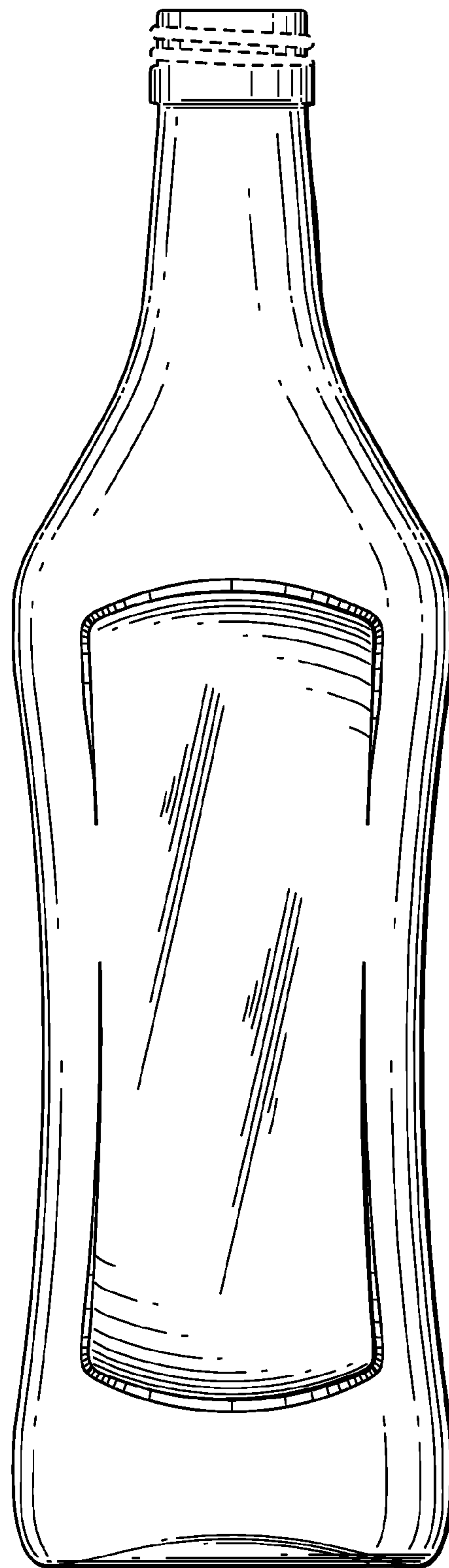

FIG. 2

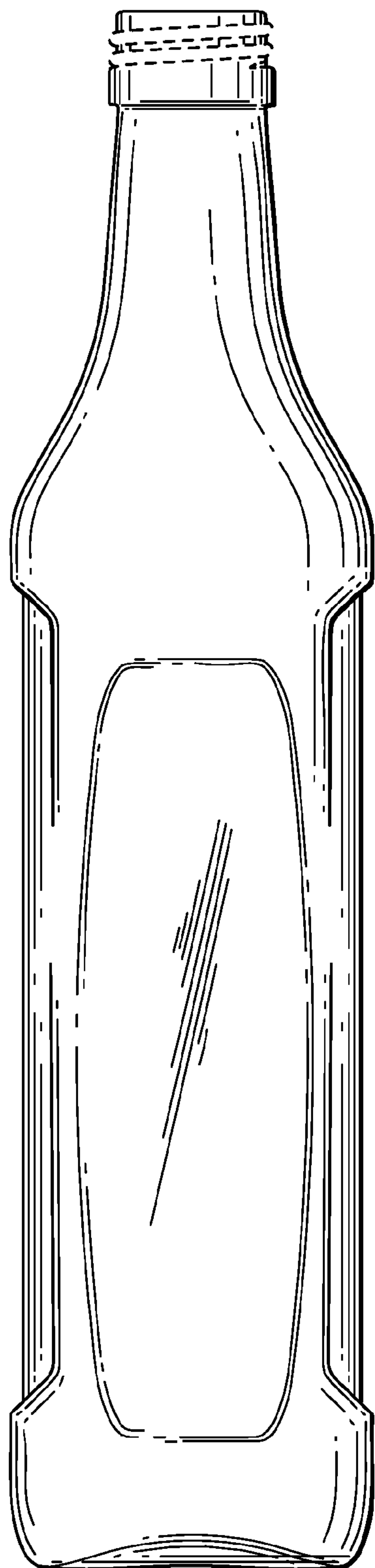

FIG. 3

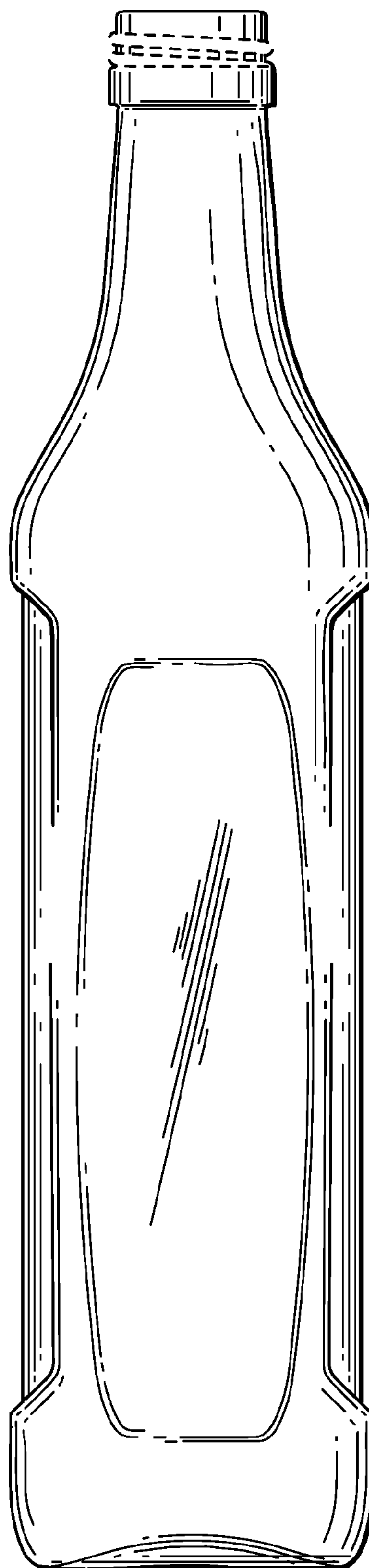
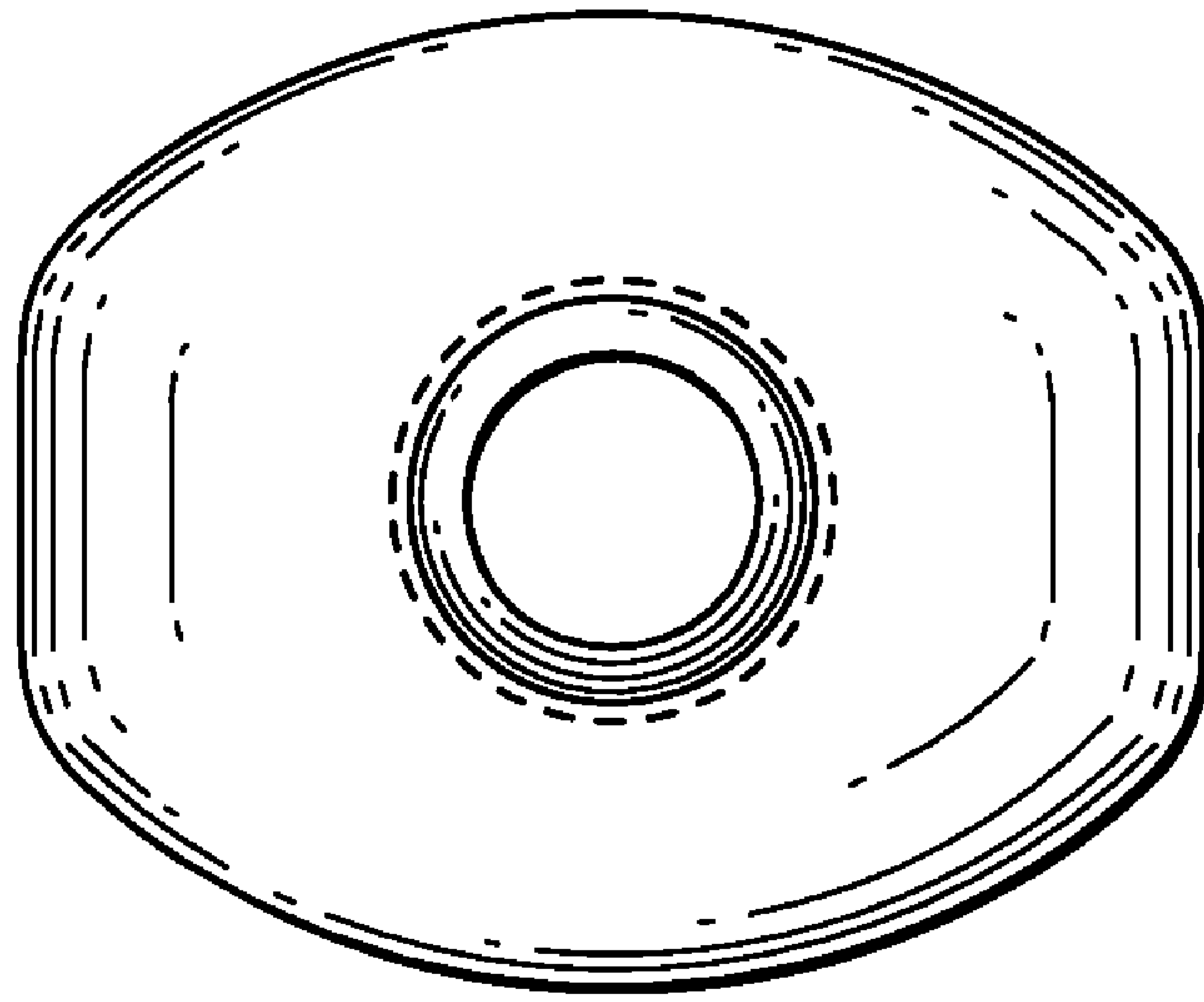
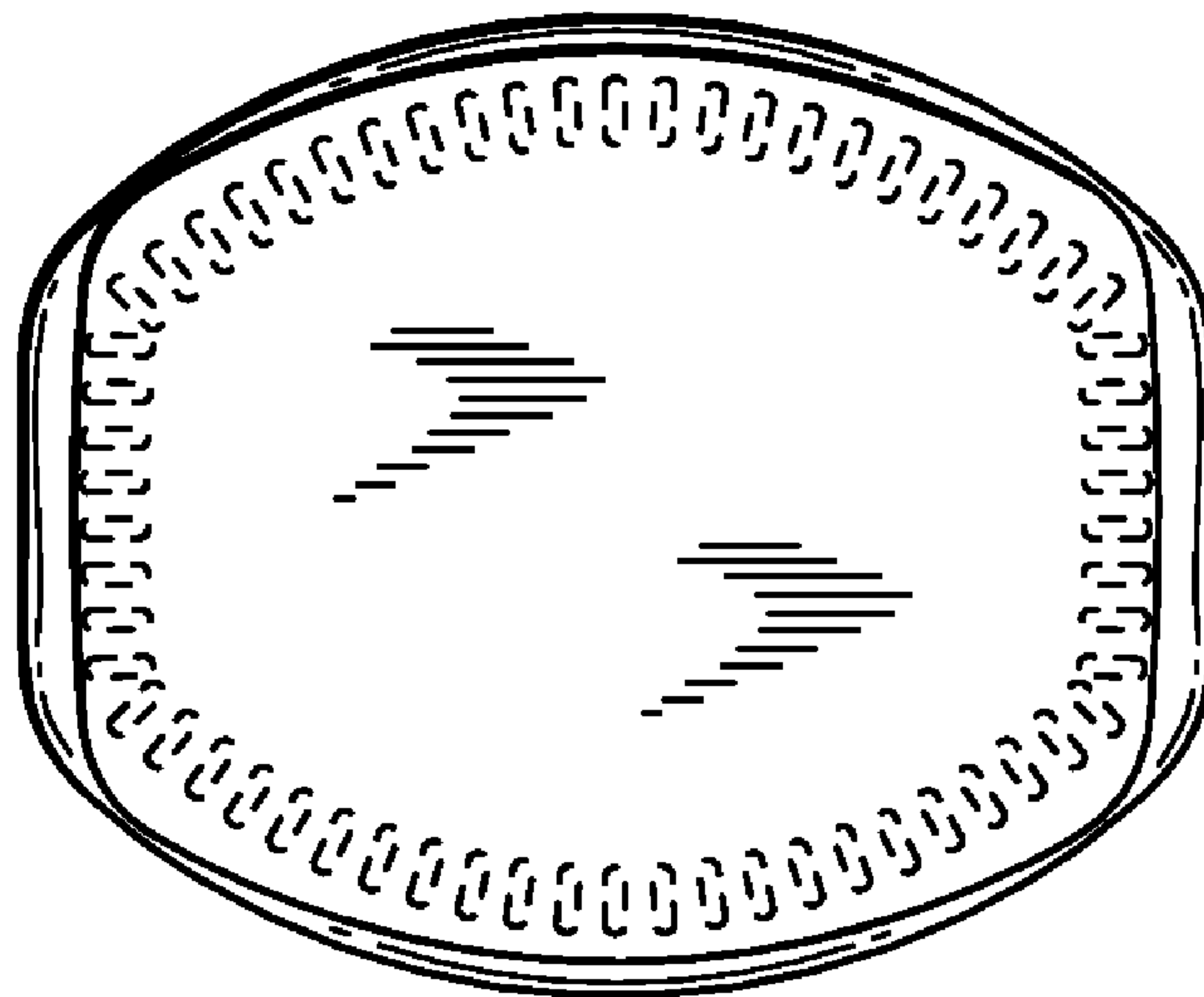

FIG. 4



*FIG. 5*



*FIG. 6*



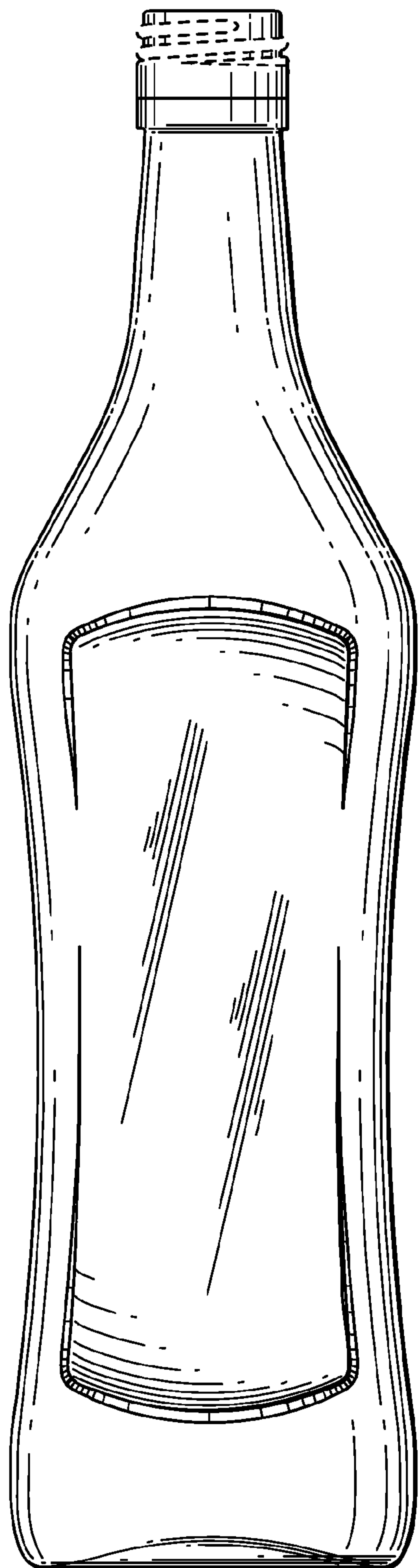

FIG. 7

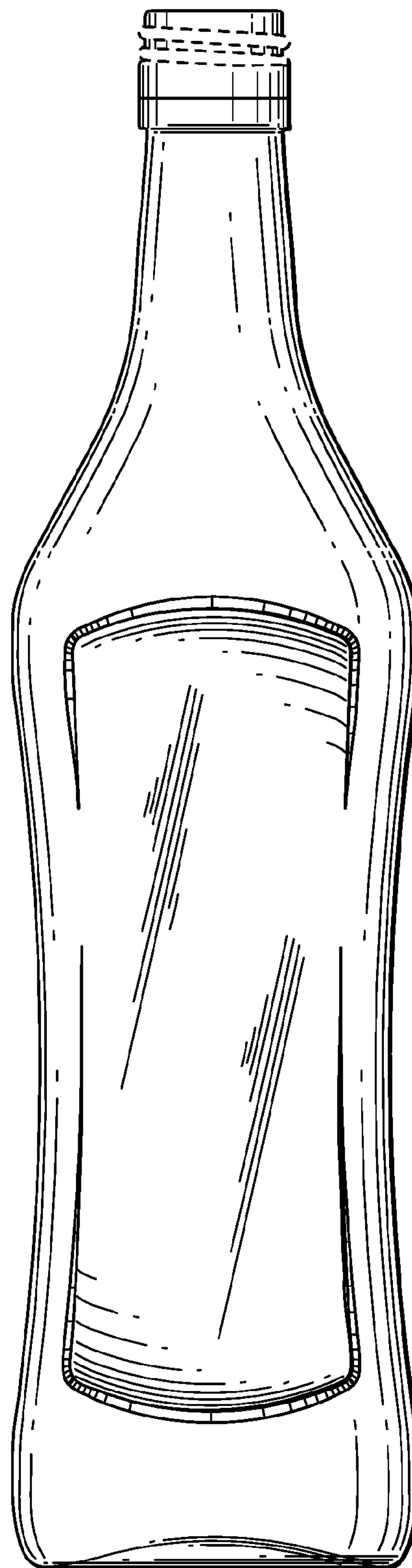

FIG. 8

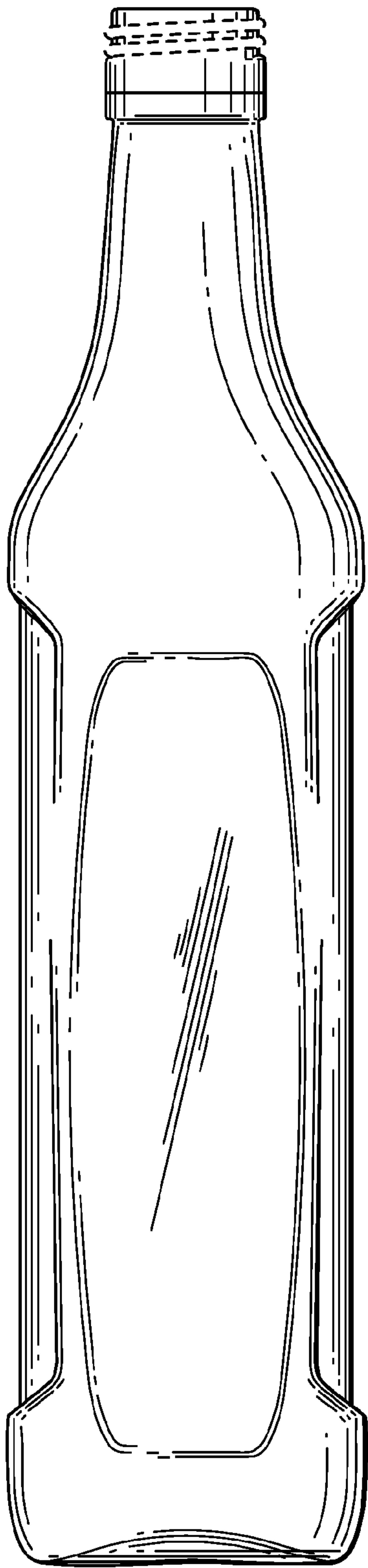

FIG. 9

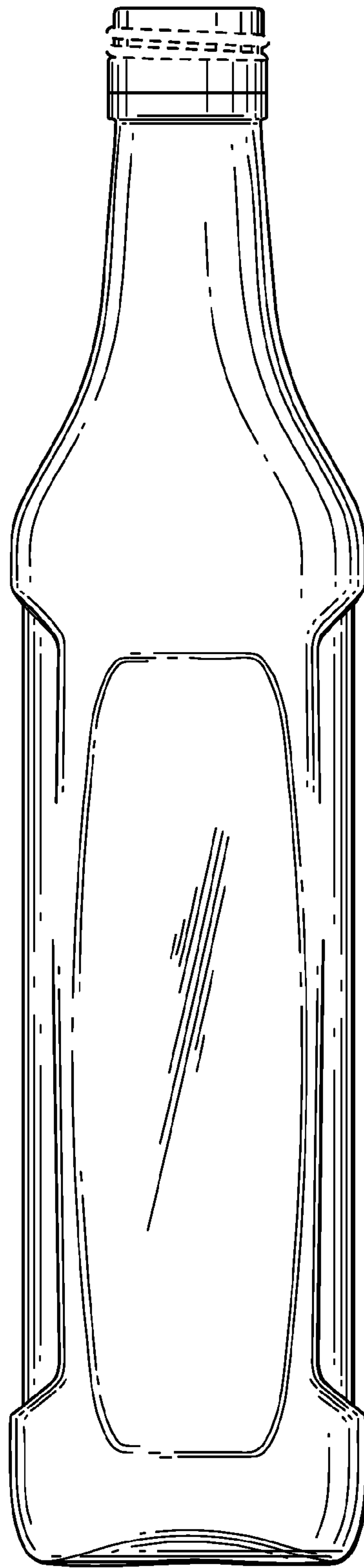
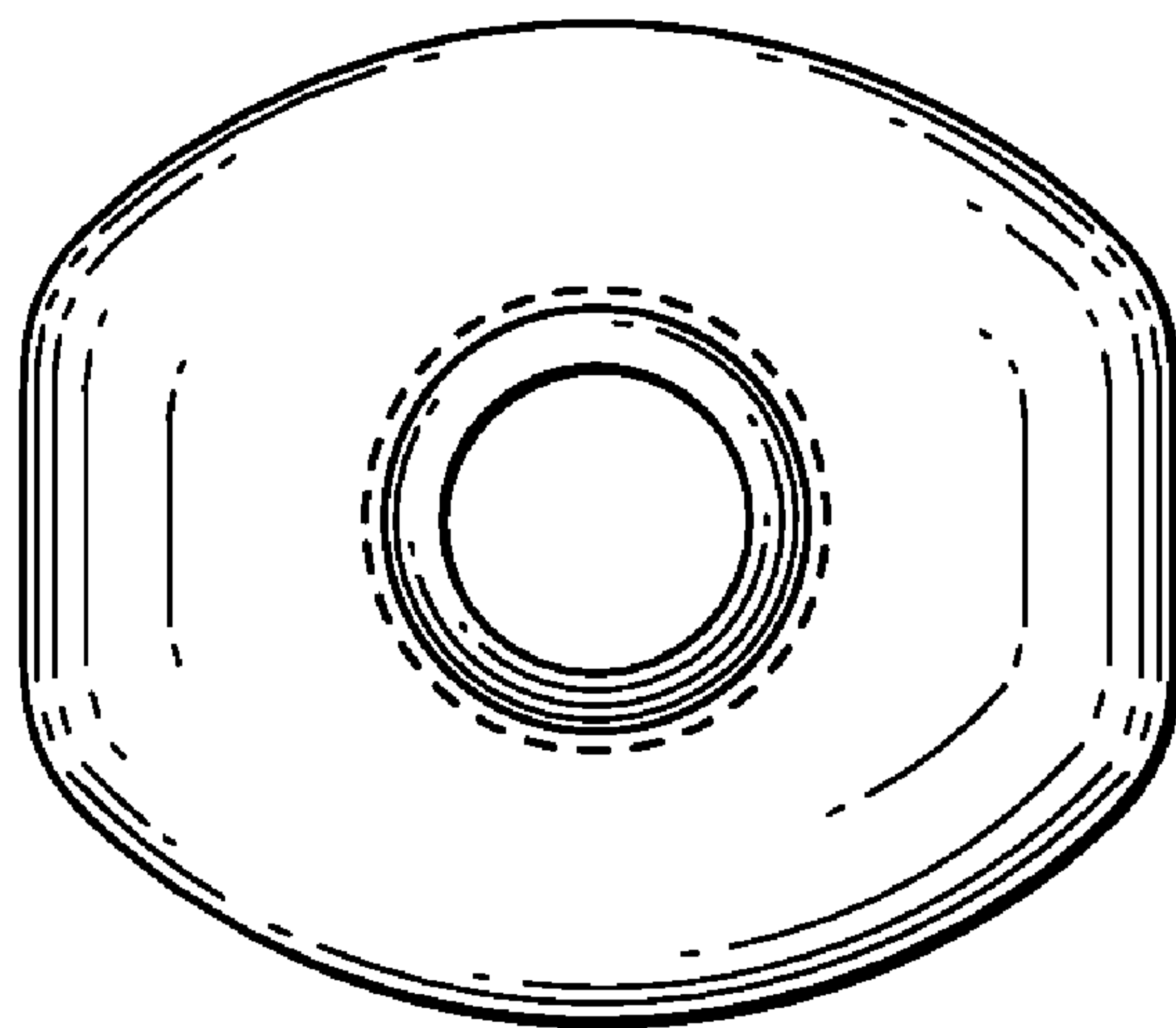
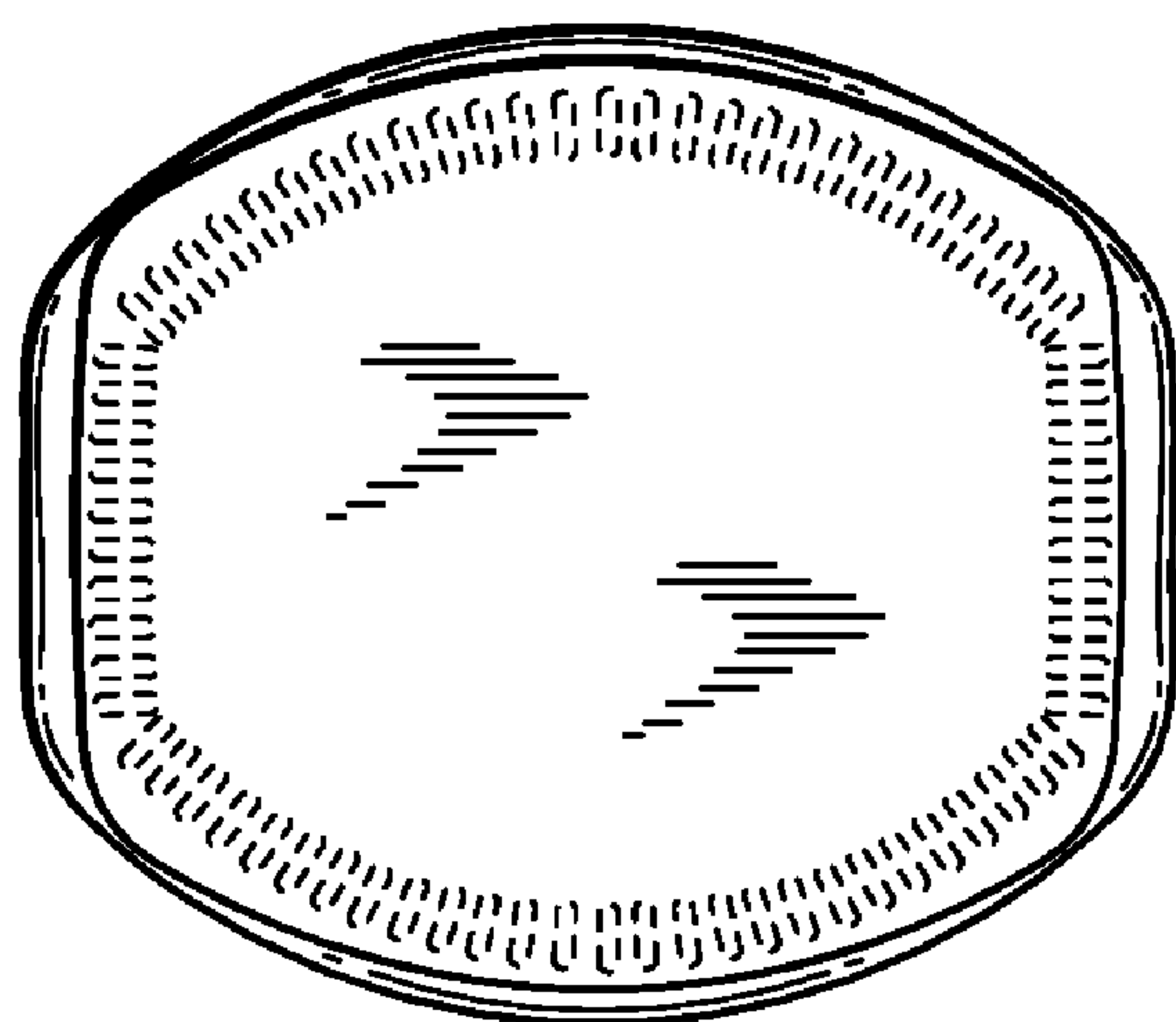

FIG. 10



*FIG. 11*



*FIG. 12*



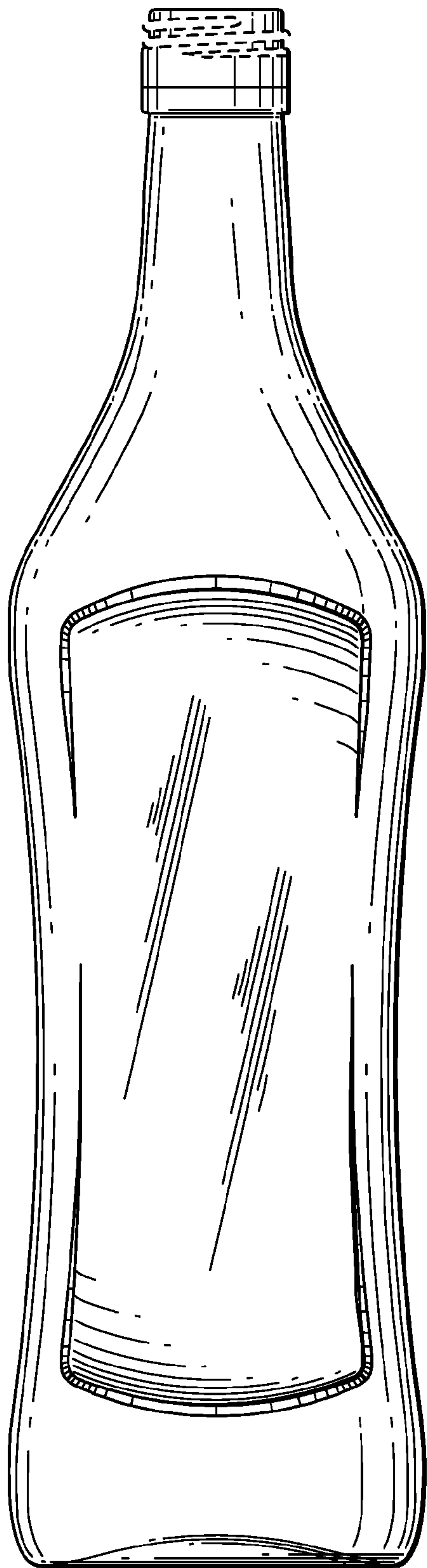

FIG. 13

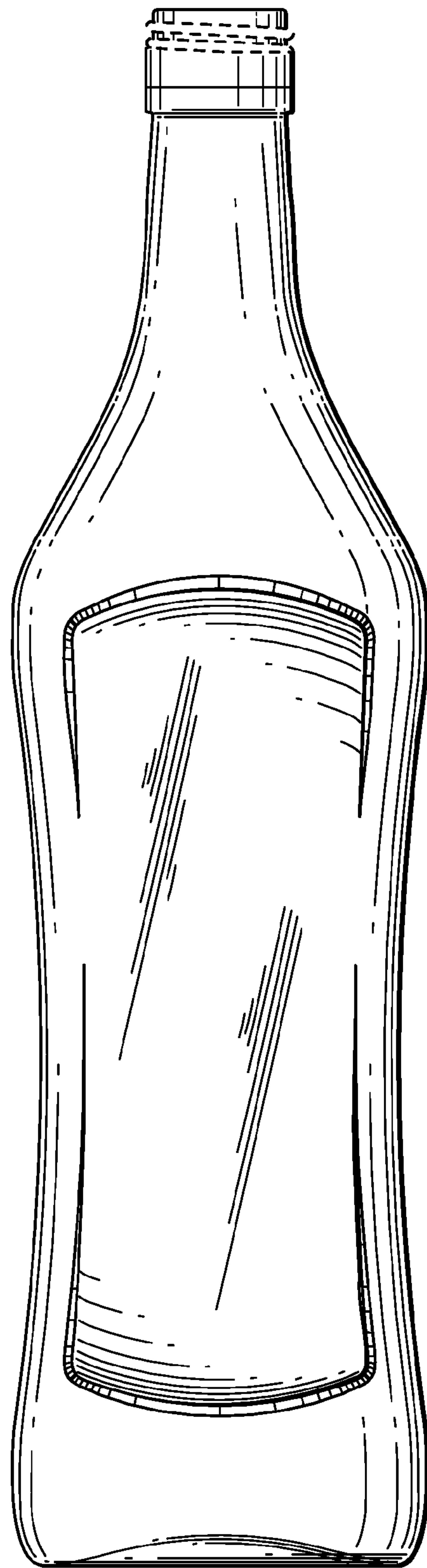

FIG. 14

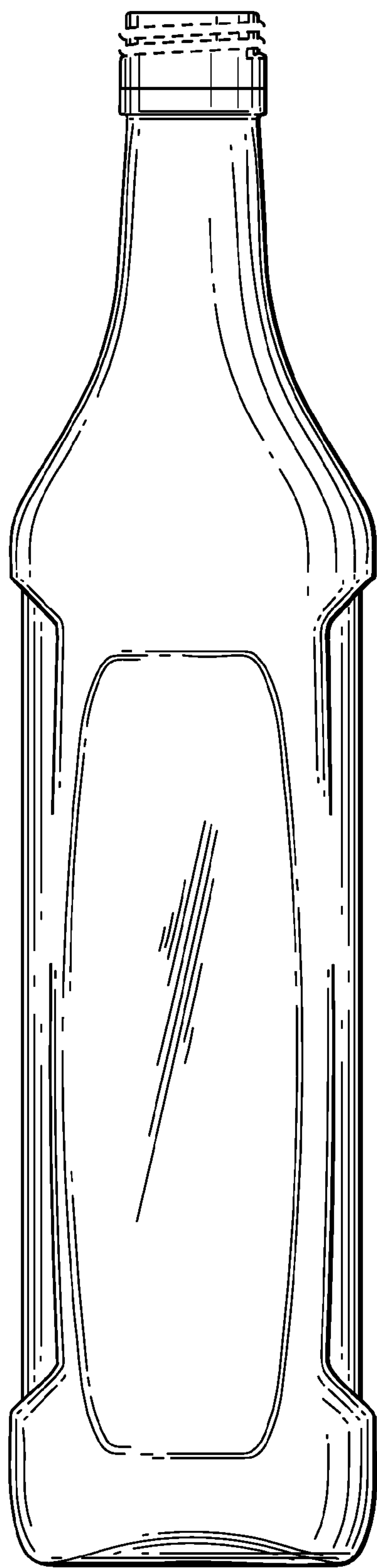

FIG. 15

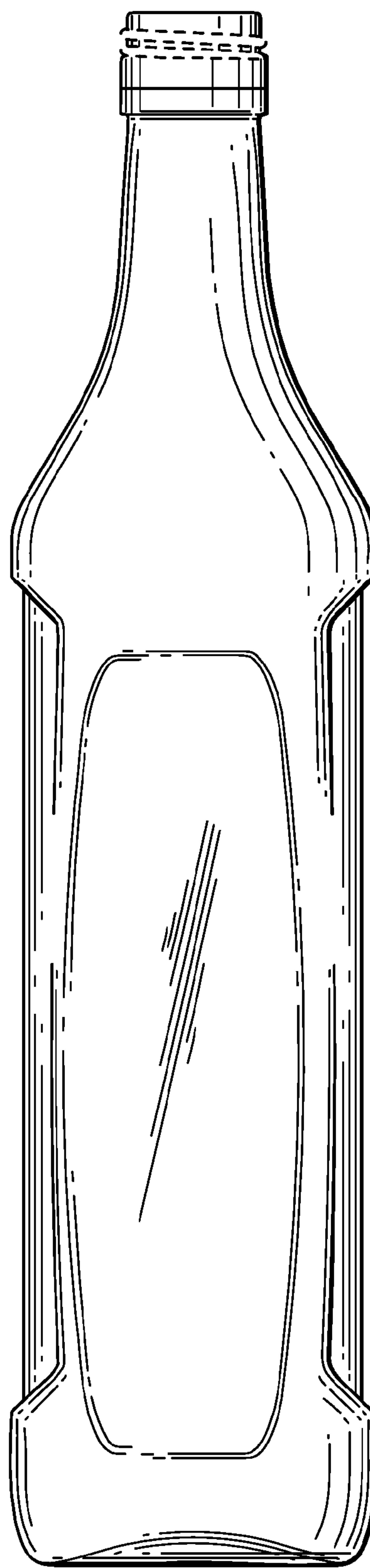
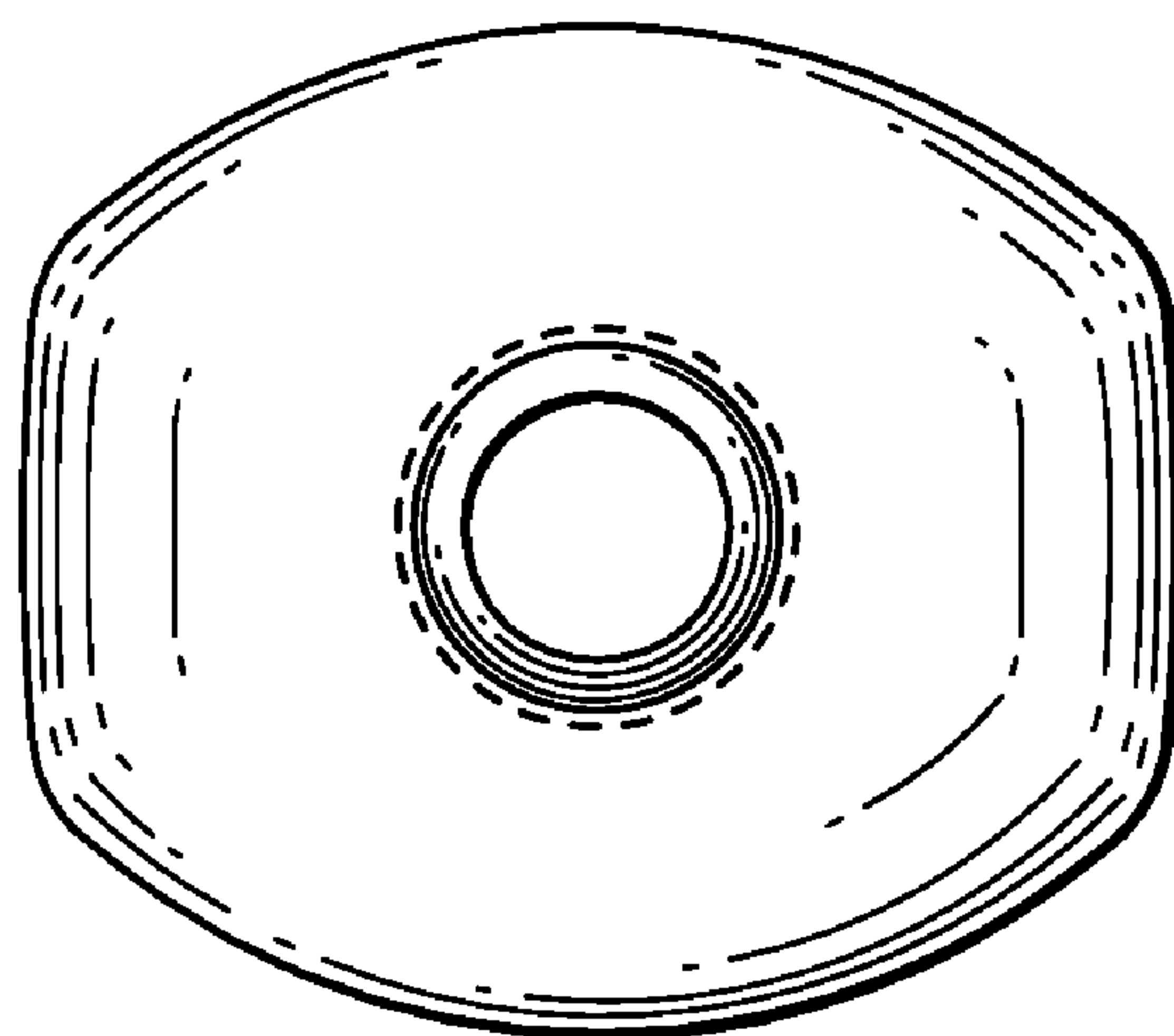
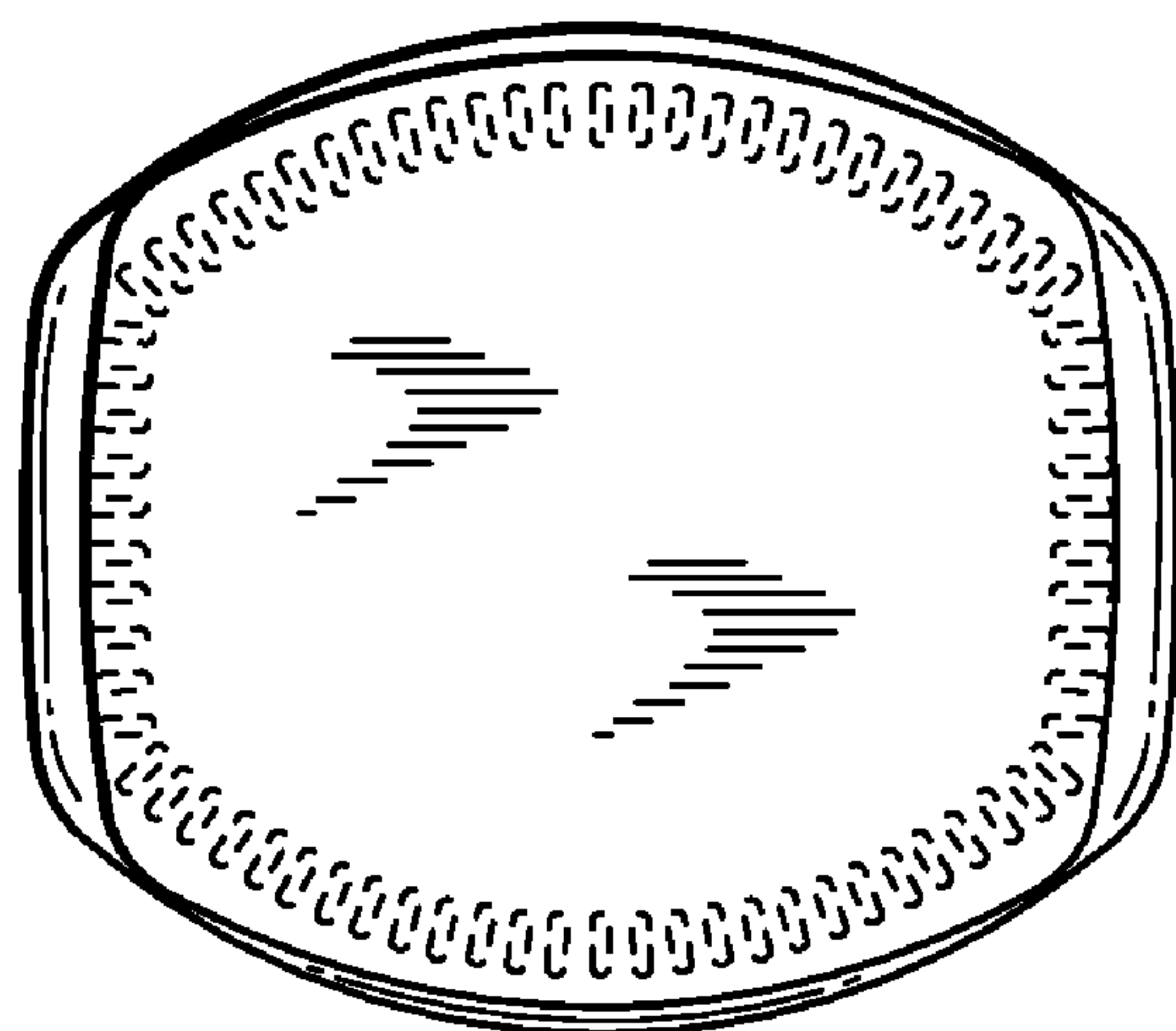

FIG. 16



*FIG. 17*



*FIG. 18*

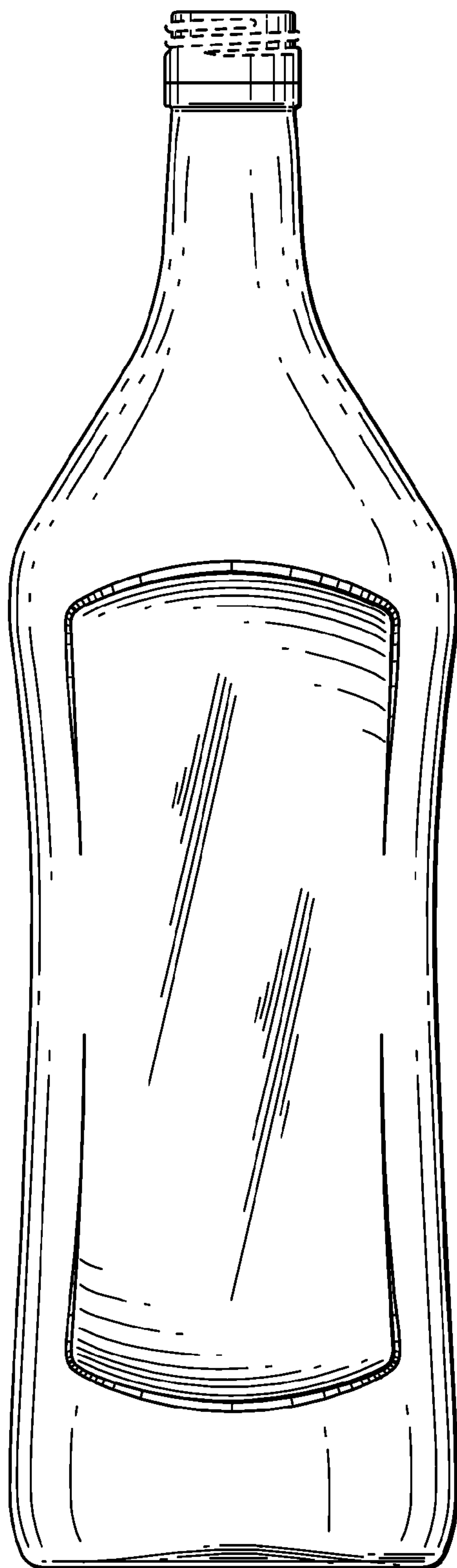

FIG. 19

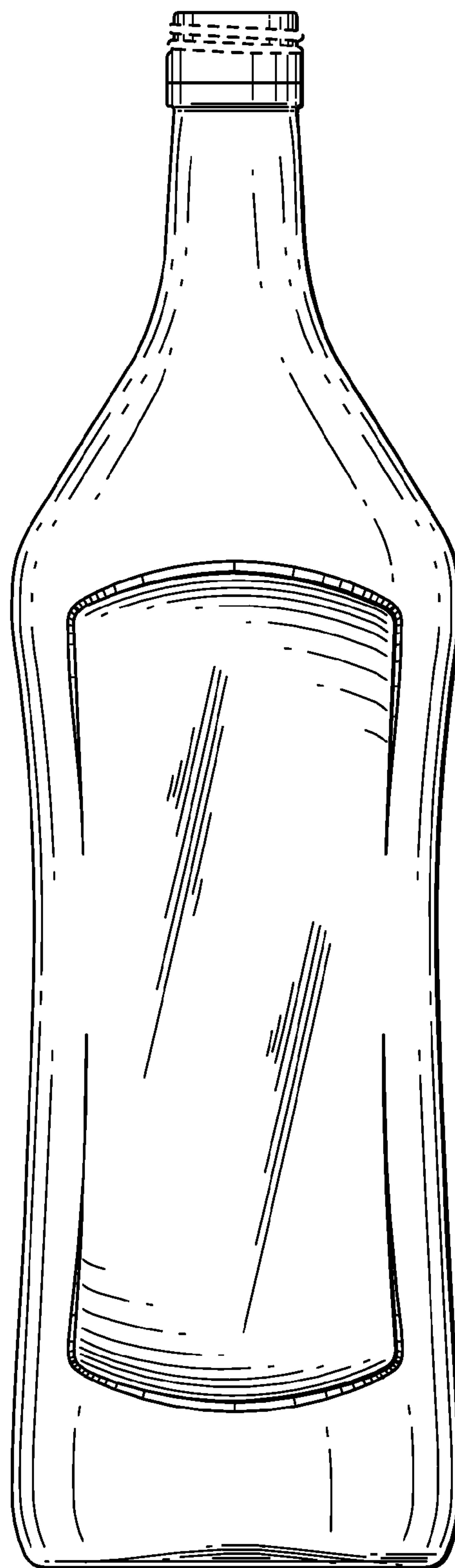

FIG. 20

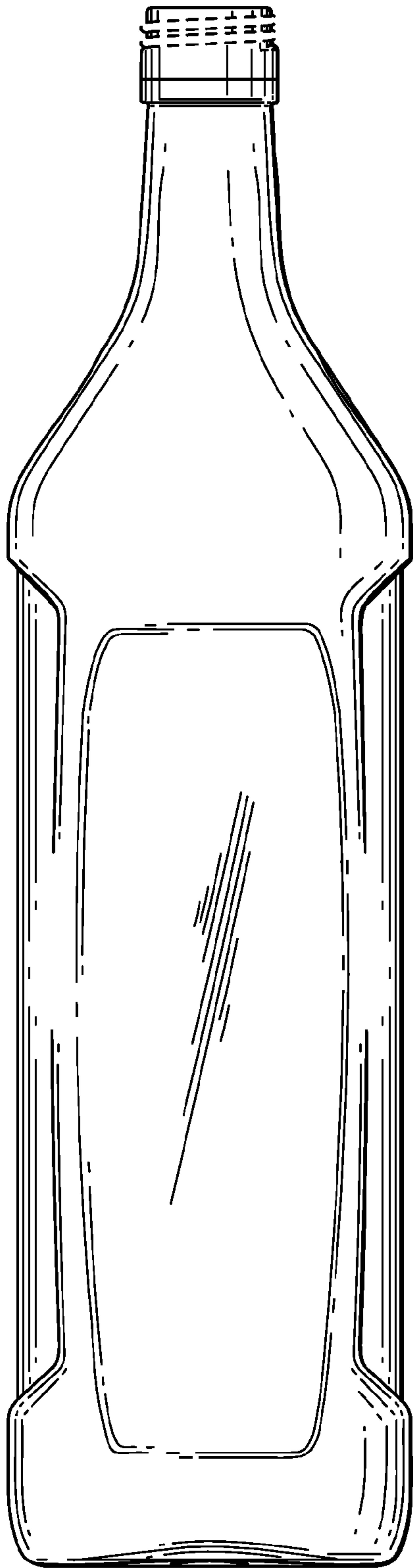

FIG. 21

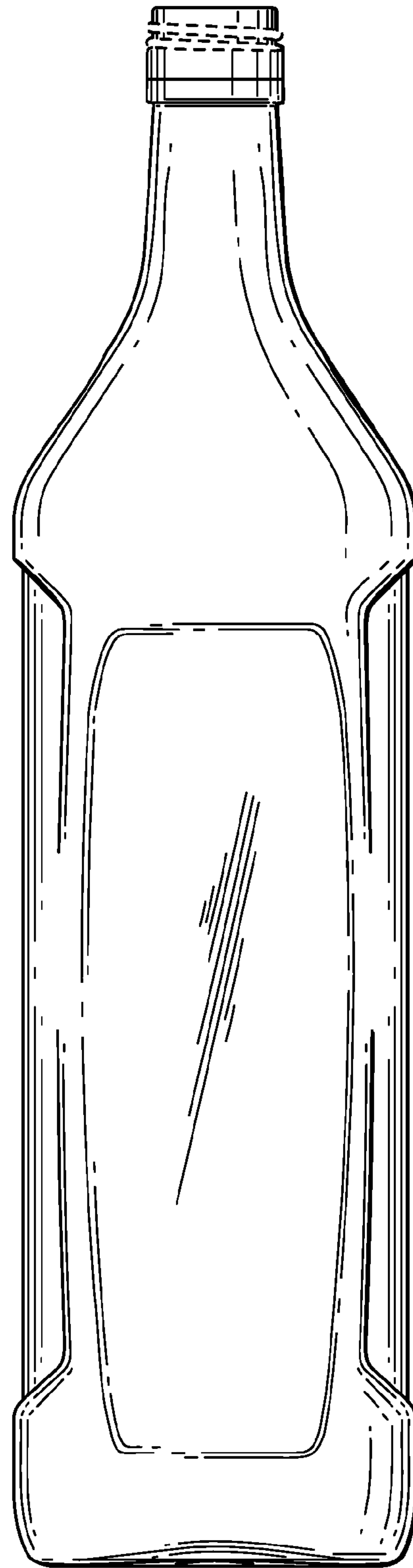
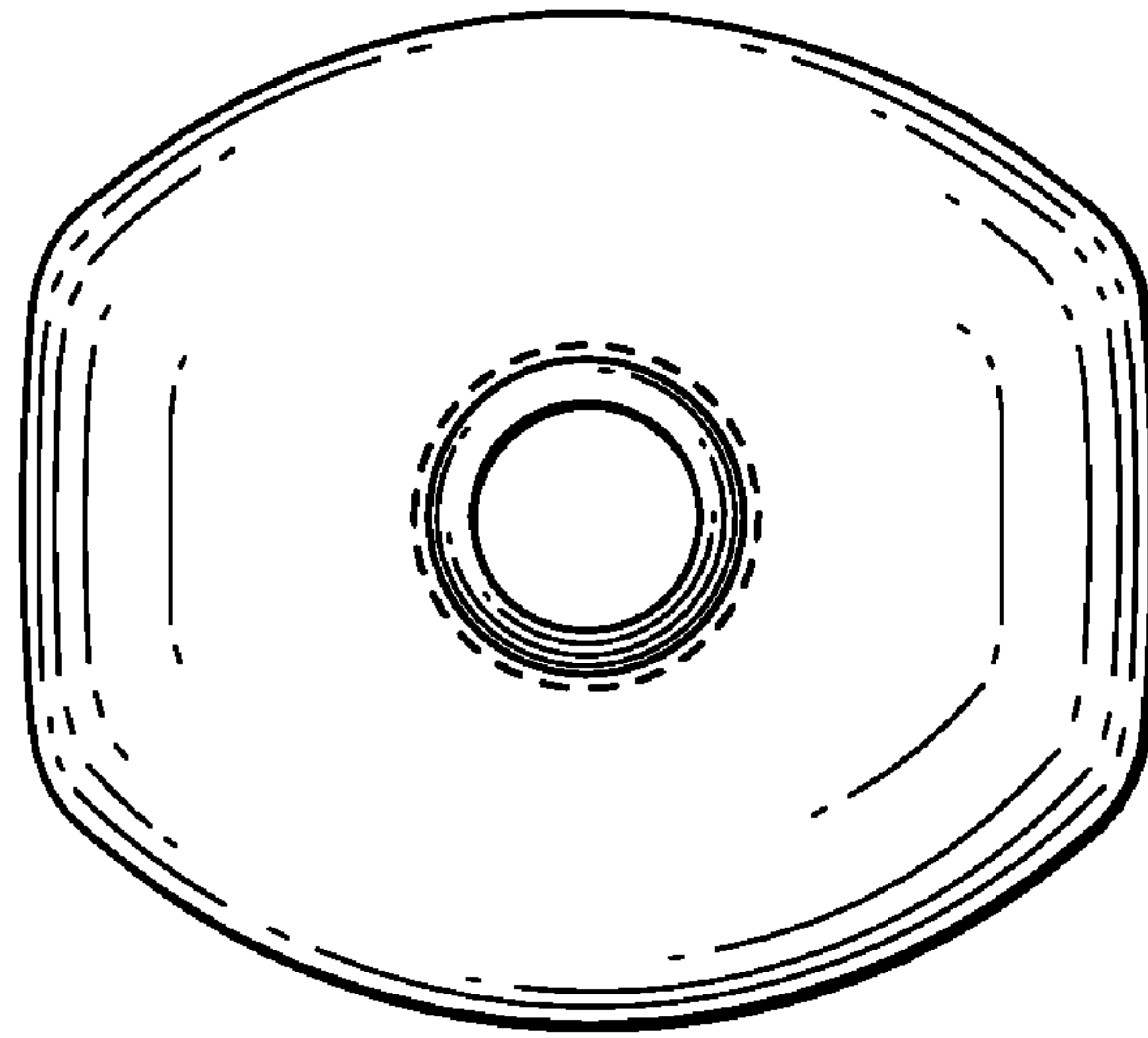
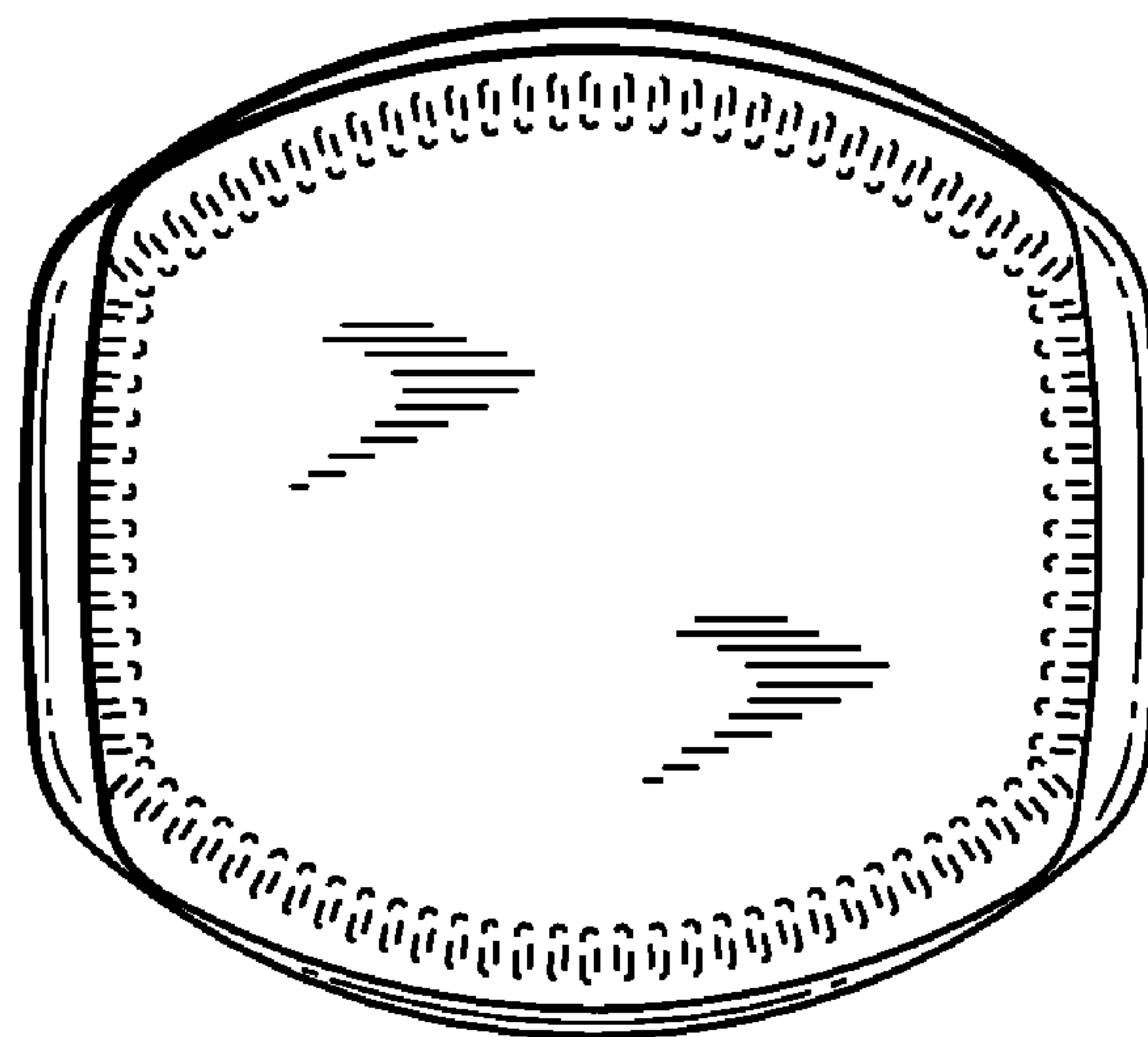

FIG. 22



*FIG. 23*



*FIG. 24*