



US00D564880S

(12) **United States Design Patent**
Chang

(10) **Patent No.:** **US D564,880 S**

(45) **Date of Patent:** **** Mar. 25, 2008**

(54) **CORNER MEMBER FOR CASING**

(76) Inventor: **Jui Yang Chang**, No. 185, Minjh Road,
Chinshui Town, Taichung Hsien 43651
(TW)

(**) Term: **14 Years**

(21) Appl. No.: **29/258,622**

(22) Filed: **Apr. 25, 2006**

(51) **LOC (8) Cl.** **09-07**

(52) **U.S. Cl.** **D9/456**

(58) **Field of Classification Search** D9/434,
D9/435, 447, 455, 456, 499, 520, 559; 215/40,
215/43, 44, 45, 46, 219, 204, 222, 252, 318,
215/331; 75/57.1, 71; 24/455, 68; D8/72,
D8/73, 318, 349, 356, 382, 394, 395, 396;
D3/201, 232, 239, 242, 243, 256, 328; 206/409,
206/453, 523; 40/310; 403/343; 235/385,
235/380; 248/231, 200, 200.1; 220/66-70,
220/73

See application file for complete search history.

(56) **References Cited**

U.S. PATENT DOCUMENTS

D192,613 S * 4/1962 Lewer D8/382
3,404,827 A * 10/1968 Carmody 206/523
D259,083 S * 5/1981 Riegsecker D8/394
D380,680 S * 7/1997 Sun D9/456
D384,585 S * 10/1997 Swarr D9/456
D407,647 S * 4/1999 Merricks et al. D9/456
D427,894 S * 7/2000 Benz et al. D8/382

D428,804 S * 8/2000 Benz et al. D8/382
D461,714 S * 8/2002 Hamada et al. D9/456
D461,715 S * 8/2002 Hamada et al. D9/456
D484,780 S * 1/2004 Barile, Sr. D8/382
D496,853 S * 10/2004 Jones D8/394

* cited by examiner

Primary Examiner—T. Chase Nelson

Assistant Examiner—Barbara B Lohr

(74) *Attorney, Agent, or Firm*—Charles E. Baxley

(57) **CLAIM**

The ornamental design for a corner member for casing, as shown and described.

DESCRIPTION

FIG. 1 is a perspective view of a corner member for casing showing my new design;

FIG. 2 is a front elevational view thereof;

FIG. 3 is a rear elevational view thereof;

FIG. 4 is a top plan view thereof;

FIG. 5 is a bottom plan view thereof;

FIG. 6 is a left side elevational view thereof; and

FIG. 7 is a right side elevational view thereof; and,

FIG. 8 is an isometric view of the corner member for casing shown in condition of use.

The broken line showing of environmental structure and additional corner members for casing is for illustrative purposes only and forms no part of the claimed design.

1 Claim, 5 Drawing Sheets

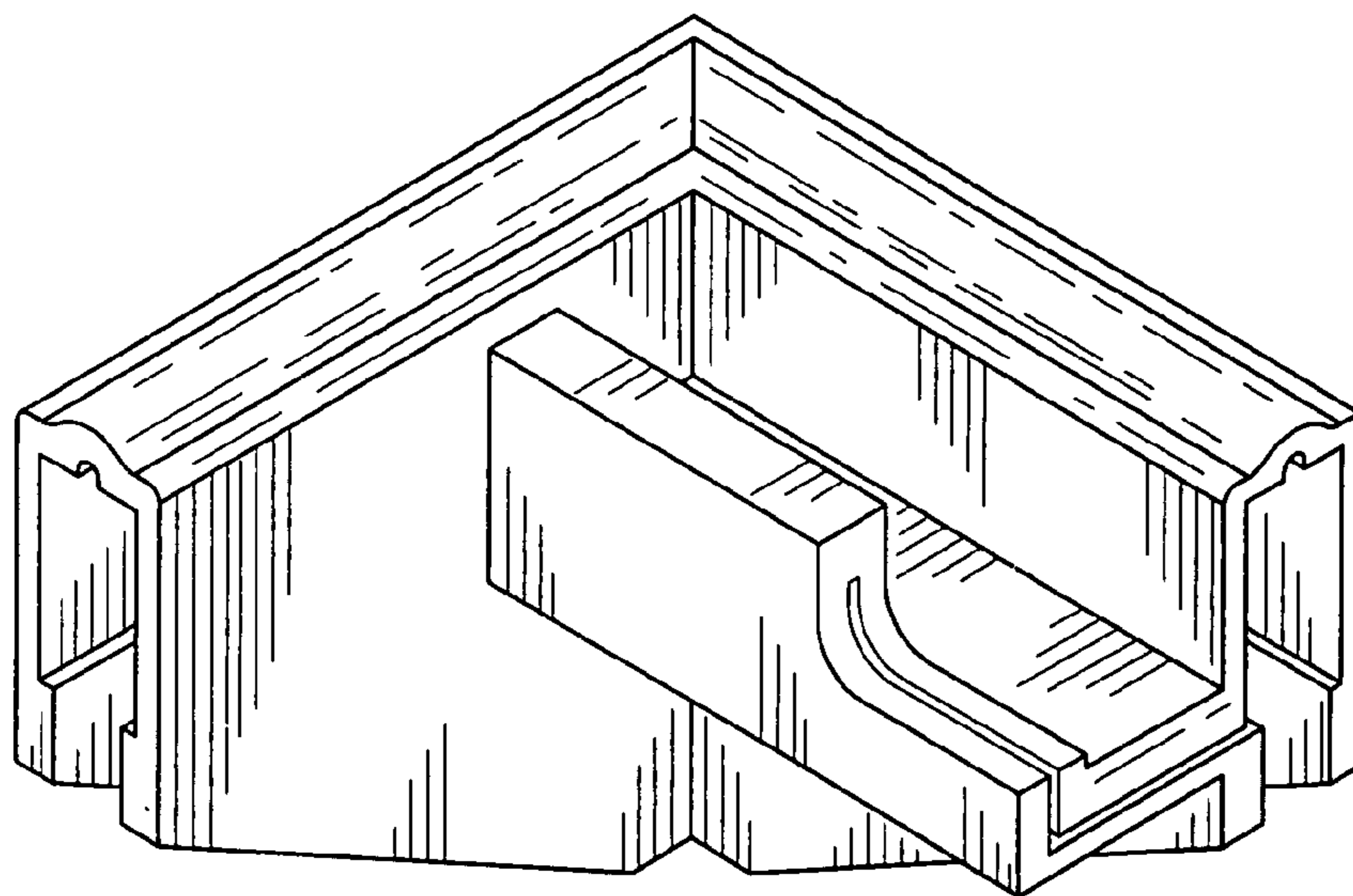

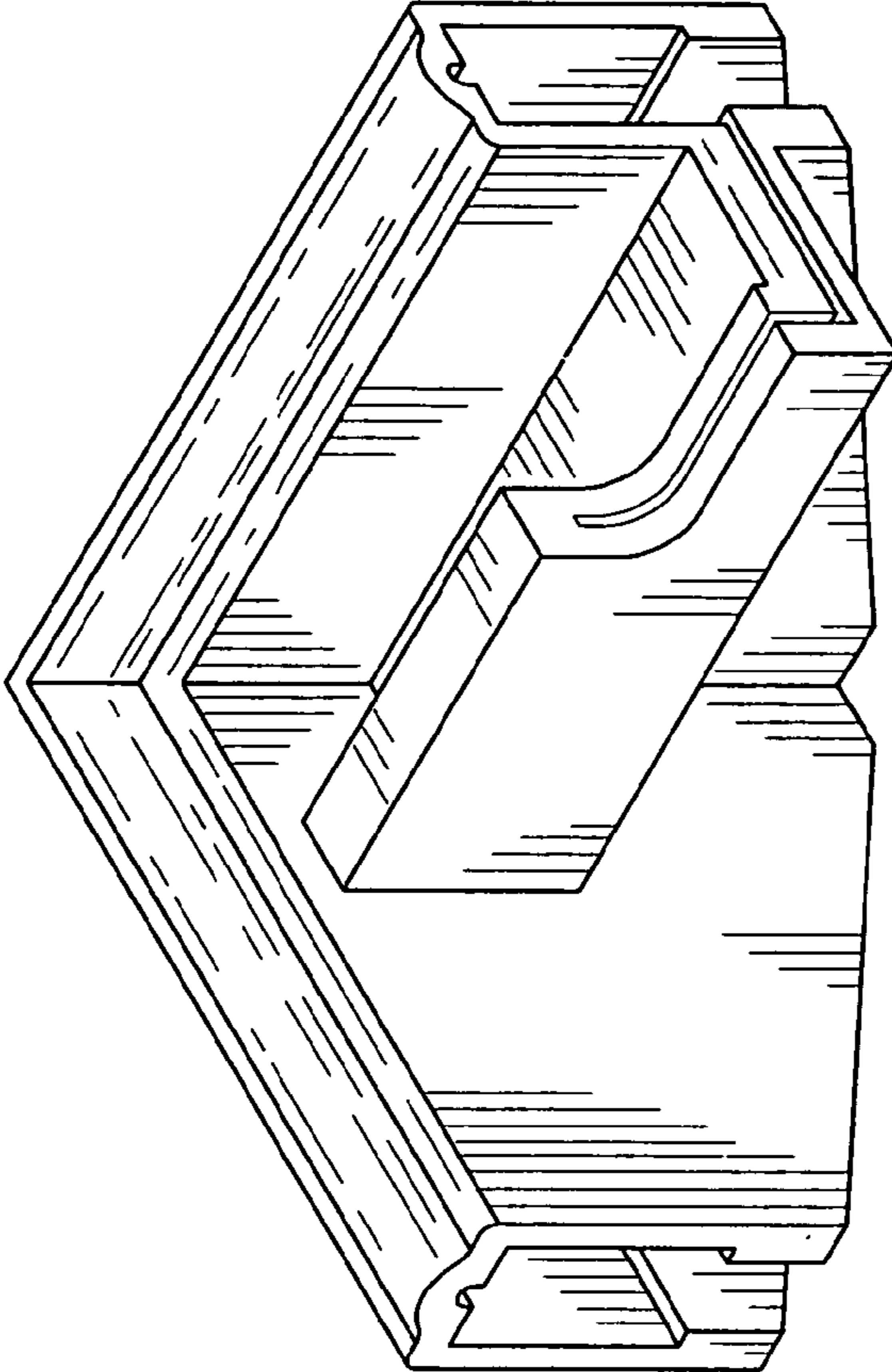

FIG. 1

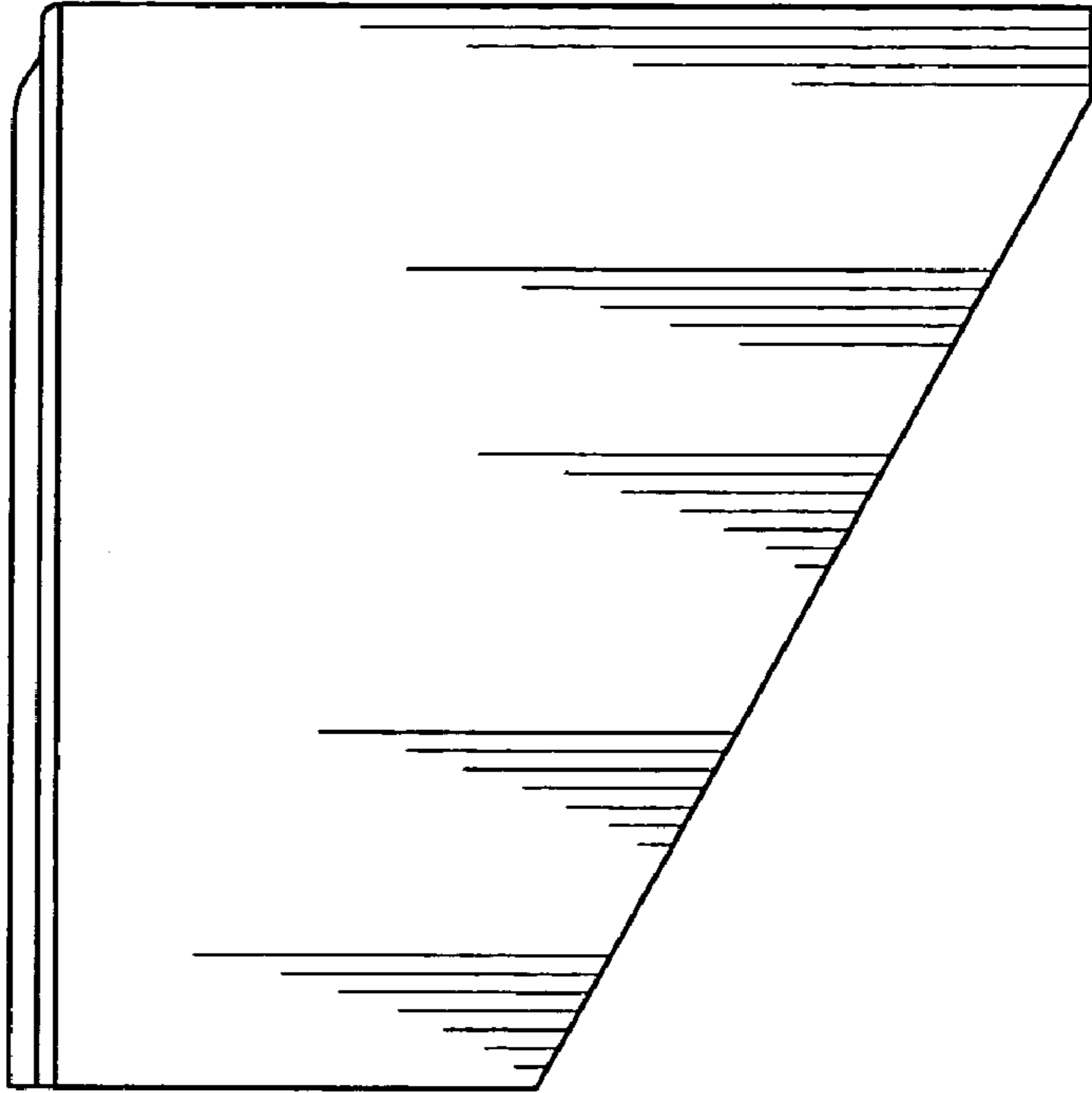

FIG. 3

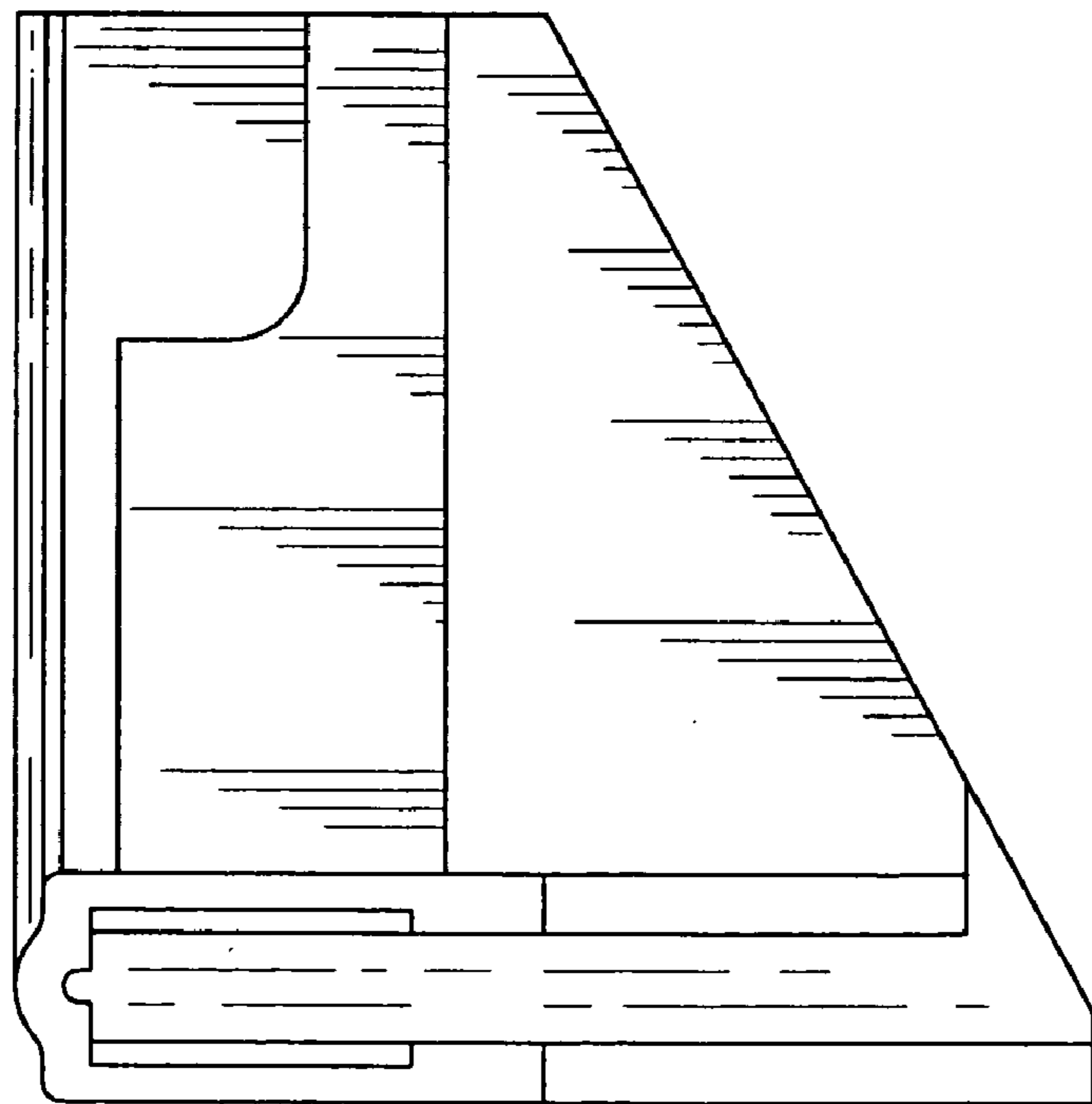

FIG. 2

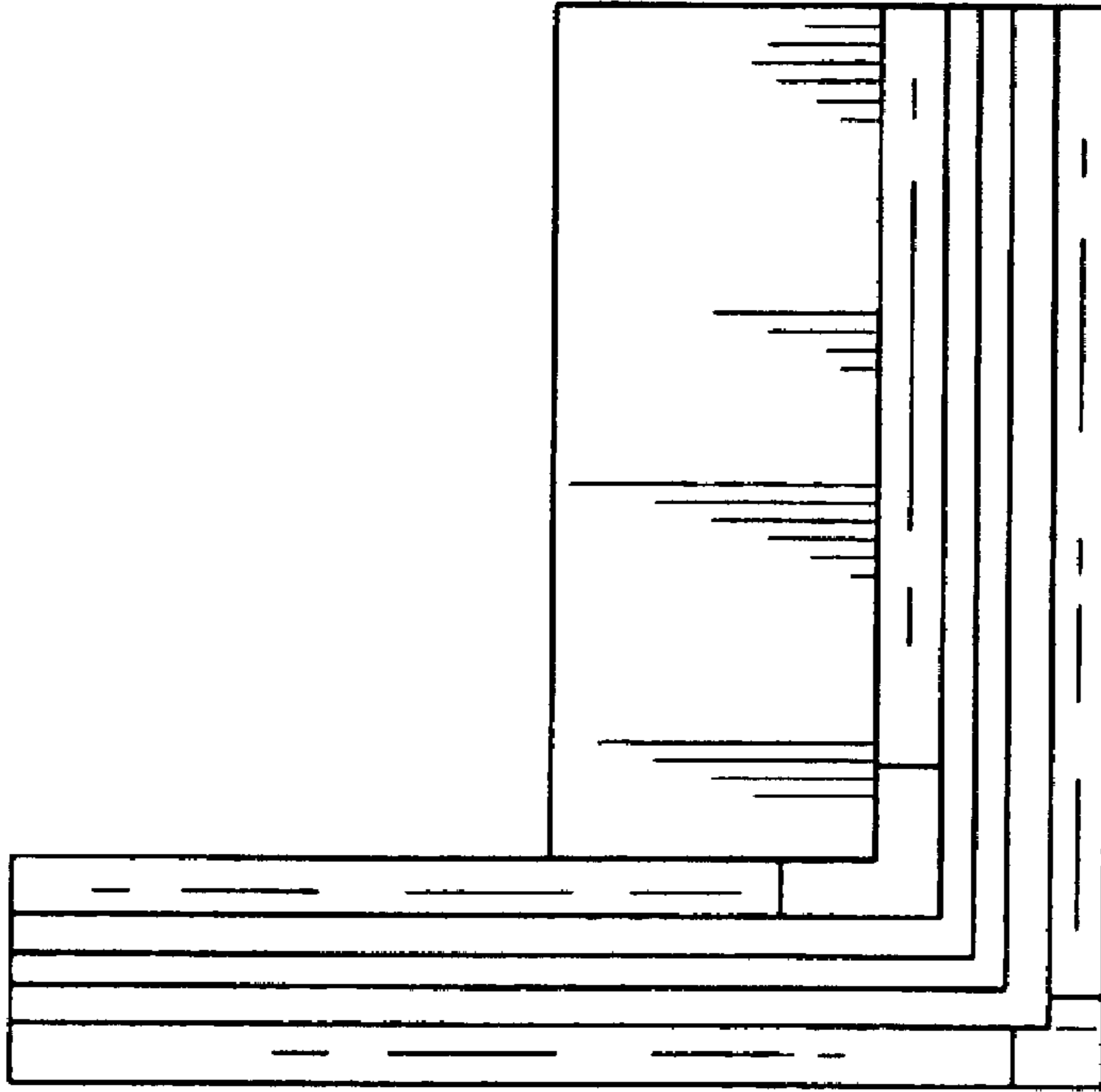

FIG. 5

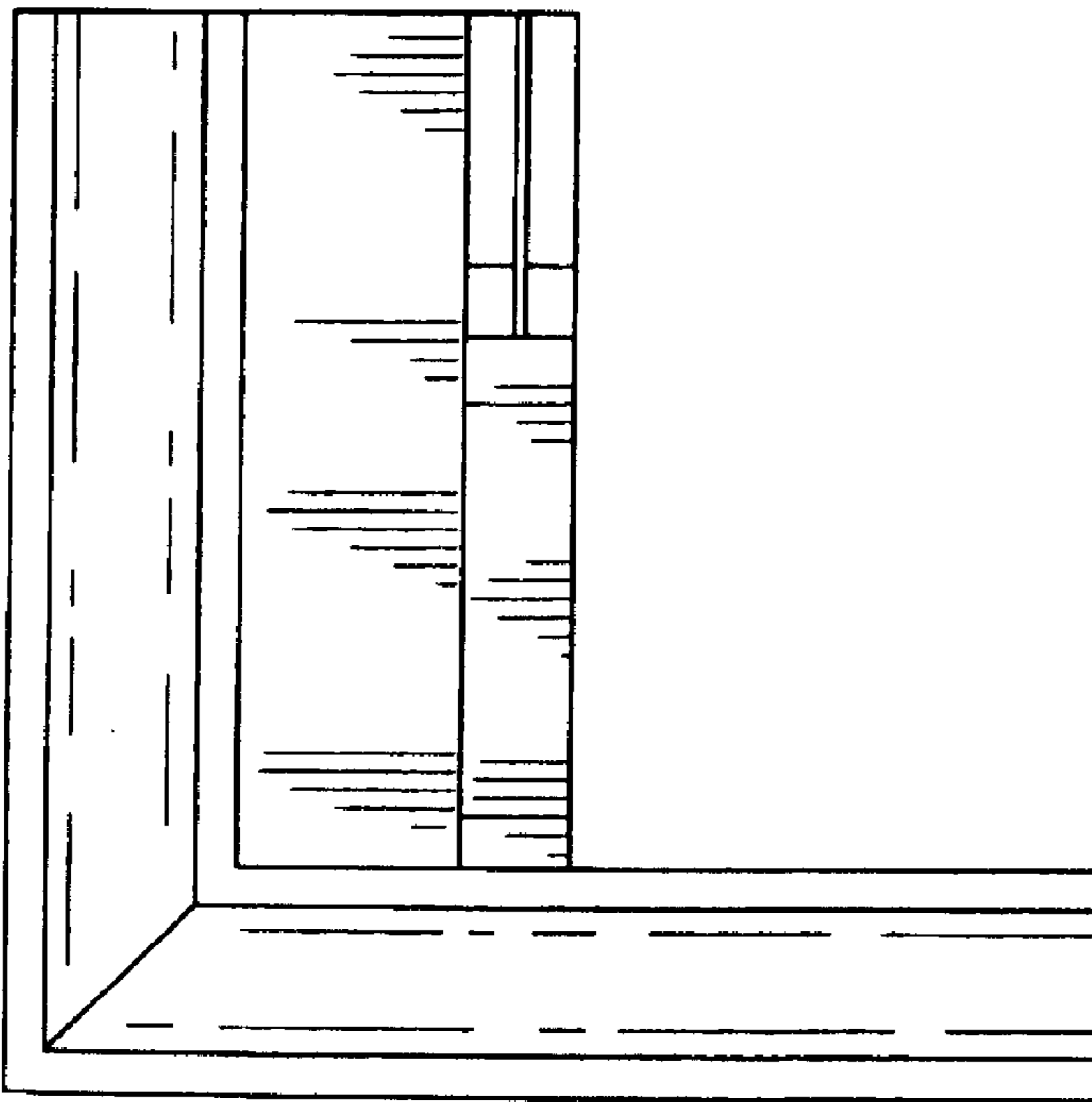

FIG. 4

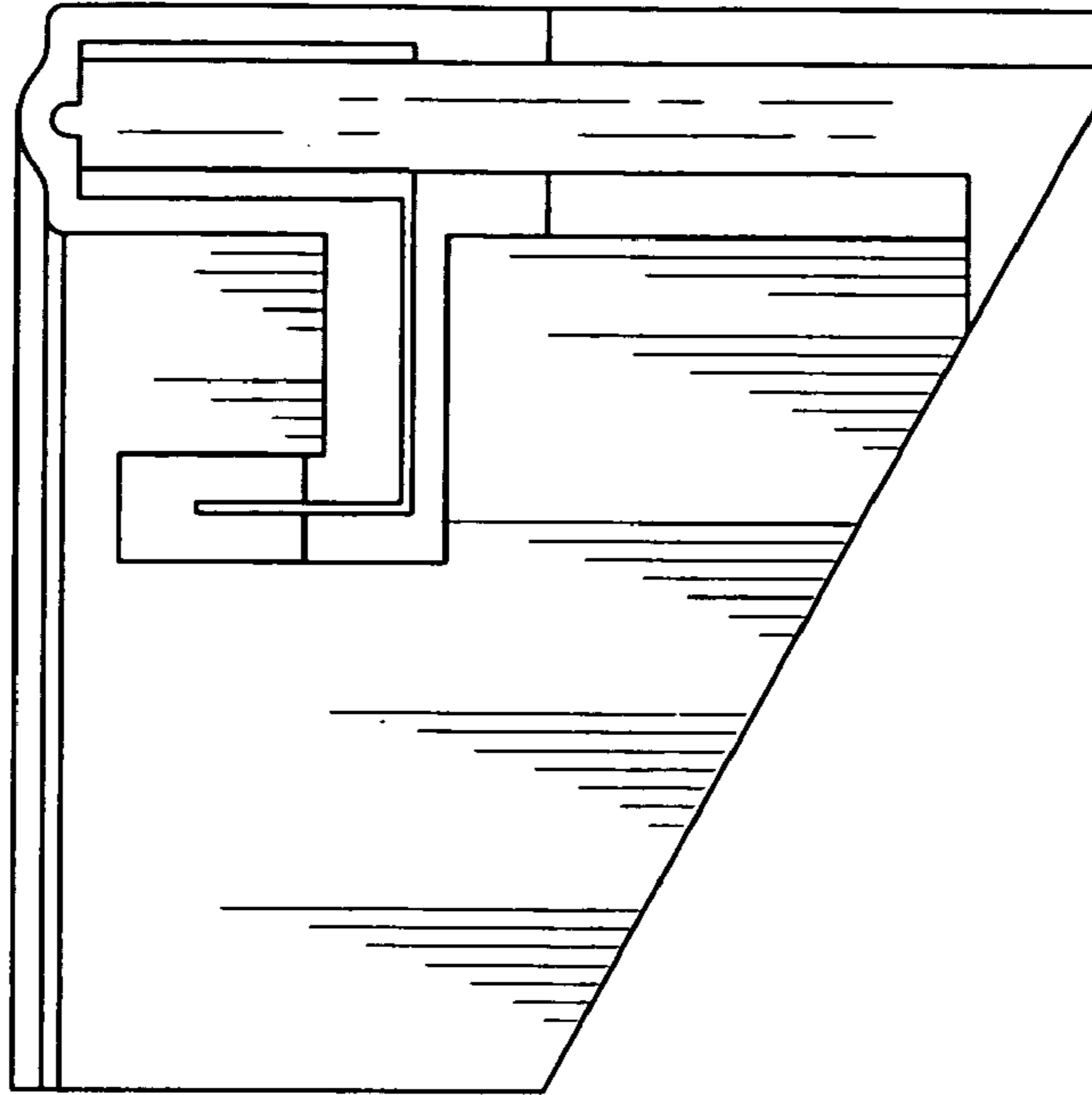

FIG. 7

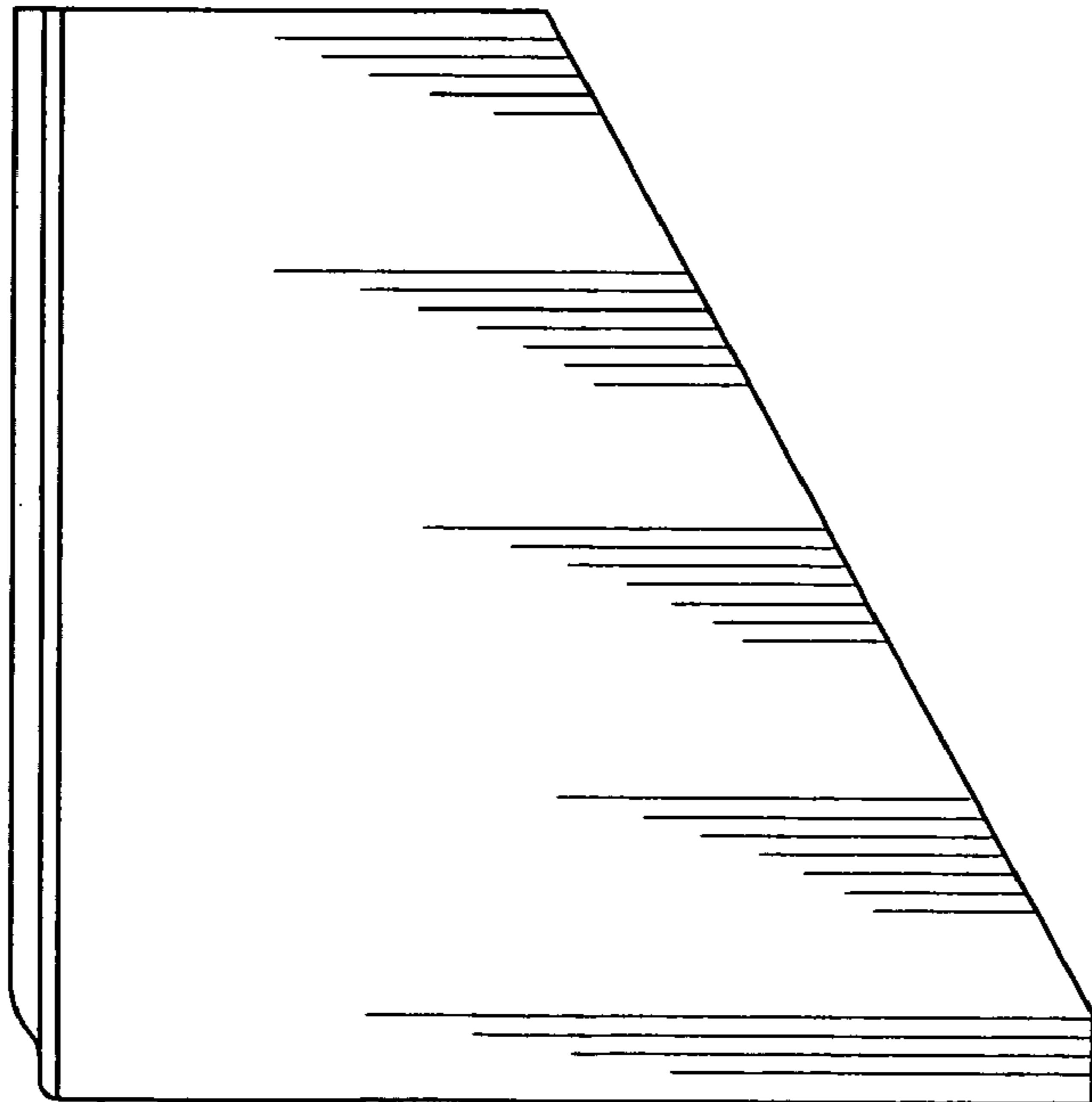
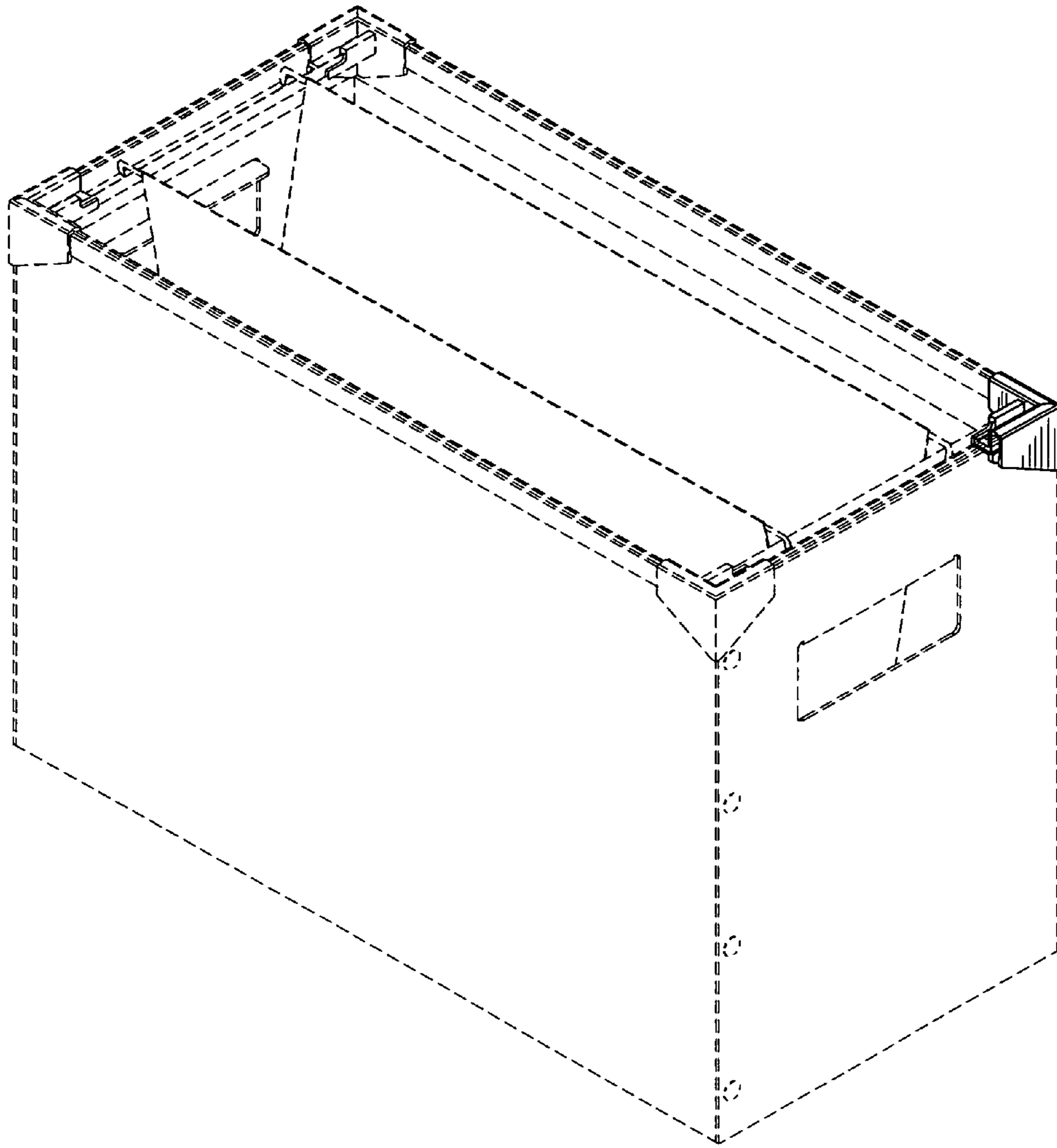

FIG. 6



F I G . 8