

US00D564706S

(12) **United States Design Patent**
Kadlubowski et al.

(10) **Patent No.:** **US D564,706 S**
(45) **Date of Patent:** **** Mar. 18, 2008**

(54) **COSMETIC CONTAINER**

(75) Inventors: **Bryan Michael Kadlubowski**,
Lebanon, OH (US); **Stacy Alycia**
Thomas, Chicago, IL (US)

(73) Assignee: **The Procter & Gamble Company**,
Cincinnati, OH (US)

(**) Term: **14 Years**

(21) Appl. No.: **29/269,913**

(22) Filed: **Dec. 11, 2006**

(51) **LOC (8) Cl.** **28-03**

(52) **U.S. Cl.** **D28/76; D9/504**

(58) **Field of Classification Search** D28/76,
D28/77, 85-90; 206/385, 823, 581; D9/503-505,
D9/529; 401/68-79; 132/317, 318, 320
See application file for complete search history.

(56) **References Cited**

U.S. PATENT DOCUMENTS

- D345,630 S * 3/1994 Chevassus D28/85
- D447,602 S * 9/2001 Dumler et al. D28/76
- D448,121 S * 9/2001 Gebb et al. D28/88
- D483,155 S * 12/2003 Orsomando D28/89
- D491,810 S * 6/2004 Kostow D9/504

- D513,815 S * 1/2006 Hollmann et al. D28/88
- D516,916 S * 3/2006 Cornet et al. D9/504
- D538,481 S * 3/2007 Decker D28/89
- D539,980 S * 4/2007 Kadlubowski et al. D28/76
- D539,981 S * 4/2007 Kadlubowski et al. D28/76

* cited by examiner

Primary Examiner—Jennifer Rivard

(74) *Attorney, Agent, or Firm*—Vladimir Vitenberg; Megan
A. Chorey; Brian M. Bolam

(57) **CLAIM**

The ornamental design for a cosmetic container, as shown
and described.

DESCRIPTION

FIG. 1 is a perspective front view of a cosmetic container,
embodying the new design;

FIG. 2 is a right side view of the design shown in FIG. 1;

FIG. 3 is a left side view of the design shown in FIG. 1;

FIG. 4 is a front view of the design shown in FIG. 1;

FIG. 5 is a back view of the design shown in FIG. 1;

FIG. 6 is a top view of the design shown in FIG. 1; and,

FIG. 7 is a bottom view of the design shown in FIG. 1.

1 Claim, 4 Drawing Sheets

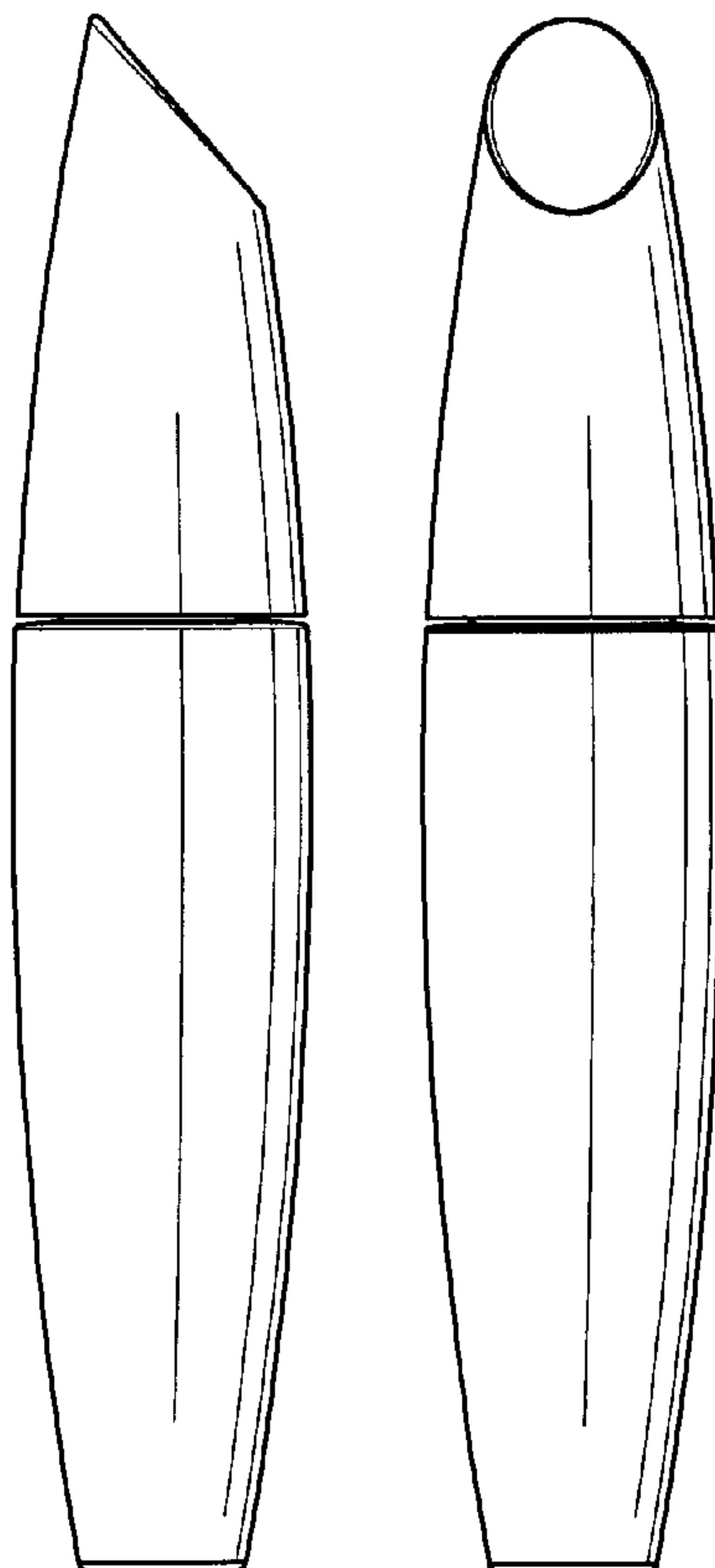

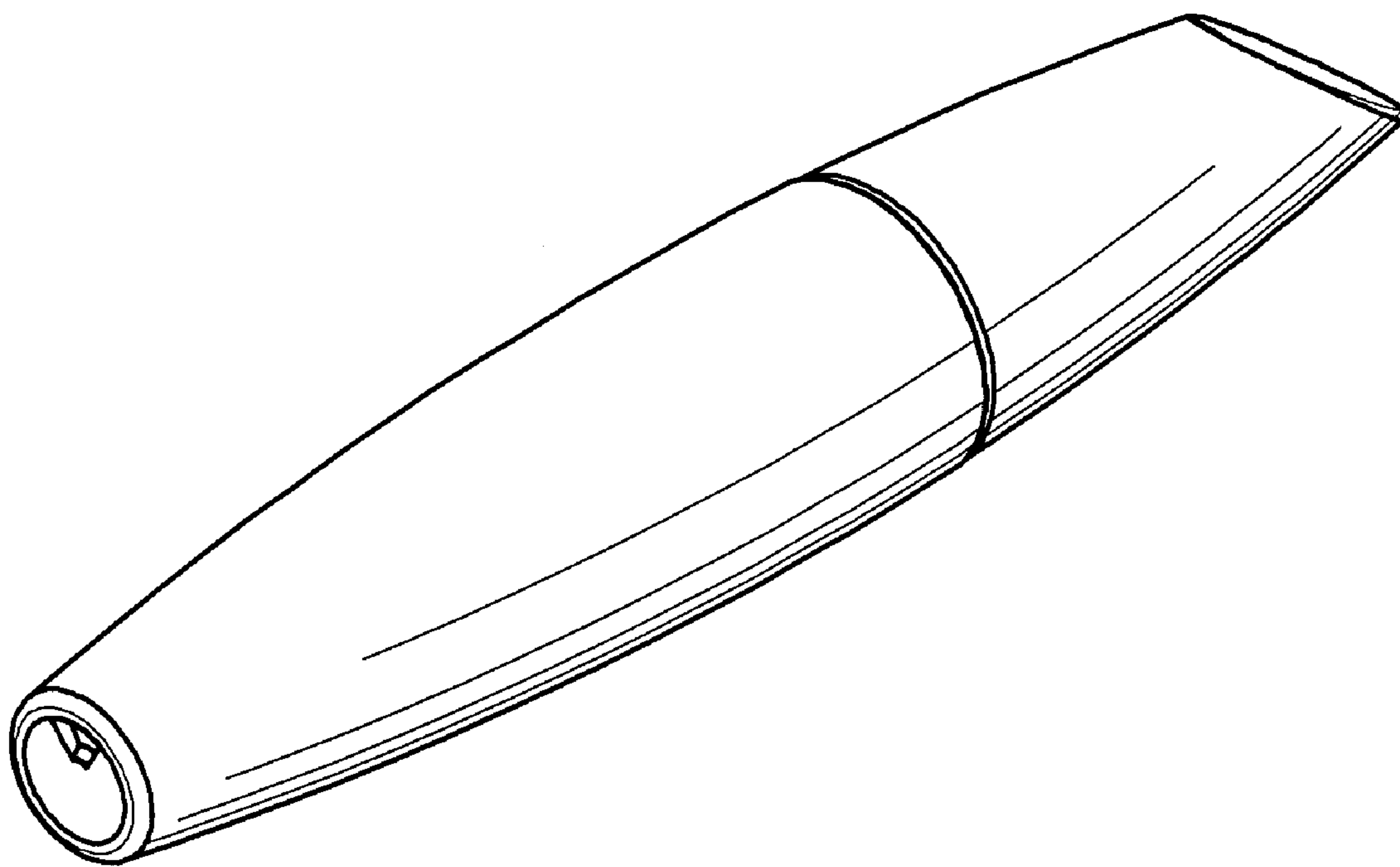

Fig. 1

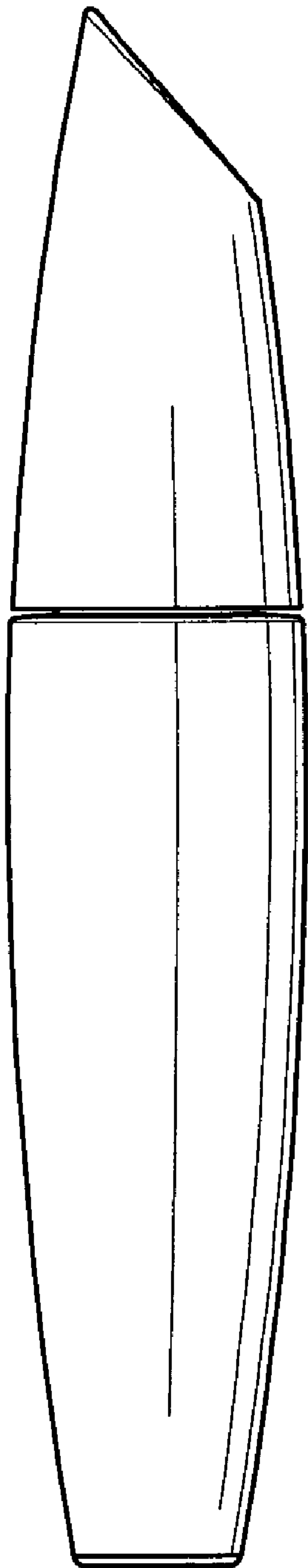

Fig. 2

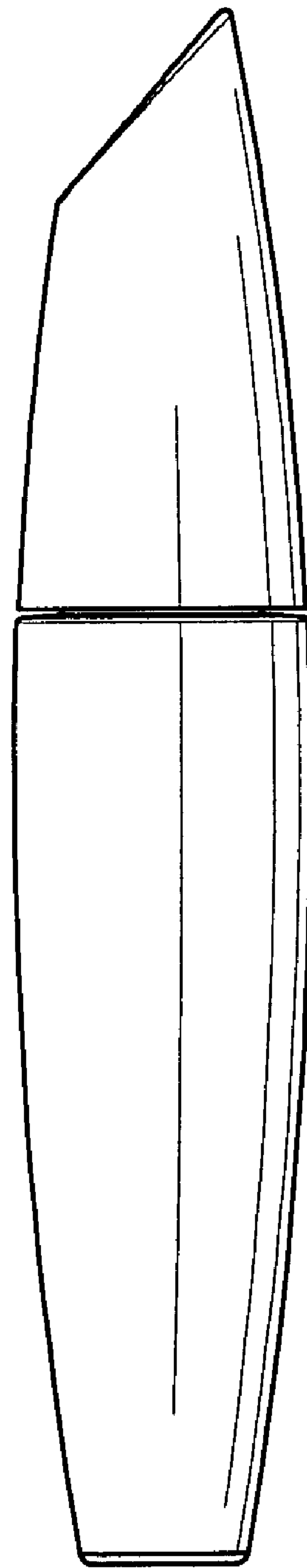

Fig. 3

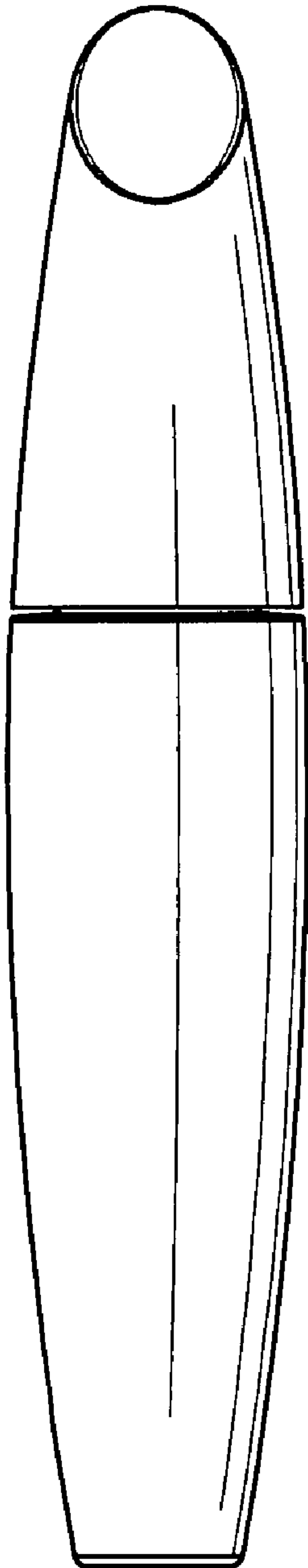

Fig. 4

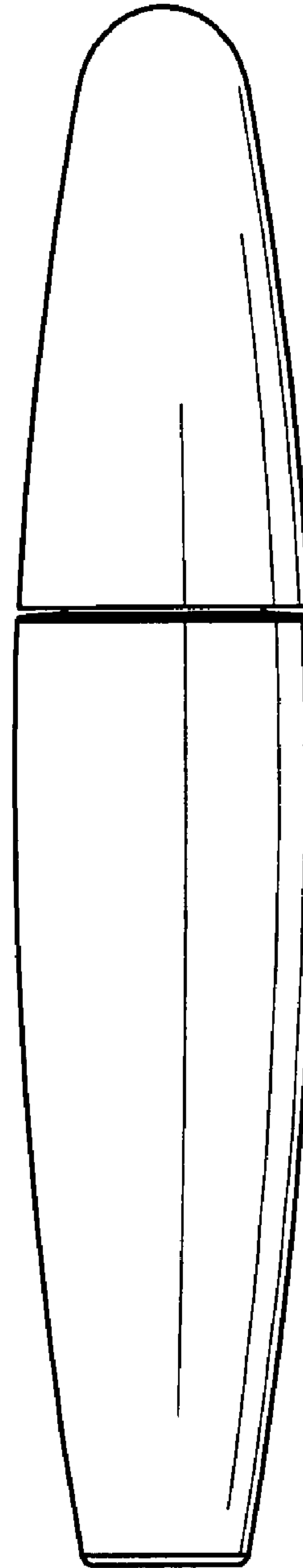

Fig. 5

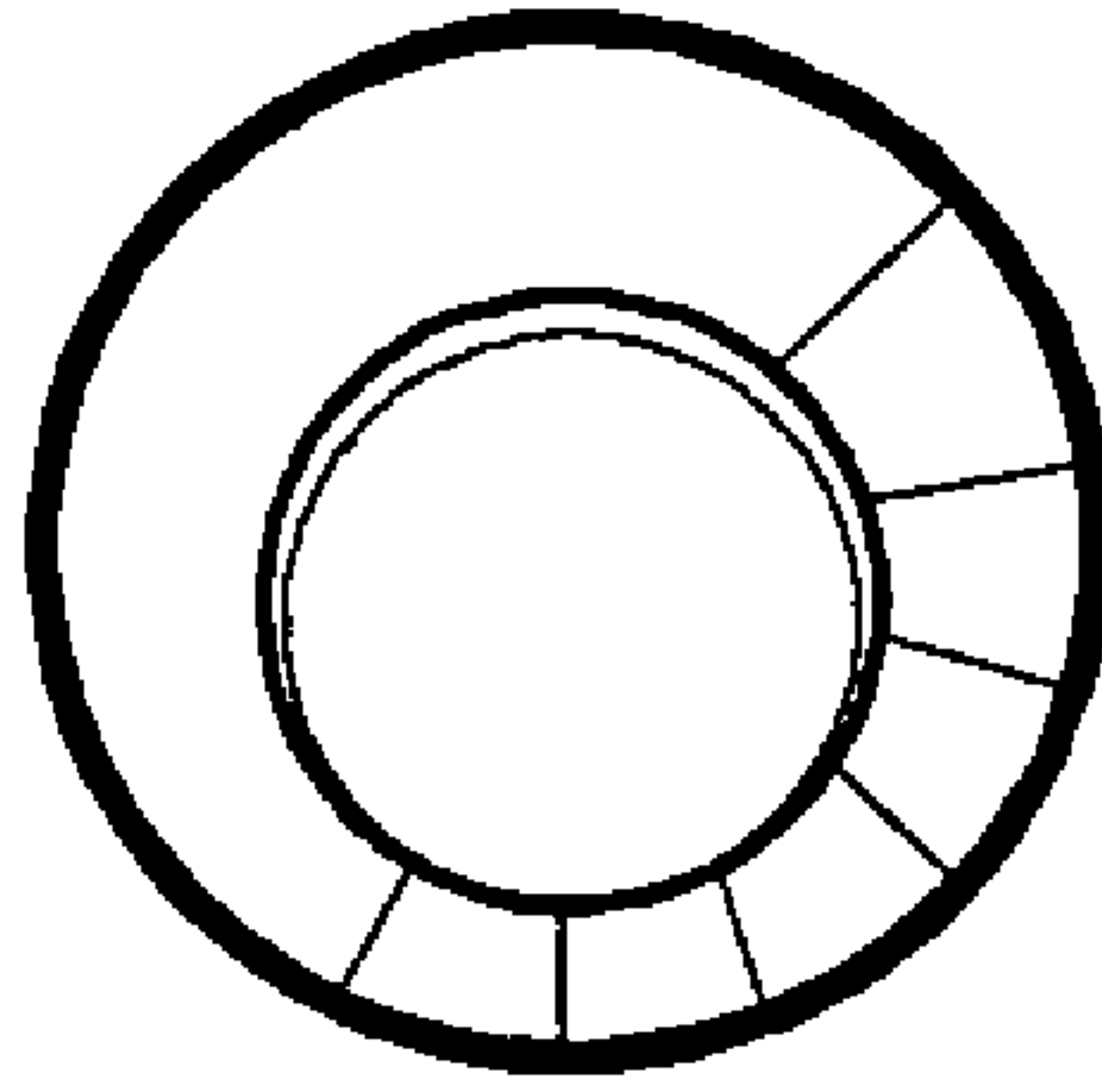

Fig. 6

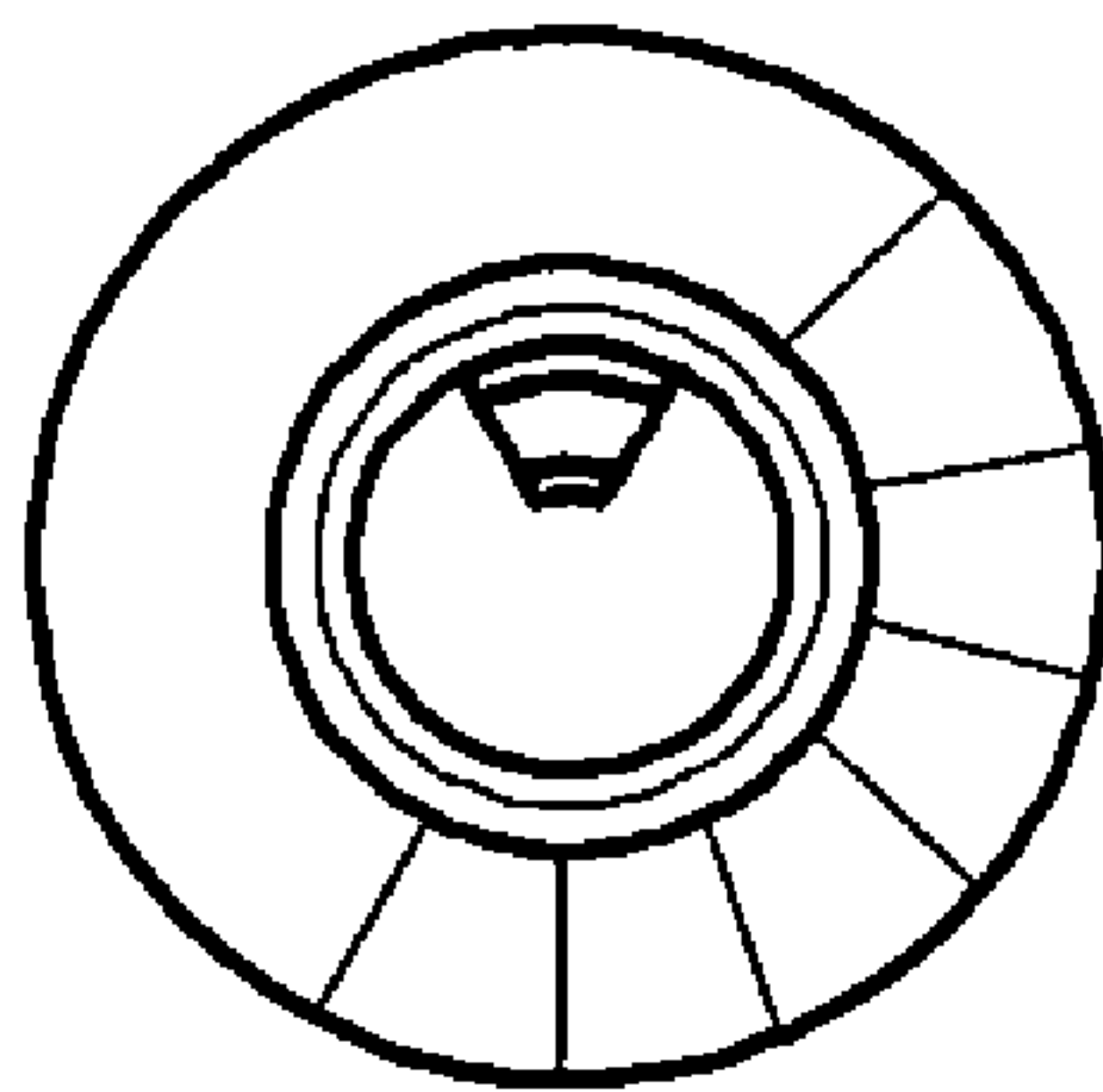

Fig. 7