



US00D564704S

(12) **United States Design Patent**
Chuang

(10) **Patent No.:** **US D564,704 S**

(45) **Date of Patent:** **** Mar. 18, 2008**

(54) **ASHTRAY**

D412,762 S * 8/1999 Miller D27/102
D415,852 S * 10/1999 Miller D27/102

(76) Inventor: **Shao-Chi Chuang**, No. 13, Alley 41,
Lane 8, Tianmu E. Rd., Shihlin District,
Taipei City 11153 (TW)

* cited by examiner

Primary Examiner—Jennifer Rivard
(74) *Attorney, Agent, or Firm*—Banger Shia

(**) Term: **14 Years**

(21) Appl. No.: **29/296,708**

(57) **CLAIM**

(22) Filed: **Oct. 25, 2007**

The ornamental design for an ashtray, as shown and described.

(51) **LOC (8) Cl.** **27-01**

DESCRIPTION

(52) **U.S. Cl.** **D27/103; D27/135**

(58) **Field of Classification Search** D27/102–108,
D27/135–136; 131/235.1–238, 240.1–242.6
See application file for complete search history.

FIG. 1 is a perspective view of a ashtray showing my new design;

FIG. 2 is a front elevational view thereof;

FIG. 3 is a rear elevational view thereof,

FIG. 4 is a left side elevational view thereof,

FIG. 5 is a right side elevational view thereof,

FIG. 6 is a top plan view thereof; and,

FIG. 7 is a bottom plan view to that shown.

(56) **References Cited**

U.S. PATENT DOCUMENTS

D117,898 S * 12/1939 Carawan D27/135
D205,172 S * 6/1966 Schetzer D27/102
D217,942 S * 6/1970 Angelakos D27/135
D387,473 S * 12/1997 Angelakos D27/135
5,873,370 A * 2/1999 Towle et al. 131/238

1 Claim, 5 Drawing Sheets

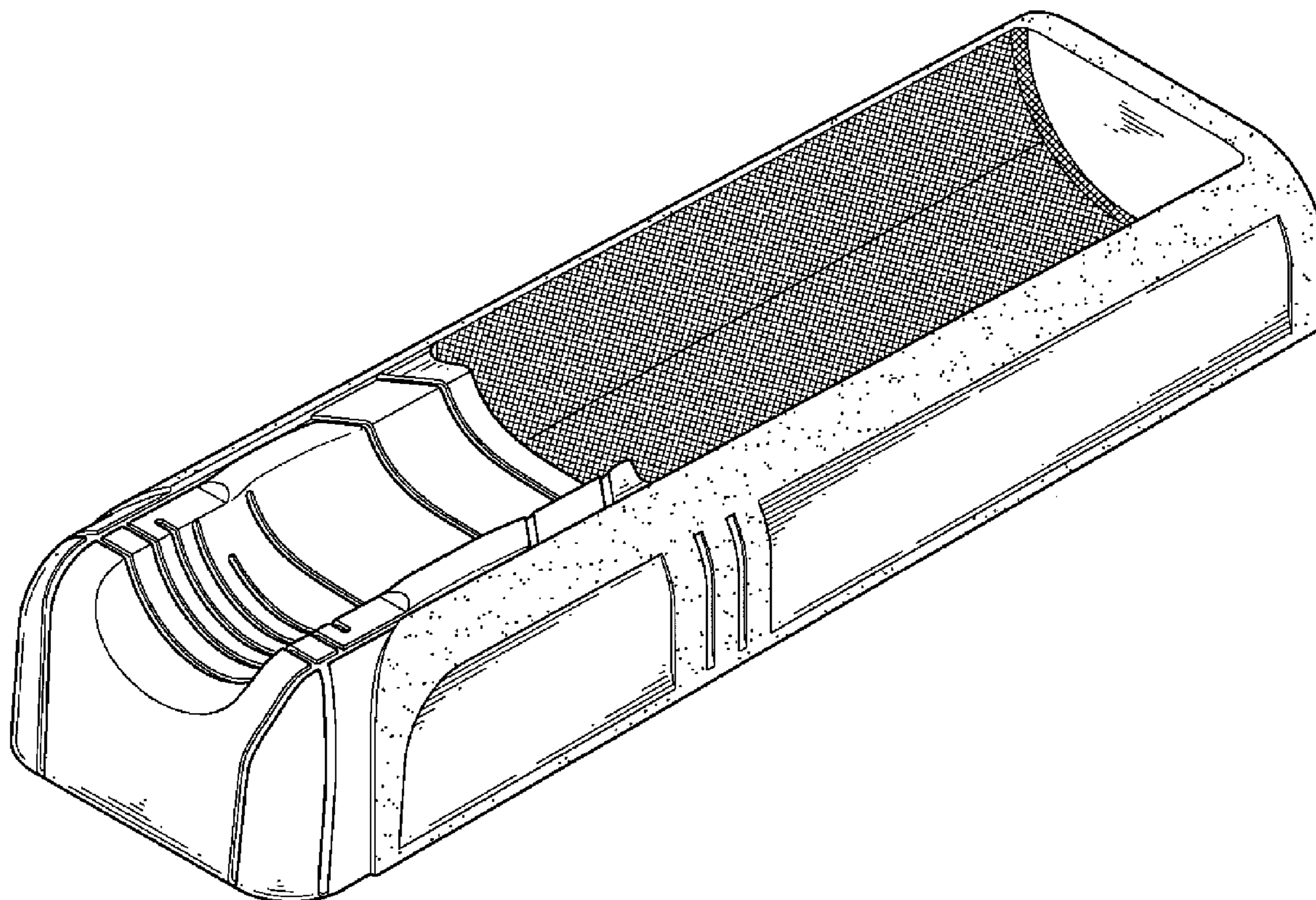

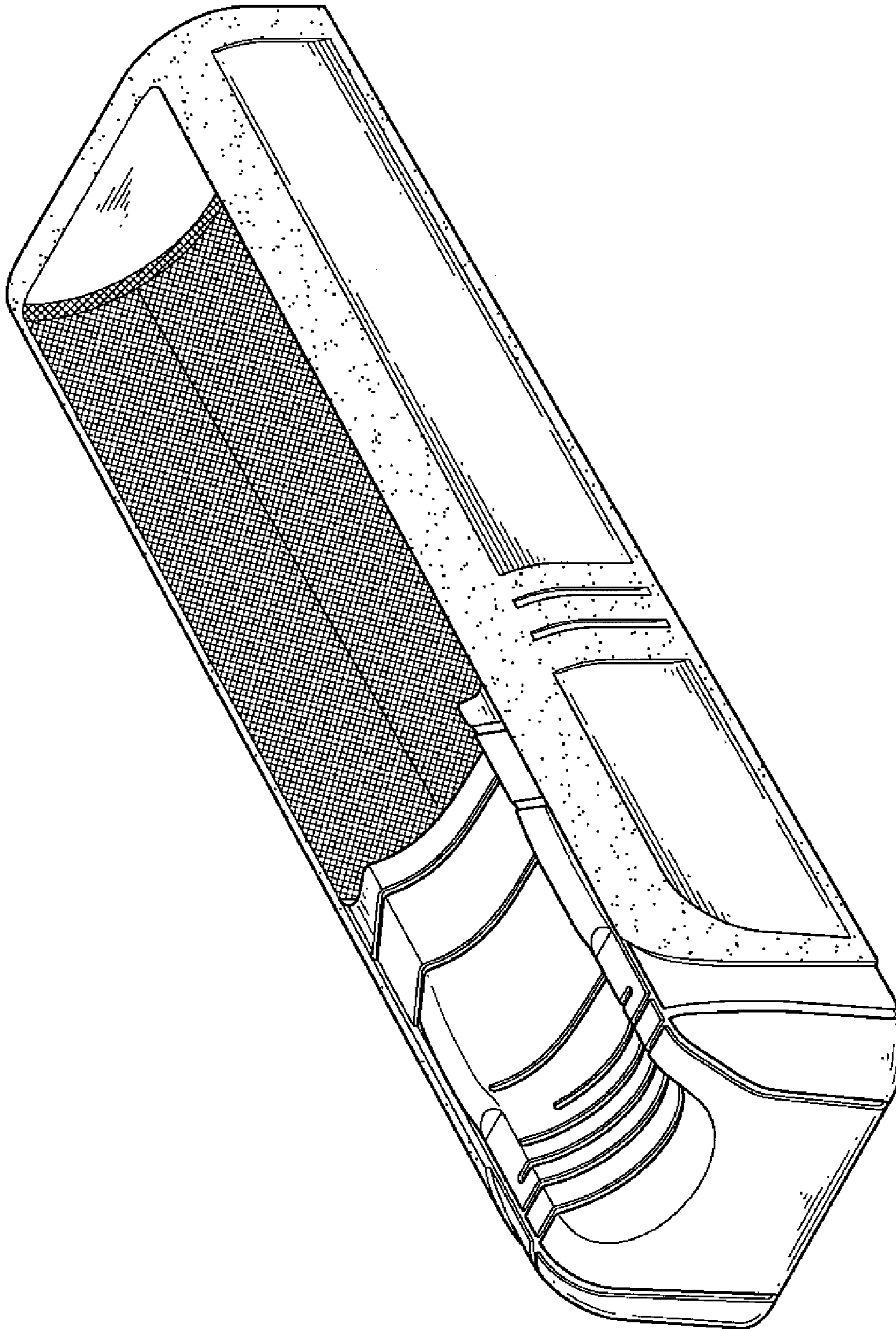

FIG. 1

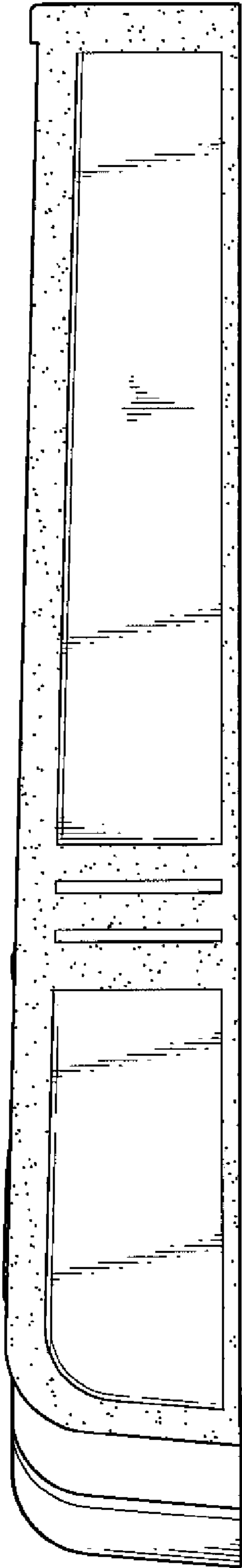

FIG. 2

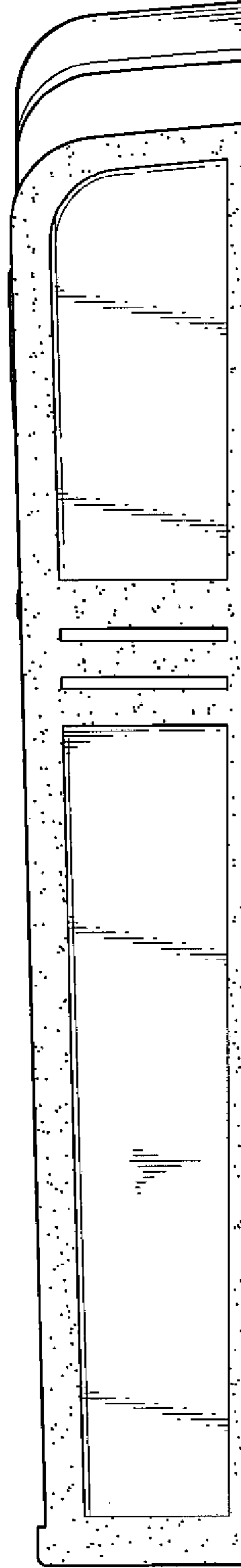

FIG. 3

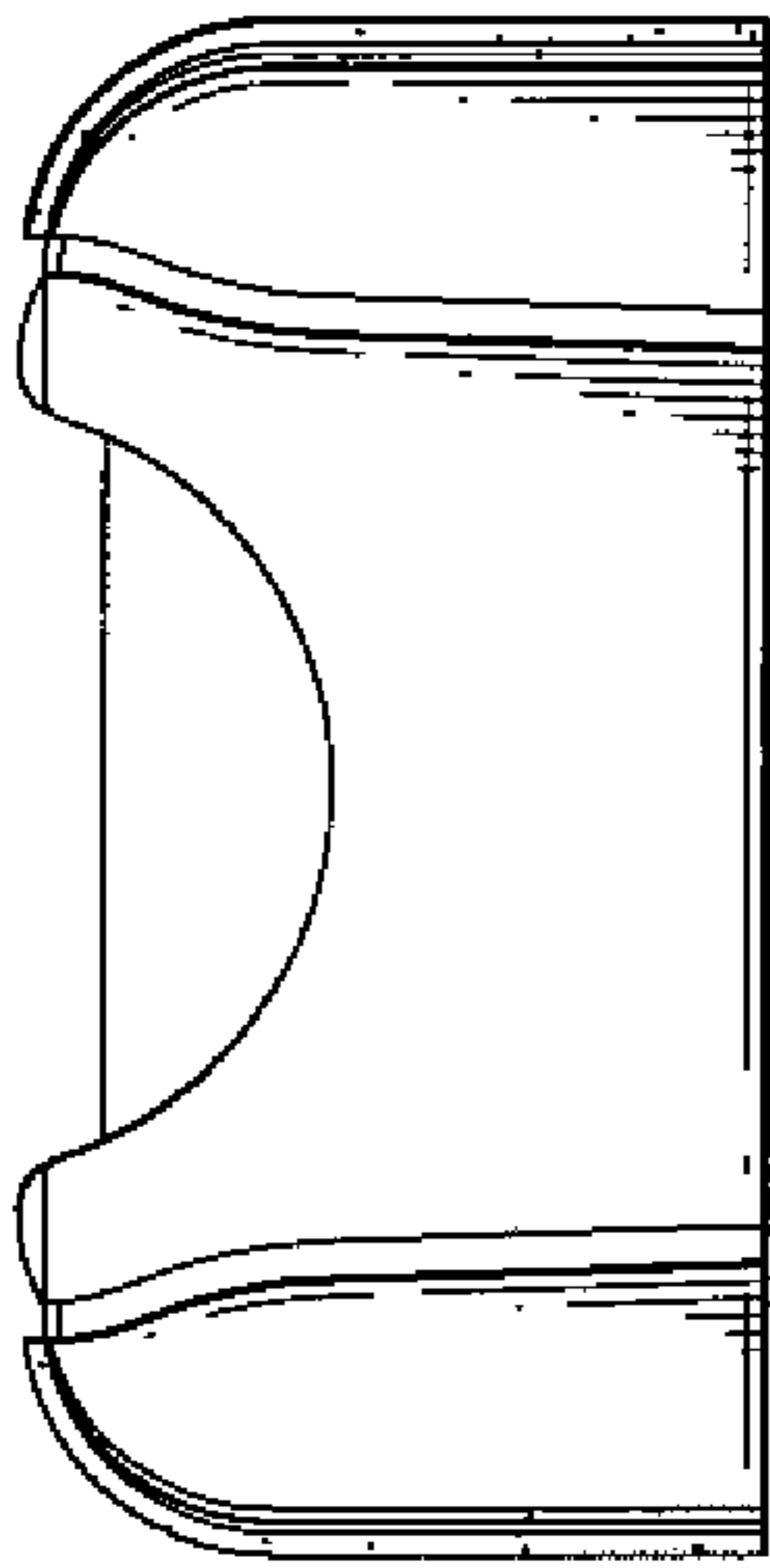

FIG. 4

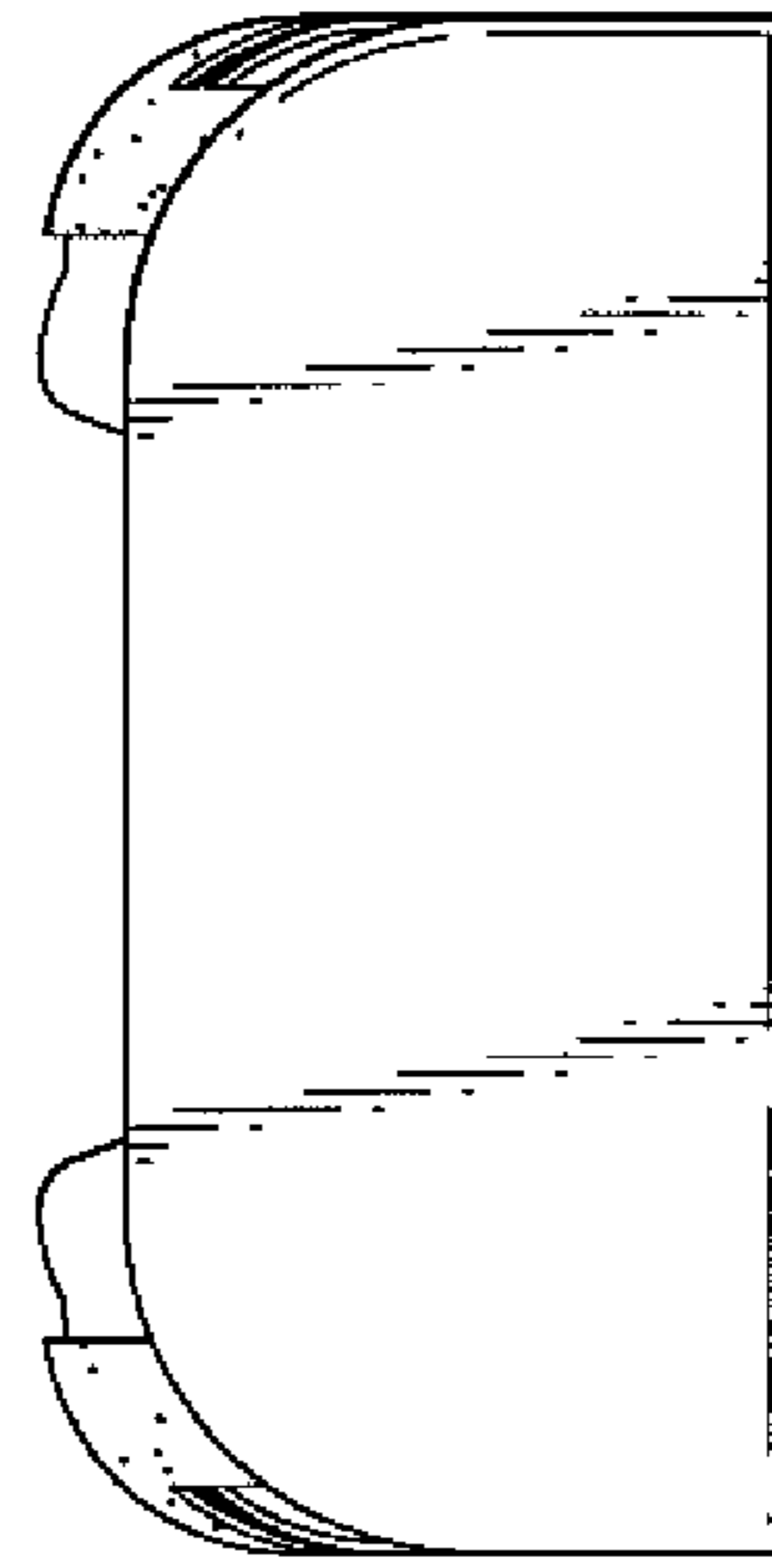

FIG. 5

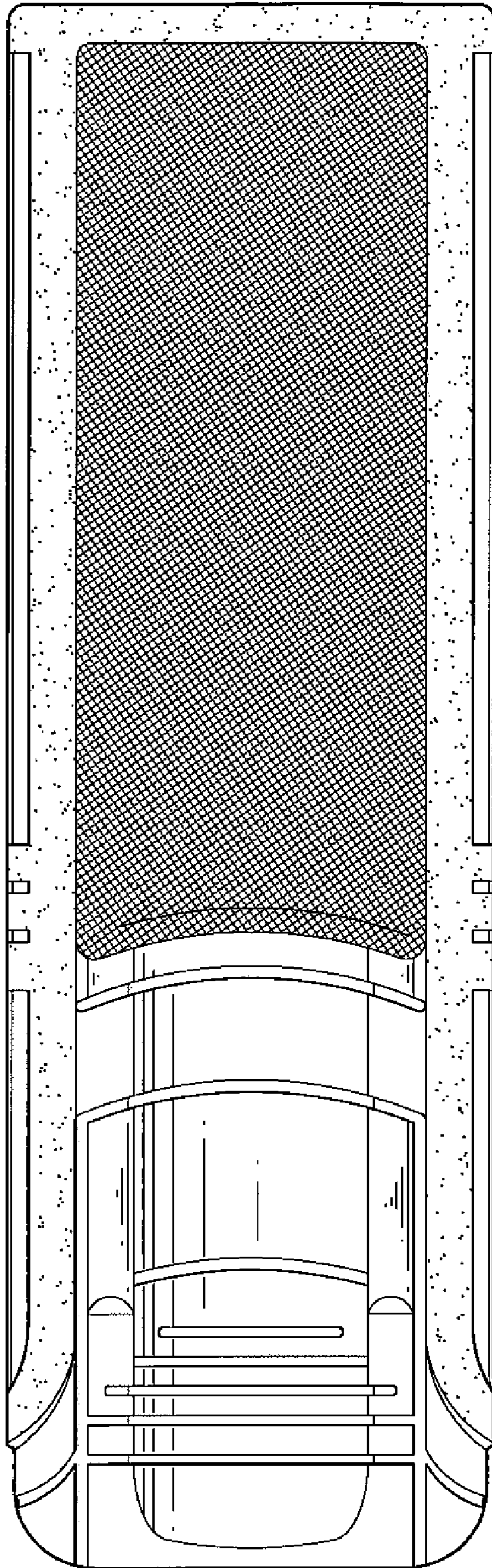

FIG. 6

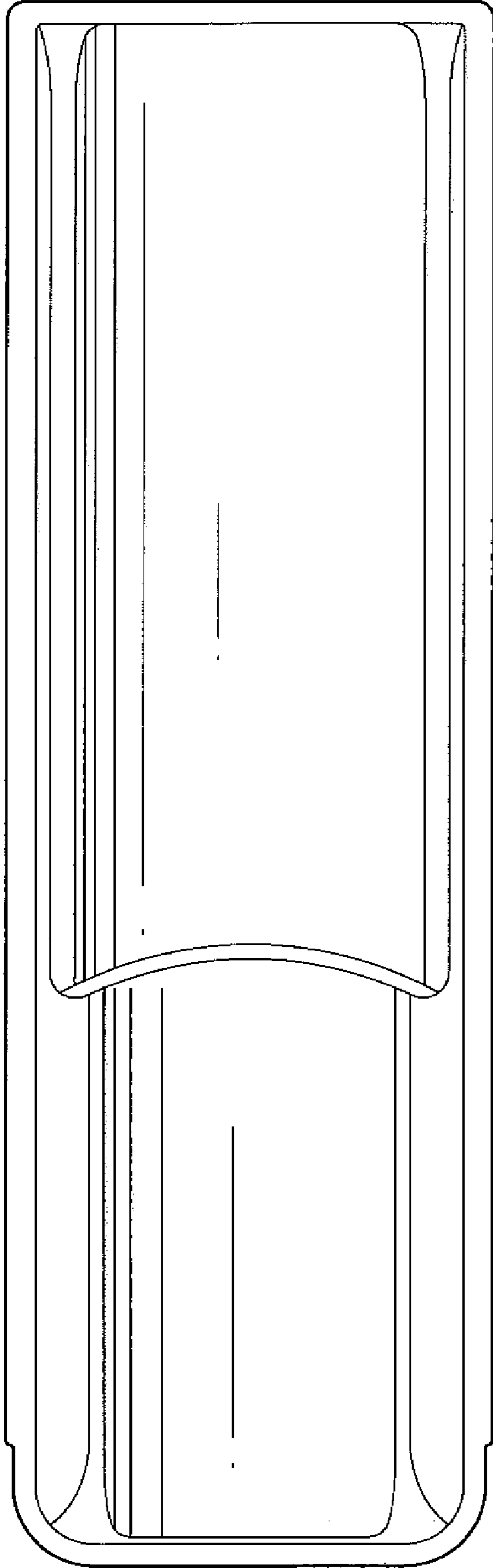

FIG. 7