



US00D564639S

(12) **United States Design Patent**
Bruce

(10) **Patent No.:** **US D564,639 S**

(45) **Date of Patent:** **** Mar. 18, 2008**

(54) **BATHTUB**

D511,819 S * 11/2005 Madson et al. D23/280.1
D527,083 S * 8/2006 Lebrun et al. D23/280.1

(75) Inventor: **Shawn Ian Bruce**, Los Angeles, CA
(US)

* cited by examiner

(73) Assignee: **Jason International, Inc.**, North Little
Rock, AR (US)

Primary Examiner—Robert A. Delehanty
(74) *Attorney, Agent, or Firm*—Banner & Witcoff, Ltd.

(**) Term: **14 Years**

(57) **CLAIM**

(21) Appl. No.: **29/278,029**

The ornamental design for a bathtub, as shown and described.

(22) Filed: **Mar. 16, 2007**

DESCRIPTION

(51) **LOC (8) Cl.** **23-02**

(52) **U.S. Cl.** **D23/280.1**

(58) **Field of Classification Search** D23/273,
D23/275–280.4, 304–306; D24/204–205;
4/538, 573.1, 584, 589, 591

See application file for complete search history.

FIG. 1 is a front view of a bathtub showing my new design;
FIG. 2 is a rear view thereof;
FIG. 3 is a right side view thereof;
FIG. 4 is a left side view thereof;
FIG. 5 is a top view thereof;
FIG. 6 is a bottom view thereof; and,
FIG. 7 is a perspective view thereof.

(56) **References Cited**

U.S. PATENT DOCUMENTS

505,041 A * 9/1893 Ferguson D23/280.1

1 Claim, 4 Drawing Sheets

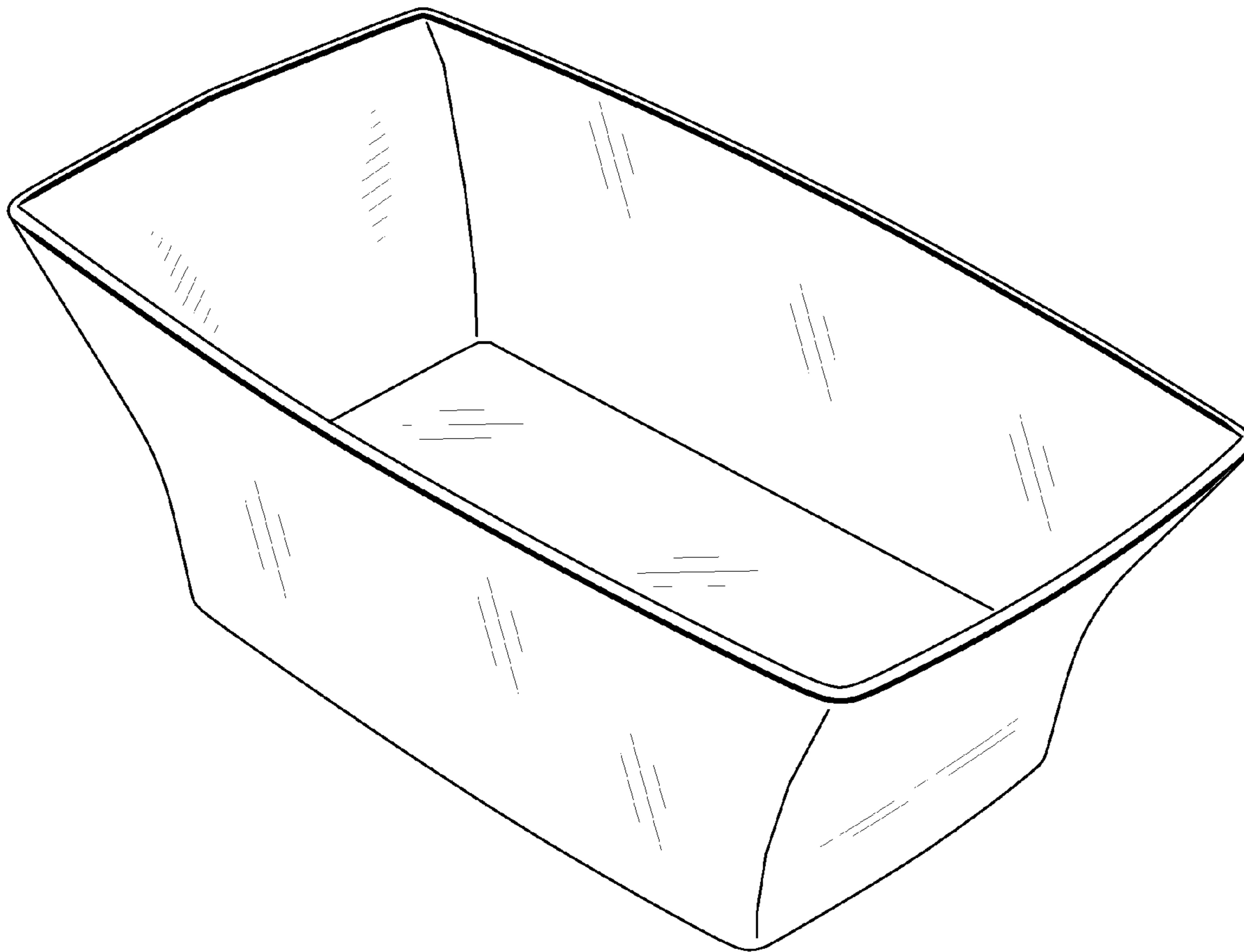

FIG. 1

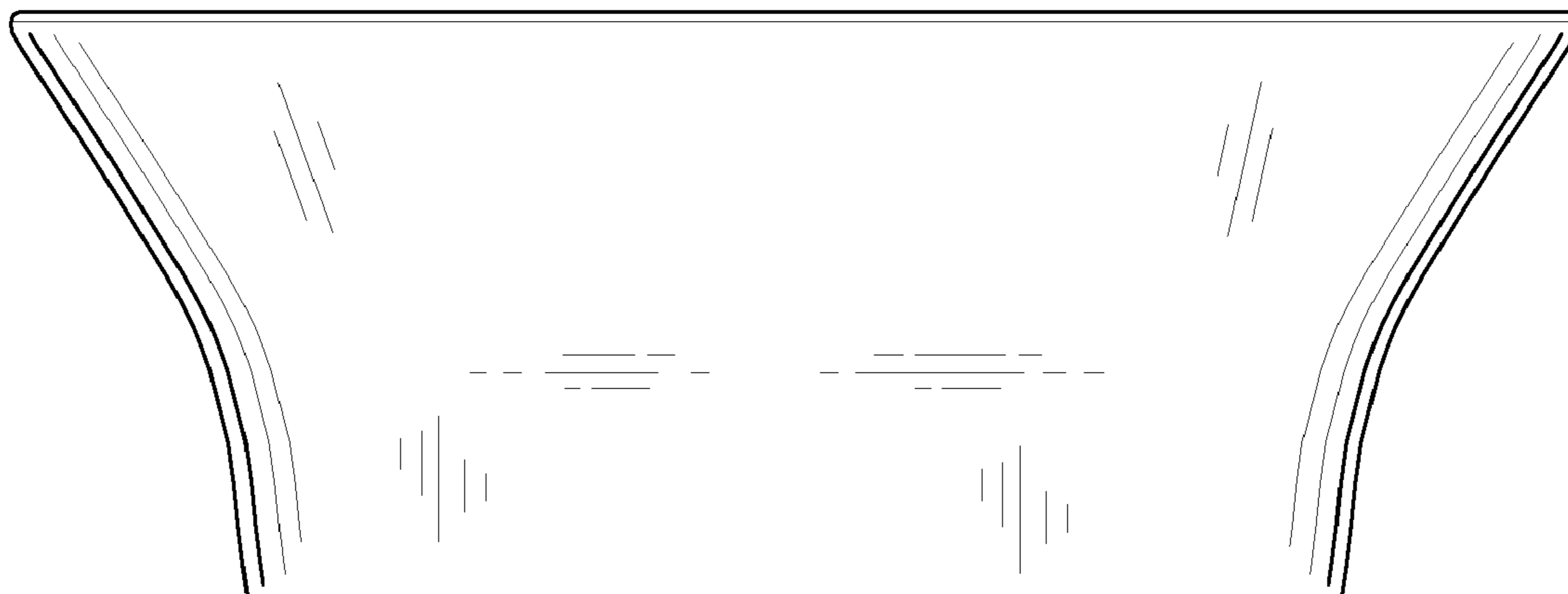

FIG. 2



FIG. 3

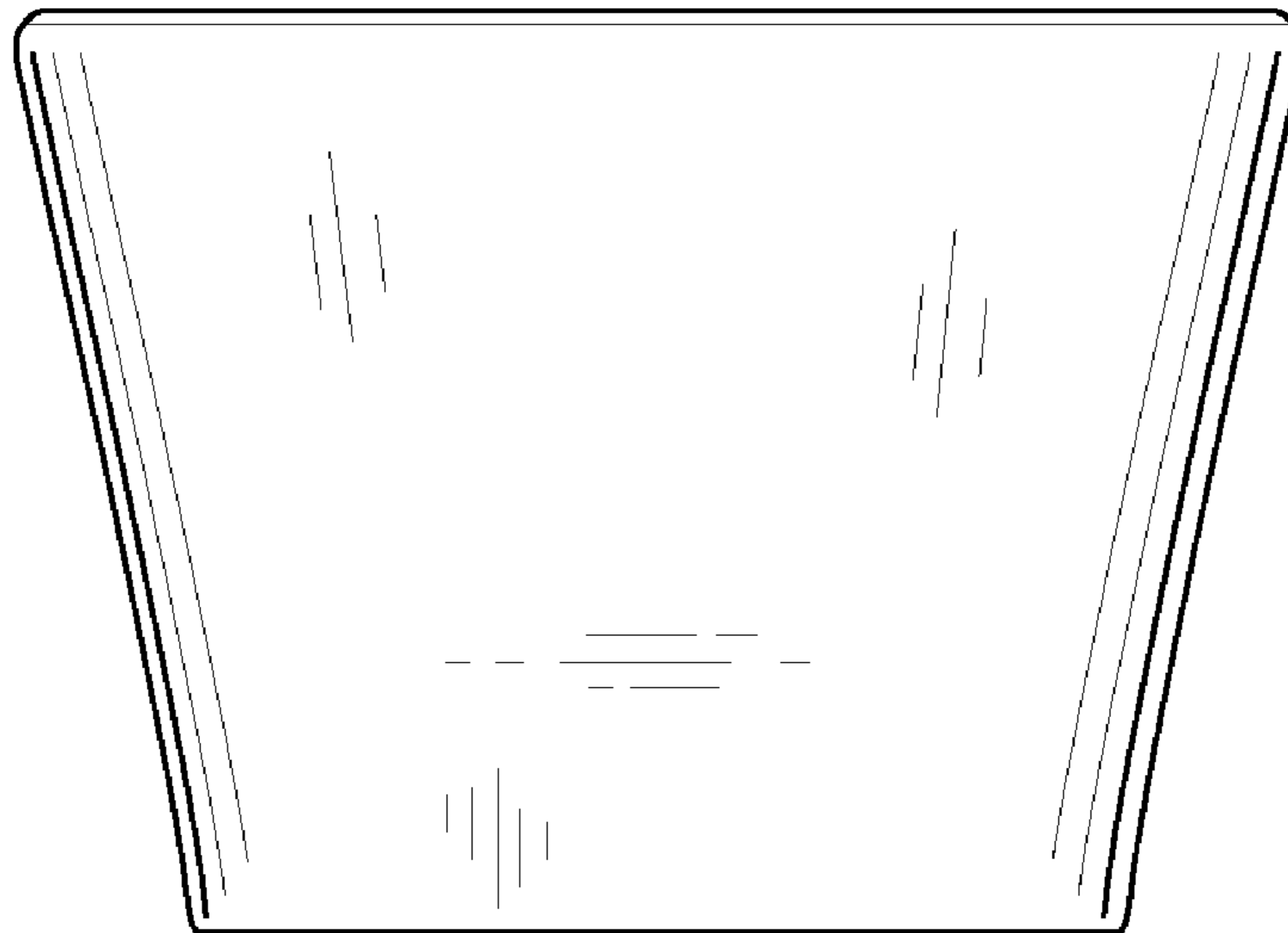

FIG. 4

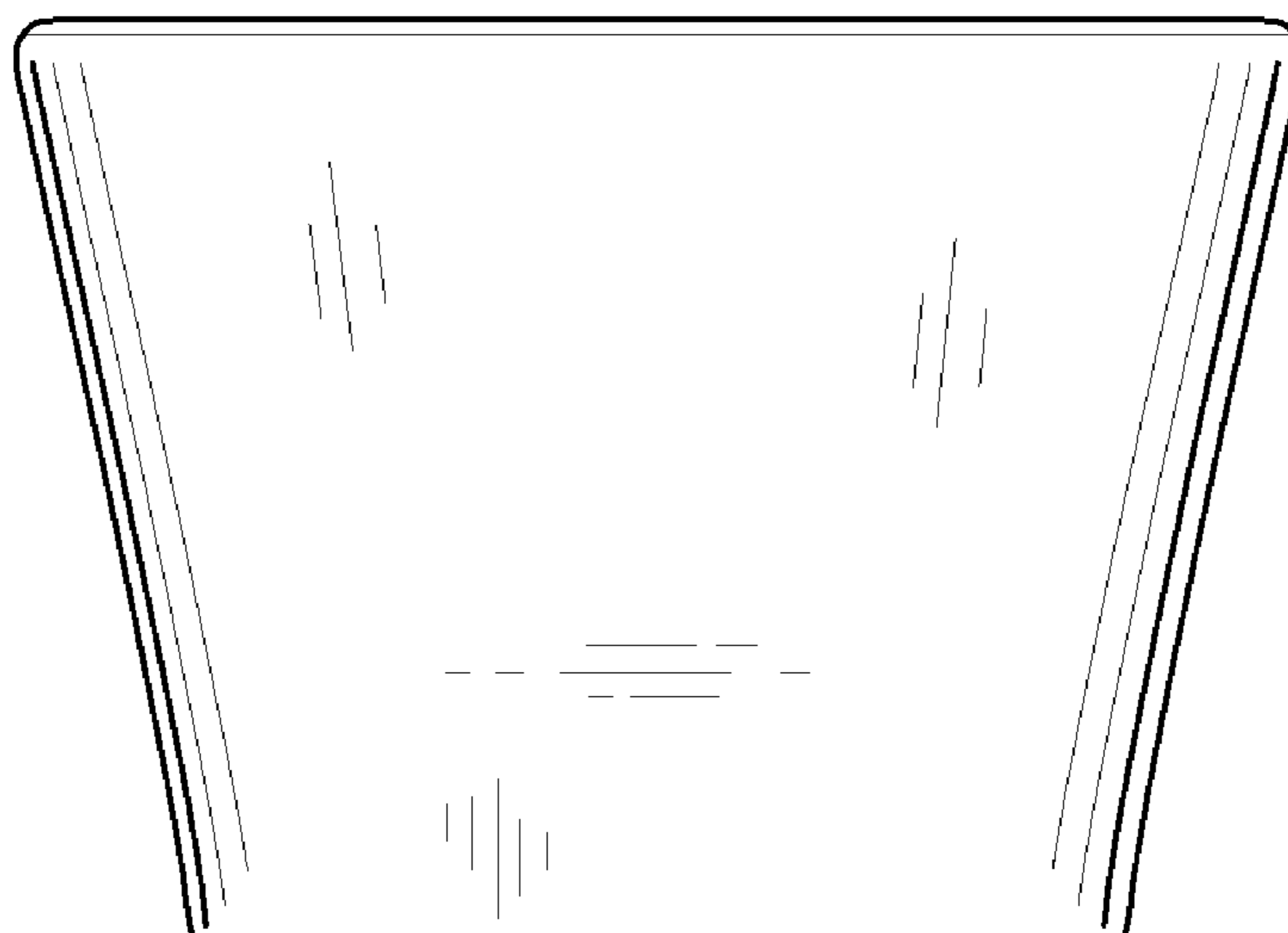

FIG. 5

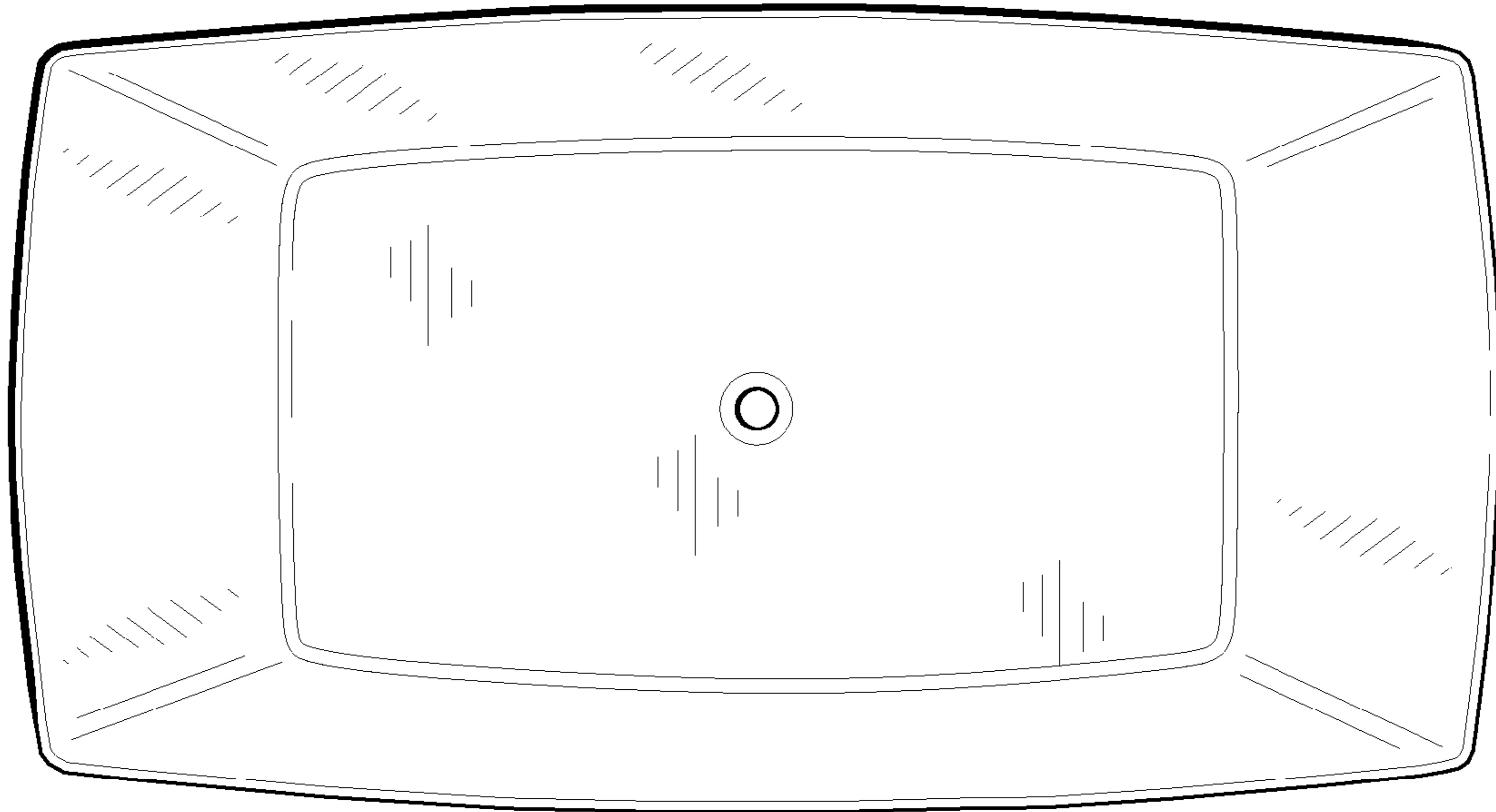
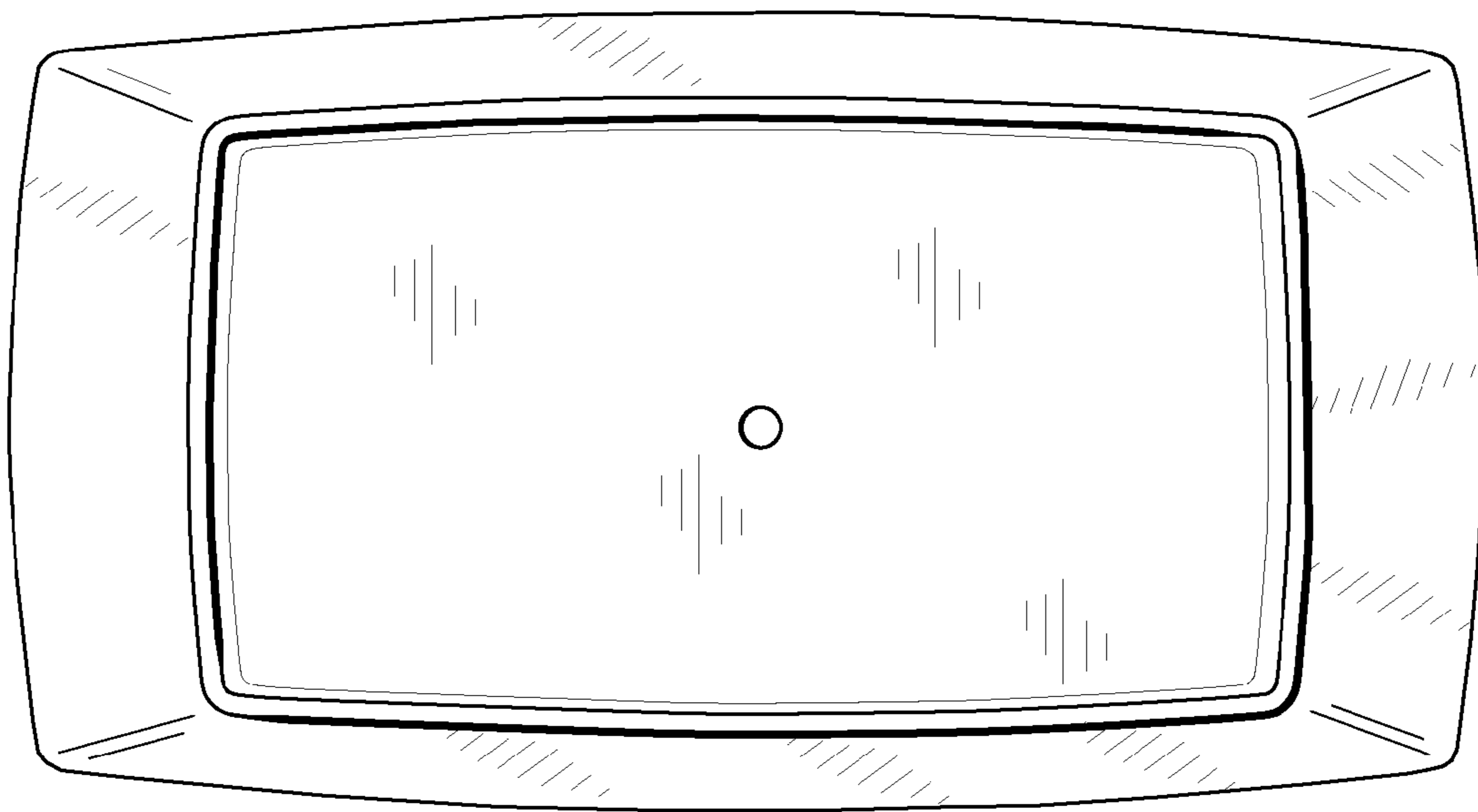

FIG. 6



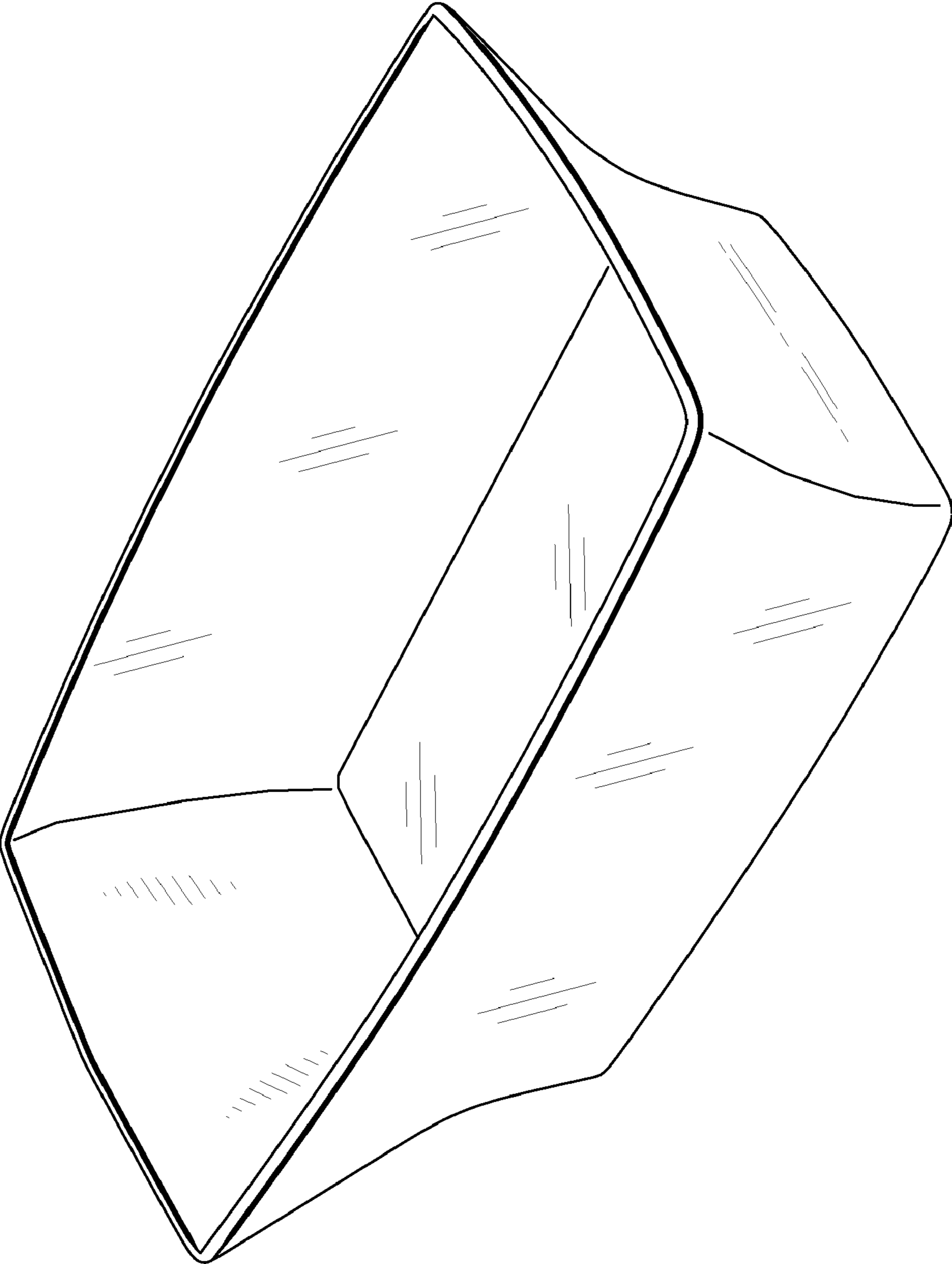

FIG. 7