

US00D564638S

(12) **United States Design Patent**
Cunningham

(10) **Patent No.:** **US D564,638 S**

(45) **Date of Patent:** **** Mar. 18, 2008**

(54) **BATHTUB**

(75) **Inventor:** **Jeffrey L. Cunningham**, Cabot, AR (US)

(73) **Assignee:** **Jason International, Inc.**, North Little Rock, AR (US)

(**) **Term:** **14 Years**

(21) **Appl. No.:** **29/278,027**

(22) **Filed:** **Mar. 16, 2007**

(51) **LOC (8) Cl.** **23-02**

(52) **U.S. Cl.** **D23/280.1; D24/204**

(58) **Field of Classification Search** **D23/273, D23/275-280.4, 304-306; D24/204-205; 4/538, 573.1, 584, 589, 591**

See application file for complete search history.

(56) **References Cited**

U.S. PATENT DOCUMENTS

D446,574 S * 8/2001 Thomas et al. D23/280.1
6,360,380 B1 * 3/2002 Swart et al. 4/584

* cited by examiner

Primary Examiner—Robert A. Delehanty

(74) *Attorney, Agent, or Firm*—Banner & Witcoff, Ltd.

(57) **CLAIM**

The ornamental design for a bathtub, as shown and described.

DESCRIPTION

FIG. 1 is a top view of a bathtub showing my new design; FIG. 2 is a right side view thereof; FIG. 3 is a left side view thereof; FIG. 4 is a front view thereof; FIG. 5 is a rear view thereof; and, FIG. 6 is a perspective view thereof.

The broken line showing of the remainder of the bathtub is for illustrative purposes only and forms no part of the claimed design.

1 Claim, 4 Drawing Sheets

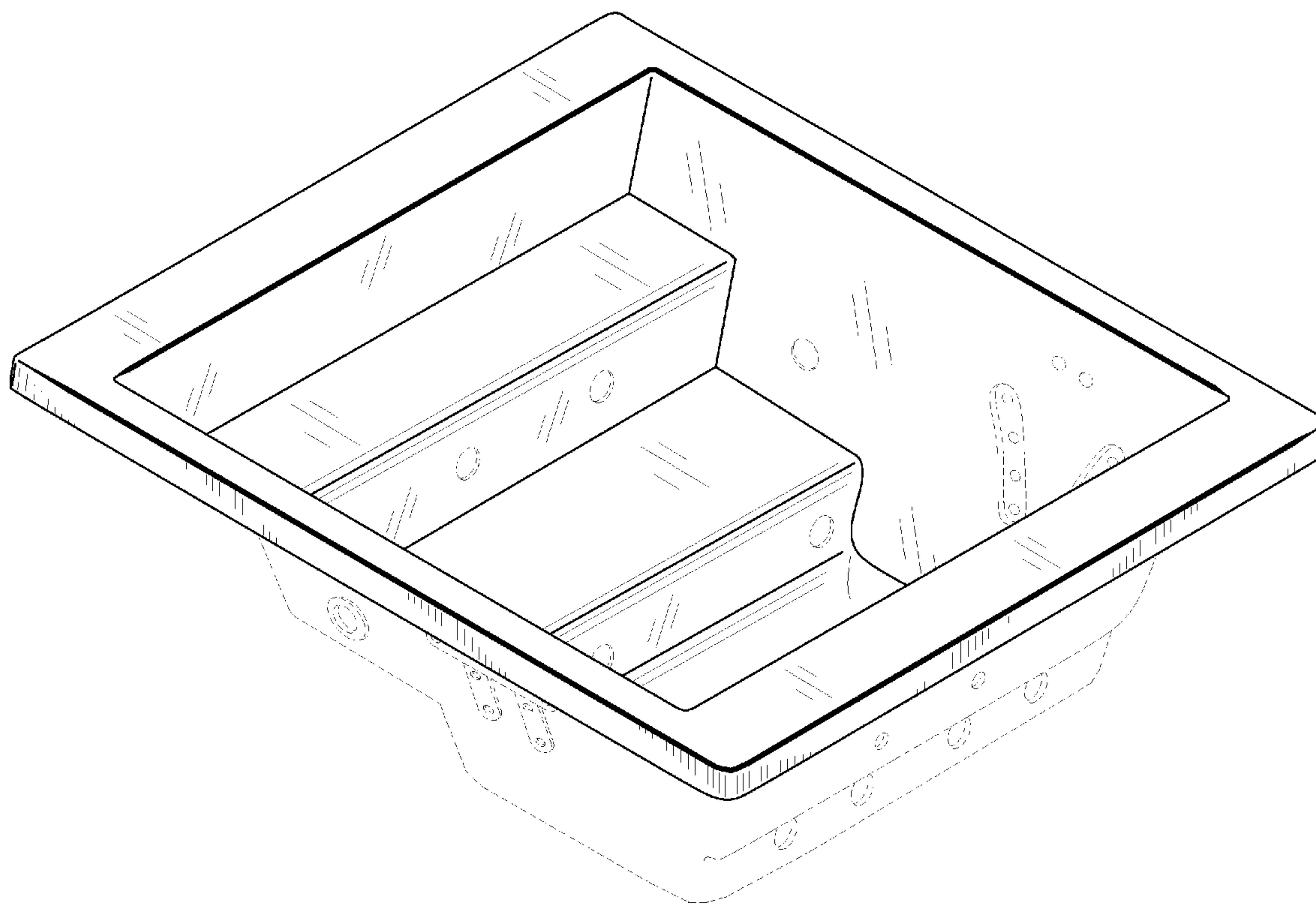

FIG. 1

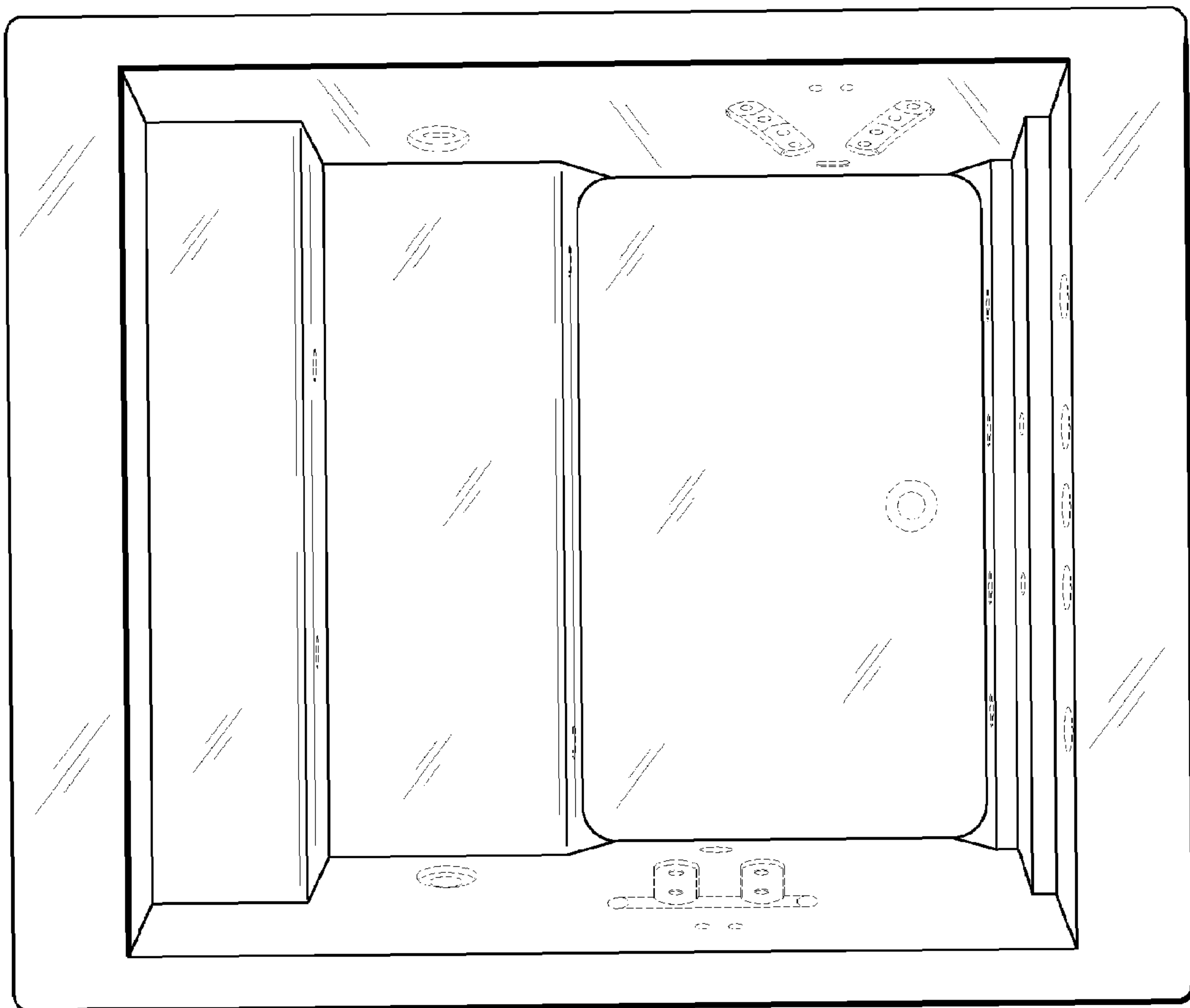

FIG. 2

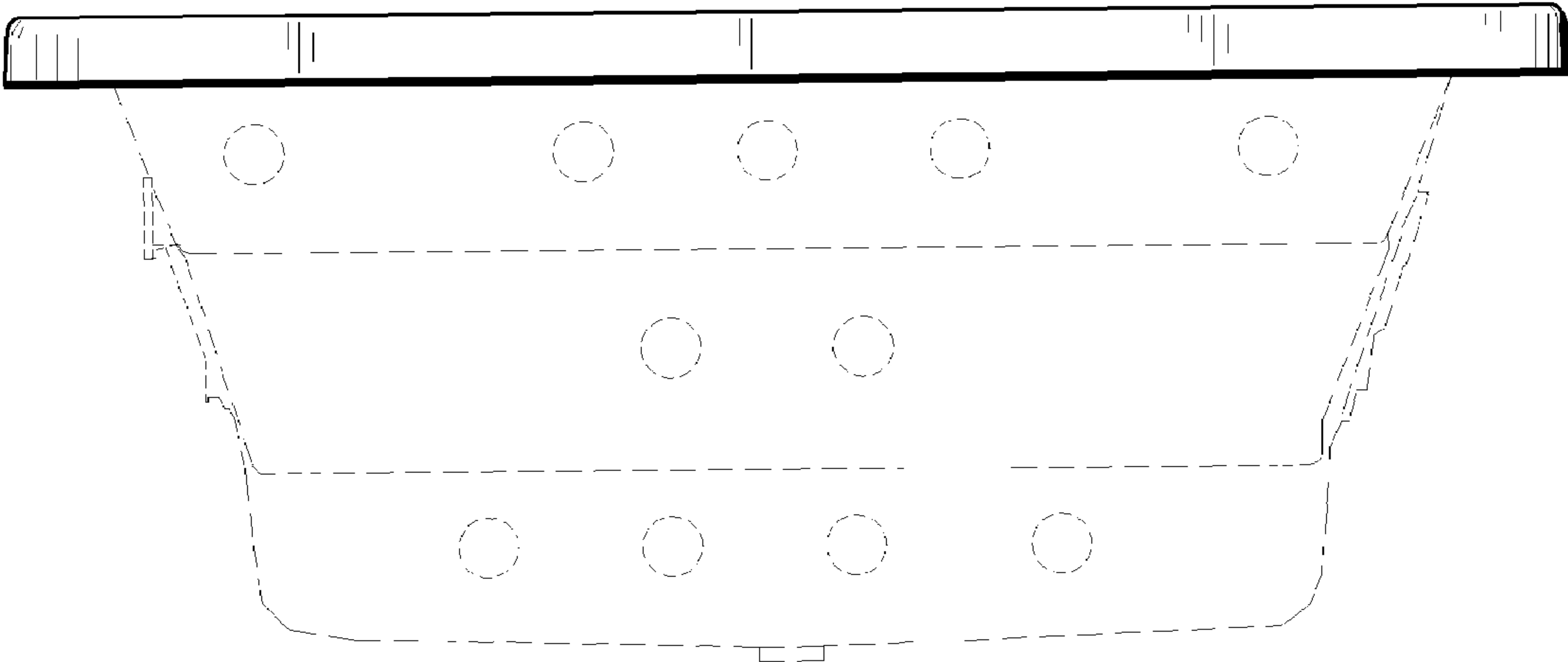

FIG. 3

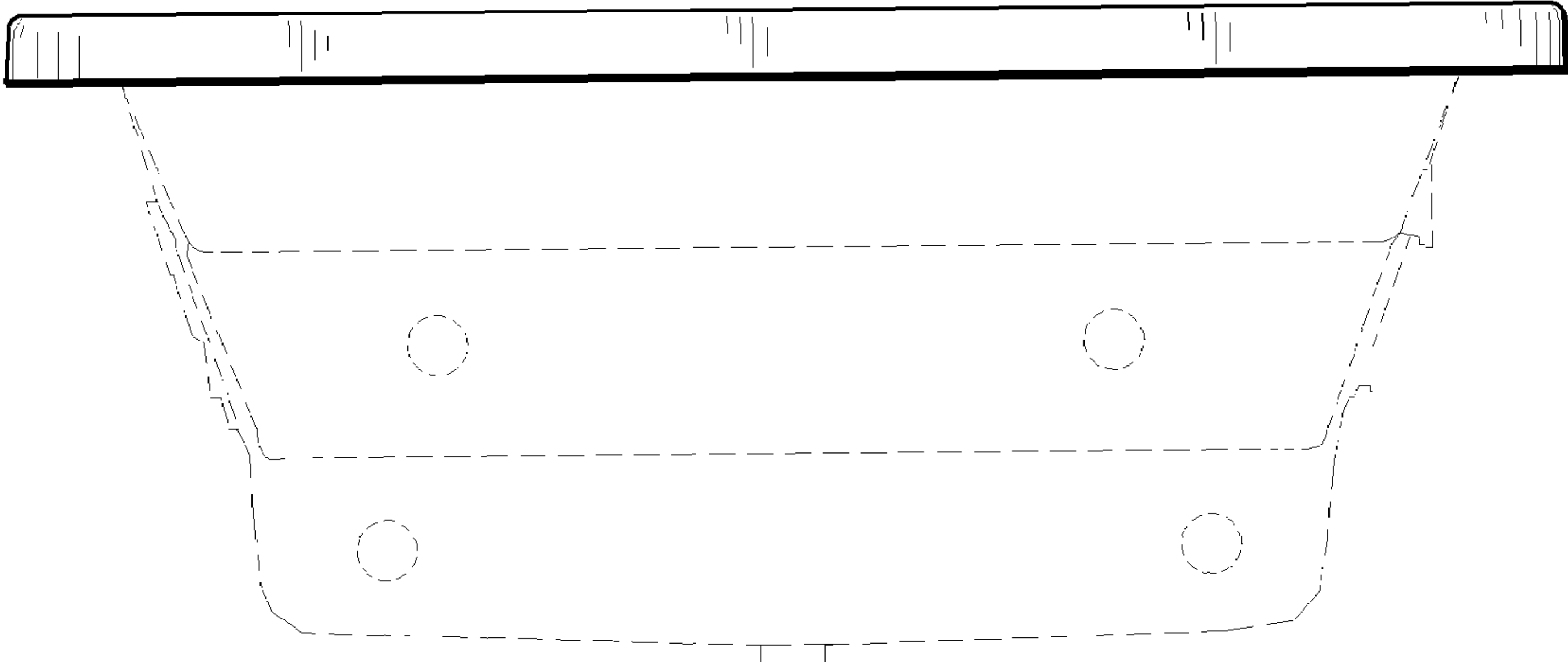

FIG. 4

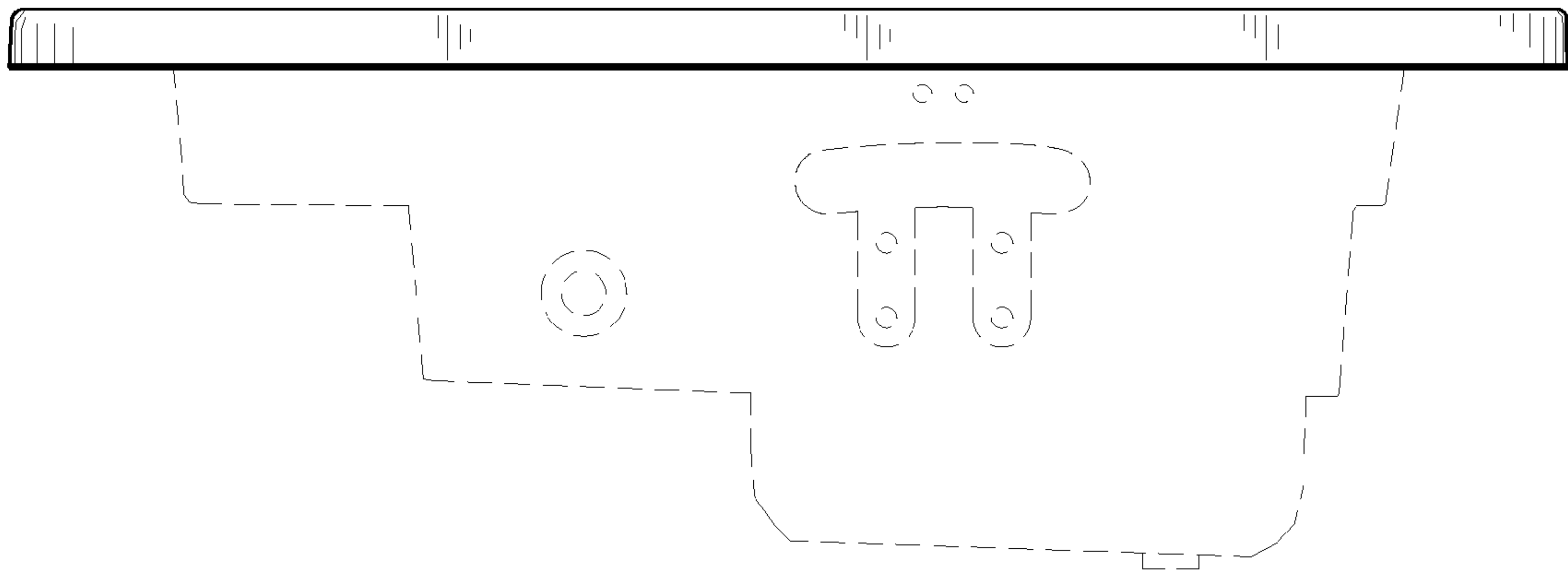
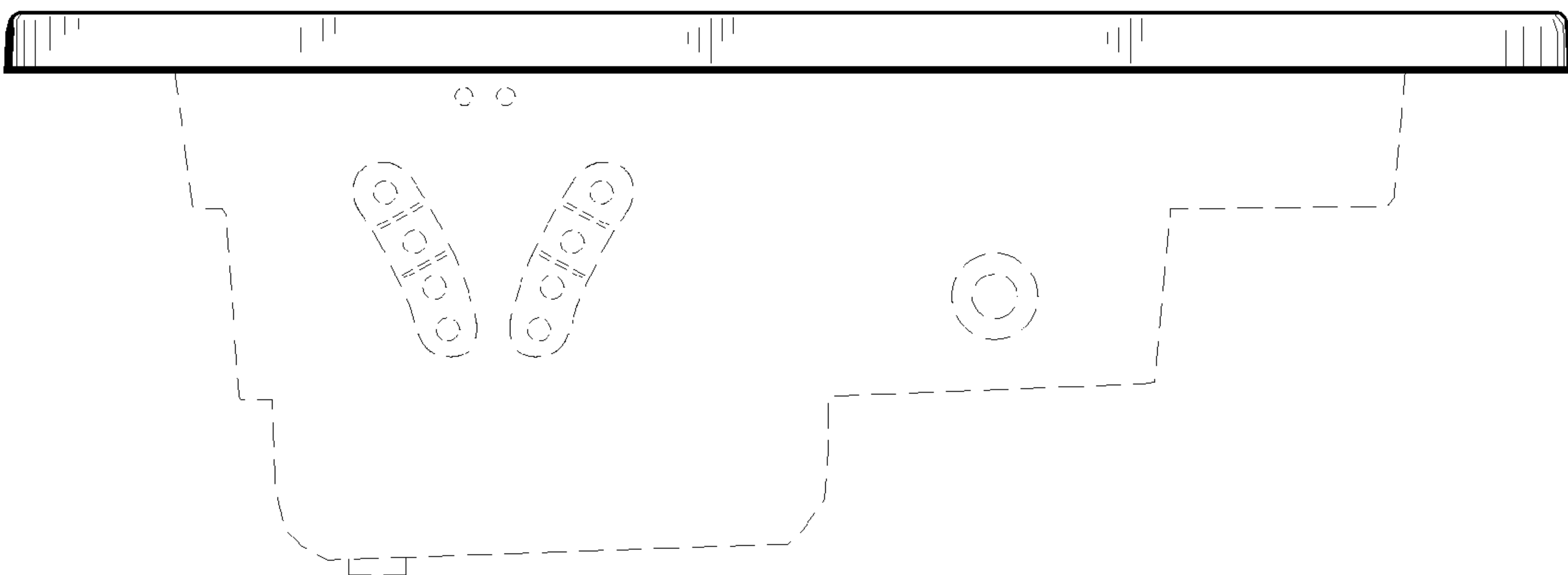

FIG. 5



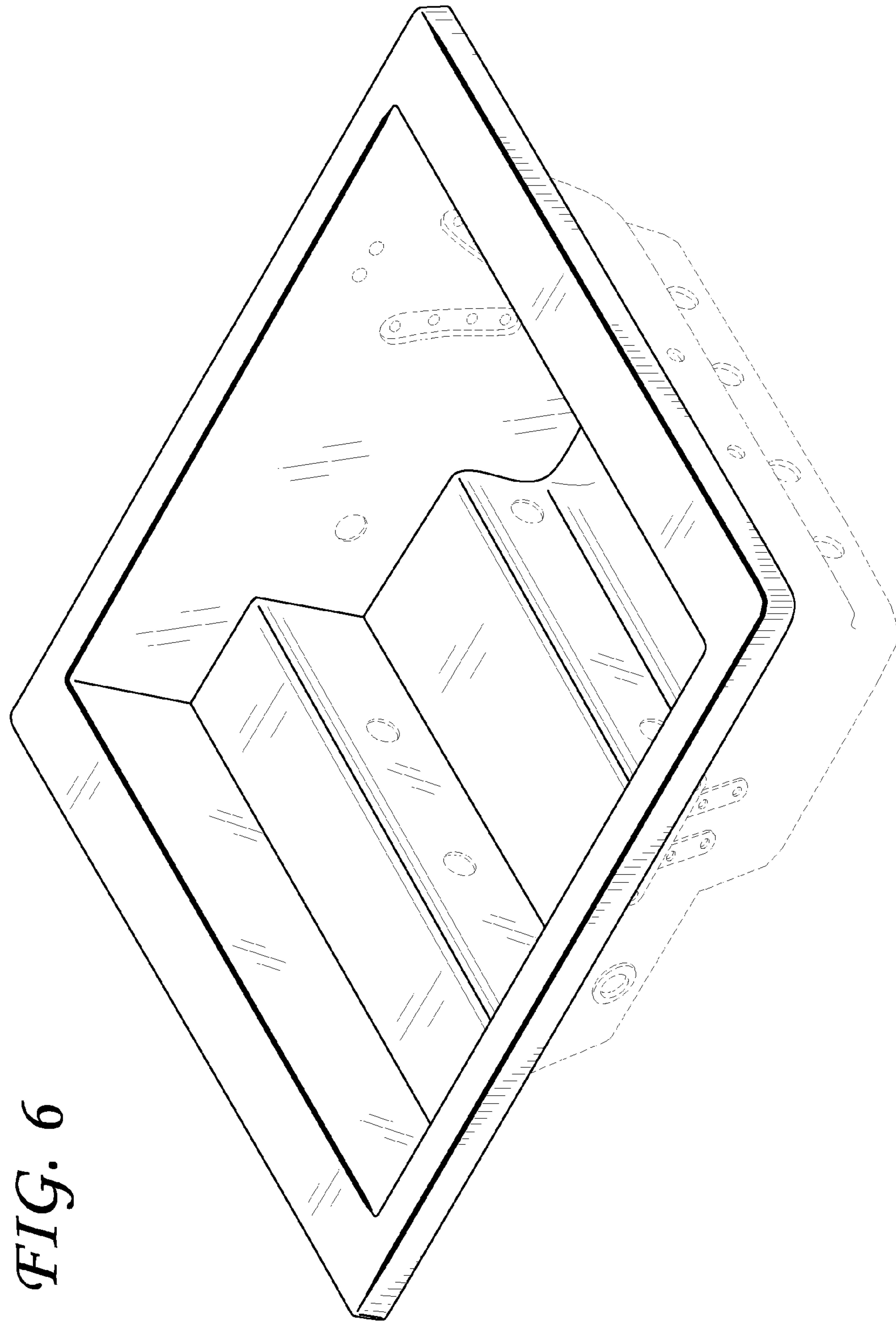

FIG. 6