



US00D564623S

(12) **United States Design Patent**  
**Nathan et al.**

(10) **Patent No.:** **US D564,623 S**  
(45) **Date of Patent:** **\*\* Mar. 18, 2008**

(54) **CUP PAINT GUN**

(75) Inventors: **Philip Nathan**, West Hartford, CT  
(US); **Robert H. Bruno**, Avon, CT  
(US)

(73) Assignee: **Wagner Spray Tech Corporation**,  
Plymouth, MN (US)

(\*\*) Term: **14 Years**

(21) Appl. No.: **29/295,829**

(22) Filed: **Oct. 8, 2007**

**Related U.S. Application Data**

(62) Division of application No. 29/247,116, filed on May  
31, 2006.

(51) **LOC (8) Cl.** ..... **23-01**

(52) **U.S. Cl.** ..... **D23/225**

(58) **Field of Classification Search** ..... D23/213,  
D23/225; 417/411; 222/333; 239/337,  
239/DIG. 14

See application file for complete search history.

(56) **References Cited**

**U.S. PATENT DOCUMENTS**

D286,426 S \* 10/1986 Lin ..... D23/225

D307,463 S \* 4/1990 Fushiya et al. .... D23/225  
D490,500 S \* 5/2004 Ye et al. .... D23/225  
D503,213 S \* 3/2005 Stevens et al. .... D23/225  
D503,215 S \* 3/2005 Stevens et al. .... D23/225

\* cited by examiner

*Primary Examiner*—Robin V Webster

(74) *Attorney, Agent, or Firm*—Faegre & Benson LLP

(57) **CLAIM**

The ornamental design for a cup paint gun, as shown and  
described.

**DESCRIPTION**

FIG. 1 is a perspective view of a cup paint gun of the present  
invention.

FIG. 2 is a left side view of the cup paint gun.

FIG. 3 is a right side view of the cup paint gun.

FIG. 4 is a front view of the cup paint gun.

FIG. 5 is a rear view of the cup paint gun.

FIG. 6 is a top view of the cup paint gun; and,

FIG. 7 is a bottom view of the cup paint gun.

The broken line showing of the power cord is included for  
the purpose of illustrating portions of the paint gun and  
forms no part of the claimed design.

**1 Claim, 7 Drawing Sheets**

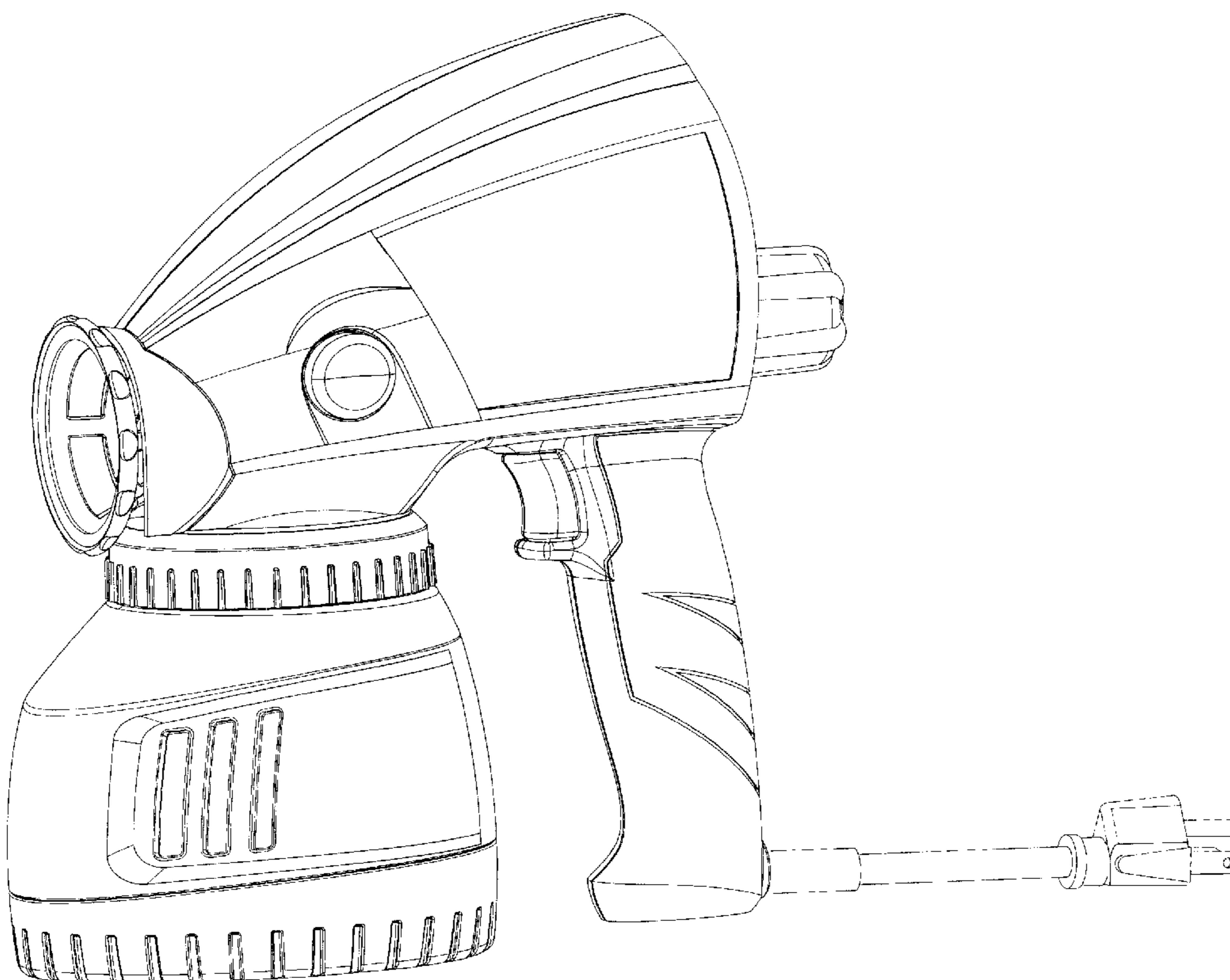

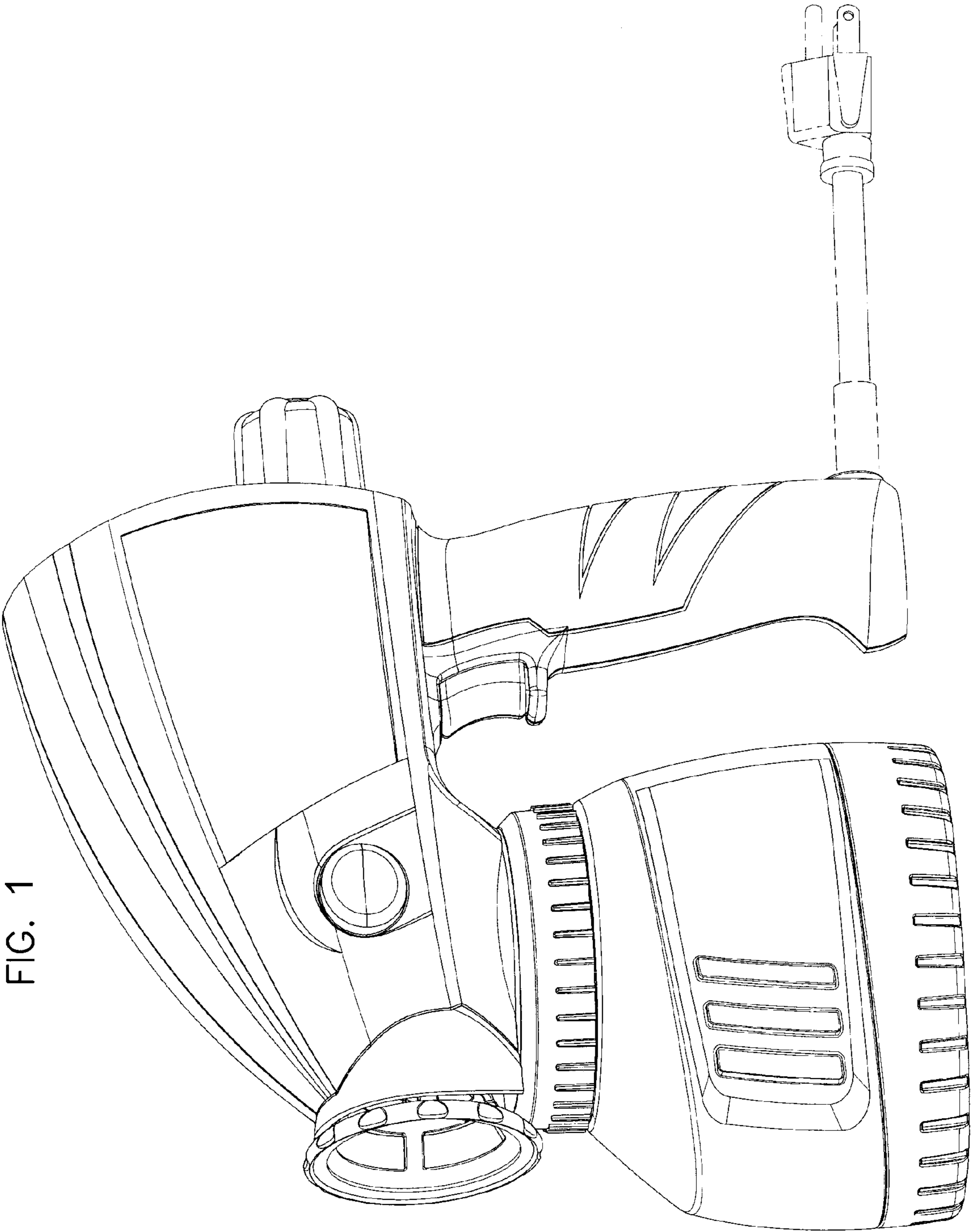

FIG. 1

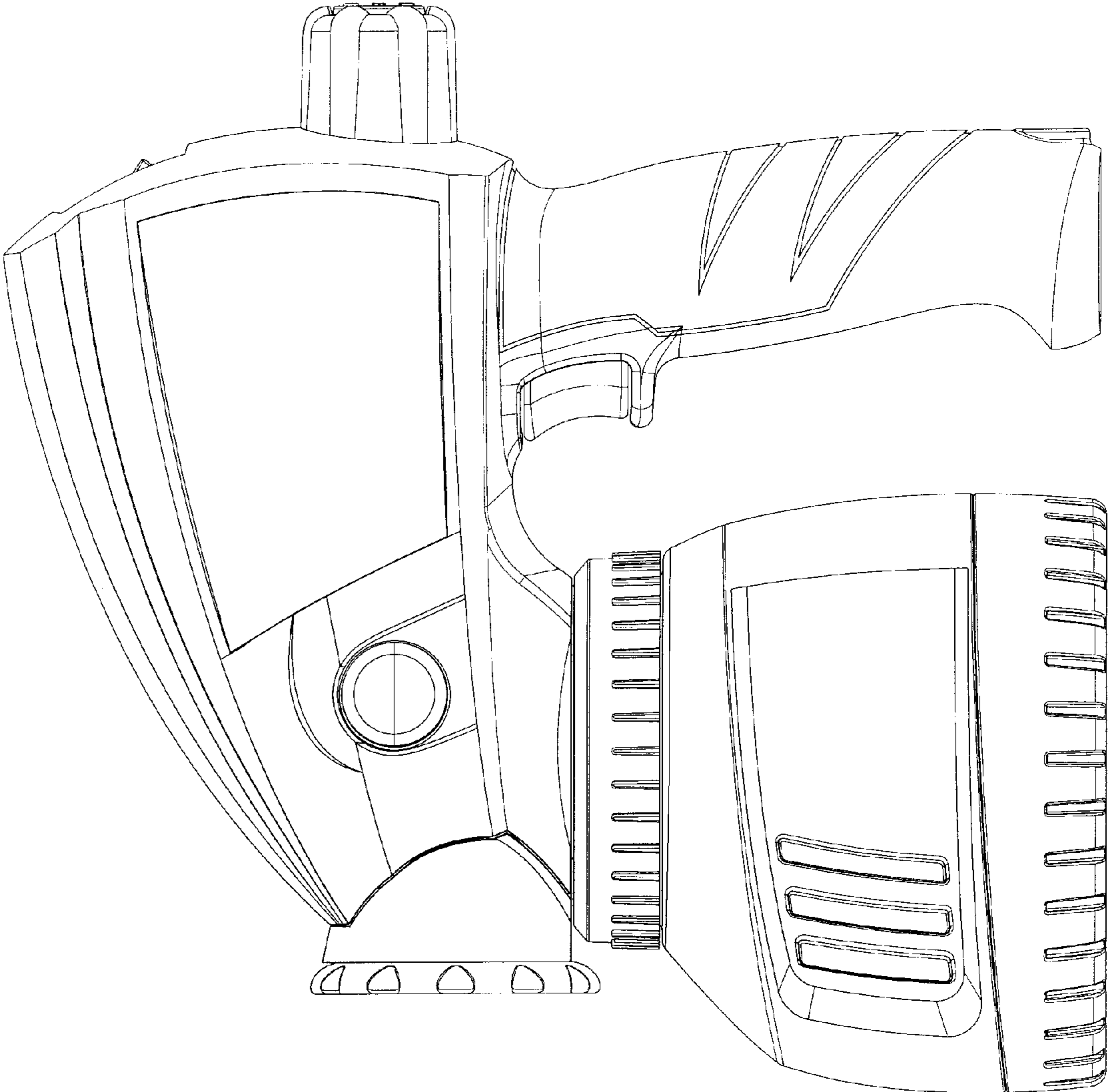

FIG. 2

FIG. 3

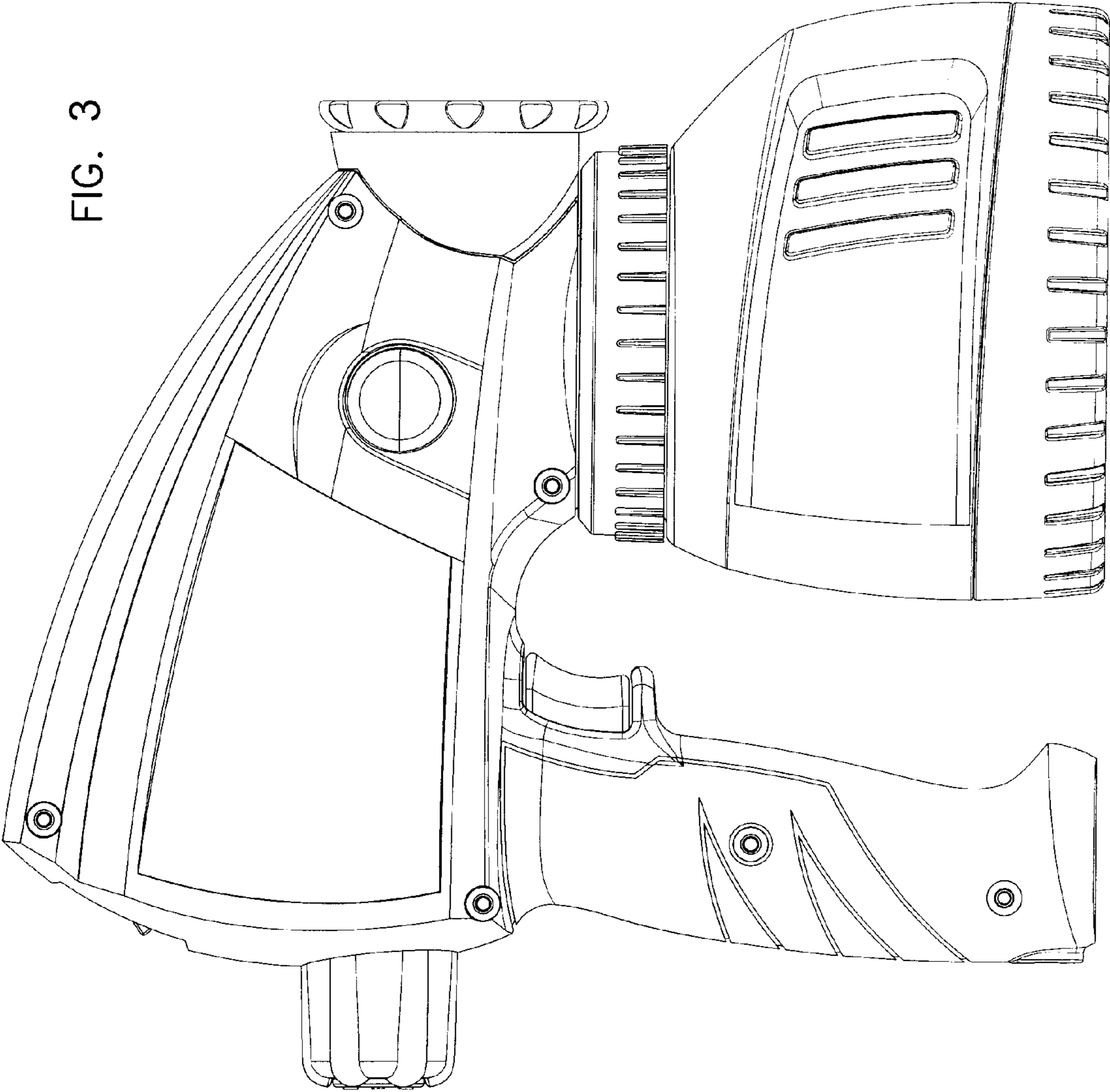



FIG. 4

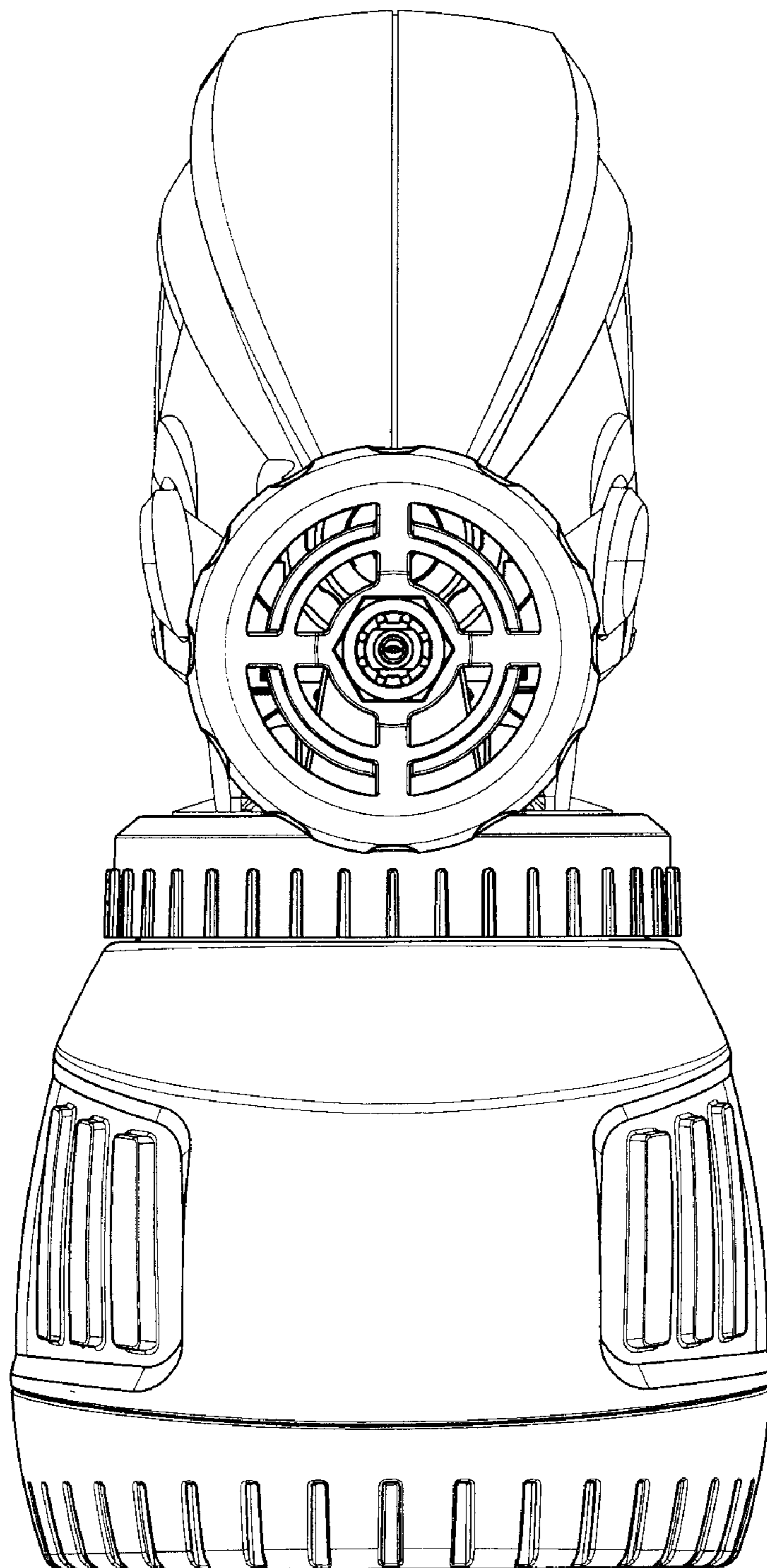

FIG. 5

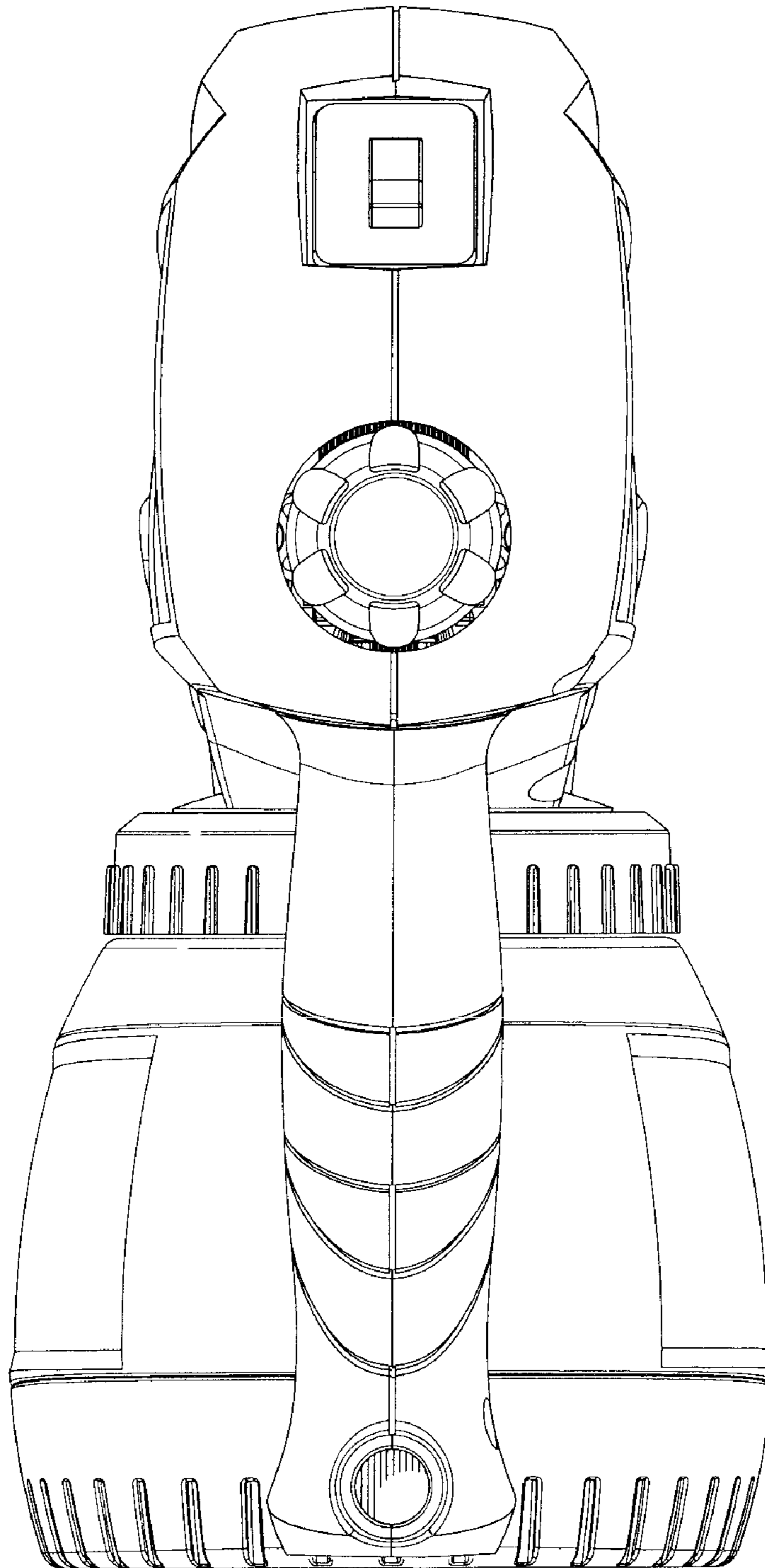

FIG. 6

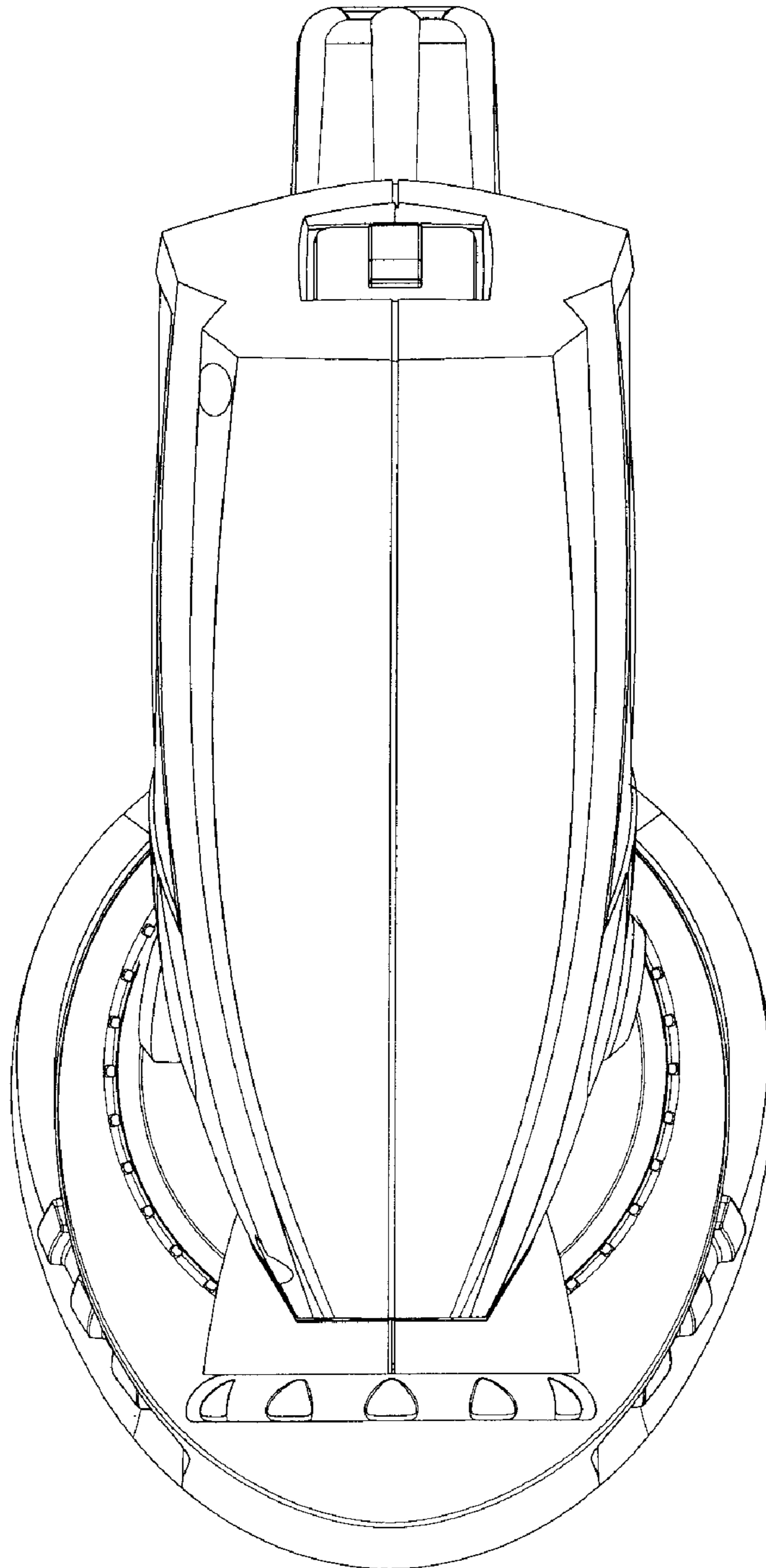

FIG. 7

