



US00D564554S

(12) **United States Design Patent**  
**Shih et al.**

(10) **Patent No.:** **US D564,554 S**

(45) **Date of Patent:** **\*\* Mar. 18, 2008**

(54) **DIGITAL MICROSCOPE**

(75) Inventors: **Ming-Feng Shih**, Kaohsiung (TW);  
**Chung-Min Huang**, Kaohsiung (TW);  
**Hsiu-Yen Tsai**, Yongkang (TW);  
**Cheng-Chi Wu**, Kaohsiung (TW);  
**Jin-Tang Fang**, Kaohsiung (TW);  
**Ming-Lun Hsieh**, Kaohsiung (TW)

(73) Assignee: **Mikrolinks Technology Corp.**, Sinsing  
Dist., Kaohsiung (TW)

(\*\*) Term: **14 Years**

(21) Appl. No.: **29/272,330**

(22) Filed: **Feb. 5, 2007**

(51) **LOC (8) Cl.** ..... **16-06**

(52) **U.S. Cl.** ..... **D16/131**

(58) **Field of Classification Search** ..... D16/130,  
D16/131; D14/156, 167, 192, 218, 168,  
D14/247, 496; D10/104; 359/368, 369,  
359/377, 379, 385; 345/156

See application file for complete search history.

(56) **References Cited**

**U.S. PATENT DOCUMENTS**

3,582,181 A \* 6/1971 Manau de Chveca ..... 359/379  
4,361,377 A \* 11/1982 Pullen ..... 359/385  
5,062,697 A \* 11/1991 Mitchell ..... 359/379

D349,295 S \* 8/1994 Weidemann ..... D16/131  
D382,272 S \* 8/1997 Shiono ..... D14/218  
D479,712 S \* 9/2003 Ng ..... D14/156  
D489,052 S \* 4/2004 Shiraki et al. .... D14/156  
7,046,230 B2 \* 5/2006 Zadesky et al. .... 345/156  
D533,566 S \* 12/2006 Lee ..... D14/496  
D537,459 S \* 2/2007 Yip et al. .... D16/131  
D550,654 S \* 9/2007 Miyawaki ..... D14/218

\* cited by examiner

*Primary Examiner*—Paula A. Greene

(74) *Attorney, Agent, or Firm*—Charles E. Baxley

(57) **CLAIM**

The ornamental design for a digital microscope, as shown.

**DESCRIPTION**

FIG. 1 is a perspective view of a digital microscope showing my new design;

FIG. 2 is a front view thereof;

FIG. 3 is a rear view thereof;

FIG. 4 is a left side view thereof;

FIG. 5 is a right side view thereof;

FIG. 6 is a top view thereof;

FIG. 7 is a bottom view thereof; and,

FIG. 8 is another perspective view thereof.

**1 Claim, 6 Drawing Sheets**

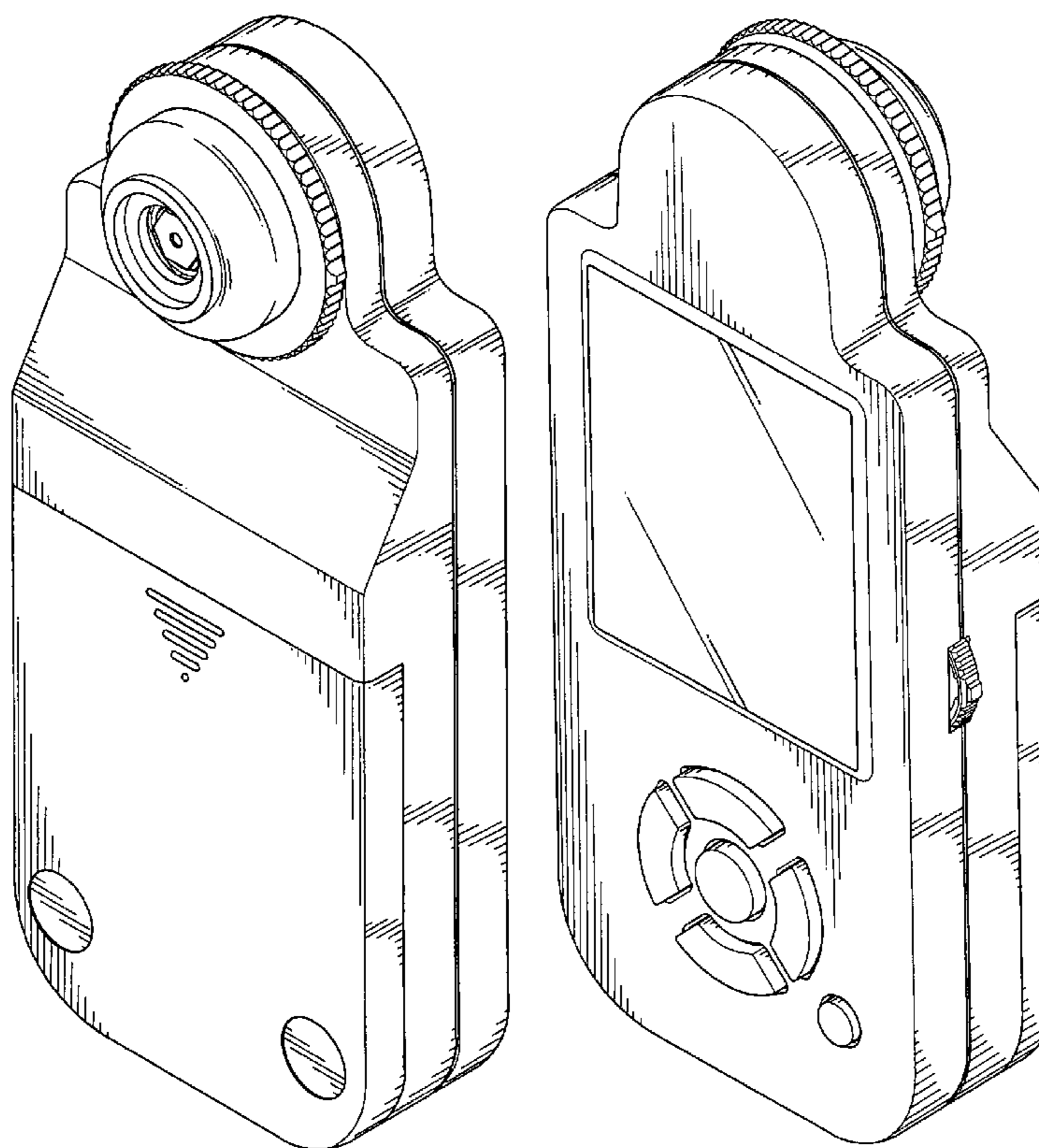

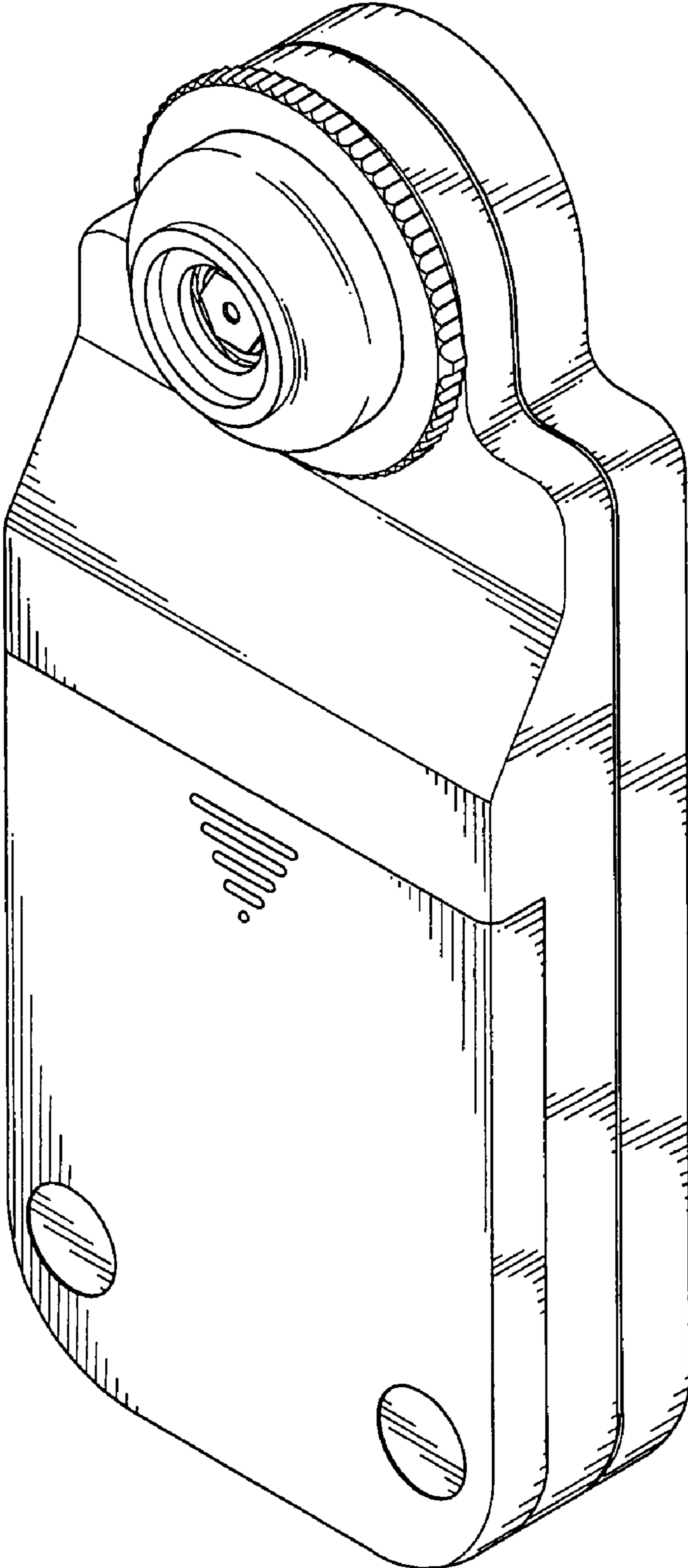

FIG.1

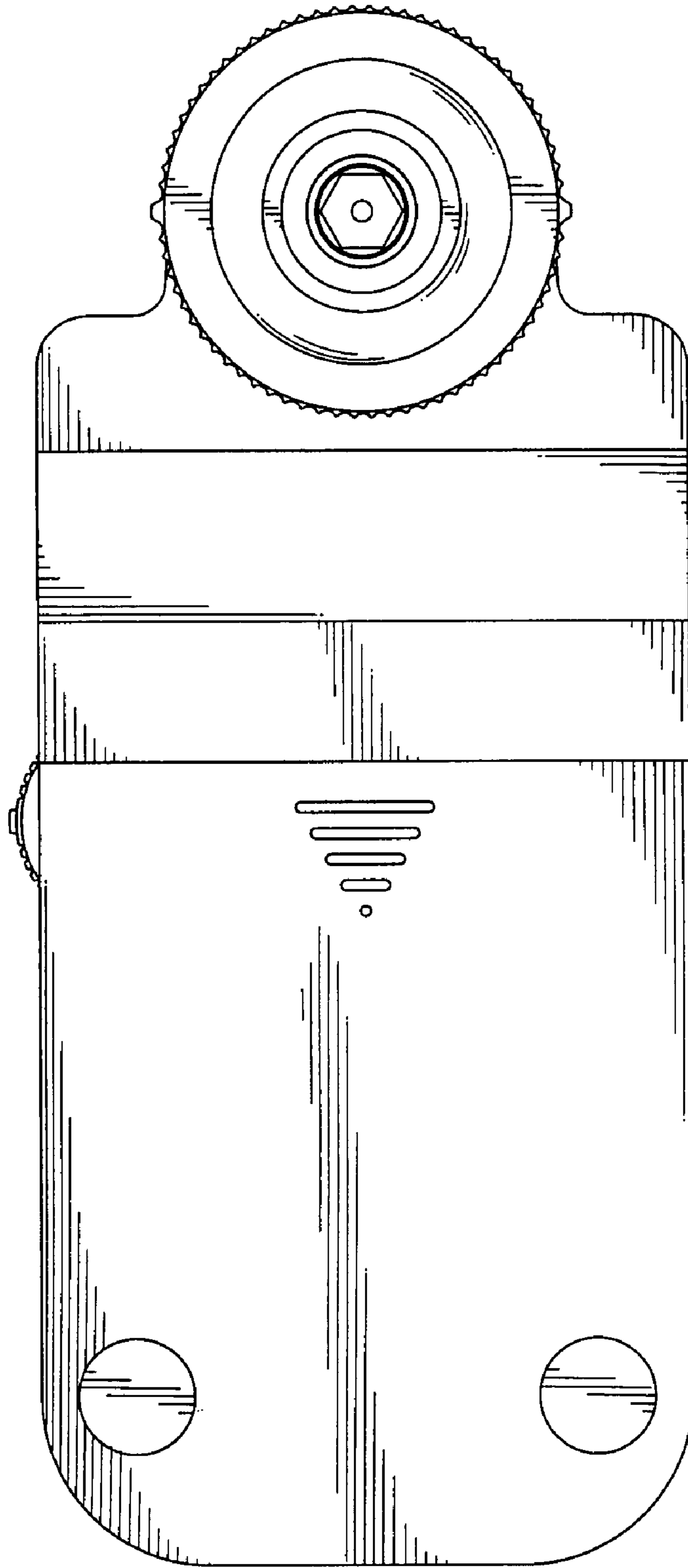

FIG.2

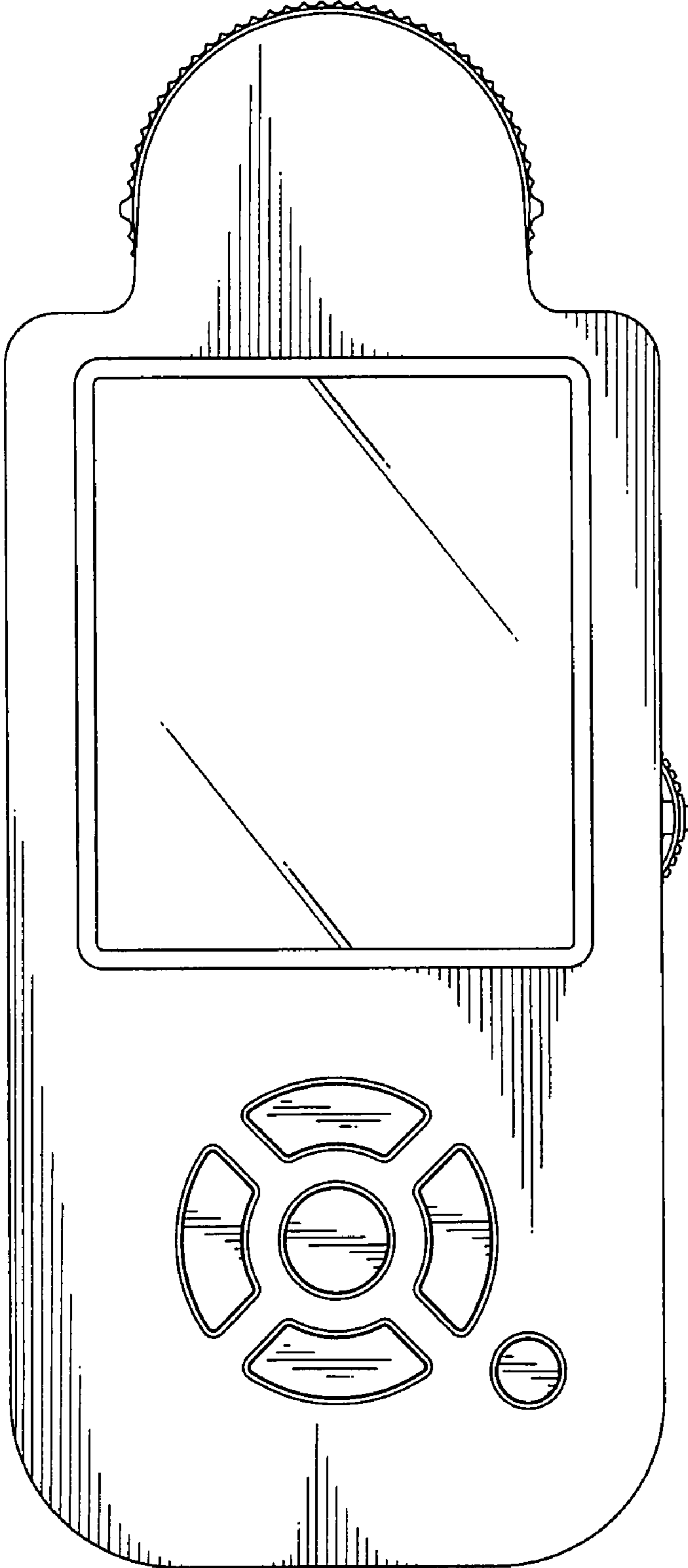

FIG.3

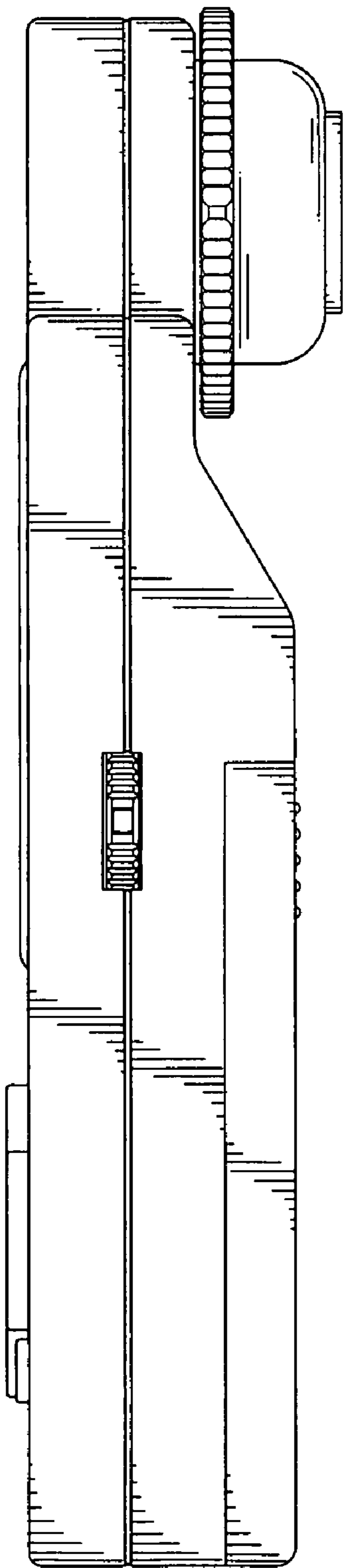

FIG. 4

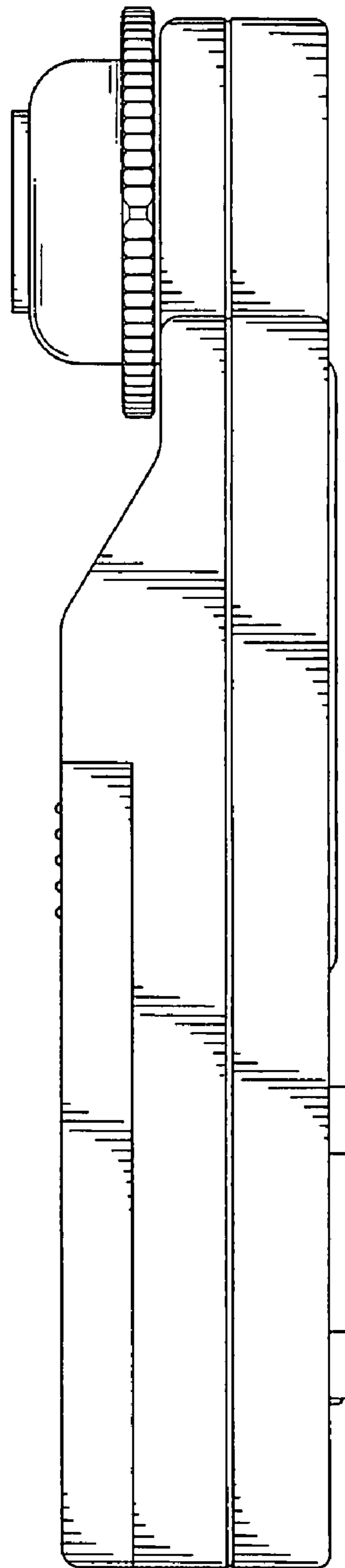

FIG. 5

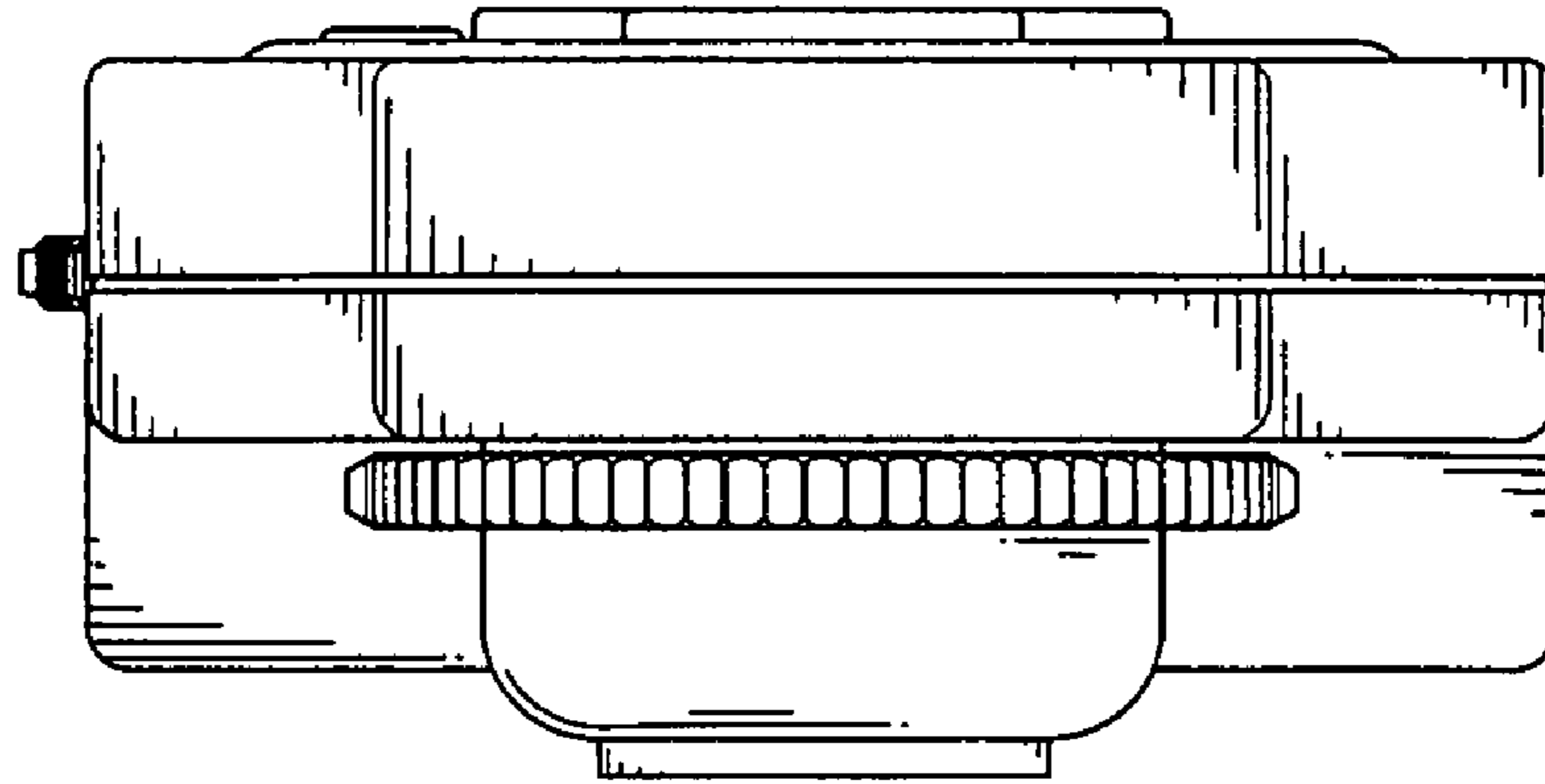

FIG. 6

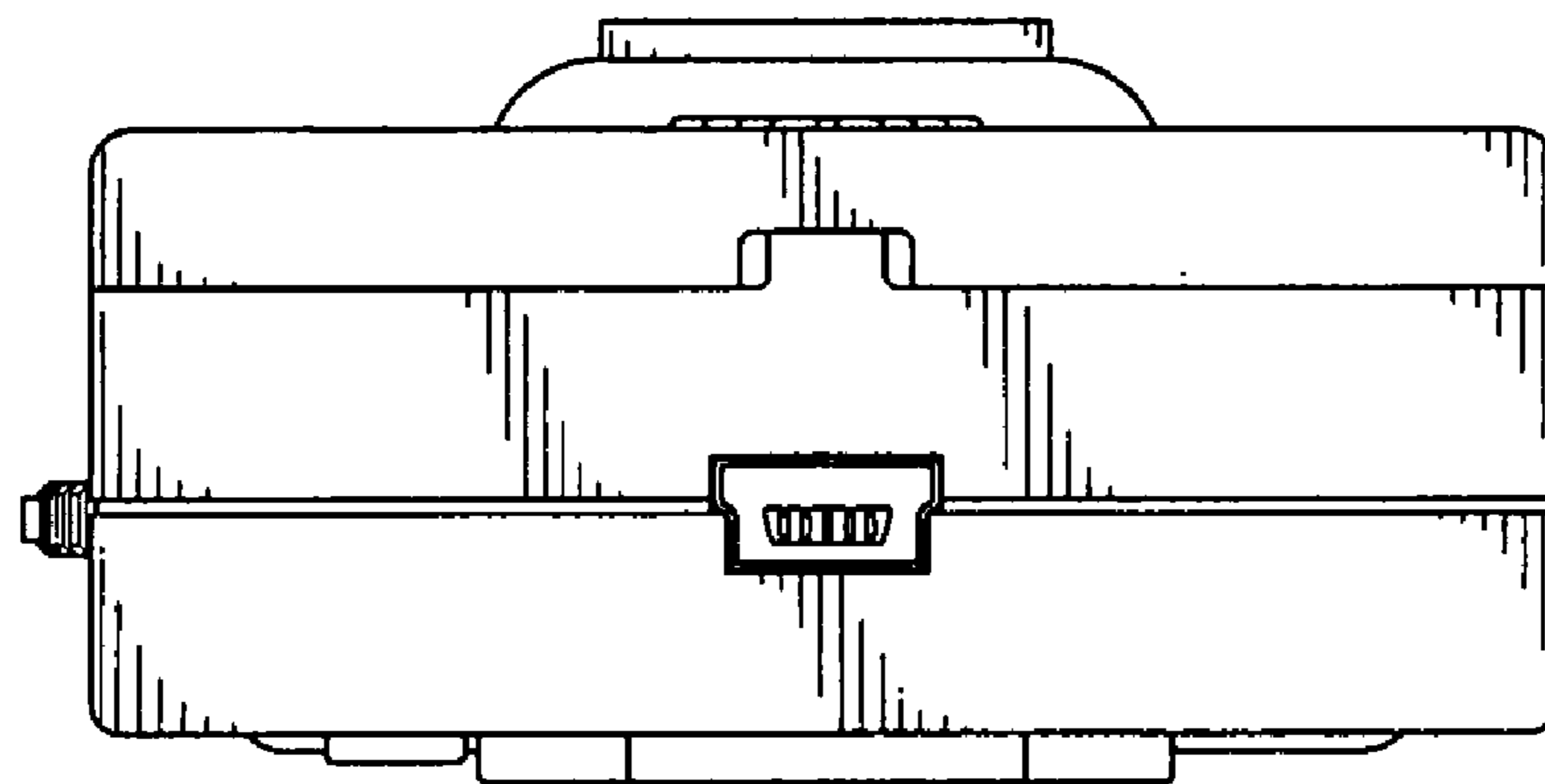

FIG. 7

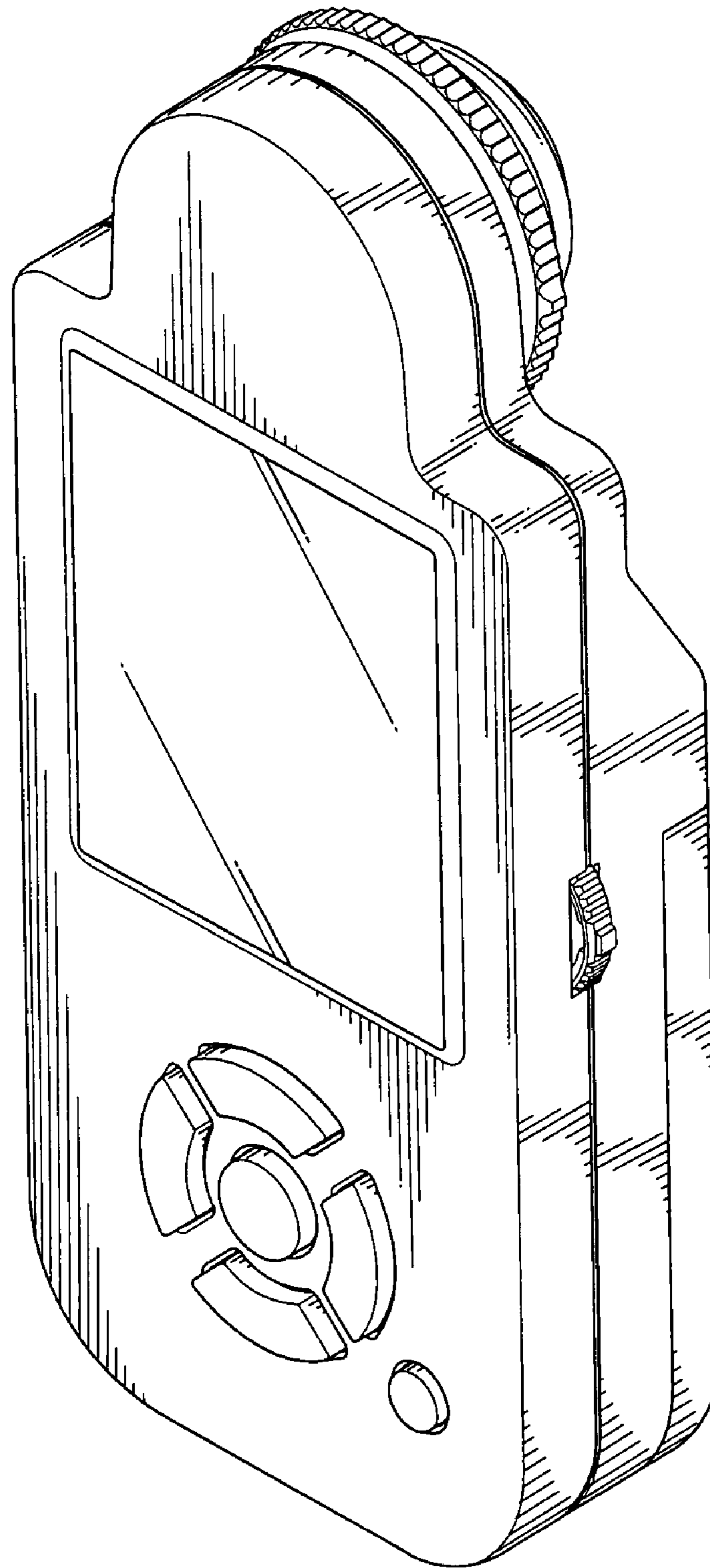

FIG.8

UNITED STATES PATENT AND TRADEMARK OFFICE  
**CERTIFICATE OF CORRECTION**

PATENT NO. : D564,554 S  
APPLICATION NO. : 29/272330  
DATED : March 18, 2008  
INVENTOR(S) : Ming-Feng Shih et al.

Page 1 of 1

It is certified that error appears in the above-identified patent and that said Letters Patent is hereby corrected as shown below:

Title Page item 73 "Mikrolinks" should be -- Microlinks --.

Signed and Sealed this  
Twenty-eighth Day of December, 2010

A handwritten signature in black ink that reads "David J. Kappos". The signature is written in a cursive, slightly slanted style.

David J. Kappos  
*Director of the United States Patent and Trademark Office*